

NRB
INDUSTRIAL

**SINGLE ROW ANGULAR
CONTACT BALL BEARINGS**



MOVING THE WHEELS OF INDUSTRY

SINGLE ROW ANGULAR CONTACT BALL BEARING

DESIGN & FEATURES

Single row angular contact ball bearings are self-retaining units with solid inner rings, outer rings, balls and cage assemblies. Since, these bearings have a contact angle, they can sustain significant unidirectional axial load together with radial load.

Due to its design, an axial force component is produced when a radial load is applied. As a result, two opposite or combination of more than two bearings must be used. Bearings with suffix E are designed for higher load ratings and better performance.

Since the rigidity of single row angular contact bearings increases by preloading, these bearings can be used in applications like machine tool spindles where high running accuracy is required.



Races and ball: Inner, outer races and balls are manufactured from high quality bearing steel (SAE 52100) for optimum performance

Cages: Usually glass fiber filled polyamide cages are used in 40° contact angle (B suffix) bearings. Depending on the application, steel and brass cages are also used. In such cases for the same bearing, the number of balls can vary and accordingly load ratings can also vary.

Bearings with suffix TN have glass fiber filled polyamide cage. There is no suffix for steel cage. For the polyamide cage maximum working temperature is 120°C.

Sealing: Bearings with RS/2RS suffix have contact lip seal on one side/ both sides respectively to protect against atmosphere, contamination and dust.

Lubrication: Bearing with both side seals are filled with high quality grease for life time lubrication. Open bearings and one side sealed bearings are not provided with lubricant. They can be lubricated with grease or oil.

EQUIVALENT LOAD

DYNAMIC EQUIVALENT LOAD

$$P = XFr + YFa$$

Contact Angle	e	Single Row			
		Fa/Fr ≤ e		Fa/Fr ≥ e	
α°		X	Y	X	Y
40°	1.14	1	0	0.35	0.57

STATIC EQUIVALENT LOAD

$$P_s = X_s Fr + Y_s Fa$$

Contact Angle	Single Row	
	X _s	Y _s
40°	0.5	0.26

SINGLE ROW ANGULAR CONTACT BALL BEARING

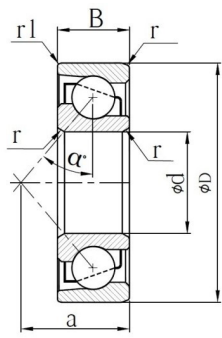

72...BE

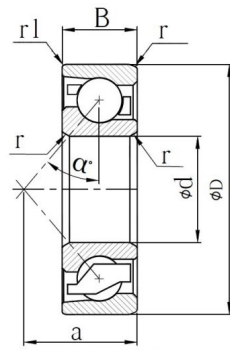

72...BETN

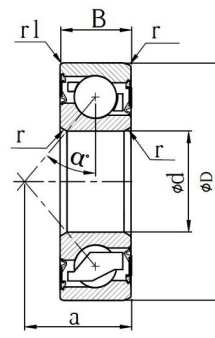

72...BETN-2RS

DIMENSIONAL TABLE

$\alpha^\circ=40$

All Dimensions are in mm

Designation	d	D	B	r _{min}	r1 _{min}	a	BASIC LOAD RATING		MASS (KG)	LIMITING SPEED	
							DYNAMIC CR (N)	STATIC COR (N)		Oil (rpm)	Grease (rpm)
7200 BE	10	30	9	0.6	0.3	13	6960	3280	0.033	32000	22000
7200 BETN	10	30	9	0.6	0.3	13	6960	3280	0.032	32000	22000
7200 BETN-2RS	10	30	9	0.6	0.3	13	6960	3280	0.032	-	15000
7201 BE	12	32	10	0.6	0.3	14	7530	3780	0.038	28000	21000
7201 BETN	12	32	10	0.6	0.3	14	7530	3780	0.035	28000	21000
7201 BETN-2RS	12	32	10	0.6	0.3	14	7530	3780	0.036	-	14000
7202 BE	15	35	11	0.6	0.3	16	8940	4850	0.047	24000	18000
7202 BETN	15	35	11	0.6	0.3	16	8940	4850	0.044	24000	18000
7202 BETN-2RS	15	35	11	0.6	0.3	16	8940	4850	0.044	-	12000
7203 BE	17	40	12	0.6	0.3	18	10350	5550	0.069	22000	17000
7203 BETN	17	40	12	0.6	0.3	18	10350	5550	0.065	22000	17000
7203 BETN-2RS	17	40	12	0.6	0.3	18	10350	5550	0.066	-	11000
7204 BE	20	47	14	1.0	0.6	21	14820	8200	0.111	20000	15000
7204 BETN	20	47	14	1.0	0.6	21	14820	8200	0.104	20000	15000
7204 BETN-2RS	20	47	14	1.0	0.6	21	14820	8200	0.105	-	9000
7205 BE	25	52	15	1.0	0.6	24	15800	9500	0.135	16000	13500
7205 BETN	25	52	15	1.0	0.6	24	15800	9500	0.127	16000	13500
7205 BETN-2RS	25	52	15	1.0	0.6	24	15800	9500	0.127	-	8000
7206 BE	30	62	16	1.0	0.6	27	22600	14390	0.202	14000	11000
7206 BETN	30	62	16	1.0	0.6	27	22600	14390	0.196	14000	11000
7206 BETN-2RS	30	62	16	1.0	0.6	27	22600	14390	0.203	-	6200

SINGLE ROW ANGULAR CONTACT BALL BEARING

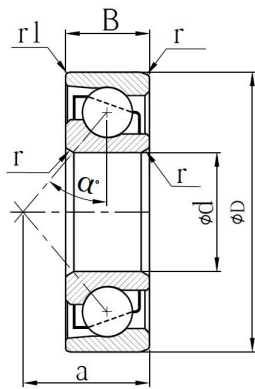

72...BE

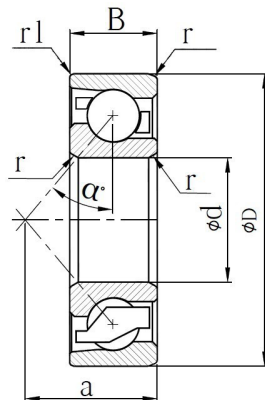

72...BETN

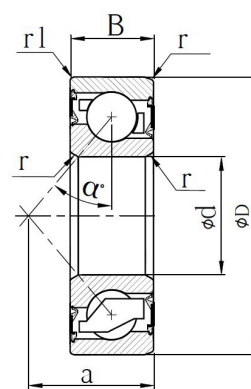

72...BETN-2RS

DIMENSIONAL TABLE

$\alpha^\circ=40$

All Dimensions are in mm

Designation	d	D	B	r min	r1 min	a	BASIC LOAD RATING		MASS (KG)	LIMITING SPEED	
							DYNAMIC CR (N)	STATIC COR (N)		Oil (rpm)	Grease (rpm)
7207 BE	35	72	17	1.1	0.6	31	29180	19140	0.3	12000	9100
7207 B ETN	35	72	17	1.1	0.6	31	29180	19140	0.282	12000	9100
7207 BETN-2RS	35	72	17	1.1	0.6	31	29180	19140	0.282	-	5500
7208 BE	40	80	18	1.1	0.6	34	34490	24000	0.387	11000	8300
7208 BETN	40	80	18	1.1	0.6	34	34490	24000	0.367	11000	8300
7208 BETN-2RS	40	80	18	1.1	0.6	34	34490	24000	0.367	-	5000
7209 BE	45	85	19	1.1	0.6	37	36050	26300	0.428	9500	7400
7209 BETN	45	85	19	1.1	0.6	37	36050	26300	0.405	9500	7400
7210 BE	50	90	20	1.1	0.6	39	37430	28540	0.493	9000	6500
7210 BETN	50	90	20	1.1	0.6	39	37430	28540	0.458	9000	6500
7211 BE	55	100	21	1.5	1.0	43	48260	38500	0.645	8200	6000
7211 BETN	55	100	21	1.5	1.0	43	48260	38500	0.604	8200	6000
7212 BE	60	110	22	1.5	1.0	47	57850	45780	0.847	7500	5700
7212 BETN	60	110	22	1.5	1.0	47	57860	45780	0.78	7500	5700
7213 BE	65	120	23	1.5	1.0	51	66380	54000	1.08	6000	5200
7213 BETN	65	120	23	1.5	1.0	51	66380	54000	1.0	6000	5200

SINGLE ROW ANGULAR CONTACT BALL BEARING

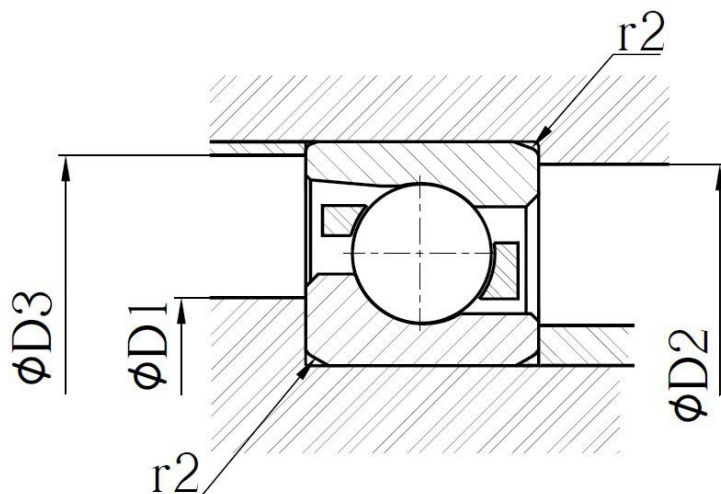

All Dimensions are in mm

Designation			Abutment and fillet dimensions			
			D1 (min)	D2 (min)	D3 (max)	r2 (max)
7200 BE	7200 BETN	7200 BETN-2RS	14.2	25.8	27.6	0.6
7201 BE	7201 BETN	7201 BETN-2RS	16.2	27.8	29.6	0.6
7202 BE	7202 BETN	7202 BETN-2RS	19.2	30.8	32.6	0.6
7203 BE	7203 BETN	7203 BETN-2RS	21.2	35.8	37.6	0.6
7204 BE	7204 BETN	7204 BETN-2RS	25.6	41.8	42.8	1.0
7205 BE	7205 BETN	7205 BETN-2RS	30.6	46.4	47.8	1.0
7206 BE	7206 BETN	7206 BETN-2RS	35.6	56.4	57.8	1.0
7207 BE	7207 BETN	7207 BETN-2RS	42	65	67.8	1.0
7208 BE	7208 BETN	7208 BETN-2RS	47	73	75.8	1.0
7209 BE	7209 BETN	-	52	78	80.8	1.0
7210 BE	7210 BETN	-	61	83	85.8	1.0
7211 BE	7211 BETN	-	64	91	94.4	1.5
7212 BE	7212 BETN	-	69	101	104.4	1.5
7213 BE	7213 BETN	-	74	111	114.4	1.5

SINGLE ROW ANGULAR CONTACT BALL BEARING

APPLICATIONS

NRB Industrial's Angular Contact Ball Bearings are designed for a range of industrial applications.



Textile Machinery



Pumps

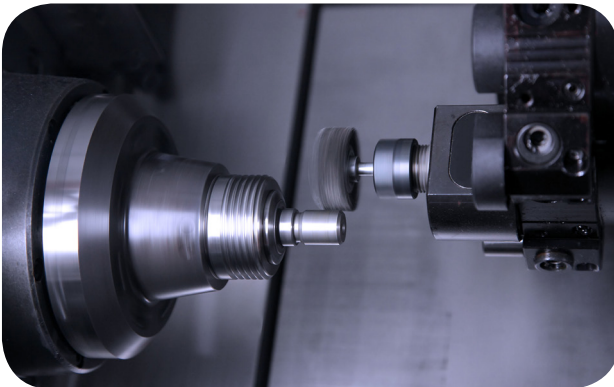

Machine Tools

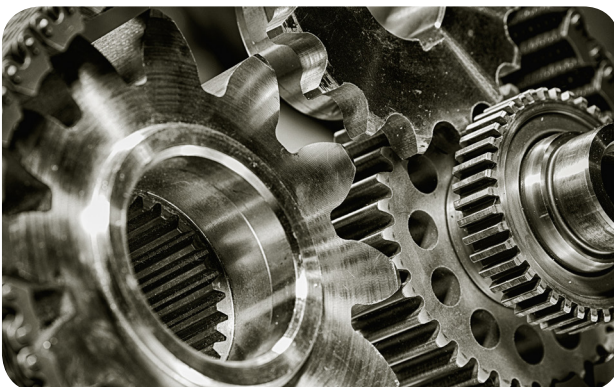

Industrial Transmission

WHY NRB INDUSTRIAL?

NRB Industrial is India's leading manufacturer of bearings and related accessories. Backed by a state-of-the-art manufacturing facility in Shendra, Aurangabad, regional offices in all major cities and a strong distribution network across India, we serve all industry segments.

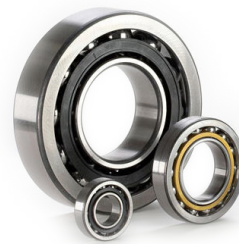
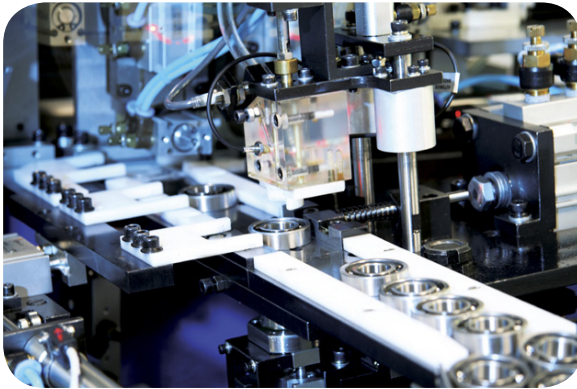

NRB INDUSTRIAL ACBB offers:

- ✓ Long Lasting Performance
- ✓ High load carrying capacity
- ✓ High degree of running accuracy
- ✓ High speed
- ✓ High degree of stiffness





NOTES

.....

.....

.....

.....

.....

.....

.....

.....

.....

.....

.....

.....

.....

.....

.....

.....

.....

.....

.....

.....

.....

.....

.....

.....



NRB INDUSTRIAL BEARINGS LTD

REGD OFFICE

DHANNUR, 2ND FLOOR, 15, SIR P.M. ROAD, FORT, MUMBAI - 400001 INDIA

Tel: (022) 6120 7500, 2270 4206 FAX: (022) 2270 4207

PLANT

PLOT N. B-18, FIVE STAR M.I.D.C. AREA, SHENDRA, AURANGABAD- 431201

TEL: (0240) 2622180

E-mail: marketing@nibl.in

Website: www.nrbindustrialbearings.com