

TIMKEN



TIMKEN® TAPERED ROLLER BEARING CATALOG



TAPERED ROLLER BEARING CATALOG INDEX

TIMKEN OVERVIEW	2
SHELF LIFE POLICY	7
INTRODUCTION	8
ENGINEERING	
Tapered Roller Bearing Types and Cages	12
Determination of Applied Loads and Bearing Analysis Symbols ..	15
Metric System Tolerances	17
Inch System Tolerances	26
Tapered Roller Bearing Mounting Designs, Fitting Practices and Setting	32
Fitting Practice Tables	38
Operating Temperatures	53
Heat Generation and Dissipation	56
Torque	57
Lubrication	61
TAPERED ROLLER BEARINGS	
Part-Numbering Systems	72
Radial Roller Bearings	
Single-Row	
TS	87
IsoClass	399
TSF	423
TSL	495
Double-Row	
TDO	499
TDI	599
TDIT	630
TNA	637
TNASW	649
TNASWE	654
2TS-IM	659
2TS-DM	688
2S	712
SR	716
Tapered Roller Thrust Bearings	723
Part-Numbering Systems	726
TTHD	727
TTHDFL	728
TTVS	730
TTSP	731
TTC, TTCS, TTCL	734
Auxiliary Parts	737
INDEX	747



GROW STRONGER WITH TIMKEN

Every day, people around the world count on the strength of Timken. Our expertise in metallurgy, friction management and mechanical power transmission helps them accelerate improvements in productivity and uptime.

We supply products and services that can help keep your operations moving forward, whether you need drive train kits for commercial vehicles, durable housings for bearings in dirty environments, couplings that avoid metal-to-metal contact between motors and gearboxes, repair services for bearings and gearboxes, roller chain for dry, abrasive and high-moisture applications or other products or services for your applications.

When you choose Timken, you receive more than high-quality products and services: you gain a worldwide team of highly trained and experienced Timken people committed to working collaboratively with you to improve your business.

Globally, our 17,000 people provide reliable answers for a wide range of operations in manufacturing, mining, medical equipment, aerospace, transportation, oil and gas – and other diverse industries.



INCREASE YOUR EQUIPMENT UPTIME

In addition to high-quality bearings and mechanical power transmission components, we provide valuable integrated products and services. For example, we offer repair services and monitoring equipment that can alert you to problems before they impact your uptime.

Additionally, we offer a broad selection of seals, premium lubricants, lubricators, couplings and chain to keep your operations moving smoothly.

Our technology centers in the United States, Europe and Asia help pioneer tomorrow's innovations with extensive basic and applied scientific research programs. Through internal development and strategic acquisition of innovative companies, we continue to expand our portfolio of highly engineered bearings and components.



TIMKEN® TAPERED ROLLER BEARINGS – RELIABILITY, VERSATILITY, CHOICE

Demanding applications call for reliable solutions. Improve your equipment's performance and reduce your downtime and maintenance costs by turning to Timken® tapered roller bearings. When you purchase a Timken® bearing, you're investing in a product that's designed with you in mind.

Reliability. Expert craftsmanship, well-equipped production facilities and an ongoing investment in technology ensure our products are synonymous with quality and reliability. Our tapered roller bearings stand up to extreme situations, including high-corrosive, high-temperature, vacuum or low-lubrication environments.

Versatility. Use Timken tapered roller bearings to help your equipment excel when it faces combined radial and thrust loads. Our bearings are uniquely designed to manage both types of loads on rotating shafts and in housings.

Choice. From single- to double- to four-row configurations to thrust, choose from nearly 26,000 product combinations to find the right bearing for your application.

DESIGN FEATURES

Each tapered roller bearing contains four interdependent components: the cone (inner ring), the cup (outer ring), tapered rollers (rolling elements) and the cage (roller retainer).

Tapered angles allow our bearings to efficiently control a combination of radial and thrust loads. The steeper the outer ring angle, the greater ability the bearing has to handle thrust loads. To provide a true rolling motion of the rollers on the raceways, the extensions of the raceways and the tapered surfaces of the rollers come together at a common point, the apex, on the axis of rotation.

CUSTOMIZATION OPTIONS

For extreme environments, take advantage of our customization options. We can tailor geometries and apply engineered surfaces to help improve performance.

PRODUCT OFFERING

We have the most extensive line of tapered roller bearings available anywhere in the world. Single-, double-, four-row and thrust options are available in sizes ranging from 8 mm (0.31496 in.) bore to > 3000 mm (118 in.) outside diameter (O.D.). Timken has the bearings to fit most applications, including yours. Refer to www.timken.com for four-row information.

Contents of this catalog include:

SINGLE-ROW BEARING TYPES

- TS (pressed steel and pin-type cages)
- TSF (flanged cup)
- TSL (DUO-FACE® Plus Seal)
- IsoClass™ Series

DOUBLE-ROW BEARING TYPES

- TDO (single piece [double] outer ring and two single inner rings)
- TDI (double-row double inner race)
- TDIT (double-row double inner race with tapered bore)
- TDO (double-row double outer-race)
- TNA (double-row non-adjustable)
- TNASW (double-row, non-adjustable with lubricant slots)
- TNASWE (double-row, non-adjustable with lubricant slots and extended back face rib)
- 2TS-IM (two single-row assemblies, indirect mount)
- 2TS-DM (two single-row assemblies, direct mount)
- 2S (two single-row assemblies with snap ring spacer)
- SR (two single row, SET-RIGHT™ assembly)

THRUST BEARING TYPES

- TTHD (heavy duty)
- TTHDFL (flat race)
- TTVS (flat race, self-aligning)
- TTC (light-duty, cageless)
- TTSP (light-duty, with cage)

INDUSTRY PRESENCE

Timken tapered roller bearings effectively reduce friction and help transmit power in industries like:

- Aerospace
- Agriculture
- Automotive
- Heavy truck
- Cement
- Aggregate
- Rail
- Oil and gas
- Construction
- Gear drives
- Machine tools
- Mining
- Paper
- Metals
- Wind and Coal
Power Generation

QUALITY SOLUTIONS

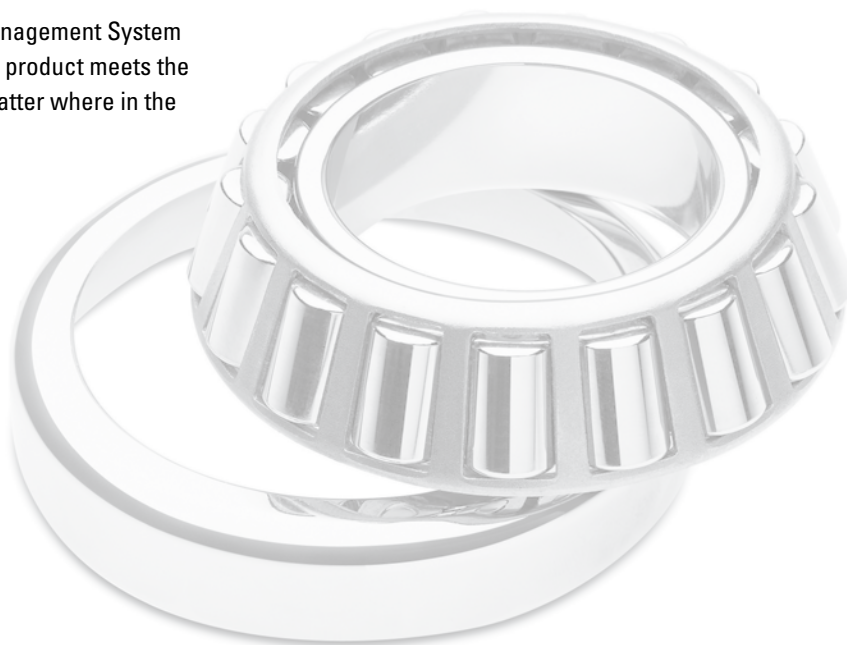
At Timken, our brand stands for outstanding quality in everything we do, from product design and manufacturing to engineering support and distribution. By using clean, high-alloy steel in our tapered roller bearings, we can help ensure the overall quality of our product. We know how critical quality materials are to product performance.

We also implement the Timken Quality Management System in every plant worldwide, so each bearing product meets the same high performance standards – no matter where in the world it is manufactured.

DEPENDABLE SERVICE

Every Timken tapered roller bearing is backed by the service of our industry-leading experts who are ready to assist you with product design, application knowledge and 24/7 field engineering support – anything you need to help improve uptime and maximize equipment performance.

Timken offers a wide range of bearing products for many different industries. A complete listing of our product catalogs can be found at www.timken.com.



HOW TO USE THIS CATALOG

We designed this catalog to help you find the Timken bearings best suited to your equipment needs and specifications.

The product tables list many of the bearing types that are specifically used in thrust positions. For other bearing types, please refer to the respective Timken product catalog reference.

Timken offers an extensive range of bearings and accessories in both imperial and metric sizes. For your convenience, size ranges are indicated in millimeters and inches. Contact your Timken engineer to learn more about our complete line for the special needs of your application.

This publication contains dimensions, tolerances and load ratings, as well as engineering sections describing mounting and fitting practices for shafts and housings, internal clearances, materials and other bearing features. It provides valuable assistance in the initial consideration of the type and characteristics of the bearings that may best suit your particular needs.

ISO and ANSI/ABMA, as used in this publication, refer to the International Organization for Standardization and the American National Standards Institute/American Bearing Manufacturers Association.



SHELF LIFE AND STORAGE OF GREASE-LUBRICATED BEARINGS AND COMPONENTS

To help you get the most value from our products, Timken provides guidelines for the shelf life of grease-lubricated ball and roller bearings, components and assemblies. Shelf life information is based on Timken and industry test data and experience.

SHELF LIFE POLICY

Shelf life should be distinguished from lubricated bearing/component design life as follows:

- Shelf life of the grease-lubricated bearing/component represents the period of time prior to use or installation.
- The shelf life is a portion of the anticipated aggregate design life. It is impossible to accurately predict design life due to variations in lubricant bleed rates, oil migration, operating conditions, installation conditions, temperature, humidity and extended storage.
- Shelf life values, available from Timken, represent a maximum limit and assume adherence to the storage and handling guidelines suggested in this catalog or by a Timken associate. Deviations from the Timken storage and handling guidelines may reduce shelf life. Any specification or operating practice that defines a shorter shelf life should be used.

Timken cannot anticipate the performance of the grease lubricant after the bearing or component is installed or placed in service.

TIMKEN IS NOT RESPONSIBLE FOR THE SHELF LIFE OF ANY BEARING/COMPONENT LUBRICATED BY ANOTHER PARTY

European REACH compliance

Timken-branded lubricants, greases and similar products sold in stand-alone containers or delivery systems are subject to the European REACH (Registration, Evaluation, Authorization and Restriction of CHemicals) directive. For import into the European Union, Timken can sell and provide only those lubricants and greases that are registered with ECHA (European CHemical Agency). For further information, please contact your Timken engineer.

STORAGE

Timken suggests the following storage guidelines for its finished products (bearings, components and assemblies, hereinafter referred to as "Products"):

- Unless directed otherwise by Timken, products should be kept in their original packaging until they are ready to be placed into service.
- Do not remove or alter any labels or stencil markings on the packaging.
- Products should be stored in such a way that the packaging is not pierced, crushed or otherwise damaged.
- After a product is removed from its packaging, it should be placed into service as soon as possible.

- When removing a product that is not individually packaged from a bulk pack container, the container should be resealed immediately after the product is removed.
- Do not use product that has exceeded its shelf life as defined in the Timken shelf life guidelines statement.
- The storage area temperature should be maintained between 0° C (32° F) and 40° C (104° F); temperature fluctuations should be minimized.
- The relative humidity should be maintained below 60 percent and the surfaces should be dry.
- The storage area should be kept free from airborne contaminants such as, but not limited to, dust, dirt, harmful vapors, etc.
- The storage area should be isolated from undue vibration.
- Extreme conditions of any kind should be avoided.

Due to the fact that Timken is not familiar with your particular storage conditions, we strongly suggest following these guidelines. However, you may be required by circumstances or applicable government requirements to adhere to stricter storage requirements.

Most bearing components typically ship protected with a corrosion-preventive compound that is not a lubricant. These components may be used in oil-lubricated applications without removal of the corrosion-preventive compound. When using some specialized grease lubrications, we advise you to remove the corrosion-preventive compound before packing the bearing components with suitable grease.



Be careful in selecting lubrication, however, since different lubricants are often incompatible.

When you receive a bearing shipment, do not remove products from their packaging until they are ready for mounting so they do not become corroded or contaminated.

Store bearings and bearing housings in an appropriate atmosphere so they remain protected for the intended period.

⚠ WARNING

Failure to observe the following warnings could create a risk of death or serious injury.

Never spin a bearing with compressed air.
The components may be forcefully expelled.

Proper maintenance and handling practices are critical.
Always follow installation instructions and
maintain proper lubrication

**Warnings for this product line are in this catalog
and posted on [http://www.timken.com/en-us/products/
warnings/Pages/default.aspx](http://www.timken.com/en-us/products/warnings/Pages/default.aspx)**

This information is not intended to substitute for the specific
recommendations of your equipment suppliers.

Every reasonable effort has been made to ensure the accuracy
of the information contained in this writing, but no liability is
accepted for errors, omissions or for any other reason.

DISCLAIMER

This catalog is provided solely to give you analysis tools and data to assist you in your product selection. Product performance is affected by many factors beyond the control of Timken. Therefore, you must validate the suitability and feasibility of all product selections.

***Timken products are sold subject to Timken terms and conditions of sale, which include our limited warranty and remedy. You can find these at [http://www.timken.com/en-us/purchase/Pages/
TermsandConditionsofSale.aspx](http://www.timken.com/en-us/purchase/Pages/TermsandConditionsofSale.aspx).***

Please consult with your Timken engineer for more information and assistance. Every reasonable effort has been made to ensure the accuracy of the information in this writing, but no liability is accepted for errors, omissions or for any other reason.

ENGINEERING

The following topics are covered within this engineering section:

- Tapered roller bearing design types.
- Cage design types.
- Fitting practice and mounting recommendations.
- Lubrication recommendations.

This engineering section is not intended to be comprehensive, but does serve as a useful guide in tapered roller bearing selection.

To view the complete engineering catalog, please visit www.timken.com. To order the catalog, please contact your Timken engineer and request a copy of the Timken Engineering Manual, order number 10424.



TAPERED ROLLER BEARINGS TYPES AND CAGES

SINGLE-ROW BEARINGS

TS - SINGLE-ROW

This is the basic and the most widely used type of tapered roller bearing. It consists of the inner-ring assembly and the outer ring. It is usually fitted as one of an opposing pair. During equipment assembly, single-row bearings can be “set” to the required clearance (endplay) or preload condition to optimize performance.



Fig. 1. Single-row TS bearing.

TSF - SINGLE-ROW, WITH FLANGED OUTER RING

The TSF type is a variation on the basic single-row bearing. TSF bearings have a flanged outer ring to facilitate axial location and accurately aligned seats in a through-bored housing.



Fig. 2. Single-row TSF bearing with flanged outer ring.

DOUBLE-ROW BEARINGS

TDO - DOUBLE OUTER RING

This has a one-piece (double) outer ring and two single inner rings. It is usually supplied complete with an inner-ring spacer as a pre-set assembly. This configuration gives a wide effective bearing spread and is frequently chosen for applications where overturning moments are a significant load component. TDO bearings can be used in fixed (locating) positions or allowed to float in the housing bore, for example, to compensate for shaft expansion. TDOCD outer rings also are available in most sizes. These outer rings have holes in the O.D. that permit the use of pins to prevent outer ring rotation in the housing.



Fig. 3. Double-row TDO bearing.

TDI - DOUBLE INNER RING

TDIT - DOUBLE INNER RING WITH TAPERED BORE

Both comprise a one-piece (double) inner ring and two single outer rings. They are usually supplied complete with an outer-ring spacer as a pre-set assembly. TDI and TDIT bearings can be used at fixed (locating) positions on rotating shaft applications. For rotating housing applications, the double inner ring of type TDI can be used to float on the stationary shaft. Type TDIT has a tapered bore to facilitate removal when an interference fit is essential, yet regular removal is required.



Fig. 4. Double-row, double-inner-ring bearings.

- TNA - NON-ADJUSTABLE**
- TNASW - NON-ADJUSTABLE WITH LUBRICANT SLOTS**
- TNASWE - NON-ADJUSTABLE WITH LUBRICANT SLOTS AND EXTENDED BACK FACE RIB**

These three bearing types are similar to the TDO with a one-piece (double) outer ring and two single inner rings. The inner-ring front faces are extended so they abut, eliminating the need for a separate inner-ring spacer. Supplied with a built-in clearance to give a standard setting range, these bearings provide a solution for many fixed or floating bearing applications where optimum simplicity of assembly is required.

Types TNASW and TNASWE are variations having chamfers and slots on the front face of the inner ring to provide lubrication through the shaft. Type TNASWE have extended back face ribs on the inner rings which are ground on the O.D. to allow for the use of a seal or stamped closure. These designs are typically used on stationary shaft applications.



Fig. 5. Double-row, non-adjustable bearings.

SPACER ASSEMBLIES

Any two single-row bearings (type TS) can be supplied as a double-row, pre-set, ready-to-fit assembly by the addition of spacers, machined to pre-determined dimensions and tolerances.

Spacer assemblies are provided in two types: "2S" and "SR". This concept can be applied to produce custom-made double-row bearings to suit specific applications. In addition to providing a bearing that automatically gives a pre-determined setting at assembly without the need for a manual setting, it is possible to modify the assembly width to suit an application, simply by varying the spacer widths.



Fig. 6. Spacer assemblies.

2S - TWO SINGLE-ROW ASSEMBLY

Often referred to as snap-ring assemblies, type 2S consist of two basic single-row bearings (type TS). They are supplied complete with inner-ring and outer-ring spacers to give a pre-determined bearing setting when assembled. Type 2S have a specified setting range to suit the duty of the application. They have an inner-ring spacer and a snap-ring, which also serves as the outer-ring spacer, to give axial location in a through-bored housing.

SR - SET-RIGHT™ ASSEMBLY

Type SR are made to a standard setting range, based on Timken's SET-RIGHT™ automated setting technique suitable for most industrial applications. They have two spacers and an optional snap-ring that may be used for axial location. Because both types are made up of popular sizes of single-row bearings, they provide a low-cost option for many applications.

There are two basic mounting arrangements for spacer assemblies.

- **Type 2TS-IM (indirect mounting)**
These consist of two single-row bearings with an inner-ring and outer-ring spacer. In some applications, the outer-ring spacer is replaced by a shoulder in the bearing housing.
- **Type 2TS-DM (direct mounting)**
These consist of two single-row bearings, with inner rings abutting and an outer-ring spacer. They are generally used at fixed (locating) positions on rotating shaft applications.

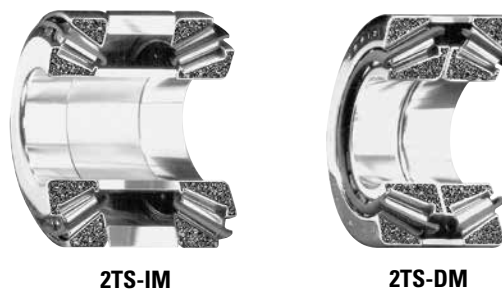


Fig. 7. Basic spacer assemblies.

TAPERED ROLLER BEARING CAGES

STAMPED-STEEL CAGES

The most common type of cage used for tapered roller bearings is the stamped-steel cage. These cages are mass produced from low-carbon sheet steel using a series of cutting, forming and punching operations. These cages can be used in high temperature and harsh lubricant environments.

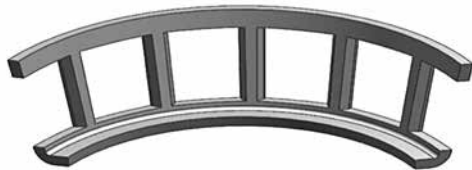


Fig. 8. Stamped-steel cage.

POLYMER CAGES

Cages for tapered roller bearings made of polymer material are used primarily for pre-greased and sealed package designs. The most common polymer materials used are Nylon thermoplastics with glass reinforcement. Polymer cages can be mass produced in large quantities and offer more design flexibility than stamped-steel types. Polymer cages are lightweight and easy to assemble. In some instances, increased bearing rating can be achieved by allowing one or two extra rollers in the bearing complement. Care should be exercised when using aggressive lubricants with EP (extreme-pressure) additives in combination with elevated temperatures greater than 107° C (225° F).

MACHINED CAGES

Machined cages for tapered roller bearings are robust in design and are suited for high-speed and high-load applications. Machined cages use alloy steels and are produced through milling and broaching operations. Assembly does not require a close-in operation and rollers can be retained using nibs or staking. Oil holes also can be easily added for extra lubrication for demanding applications. Some designs are silver plated for special applications.

PIN-TYPE CAGES

Tapered roller bearing pin-type cages retain the rolling elements by the use of a pin located through an axial hole in the center of the roller. Pin-type cages for tapered roller bearings consist of two rings with roller pins attached by screw threads at one end and welding at the other end. These types of cages are primarily used for larger tapered roller bearing designs (greater than 400 mm [15.7480 in.] O.D.). Pin-type cages are machined out of steel and typically allow for an increased number of rolling elements. Pin-type cages are restricted to low-speed applications (less than 20 m/sec [4000 ft/min] rib speed).

DETERMINATION OF APPLIED LOADS AND BEARING ANALYSIS

SUMMARY OF SYMBOLS USED TO DETERMINE APPLIED LOADS AND BEARING ANALYSIS

Symbol	Description	Units (Metric/Inch System)	Symbol	Description	Units (Metric/Inch System)
a	Axial Distance from Inner Ring Backface to Effective Load Center	mm, in.	D _{MG}	Mean or Effective Working Diameter of the Gear	mm, in.
a ₁	Reliability Life Factor	unitless	D _{MP}	Effective Working Diameter of the Pinion	mm, in.
a ₂	Material Life Factor	unitless	D _{MW}	Effective Working Diameter of the Worm	mm, in.
a ₃	Operating Condition Life Factor	unitless	D _{PG}	Pitch Diameter of the Gear	mm, in.
a _{3d}	Debris Life Factor	unitless	D _{PP}	Pitch Diameter of the Pinion	mm, in.
a _{3k}	Load Zone Life Factor	unitless	D _{PW}	Pitch Diameter of the Worm	mm, in.
a _{3l}	Lubrication Life Factor	unitless	e	Life Exponent	unitless
a _{3p}	Low-Load Life Factor	unitless	e	Limiting Value of F _a /F _r for the Applicability of Different Values of Factors X and Y	unitless
a _e	Effective Bearing Spread	mm, in.	E	Free Endplay	mm, in.
A, B, ...	Bearing Position (used as subscripts)	unitless	f	Lubricant Flow Rate	L/min, U.S. pt/min
B	Outer Ring Width	mm, in.	f ₀	Viscous Dependent Torque Coefficient	unitless
B ₁	Inner Ring Width	mm, in.	f ₁	Load Dependent Torque Coefficient	unitless
b	Tooth Length	mm, in.	f _b	Belt or Chain Pull	N, lbf
c _{1, c2}	Linear Distance (positive or negative).	mm, in.	f _n	Speed Factor	unitless
C	Basic Dynamic Radial Load Rating of a Double-Row Bearing for an L ₁₀ of One Million Revolutions	N, lbf	f ₂	Combined Load Factor	unitless
C _{a90}	Basic Dynamic Thrust Load Rating of a Single-Row Bearing for an L ₁₀ of 90 Million Revolutions or 3000 Hours at 500 RPM	N, lbf	f ₃	Combined Load Factor	unitless
C ₀	Basic Static Radial Load Rating	N, lbf	F	General Term for Force	N, lbf
C _{0a}	Basic Static Axial Load Rating	N, lbf	F _{1, F₂, ..., F_n}	Magnitudes of Applied Force During a Loading Cycle	N, lbf
C ₉₀	Basic Dynamic Radial Load Rating of a Single-Row Bearing for an L ₁₀ of 90 Million Revolutions	N, lbf	F _a	Applied Thrust (Axial) Load	N, lbf
C ₉₀₍₂₎	Basic Dynamic Radial Load Rating of a Double-Row Bearing for an L ₁₀ of 90 Million Revolutions	N, lbf	F _{ai}	Induced Thrust (Axial) Load Due to Radial Loading	N, lbf
C _a	Basic Dynamic Axial Load Rating	N, lbf	F _{ac}	Induced Thrust (Axial) Load Due to Centrifugal Loading	N, lbf
C _g	Geometry Factor (used in a _{3l} equation)	unitless	F _{aG}	Thrust Force on Gear	N, lbf
C _l	Load Factor (used in a _{3l} equation)	unitless	F _{aP}	Thrust Force on Pinion	N, lbf
C _j	Load Zone Factor (used in a _{3l} equation)	unitless	F _{aW}	Thrust Force on Worm	N, lbf
C _s	Speed Factor (used in a _{3l} equation)	unitless	F _{az}	Allowable Axial Load	N, lbf
C _v	Viscosity Factor (used in a _{3l} equation)	unitless	F _b	Belt or Chain Pull	N, lbf
C _{gr}	Grease Lubrication Factor (used in a _{3l} equation)	unitless	F _β	Load Term for Torque Equation	N, lbf
C _p	Specific Heat of Lubricant	J/(Kg · °C), BTU/(lbf · °F)	F _c	Centrifugal Force	N, lbf
C _t	Basic Thrust Dynamic Load Rating	N, lbf	F _r	Applied Radial Load	N, lbf
d	Bearing Bore Diameter	mm, in.	F _{rh}	Resultant Horizontal Force	N, lbf
d	Ball Diameter	mm, in.	F _{RS}	Resultant Separating Force	N, lbf
d ₁	Spherical Diameter	mm, in.	F _{RV}	Resultant Vertical Force	N, lbf
d _a	Shaft Shoulder Diameter	mm, in.	F _S	Separating Force on Gear	N, lbf
d ₀	Mean Inner Ring Diameter	mm, in.	F _{SG}	Separating Force on Gear	N, lbf
dc	Distance Between Gear Centers	mm, in.	F _{SP}	Separating Force on Pinion	N, lbf
dm	Mean Bearing Diameter	mm, in.	F _{SW}	Separating Force on Worm	N, lbf
d _{si}	Shaft Inside Diameter	mm, in.	F _t	Tangential Force	N, lbf
D	Bearing Outside Diameter	mm, in.	F _{te}	Tractive Effort on Vehicle Wheels	N, lbf
D ₀	Tapered Roller Bearing Outer Ring Mean Raceway Diameter	mm, in.	F _{tG}	Tangential Force on Gear	N, lbf
D _h	Housing Outside Diameter	mm, in.	F _{tP}	Tangential Force on Pinion	N, lbf
D _m	Mean Diameter or Effective Working Diameter of a Sprocket, Pulley, Wheel or Tire	mm, in.	F _{tW}	Tangential Force on Worm	N, lbf
D _m	Tapered Roller Mean Large Rib Diameter	mm, in.	F _w	Force of Unbalance	N, lbf
			F _{WB}	Weighted Average Load	N, lbf
			G	Gear (used as subscript)	unitless
			G ₁	Geometry Factor from Bearing Data Tables	unitless
			G ₂	Geometry Factor from Bearing Data Tables	unitless
			H	Power	kW, hp
			H _s	Housing Shoulder Inner Diameter	mm, in.

DETERMINATION OF APPLIED LOADS AND BEARING ANALYSIS

Symbol	Description	Units (Metric/Inch System)	Symbol	Description	Units (Metric/Inch System)
HFS	Static Load Rating Adjustment Factor for Raceway Hardness	unitless	RIC	Radial Internal Clearance	mm, in.
i	Number of Rows of Rollers in a Bearing	unitless	S	Shaft Diameter	mm, in.
i _B	Number of Bearing Rows Taking Load	unitless	s	Shaft (used as subscript)	unitless
k	Centrifugal Force Constant	lbf/RPM ²	S _d	Inner Ring Reference Face Runout	mm, in.
k ₁	Bearing Torque Constant	unitless	S _D	Outside Cylindrical Surface Runout	mm, in.
k ₄ , k ₅ , k ₆	Dimensional Factor to Calculate Heat Generation	unitless	S _{ea}	Axial Runout of Outer Ring Assembly	mm, in.
K	Tapered Roller Bearing K-factor; ratio of basic dynamic radial load rating to basic dynamic thrust rating in a single-row bearing	unitless	S _{ia}	Axial Runout of Inner Ring Assembly	mm, in.
K	Ball Bearing Constant Based on Geometry		t ₁ , t ₂ , ..., t _n	Fractions of Time During a Loading Cycle	unitless
K ₁ , K ₂	Super Precision K-Factors	unitless	T	Applied Thrust (Axial) Load	N, lbf
K _{ea}	Radial Runout of Outer Ring Assembly	mm, in.	T _E	Equivalent Thrust Load	N, lbf
K _o	Outer Ring Contour Radius Expressed as a Decimal Fraction of the Ball Diameter	decimal fraction	v	Vertical (used as subscript)	unitless
K _i	Inner Ring Contour Radius Expressed as a Decimal Fraction of the Ball Diameter	decimal fraction	V	Linear Velocity or Speed	km/h, mph
K _{ia}	Radial Runout of Inner Ring Assembly	mm, in.	V _{BS}	Inner Ring Width Variation	mm, in.
K _N	K-factor for Bearing #n	unitless	V _{CS}	Outer Ring Width Variation	mm, in.
K _T	Relative Thrust Load Factor – Ball Bearings	unitless	V _r	Rubbing, Surface or Tapered Roller Bearing Rib Velocity	m/s, fpm
L _H	Lead – Axial Advance of a Helix for One Complete Revolution	mm, in.	W	Worm (used as subscript)	unitless
L	Distance Between Bearing Geometric Center Lines	mm, in.	X	Dynamic Radial Load Factor	unitless
L ₁₀	Bearing Life	revolutions or hours	X ₀	Static Radial Load Factor	unitless
L _f	Life Factor	unitless	Y, Y ₁ , Y ₂ , ...	Dynamic Thrust (Axial) Load Factor	unitless
m	Gearing Ratio	unitless	Y ₀	Static Thrust (Axial) Load Factor	unitless
M	Bearing Operating Torque	N-m, N-mm, lb.-in.	Z	Number of Rolling Elements	unitless
M ₀	Moment	N-m, N-mm, lb.-in.	α _T	Coefficient of Linear Expansion	mm/mm/°C, in./in./°F
n	Bearing Operating Speed or General Term for Speed	rot/min, RPM	α _o	Tapered Roller Bearing Half Included Outer Ring Raceway Angle	deg.
n ₁ , n ₂ , ..., n _n	Rotation Speeds During a Loading Cycle	rot/min, RPM	α	Ball Bearing Nominal Contact Angle	deg.
N _A	Reference Speed	rot/min, RPM	ΔT	Temperature Difference Between Shaft/Inner Ring/ Rollers and Housing/Outer Ring	°C, °F
n _G	Gear Operating Speed	rot/min, RPM	Δ _{BS}	Inner Ring Width Deviation	mm, in.
n _P	Pinion Operating Speed	rot/min, RPM	Δ _{CS}	Outer Ring Width Deviation	mm, in.
n _W	Worm Operating Speed	rot/min, RPM	Δ _{dmp}	Deviation of Mean Bore Diameter in a Single Plane	mm, in.
N _c	Number of Rotations of the Ball and Cage Assembly	unitless	Δ _{Dmp}	Deviation of Mean Outside Diameter in a Single Plane	mm, in.
N _i	Number of Rotations of the Inner Ring	unitless	δ _s	Interference Fit of Inner Ring on Shaft	mm, in.
N _G	Number of Teeth in the Gear	unitless	δ _h	Interference Fit of Outer Ring in Housing	mm, in.
N _P	Number of Teeth in the Pinion	unitless	η	Efficiency, Decimal Fraction	
N _S	Number of Teeth in the Sprocket	unitless	θ ₁ , θ ₂ , θ ₃	Gear Mesh Angles Relative to the Reference Plane	deg., rad
N _f	Speed Factor	unitless	θ _i , θ _o	Oil Inlet or Outlet Temperature	°C, °F
P	Pinion (used as subscript)	unitless	λ	Worm Gear Lead Angle	deg.
P _o	Static Equivalent Load	N, lbf	μ	Coefficient of Friction	unitless
P _{oa}	Static Equivalent Thrust (Axial)	N, lbf	μ	Lubricant Dynamic Viscosity	cP
P _{or}	Static Equivalent Radial Load	N, lbf	v	Lubricant Kinematic Viscosity	cSt
P _a	Dynamic Equivalent Axial Load	N, lbf	σ _o	Approximate Maximum Contact Stress	MPa, psi
P _r	Dynamic Equivalent Radial Load	N, lbf	Φ _G	Normal Tooth Pressure Angle for the Gear	deg.
P _{eq}	Equivalent Dynamic Load	N, lbf	Φ _P	Normal Tooth Pressure Angle for the Pinion	deg.
Q	Generated Heat or Heat Dissipation Rate	W, BTU/min	Ψ _G	Helix (Helical) or Spiral Angle for the Gear	deg.
Q _{gen}	Generated Heat	W, BTU/min	Ψ _P	Helix (Helical) or Spiral Angle for the Pinion	deg.
Q _{oil}	Heat Dissipated by a Circulating Oil System	W, BTU/min	ρ	Lubricant Density	kg/m ³ , lb./ft ³
r	Radius to Center of Mass	mm, in.	Υ _G	Bevel Gearing – Gear Pitch Angle	deg.
R	Percent Reliability, Used in the Calculation of the a ₁ Factor	unitless	Υ _P	Hypoid Gearing – Gear Root Angle	deg.
				Bevel Gearing – Pinion Pitch Angle	deg.
				Hypoid Gearing – Pinion Face Angle	deg.

METRIC SYSTEM TOLERANCES

Tapered bearings are manufactured to a number of specifications with each having classes that define tolerances on dimensions such as bore, O.D., width and runout. Metric bearings have been manufactured to corresponding standard negative tolerances.

Boundary dimension tolerances for tapered roller bearing usage are listed in the following tables. These tolerances are provided for use in selecting bearings for general applications in conjunction with the bearing mounting and fitting practices offered in later sections.

The following table summarizes the different specifications and classes for tapered roller bearings.

TABLE 1. BEARING SPECIFICATIONS AND CLASSES

System	Specification	Bearing Type	Standard Bearing Class		Precision Bearing Class			
Metric	Timken	Tapered Roller Bearings	K	N	C	B	A	AA
	ISO/DIN	All Bearing Types	P0	P6	P5	P4	P2	-
	ABMA	Tapered Roller Bearings	K	N	C	B	A	-
Inch	Timken	Tapered Roller Bearings	4	2	3	0	00	000
	ABMA	Tapered Roller Bearings	4	2	3	0	00	-

METRIC SYSTEM BEARINGS (ISO AND J PREFIX PARTS)

Timken manufactures metric system bearings to six tolerance classes. Classes K and N are often referred to as standard classes. Class N has more closely controlled width tolerances than K. Classes C, B, A and AA are precision classes. These

tolerances lie within those currently specified in ISO 492 with the exception of a small number of dimensions indicated in the tables. The differences normally have an insignificant effect on the mounting and performance of tapered roller bearings.

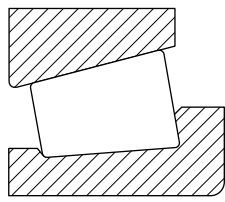


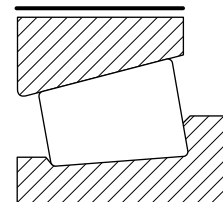
TABLE 2. TAPERED ROLLER BEARING TOLERANCES – INNER RING BORE (Metric)

Bearing Types	Bore		Standard Bearing Class				Precision Bearing Class							
			K		N		C		B		A		AA	
	Over	Incl.	Max.	Min.	Max.	Min.	Max.	Min.	Max.	Min.	Max.	Min.	Max.	Min.
	mm	mm	mm	mm	mm	mm	mm	mm	mm	mm	mm	mm	mm	mm
	in.	in.	in.	in.	in.	in.	in.	in.	in.	in.	in.	in.	in.	in.
TS TSF SR ⁽¹⁾	10.000	18.000	0.000	-0.012	0.000	-0.012	0.000	-0.007	0.000	-0.005	0.000	-0.005	0.000	-0.005
	0.3937	0.7087	0.0000	-0.00047	0.0000	-0.00047	0.0000	-0.0002	0.0000	-0.0001	0.0000	-0.0001	0.0000	-0.0001
	18.000	30.000	0.000	-0.012	0.000	-0.012	0.000	-0.008	0.000	-0.006	0.000	-0.006	0.000	-0.006
	0.7087	1.1811	0.0000	-0.0005	0.0000	-0.0005	0.0000	-0.0003	0.0000	-0.0002	0.0000	-0.0002	0.0000	-0.0002
	30.000	50.000	0.000	-0.012	0.000	-0.012	0.000	-0.010	0.000	-0.008	0.000	-0.008	0.000	-0.008
	1.1811	1.9685	0.0000	-0.0005	0.0000	-0.0005	0.0000	-0.0004	0.0000	-0.0003	0.0000	-0.0003	0.0000	-0.0003
	50.000	80.000	0.000	-0.015	0.000	-0.015	0.000	-0.012	0.000	-0.009	0.000	-0.008	0.000	-0.008
	1.9685	3.1496	0.0000	-0.0006	0.0000	-0.0006	0.0000	-0.0005	0.0000	-0.0004	0.0000	-0.0003	0.0000	-0.0003
	80.000	120.000	0.000	-0.020	0.000	-0.020	0.000	-0.015	0.000	-0.010	0.000	-0.008	0.000	-0.008
	3.1496	4.7244	0.0000	-0.00079	0.0000	-0.00079	0.0000	-0.0006	0.0000	-0.0004	0.0000	-0.0003	0.0000	-0.0003
	120.000	180.000	0.000	-0.025	0.000	-0.025	0.000	-0.018	0.000	-0.013	0.000	-0.008	0.000	-0.008
	4.7244	7.0886	0.0000	-0.00098	0.0000	-0.00098	0.0000	-0.0007	0.0000	-0.0005	0.0000	-0.0003	0.0000	-0.0003
	180.000	250.000	0.000	-0.030	0.000	-0.030	0.000	-0.022	0.000	-0.015	0.000	-0.008	0.000	-0.008
	7.0886	9.8425	0.0000	-0.0012	0.0000	-0.0012	0.0000	-0.0009	0.0000	-0.0006	0.0000	-0.0003	0.0000	-0.0003
	250.000	265.000	0.000	-0.035	0.000	-0.035	0.000	-0.022	0.000	-0.015	0.000	-0.008	0.000	-0.008
	9.8425	10.4331	0.0000	-0.0014	0.0000	-0.0014	0.0000	-0.0009	0.0000	-0.0006	0.0000	-0.0003	0.0000	-0.0003
	265.000	315.000	0.000	-0.035	0.000	-0.035	0.000	-0.022	0.000	-0.015	0.000	-0.008	0.000	-0.008
	10.4331	12.4016	0.0000	-0.0014	0.0000	-0.0014	0.0000	-0.0009	0.0000	-0.0006	0.0000	-0.0003	0.0000	-0.0003
	315.000	400.000	0.000	-0.040	0.000	-0.040	0.000	-0.025	-	-	-	-	-	-
	12.4016	15.7480	0.0000	-0.0016	0.0000	-0.0016	0.0000	-0.0010	-	-	-	-	-	-
400.000	500.000	0.000	-0.045	0.000	-0.045	0.000	-0.025	-	-	-	-	-	-	
15.7480	19.6850	0.0000	-0.0018	0.0000	-0.0018	0.0000	-0.0010	-	-	-	-	-	-	
500.000	630.000	0.000	-0.050	0.000	-0.050	0.000	-0.030	-	-	-	-	-	-	
19.6850	24.8031	0.0000	-0.0020	0.0000	-0.0020	0.0000	-0.0012	-	-	-	-	-	-	
630.000	800.000	0.000	-0.080	-	-	0.000	-0.040	-	-	-	-	-	-	
24.8031	31.4961	0.0000	-0.0031	-	-	0.0000	-0.0014	-	-	-	-	-	-	
800.000	1000.000	0.000	-0.100	-	-	0.000	-0.050	-	-	-	-	-	-	
31.4961	39.3701	0.0000	-0.0040	-	-	0.0000	-0.0020	-	-	-	-	-	-	
1000.000	1200.000	0.000	-0.130	-	-	0.000	-0.060	-	-	-	-	-	-	
39.3701	47.2441	0.0000	-0.0051	-	-	0.0000	-0.0024	-	-	-	-	-	-	
1200.000	1600.000	0.000	-0.150	-	-	0.000	-0.080	-	-	-	-	-	-	
47.2441	62.9921	0.0000	-0.0065	-	-	0.0000	-0.0031	-	-	-	-	-	-	
1600.000	2000.000	0.000	-0.200	-	-	-	-	-	-	-	-	-	-	
62.9921	78.7402	0.0000	-0.0079	-	-	-	-	-	-	-	-	-	-	
2000.000	-	0.000	-0.250	-	-	-	-	-	-	-	-	-	-	
78.7402	-	0.0000	-0.0098	-	-	-	-	-	-	-	-	-	-	

⁽¹⁾SR assemblies are manufactured to tolerance class N only.

TABLE 3. TAPERED ROLLER BEARING TOLERANCES – OUTER RING OUTSIDE DIAMETER (Metric)

Bearing Type	O.D.		Standard Bearing Class				Precision Bearing Class							
			K		N		C		B		A		AA	
	Over	Incl.	Max.	Min.	Max.	Min.	Max.	Min.	Max.	Min.	Max.	Min.	Max.	Min.
	mm	mm	mm	mm	mm	mm	mm	mm	mm	mm	mm	mm	mm	mm
	in.	in.	in.	in.	in.	in.	in.	in.	in.	in.	in.	in.	in.	in.
TS TSF SR ⁽¹⁾	10.000	18.000	0.000	-	-	-	-	-	-	-	0.000	-0.008	0.000	-0.008
	0.3937	0.7087	0.0000	-	-	-	-	-	-	-	0.0000	-0.0003	0.0000	-0.0003
	18.000	30.000	0.000	-0.012	0.000	-0.012	0.000	-0.008	0.000	-0.0006	0.000	-0.008	0.000	-0.008
	0.7087	1.1811	0.0000	-0.00047	0.0000	-0.00047	0.0000	-0.0003	0.0000	-0.0002	0.0000	-0.0003	0.0000	-0.0003
	30.000	50.000	0.000	-0.014	0.000	-0.014	0.000	-0.009	0.000	-0.007	0.000	-0.008	0.000	-0.008
	1.1811	1.9685	0.0000	-0.0005	0.0000	-0.0005	0.0000	-0.0004	0.0000	-0.0003	0.0000	-0.0003	0.0000	-0.0003
	50.000	80.000	0.000	-0.016	0.000	-0.016	0.000	-0.011	0.000	-0.009	0.000	-0.008	0.000	-0.008
	1.9685	3.1496	0.0000	-0.0006	0.0000	-0.0006	0.0000	-0.0004	0.0000	-0.0004	0.0000	-0.0003	0.0000	-0.0003
	80.000	120.000	0.000	-0.018	0.000	-0.018	0.000	-0.013	0.000	-0.010	0.000	-0.008	0.000	-0.008
	3.1496	4.7244	0.0000	-0.0007	0.0000	-0.0007	0.0000	-0.0005	0.0000	-0.0004	0.0000	-0.0003	0.0000	-0.0003
	120.000	150.000	0.000	-0.020	0.000	-0.020	0.000	-0.015	0.000	-0.011	0.000	-0.008	0.000	-0.008
	4.7244	5.9055	0.0000	-0.00079	0.0000	-0.00079	0.0000	-0.0006	0.0000	-0.0004	0.0000	-0.0003	0.0000	-0.0003
	150.000	180.000	0.000	-0.025	0.000	-0.025	0.000	-0.018	0.000	-0.013	0.000	-0.008	0.000	-0.008
	5.9055	7.0866	0.0000	-0.00098	0.0000	-0.00098	0.0000	-0.0007	0.0000	-0.0005	0.0000	-0.0003	0.0000	-0.0003
	180.000	250.000	0.000	-0.030	0.000	-0.030	0.000	-0.020	0.000	-0.015	0.000	-0.008	0.000	-0.008
	7.0866	9.8425	0.0000	-0.0012	0.0000	-0.0012	0.0000	-0.0008	0.0000	-0.0006	0.0000	-0.0003	0.0000	-0.0003
	250.000	265.000	0.000	-0.035	0.000	-0.035	0.000	-0.025	0.000	-0.018	0.000	-0.008	0.000	-0.008
	9.8425	10.4331	0.0000	-0.0014	0.0000	-0.0014	0.0000	-0.0010	0.0000	-0.0007	0.0000	-0.0003	0.0000	-0.0003
	265.000	315.000	0.000	-0.035	0.000	-0.035	0.000	-0.025	0.000	-0.018	0.000	-0.008	0.000	-0.008
	10.4331	12.4016	0.0000	-0.0014	0.0000	-0.0014	0.0000	-0.0010	0.0000	-0.0007	0.0000	-0.0003	0.0000	-0.0003
315.000	400.000	0.000	-0.040	0.000	-0.040	0.000	-0.028	0.000	-0.020	-	-	-	-	
12.4016	15.7480	0.0000	-0.0016	0.0000	-0.0016	0.0000	-0.0011	0.0000	-0.0008	-	-	-	-	
400.000	500.000	0.000	-0.045	0.000	-0.045	0.000	-0.030	-	-	-	-	-	-	
15.7480	19.6850	0.0000	-0.0018	0.0000	-0.0018	0.0000	-0.0012	-	-	-	-	-	-	
500.000	630.000	0.000	-0.050	0.000	-0.050	0.000	-0.035	-	-	-	-	-	-	
19.6850	24.8031	0.0000	-0.0020	0.0000	-0.0020	0.0000	-0.0014	-	-	-	-	-	-	
630.000	800.000	0.000	-0.075	-	-	0.000	-0.040	-	-	-	-	-	-	
24.8031	31.4961	0.0000	-0.0030	-	-	0.0000	*0.0016	-	-	-	-	-	-	
800.000	1000.000	0.000	-0.100	-	-	0.000	-0.050	-	-	-	-	-	-	
31.4961	39.3701	0.0000	-0.0040	-	-	0.0000	-0.0020	-	-	-	-	-	-	
1000.000	1200.000	0.000	-0.130	-	-	0.000	-0.060	-	-	-	-	-	-	
39.3701	47.2441	0.0000	-0.0051	-	-	0.0000	-0.0024	-	-	-	-	-	-	
1200.000	1600.000	0.000	-0.165	-	-	0.000	-0.080	-	-	-	-	-	-	
47.2441	62.9921	0.0000	-0.0065	-	-	0.0000	-0.0031	-	-	-	-	-	-	
1600.000	2000.000	0.000	-0.200	-	-	-	-	-	-	-	-	-	-	
62.9921	78.7402	0.0000	-0.0079	-	-	-	-	-	-	-	-	-	-	
2000.000	-	0.000	-0.250	-	-	-	-	-	-	-	-	-	-	
78.7402	-	0.0000	-0.0098	-	-	-	-	-	-	-	-	-	-	



⁽¹⁾SR assemblies are manufactured to tolerance class N only.

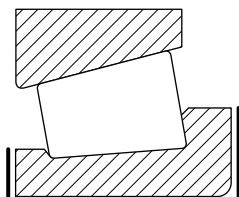
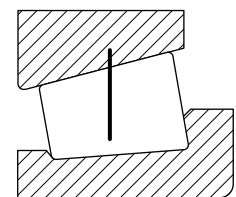


TABLE 4. TAPERED ROLLER BEARING TOLERANCES – INNER RING WIDTH (Metric)

Bearing Types	Bore		Standard Bearing Class				Precision Bearing Class							
			K		N		C		B		A		AA	
	Over	Incl.	Max.	Min.	Max.	Min.	Max.	Min.	Max.	Min.	Max.	Min.	Max.	Min.
	mm	mm	mm	mm	mm	mm	mm	mm	mm	mm	mm	mm	mm	mm
	in.	in.	in.	in.	in.	in.	in.	in.	in.	in.	in.	in.	in.	in.
TS TSF	10.000	50.000	0.000	-0.100	0.000	-0.050	0.000	-0.200	0.000	-0.200	0.000	-0.200	0.000	-0.200
	0.3937	1.9685	0.0000	-0.0040	0.0000	-0.0020	0.0000	-0.0079	0.0000	-0.0079	0.0000	-0.0079	0.0000	-0.0079
	50.000	120.000	0.000	-0.150	0.000	-0.050	0.000	-0.300	0.000	-0.300	0.000	-0.300	0.000	-0.300
	1.9685	4.7244	0.0000	-0.0059	0.0000	-0.0020	0.0000	-0.0118	0.0000	-0.0118	0.0000	-0.0118	0.0000	-0.0118
	120.000	180.000	0.000	-0.200	0.000	-0.050	0.000	-0.300	0.000	-0.300	0.000	-0.300	0.000	-0.300
	4.7244	7.0866	0.0000	-0.0079	0.0000	-0.0020	0.0000	-0.0118	0.0000	-0.0118	0.0000	-0.0118	0.0000	-0.0118
	180.000	250.000	0.000	-0.200	0.000	-0.050	0.000	-0.350	0.000	-0.350	0.000	-0.350	0.000	-0.350
	7.0866	9.8425	0.0000	-0.0079	0.0000	-0.0020	0.0000	-0.0138	0.0000	-0.0138	0.0000	-0.0138	0.0000	-0.0138
	250.000	265.000	0.000	-0.200	0.000	-0.050	0.000	-0.350	0.000	-0.350	0.000	-0.350	0.000	-0.350
	9.8425	10.4331	0.0000	-0.0079	0.0000	-0.0020	0.0000	-0.0138	0.0000	-0.0138	0.0000	-0.0138	0.0000	-0.0138
265.000	315.000	0.000	-0.200	0.000	-0.050	0.000	-0.350	0.000	-0.350	0.000	-0.350	0.000	-0.350	
10.4331	12.4016	0.0000	-0.0079	0.0000	-0.0020	0.0000	-0.0138	0.0000	-0.0138	0.0000	-0.0138	0.0000	-0.0138	
315.000	500.000	0.000	-0.250	0.000	-0.050	0.000	-0.350	-	-	-	-	-	-	
12.4016	19.6850	0.0000	-0.0098	0.0000	-0.0020	0.0000	-0.0138	-	-	-	-	-	-	
500.000	630.000	0.000	-0.250	0.000	-0.350	0.000	-0.350	-	-	-	-	-	-	
19.6850	24.8031	0.0000	-0.0098	0.0000	-0.0138	0.0000	-0.0138	-	-	-	-	-	-	
630.000	1200.000	0.000	-0.300	-	-	0.000	-0.350	-	-	-	-	-	-	
24.8031	47.2441	0.0000	-0.0118	-	-	0.0000	-0.0138	-	-	-	-	-	-	
1200.000	1600.000	0.000	-0.350	-	-	0.000	-0.350	-	-	-	-	-	-	
47.2441	62.9921	0.0000	-0.0138	-	-	0.0000	-0.0138	-	-	-	-	-	-	
1600.000	-	0.000	-0.350	-	-	-	-	-	-	-	-	-	-	
62.9921	-	0.0000	-0.0138	-	-	-	-	-	-	-	-	-	-	

TABLE 5. TAPERED ROLLER BEARING TOLERANCES – INNER RING STAND (Metric)

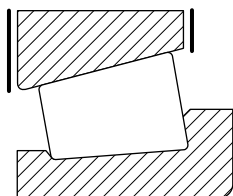
Bearing Types	Bore		Standard Bearing Class				Precision Bearing Class							
			K		N		C		B		A		AA	
	Over	Incl.	Max.	Min.	Max.	Min.	Max.	Min.	Max.	Min.	Max.	Min.	Max.	Min.
	mm	mm	mm	mm	mm	mm	mm	mm	mm	mm	mm	mm	mm	mm
	in.	in.	in.	in.	in.	in.	in.	in.	in.	in.	in.	in.	in.	in.
TS TSF	10.000	80.000	+0.100	0.000	+0.050	0.000	+0.100	-0.100						
	0.3937	3.1496	+0.0039	0.0000	+0.0020	0.0000	+0.0039	-0.0039						
	80.000	120.000	+0.100	-0.100	+0.050	0.000	+0.100	-0.100						
	3.1496	4.7244	+0.0039	-0.0039	+0.0020	0.0000	+0.0039	-0.0039						
	120.000	180.000	+0.150	-0.150	+0.050	0.000	+0.100	-0.100	(1)	(1)	(1)	(1)		
	4.7244	7.0866	+0.0059	-0.0059	+0.0020	0.0000	+0.0039	-0.0039						
	180.000	250.000	+0.150	-0.150	+0.050	0.000	+0.100	-0.150						
	7.0866	9.8425	+0.0059	-0.0059	+0.0020	0.0000	+0.0039	-0.0059						
250.000	265.000	+0.150	-0.150	+0.100	0.000	+0.100	-0.150							
9.8425	10.4331	+0.0059	-0.0059	+0.0039	0.0000	+0.0039	-0.0059							
265.000	315.000	+0.150	-0.150	+0.100	0.000	+0.100	-0.150			-	-	-	-	
10.4331	12.4016	+0.0059	-0.0059	+0.0039	0.0000	+0.0039	-0.0059							
315.000	400.000	+0.200	-0.200	+0.100	0.000	+0.150	-0.150			-	-	-	-	
12.4016	15.7480	+0.0079	-0.0079	+0.0039	0.0000	+0.0059	-0.0059							
400.000	-	(1)	(1)	(1)	(1)	(1)	(1)			-	-	-	-	
15.7480	-													



Inner Ring Stand. Inner Ring stand is a measure of the variation in Inner Ring raceway size, taper and roller diameter. This is checked by measuring the axial location of the reference surface of a master outer ring or other type gauge with respect to the reference Inner Ring face.

(1)These sizes manufactured as matched assemblies only.

TABLE 6. TAPERED ROLLER BEARING TOLERANCES – OUTER RING WIDTH (Metric)

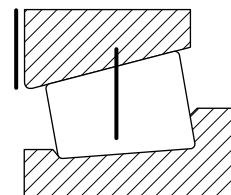


Bearing Types	O.D.		Standard Bearing Class				Precision Bearing Class							
			K		N		C		B		A		AA	
	Over	Incl.	Max.	Min. ⁽¹⁾	Max.	Min.	Max.	Min.	Max.	Min.	Max.	Min.	Max.	Min.
	mm	mm	mm	mm	mm	mm	mm	mm	mm	mm	mm	mm	mm	mm
	in.	in.	in.	in.	in.	in.	in.	in.	in.	in.	in.	in.	in.	in.
TS TSF	10.000	80.000	0.000	-0.150	0.000	-0.100	0.000	-0.150	0.000	-0.150	0.000	-0.150	0.000	-0.150
	0.3937	3.1496	0.0000	-0.0059	0.0000	-0.0040	0.0000	-0.0059	0.0000	-0.0059	0.0000	-0.0059	0.0000	-0.0059
	80.000	150.000	0.000	-0.200	0.000	-0.100	0.000	-0.200	0.000	-0.200	0.000	-0.200	0.000	-0.200
	3.1496	5.9055	0.0000	-0.0079	0.0000	-0.0040	0.0000	-0.0079	0.0000	-0.0079	0.0000	-0.0079	0.0000	-0.0079
	150.000	180.000	0.000	-0.200	0.000	-0.100	0.000	-0.250	0.000	-0.250	0.000	-0.250	0.000	-0.250
	5.9055	7.0866	0.0000	-0.0079	0.0000	-0.0040	0.0000	-0.0098	0.0000	-0.0098	0.0000	-0.0098	0.0000	-0.0098
	180.000	250.000	0.000	-0.250	0.000	-0.100	0.000	-0.250	0.000	-0.250	0.000	-0.250	0.000	-0.250
	7.0866	9.8425	0.0000	-0.0098	0.0000	-0.0040	0.0000	-0.0098	0.0000	-0.0098	0.0000	-0.0098	0.0000	-0.0098
	250.000	265.000	0.000	-0.250	0.000	-0.100	0.000	-0.300	0.000	-0.300	0.000	-0.300	0.000	-0.300
	9.8425	10.4331	0.0000	-0.0098	0.0000	-0.0040	0.0000	-0.0118	0.0000	-0.0118	0.0000	-0.0118	0.0000	-0.0118
	265.000	315.000	0.000	-0.250	0.000	-0.100	0.000	-0.300	0.000	-0.300	0.000	-0.300	0.000	-0.300
	10.4331	12.4016	0.0000	-0.0098	0.0000	-0.0040	0.0000	-0.0118	0.0000	-0.0118	0.0000	-0.0118	0.0000	-0.0118
315.000	400.000	0.000	-0.250	0.000	-0.100	0.000	-0.300	0.000	-0.300	-	-	-	-	
12.4016	15.7480	0.0000	-0.0098	0.0000	-0.0040	0.0000	-0.0118	0.0000	-0.0118	-	-	-	-	
400.000	500.000	0.000	-0.300	0.000	-0.100	0.000	-0.350	-	-	-	-	-	-	
15.7480	19.6850	0.0000	-0.0118	0.0000	-0.0040	0.0000	-0.0138	-	-	-	-	-	-	
500.000	800.000	0.000	-0.300	0.000	-0.100	0.000	-0.350	-	-	-	-	-	-	
19.6850	31.4961	0.0000	-0.0118	0.0000	-0.0040	0.0000	-0.0138	-	-	-	-	-	-	
800.000	1200.000	0.000	-0.350	-	-	0.000	-0.400	-	-	-	-	-	-	
31.4961	47.2441	0.0000	-0.0138	-	-	0.0000	-0.0157	-	-	-	-	-	-	
1200.000	1600.000	0.000	-0.400	-	-	0.000	-0.400	-	-	-	-	-	-	
47.2441	62.9921	0.0000	-0.0157	-	-	0.0000	-0.0157	-	-	-	-	-	-	
1600.000	-	0.000	-0.400	-	-	-	-	-	-	-	-	-	-	
62.9921	-	0.0000	-0.0157	-	-	-	-	-	-	-	-	-	-	

⁽¹⁾These differ slightly from tolerances in ISO 492. These differences normally have an insignificant effect on the mounting and performance of tapered roller bearings. The 30000 series ISO bearings also are available with the above parameter according to ISO 492.

TABLE 7. TAPERED ROLLER BEARING TOLERANCES – OUTER RING STAND (Metric)

Bearing Types	O.D.		Standard Bearing Class				Precision Bearing Class							
			K		N		C		B		A		AA	
	Over	Incl.	Max.	Min.	Max.	Min.	Max.	Min.	Max.	Min.	Max.	Min.	Max.	Min.
	mm	mm	mm	mm	mm	mm	mm	mm	mm	mm	mm	mm	mm	mm
	in.	in.	in.	in.	in.	in.	in.	in.	in.	in.	in.	in.	in.	in.
TS TSF ⁽¹⁾	10.000	18.000	+0.100	0.000	+0.050	0.000	+0.100	-0.100						
	0.3937	0.7087	+0.0039	0.0000	+0.0020	0.0000	+0.0039	-0.0039						
	18.000	80.000	+0.100	0.000	+0.050	0.000	+0.100	-0.100						
	0.7087	3.1496	+0.0039	0.0000	+0.0020	0.0000	+0.0039	-0.0039						
	80.000	120.000	+0.100	-0.100	+0.050	0.000	+0.100	-0.100	(2)	(2)	(2)	(2)		
	3.1496	4.7244	+0.0039	-0.0039	+0.0020	0.0000	+0.0039	-0.0039						
	120.000	265.000	+0.200	-0.100	+0.100	0.000	+0.100	-0.150						
	4.7244	10.4331	+0.0079	-0.0039	+0.0039	0.0000	+0.0039	-0.0059						
265.000	315.000	+0.200	-0.100	+0.100	0.000	+0.100	-0.150							
10.4331	12.4016	+0.0079	-0.0039	+0.0039	0.0000	+0.0039	-0.0059							
315.000	400.000	+0.200	-0.200	+0.100	0.000	+0.100	-0.150			-	-	-	-	
12.4016	15.7480	+0.0079	-0.0079	+0.0039	0.0000	+0.0039	-0.0059							
315.000	400.000	+0.200	-0.200	+0.100	0.000	+0.150	-0.150	-	-	-	-	-	-	
12.4016	15.7480	+0.0079	-0.0079	+0.0040	0.0000	+0.0059	-0.0059							
400.000	-	(2)	(2)	(2)	(2)	(2)	(2)	-	-	-	-	-	-	
15.7480	-													

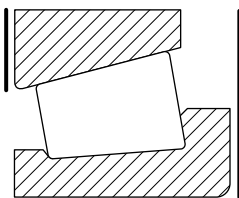


Outer Ring Stand. Outer ring stand is a measure of the variation in outer ring I.D. size and taper. This is checked by measuring the axial location of the reference surface of a master plug or other type gauge with respect to the reference face of the outer ring.

⁽¹⁾Stand for flanged outer ring is measured from flange backface (seating face).

⁽²⁾These sizes manufactured as matched assemblies only.

TABLE 8. TAPERED ROLLER BEARING TOLERANCES – OVERALL BEARING WIDTH (Metric)



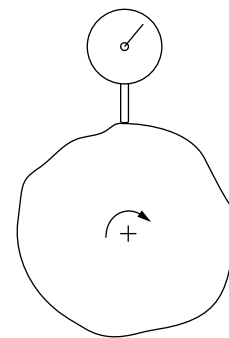
Bearing Types	Bore		Standard Bearing Class				Precision Bearing Class							
			K		N		C		B		A		AA	
	Over	Incl.	Max.	Min.	Max.	Min.	Max.	Min.	Max.	Min.	Max.	Min.	Max.	Min.
	mm	mm	mm	mm	mm	mm	mm	mm	mm	mm	mm	mm	mm	mm
	in.	in.	in.	in.	in.	in.	in.	in.	in.	in.	in.	in.	in.	in.
TS TSF ⁽¹⁾	10.000	80.000	+0.200	0.000	+0.100	0.000	+0.200	-0.200	+0.200	-0.200	+0.200	-0.200	+0.200	-0.200
	0.3937	3.1496	+0.0078	0.0000	+0.0039	0.0000	+0.0078	-0.0078	+0.0078	-0.0078	+0.0078	-0.0078	+0.0078	-0.0078
	80.000	120.000	+0.200	-0.200	+0.100	0.000	+0.200	-0.200	+0.200	-0.200	+0.200	-0.200	+0.200	-0.200
	3.1496	4.7244	+0.0078	-0.0078	+0.0039	0.0000	+0.0078	-0.0078	+0.0078	-0.0078	+0.0078	-0.0078	+0.0078	-0.0078
	120.000	180.000	+0.350	-0.250	+0.150	0.000	+0.350	-0.250	+0.200	-0.250	+0.200	-0.250	+0.200	-0.250
	4.7244	7.0866	+0.0137	-0.0098	+0.0059	0.0000	+0.0137	-0.0098	+0.0078	-0.0098	+0.0078	-0.0098	+0.0078	-0.0098
	180.000	250.000	+0.350	-0.250	+0.150	0.000	+0.350	-0.250	+0.200	-0.300	+0.200	-0.300	+0.200	-0.300
	7.0866	9.8425	+0.0137	-0.0098	+0.0059	0.0000	+0.0137	-0.0098	+0.0078	-0.0118	+0.0078	-0.0118	+0.0078	-0.0118
	250.000	265.000	+0.350	-0.250	+0.200	0.000	+0.350	-0.300	+0.200	-0.300	+0.200	-0.300	+0.200	-0.300
	9.8425	10.4331	+0.0137	-0.0098	+0.0078	0.0000	+0.0137	-0.0118	+0.0078	-0.0118	+0.0078	-0.0118	+0.0078	-0.0118
	265.000	315.000	+0.350	-0.250	+0.200	0.000	+0.350	-0.300	+0.200	-0.300	+0.200	-0.300	+0.200	-0.300
	10.4331	12.4016	+0.0137	-0.0098	+0.0078	0.0000	+0.0137	-0.0118	+0.0078	-0.0118	+0.0078	-0.0118	+0.0078	-0.0118
315.000	500.000	+0.400	-0.400	+0.200	0.000	+0.350	-0.300	-	-	-	-	-	-	
12.4016	19.6850	+0.0157	-0.0157	+0.0078	0.0000	+0.0137	-0.0118	-	-	-	-	-	-	
500.000	800.000	+0.400	-0.400	-	-	+0.350	-0.400	-	-	-	-	-	-	
19.6850	31.4961	+0.0157	-0.0157	-	-	+0.0137	-0.0157	-	-	-	-	-	-	
800.000	1000.000	+0.450	-0.450	-	-	+0.350	-0.400	-	-	-	-	-	-	
31.4961	39.3701	+0.0177	-0.0177	-	-	+0.0137	-0.0157	-	-	-	-	-	-	
1000.000	1200.000	+0.450	-0.450	-	-	+0.350	-0.450	-	-	-	-	-	-	
39.3701	47.2441	+0.0177	-0.0177	-	-	+0.0137	-0.0177	-	-	-	-	-	-	
1200.000	1600.000	+0.450	-0.450	-	-	+0.350	-0.500	-	-	-	-	-	-	
47.2441	62.9921	+0.0177	-0.0177	-	-	+0.0137	-0.0196	-	-	-	-	-	-	
1600.000		+0.450	-0.450	-	-	-	-	-	-	-	-	-	-	
62.9921		+0.0177	-0.0177	-	-	-	-	-	-	-	-	-	-	
SR ⁽²⁾	180.000	250.000	0.000	-0.200	0.000	-0.050	0.000	-0.350	0.000	-0.350	0.000	-0.350	0.000	-0.350
	7.0866	9.8425	0.0000	-0.0079	0.0000	-0.0020	0.0000	-0.0138	0.0000	-0.0138	0.0000	-0.0138	0.0000	-0.0138

⁽¹⁾For bearing type TSF, the tolerance applies to the dimension T₁. Refer to the TSF data in this catalog.

⁽²⁾SR assemblies are manufactured to tolerance class N only.

TABLE 9. TAPERED ROLLER BEARING TOLERANCES – RADIAL RUNOUT (Metric)

Bearing Types	O.D.		Standard Bearing Class		Precision Bearing Class			
	Over	Incl.	K	N	C	B	A	AA
	mm in.	mm in.	mm in.	mm in.	mm in.	mm in.	mm in.	mm in.
TS TSF SR ⁽¹⁾	10.000 0.3937	18.000 0.7087	– –	– –	– –	– –	0.002 0.00008	0.001 0.00004
	18.000 0.7087	30.000 1.1811	0.018 0.0007	0.018 0.0007	0.005 0.0002	0.003 0.0001	0.002 0.00008	0.001 0.00004
	30.000 1.1811	50.000 1.9685	0.020 0.0008	0.020 0.0008	0.006 0.0002	0.003 0.0001	0.002 0.00008	0.001 0.00004
	50.000 1.9685	80.000 3.1496	0.025 0.0010	0.025 0.0010	0.006 0.0002	0.004 0.0002	0.002 0.00008	0.001 0.00004
	80.000 3.1496	120.000 4.7244	0.035 0.0014	0.035 0.0014	0.006 0.0002	0.004 0.0002	0.002 0.00008	0.001 0.00004
	120.000 4.7244	150.000 5.9055	0.040 0.0016	0.040 0.0016	0.007 0.0003	0.004 0.0002	0.002 0.00008	0.001 0.00004
	150.000 5.9055	180.000 7.0866	0.045 0.0018	0.045 0.0018	0.008 0.0003	0.004 0.0002	0.002 0.00008	0.001 0.00004
	180.000 7.0866	250.000 9.8425	0.050 0.0020	0.050 0.0020	0.010 0.0004	0.005 0.0002	0.002 0.00008	0.001 0.00004
	250.000 9.8425	265.000 10.4331	0.060 0.0024	0.060 0.0024	0.011 0.0004	0.005 0.0002	0.002 0.00008	0.001 0.00004
	265.000 10.4331	315.000 12.4016	0.060 0.0024	0.060 0.0024	0.011 0.0004	0.005 0.0002	0.002 0.00008	0.001 0.00004
	315.000 12.4016	400.000 15.7480	0.070 0.0028	0.070 0.0028	0.013 0.0005	0.005 0.0002	– –	– –
	400.000 15.7480	500.000 19.6850	0.080 0.0031	0.080 0.0031	– –	– –	– –	– –
	500.000 19.6850	630.000 24.8031	0.100 0.0039	– –	– –	– –	– –	– –
	630.000 24.8031	800.000 31.4961	0.120 0.0047	– –	– –	– –	– –	– –
	800.000 31.4961	1000.000 39.3701	0.140 0.0055	– –	– –	– –	– –	– –
	1000.000 39.3701	1200.000 47.2441	0.160 0.0063	– –	– –	– –	– –	– –
	1200.000 47.2441	1600.000 62.9921	0.180 0.0071	– –	– –	– –	– –	– –
	1600.000 62.9921	2000.000 78.7402	0.200 0.0079	– –	– –	– –	– –	– –
	2000.000 78.7402	– –	0.200 0.0079	– –	– –	– –	– –	– –



Runout. Runout is a measure of rotational accuracy expressed by Total Indicator Reading (T.I.R.). Total displacement is measured by an instrument sensing against a moving surface, or moved with respect to a fixed surface. A radial runout measurement includes both roundness errors and the centering error of the surface that the instrument head senses against.

⁽¹⁾SR assemblies are manufactured to tolerance class N only.

INCH SYSTEM TOLERANCES

Inch system bearings are manufactured to a number of tolerance classes. Classes 4 and 2 are often referred to as standard classes. Classes 3, 0, 00 and 000 are precision classes. Inch system bearings conform to ABMA standard 19.2.

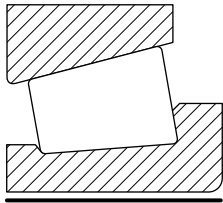


TABLE 10. TAPERED ROLLER BEARING TOLERANCES – INNER RING BORE (Inch)

Bearing Types	Bore		Standard Bearing Class				Precision Bearing Class							
			4		2		3		0		00		000	
	Over	Incl.	Max.	Min.	Max.	Min.	Max.	Min.	Max.	Min.	Max.	Min.	Max.	Min.
	mm	mm	mm	mm	mm	mm	mm	mm	mm	mm	mm	mm	mm	mm
	in.	in.	in.	in.	in.	in.	in.	in.	in.	in.	in.	in.	in.	in.
TS TSF TSL ⁽¹⁾ TDI TDIT TDO TNA	0.000	76.200	+0.013	0.000	+0.013	0.000	+0.013	0.000	+0.013	0.000	+0.008	0.000	+0.008	0.000
	0.0000	3.0000	+0.0005	0.0000	+0.0005	0.0000	+0.0005	0.0000	+0.0005	0.0000	+0.0003	0.0000	+0.0003	0.0000
	76.200	304.800	+0.025	0.000	+0.025	0.000	+0.013	0.000	+0.013	0.000	+0.008	0.000	+0.008	0.000
	3.0000	12.0000	+0.0010	0.0000	+0.0010	0.0000	+0.0005	0.0000	+0.0005	0.0000	+0.0003	0.0000	+0.0003	0.0000
	304.800	609.600	–	–	+0.051	0.000	+0.025	0.000	–	–	–	–	–	–
	12.0000	24.0000	–	–	+0.0020	0.0000	+0.0010	0.0000	–	–	–	–	–	–
609.600	914.400	+0.076	0.000	–	–	+0.038	0.000	–	–	–	–	–	–	
24.0000	36.0000	+0.0030	0.0000	–	–	+0.0015	0.0000	–	–	–	–	–	–	
914.400	1219.200	+0.102	0.000	–	–	+0.051	0.000	–	–	–	–	–	–	
36.0000	48.0000	+0.0040	0.0000	–	–	+0.0020	0.0000	–	–	–	–	–	–	
1219.200	–	+0.127	0.000	–	–	+0.076	0.000	–	–	–	–	–	–	
48.0000	–	+0.0050	0.0000	–	–	+0.0030	0.0000	–	–	–	–	–	–	

⁽¹⁾For TSL bearings these are the normal tolerances of inner ring bore. However, bore size can be slightly reduced at large end due to tight fit assembly of the seal on the rib. This should not have any effect on the performance of the bearing.

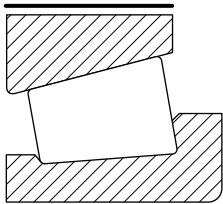


TABLE 11. TAPERED ROLLER BEARING TOLERANCES – OUTER RING OUTSIDE DIAMETER (Inch)

Bearing Types	O.D.		Standard Bearing Class				Precision Bearing Class							
			4		2		3		0		00		000	
	Over	Incl.	Max.	Min.	Max.	Min.	Max.	Min.	Max.	Min.	Max.	Min.	Max.	Min.
	mm	mm	mm	mm	mm	mm	mm	mm	mm	mm	mm	mm	mm	mm
	in.	in.	in.	in.	in.	in.	in.	in.	in.	in.	in.	in.	in.	in.
TS TSF TSL TDI TDIT TDO TNA TNASW TNASWE	0.000	304.800	+0.025	0.000	+0.025	0.000	+0.013	0.000	+0.013	0.000	+0.008	0.000	+0.008	0.000
	0.0000	12.0000	+0.0010	0.0000	+0.0010	0.0000	+0.0005	0.0000	+0.0005	0.0000	+0.0003	0.0000	+0.0003	0.0000
	304.800	609.600	+0.051	0.000	+0.051	0.000	+0.025	0.000	+0.013	0.000	+0.008	0.000	+0.008	0.000
	12.0000	24.0000	+0.0020	0.0000	+0.0020	0.0000	+0.0010	0.0000	+0.0005	0.0000	+0.0003	0.0000	+0.0003	0.0000
	609.600	914.400	+0.076	0.000	+0.076	0.000	+0.038	0.000	–	–	–	–	–	–
	24.0000	36.0000	+0.0030	0.0000	+0.0030	0.0000	+0.0015	0.0000	–	–	–	–	–	–
914.400	1219.200	+0.102	0.000	–	–	+0.051	0.000	–	–	–	–	–	–	
36.0000	48.0000	+0.0040	0.0000	–	–	+0.0020	0.0000	–	–	–	–	–	–	
1219.200	–	+0.127	0.000	–	–	+0.076	0.000	–	–	–	–	–	–	
48.0000	–	+0.0050	0.0000	–	–	+0.0030	0.0000	–	–	–	–	–	–	

TABLE 12. TAPERED ROLLER BEARING TOLERANCES – OUTER RING FLANGE (Inch)

Bearing Types	O.D.		Standard Bearing Class				Precision Bearing Class							
			4		2		3		0		00		000	
	Over	Incl.	Max.	Min.	Max.	Min.	Max.	Min.	Max.	Min.	Max.	Min.	Max.	Min.
	mm	mm	mm	mm	mm	mm	mm	mm	mm	mm	mm	mm	mm	mm
	in.	in.	in.	in.	in.	in.	in.	in.	in.	in.	in.	in.	in.	in.
TSF	0.000	304.800	+0.051	0.000	+0.052	0.000	+0.051	0.000	+0.051	0.000	+0.051	0.000	+0.051	0.000
	0.0000	12.0000	+0.0020	0.0000	+0.0020	0.0000	+0.0020	0.0000	+0.0020	0.0000	+0.0020	0.0000	+0.0020	0.0000
	304.800	609.600	+0.076	0.000	+0.076	0.000	+0.076	0.000	+0.051	0.000	+0.051	0.000	+0.051	0.000
	12.0000	24.0000	+0.0030	0.0000	+0.0030	0.0000	+0.0030	0.0000	+0.0020	0.0000	+0.0020	0.0000	+0.0020	0.0000
	609.600	914.400	+0.102	0.000	+0.102	0.000	+0.102	0.000	-	-	-	-	-	-
	24.0000	36.0000	+0.0040	0.0000	+0.0040	0.0000	+0.0040	0.0000	-	-	-	-	-	-
	914.400	-	+0.127	0.000	-	-	+0.127	0.000	-	-	-	-	-	-
	36.0000	-	+0.0050	0.0000	-	-	+0.0050	0.0000	-	-	-	-	-	-

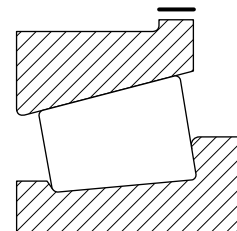


TABLE 13. TAPERED ROLLER BEARING TOLERANCES – INNER RING WIDTH (Inch)

Bearing Types	Bore		Standard Bearing Class				Precision Bearing Class							
			4		2		3		0		00		000	
	Over	Incl.	Max.	Min.	Max.	Min.	Max.	Min.	Max.	Min.	Max.	Min.	Max.	Min.
	mm	mm	mm	mm	mm	mm	mm	mm	mm	mm	mm	mm	mm	mm
	in.	in.	in.	in.	in.	in.	in.	in.	in.	in.	in.	in.	in.	in.
TS	All Sizes		+0.076	-0.254	+0.076	-0.254	+0.076	-0.254	+0.076	-0.254	+0.076	-0.254	+0.076	-0.254
TSF			+0.0030	-0.0100	+0.0030	-0.0100	+0.0030	-0.0100	+0.0030	-0.0100	+0.0030	-0.0100	+0.0030	-0.0100
TSL														
2S														
TDI														
TDIT														
TDO														

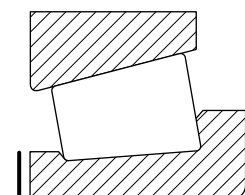
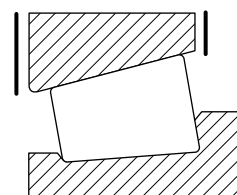
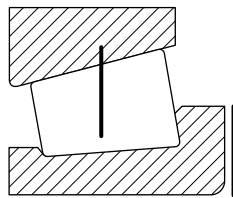


TABLE 14. TAPERED ROLLER BEARING TOLERANCES – OUTER RING WIDTH (Inch)

Bearing Types	O.D.		Standard Bearing Class				Precision Bearing Class							
			4		2		3		0		00		000	
	Over	Incl.	Max.	Min.	Max.	Min.	Max.	Min.	Max.	Min.	Max.	Min.	Max.	Min.
	mm	mm	mm	mm	mm	mm	mm	mm	mm	mm	mm	mm	mm	mm
	in.	in.	in.	in.	in.	in.	in.	in.	in.	in.	in.	in.	in.	in.
All Types	All Sizes		+0.051	-0.254	+0.051	-0.254	+0.051	-0.254	+0.051	-0.254	+0.051	-0.254	+0.051	-0.254
			+0.0020	-0.0100	+0.0020	-0.0100	+0.0020	-0.0100	+0.0020	-0.0100	+0.0020	-0.0100	+0.0020	-0.0100





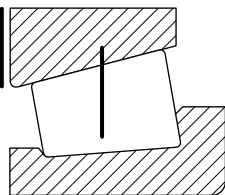
Inner Ring Stand. Inner Ring stand is a measure of the variation in Inner Ring raceway size, taper and roller diameter. This is checked by measuring the axial location of the reference surface of a master outer ring or other type gauge with respect to the reference Inner Ring face.

TABLE 15. TAPERED ROLLER BEARING TOLERANCES – INNER RING STAND (Inch)

Bearing Types	Bore		Standard Bearing Class				Precision Bearing Class							
	Over	Incl.	4		2		3		0		00		000	
	mm	mm	mm	mm	mm	mm	mm	mm	mm	mm	mm	mm	mm	mm
	in.	in.	in.	in.	in.	in.	in.	in.	in.	in.	in.	in.	in.	in.
TS TSF TSL 2S TDI ⁽¹⁾ TDIT ⁽¹⁾ TDO	0.000	101.600	+0.102	0.000	+0.102	0.000	+0.102	-0.102						
	0.0000	4.0000	+0.0040	0.0000	+0.0040	0.0000	+0.0040	-0.0040			(2)	(2)	(2)	(2)
	101.600	266.700	+0.152	-0.152	+0.102	0.000	+0.102	+0.102	(2)	(2)				
	4.0000	10.5000	+0.0060	-0.0060	+0.0040	0.0000	+0.0040	-0.0040						
	266.700	304.800	+0.152	-0.152	+0.102	0.000	+0.102	-0.102			-	-	-	-
	10.5000	12.0000	+0.0060	-0.0060	+0.0040	0.0000	+0.0040	-0.0040			-	-	-	-
	304.800	406.400	-	-	+0.178	-0.178	+0.178	-0.178	-	-	-	-	-	-
	12.0000	16.0000	-	-	+0.0070	-0.0070	+0.0070	-0.0070	-	-	-	-	-	-
	406.400	-	(2)	(2)	(2)	(2)	(2)	(2)	-	-	-	-	-	-
	16.0000	-							-	-	-	-	-	-

⁽¹⁾For class 2, TDI and TDIT bearings with an inner ring bore of 101.600 to 304.800 mm (4.0000 to 12.0000 in.), the inner ring stand is ± 0.102 mm (± 0.0040 in.).

⁽²⁾These sizes manufactured as matched assemblies only.



Outer Ring Stand. Outer ring stand is a measure of the variation in outer ring I.D. size and taper. This is checked by measuring the axial location of the reference surface of a master plug or other type gauge with respect to the reference face of the outer ring.

TABLE 16. TAPERED ROLLER BEARING TOLERANCES – OUTER RING STAND (Inch)

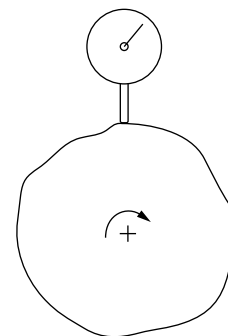
Bearing Types	Bore		Standard Bearing Class				Precision Bearing Class							
	Over	Incl.	4		2		3		0		00		000	
	mm	mm	mm	mm	mm	mm	mm	mm	mm	mm	mm	mm	mm	mm
	in.	in.	in.	in.	in.	in.	in.	in.	in.	in.	in.	in.	in.	in.
TS TSF ⁽¹⁾ TSL TDI TDIT	0.000	101.600	+0.102	0.000	+0.102	0.000	+0.102	-0.102						
	0.0000	4.0000	+0.0040	0.0000	+0.0040	0.0000	+0.0040	-0.0040			(2)	(2)	(2)	(2)
	101.600	266.700	+0.203	-0.102	+0.102	0.000	+0.102	-0.102	(2)	(2)				
	4.0000	10.5000	+0.0080	-0.0040	+0.0040	0.0000	+0.0040	-0.0040			-	-	-	-
	266.700	304.800	+0.203	-0.102	+0.102	0.000	+0.102	-0.102			-	-	-	-
	10.5000	12.0000	+0.0080	-0.0040	+0.0040	0.0000	+0.0040	-0.0040			-	-	-	-
	304.800	406.400	+0.203	-0.203	+0.203	-0.203	+0.203	-0.203	-	-	-	-	-	-
	12.0000	16.0000	+0.0080	-0.0080	+0.0080	-0.0080	+0.0080	-0.0080	-	-	-	-	-	-
	406.400	-	(2)	(2)	(2)	(2)	(2)	(2)	-	-	-	-	-	-
	16.0000	-							-	-	-	-	-	-

⁽¹⁾Stand for flanged outer ring is measured from flange backface (seating face).

⁽²⁾These sizes manufactured as matched assemblies only.

TABLE 17. TAPERED ROLLER BEARING TOLERANCES – RADIAL RUNOUT (Inch)

Bearing Types	O.D.		Standard Bearing Class		Precision Bearing Class			
	Over	Incl.	4	2	3	0	00	000
	mm in.	mm in.	mm in.	mm in.	mm in.	mm in.	mm in.	mm in.
TS	0.000 0.0000	266.700 10.5000	0.051 0.0020	0.038 0.0015	0.008 0.0003	0.004 0.00015	0.002 0.000075	0.001 0.000040
TSF	266.700	304.800	0.051	0.038	0.008	0.004	0.002	0.001
TSL	10.5000	12.0000	0.0020	0.0015	0.0003	0.00015	0.000075	0.000040
2S								
TDI	304.800	609.600	0.051	0.038	0.018	–	–	–
TDIT	12.0000	24.0000	0.0020	0.0015	0.0007	–	–	–
TDO								
TNA	609.600	914.400	0.076	0.051	0.051	–	–	–
TNASW	24.0000	36.0000	0.0030	0.0020	0.0020	–	–	–
TNASWE	914.400	–	0.076	–	0.076	–	–	–
	36.0000	–	0.0030	–	0.0030	–	–	–



Runout. Runout is a measure of rotational accuracy expressed by Total Indicator Reading (T.I.R.). Total displacement is measured by an instrument sensing against a moving surface, or moved with respect to a fixed surface. A radial runout measurement includes both roundness errors and the centering error of the surface that the instrument head senses against.

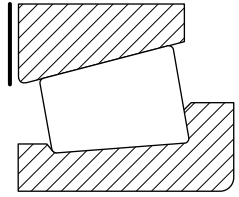


TABLE 18. TAPERED ROLLER BEARING TOLERANCES – OVERALL BEARING WIDTH (Inch)

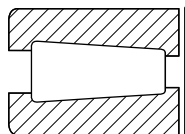
Bearing Types	Bore		O.D.		Standard Bearing Class				Precision Bearing Class								
	Over	Incl.	Over	Incl.	4		2		3		0		00		000		
					Max.	Min.	Max.	Min.	Max.	Min.	Max.	Min.	Max.	Min.	Max.	Min.	
	mm in.	mm in.	mm in.	mm in.	mm in.	mm in.	mm in.	mm in.	mm in.	mm in.	mm in.	mm in.	mm in.	mm in.	mm in.	mm in.	
TS TSF ⁽¹⁾ TSL	0.000 0.0000	101.600 4.0000	–	–	+0.203 +0.0080	0.000 0.0000	+0.203 +0.0080	0.000 0.0000	+0.203 +0.0080	-0.203 -0.0080	+0.203 +0.0080	-0.203 -0.0080	+0.203 +0.0080	-0.203 -0.0080	+0.203 +0.0080	-0.203 -0.0080	
	101.600 4.0000	304.800 12.0000	–	–	+0.356 +0.0140	-0.254 -0.0100	+0.203 +0.0080	0.000 0.0000	+0.203 +0.0080	-0.203 -0.0080	+0.203 +0.0080	-0.203 -0.0080	+0.203 +0.0080	-0.203 -0.0080	+0.203 +0.0080	-0.203 -0.0080	
	304.800 12.0000	609.600 24.0000	0.000 0.0000	508.000 20.0000	–	–	+0.381 +0.0150	-0.381 -0.0150	+0.203 +0.0080	-0.203 -0.0080	–	–	–	–	–	–	–
	304.800 12.0000	609.600 24.0000	508.000 20.0000	–	–	–	–	+0.381 +0.0150	-0.381 -0.0150	+0.381 +0.0150	-0.381 -0.0150	–	–	–	–	–	–
	609.600 24.0000	–	–	–	–	–	+0.381 +0.0150	-0.381 -0.0150	–	–	+0.381 +0.0150	-0.381 -0.0150	–	–	–	–	–
TNA TNASW TNASWE	0.000 0.0000	127.000 5.0000	–	–	–	–	+0.254 +0.0100	0.000 0.0000	+0.254 +0.0100	0.000 0.0000	–	–	–	–	–	–	
	127.000 5.0000	–	–	–	–	–	+0.762 +0.0300	0.000 0.0000	+0.762 +0.0300	0.000 0.0000	–	–	–	–	–	–	
TDI TDIT TDO	0.000 0.0000	101.600 4.0000	–	–	+0.406 +0.0160	0.000 0.0000	+0.406 +0.0160	0.000 0.0000	+0.406 +0.0160	-0.406 -0.0160	+0.406 +0.0160	-0.406 -0.0160	+0.406 +0.0160	-0.406 -0.0160	+0.406 +0.0160	-0.406 -0.0160	
	101.600 4.0000	304.800 12.0000	–	–	+0.711 +0.0280	-0.508 -0.0200	+0.406 +0.0160	-0.203 -0.0080	+0.406 +0.0160	-0.406 -0.0160	+0.406 +0.0160	-0.406 -0.0160	+0.406 +0.0160	-0.406 -0.0160	+0.406 +0.0160	-0.406 -0.0160	
	304.800 12.0000	609.600 24.0000	0.000 0.0000	508.000 20.0000	–	–	+0.762 +0.0300	-0.762 -0.0300	+0.406 +0.0160	-0.406 -0.0160	–	–	–	–	–	–	
	304.800 12.0000	609.600 24.0000	508.000 20.0000	–	–	–	+0.762 +0.0300	-0.762 -0.0300	+0.762 +0.0300	-0.762 -0.0300	–	–	–	–	–	–	
	609.600 24.0000	–	–	–	–	–	+0.762 +0.0300	-0.762 -0.0300	–	–	+0.762 +0.0300	-0.762 -0.0300	–	–	–	–	
2S	0.000 0.0000	101.600 4.0000	–	–	+0.457 +0.0180	-0.051 -0.0020	+0.457 +0.0180	-0.051 -0.0020	–	–	–	–	–	–	–	–	

⁽¹⁾For bearing type TSF, the tolerance applies to the dimension T₁. Refer to the TSF data tables in this catalog.

TABLE 19. THRUST TAPERED ROLLER BEARING TOLERANCES – BORE (Inch)

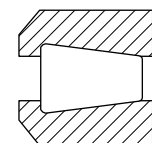
TTHD, TTHDFL, TTVS

TTC, TTSP – CLASS 4



TTHD, TTHDFL, TTVS

Bore		Bearing Class			
Range		Precision 2		Precision 3	
Over	Incl.	Over	Incl.	Max.	Min.
mm in.	mm in.	mm in.	mm in.	mm in.	mm in.
0.000 0.0000	304.800 12.0000	+0.025 +0.0010	0.000 0.0000	+0.013 +0.0005	0.000 0.0000
304.800 12.0000	609.600 24.0000	+0.051 0.0020	0.000 0.0000	+0.025 +0.0010	0.000 0.0000
609.600 24.0000	914.400 36.0000	+0.076 +0.0030	0.000 0.0000	+0.038 +0.0015	0.000 0.0000
914.400 36.0000	1219.200 48.0000	+0.102 +0.0040	0.000 0.0000	+0.051 0.0020	0.000 0.0000
1219.200 48.0000	–	+0.127 +0.0050	0.000 0.0000	+0.076 +0.030	0.000 0.0000



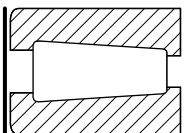
TTC, TTSP

Bore		Deviation	
Range		Precision 4	
Over	Incl.	Over	Incl.
mm in.	mm in.	mm in.	mm in.
0.000 0.0000	25.400 1.0000	+0.076 +0.0030	-0.076 -0.0030
25.400 1.0000	76.200 3.0000	+0.102 +0.0040	-0.102 -0.0040
76.200 3.0000	–	+0.127 +0.0050	-0.127 -0.0050

TABLE 20. THRUST TAPERED ROLLER BEARING TOLERANCES – OUTSIDE DIAMETER (Inch)

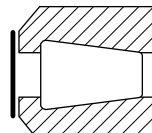
TTHD, TTHDFL, TTVS

TTC, TTSP – CLASS 4



TTHD, TTHDFL, TTVS

Outside Diameter		Bearing Class			
Range		Precision 2		Precision 3	
Over	Incl.	Over	Incl.	Max.	Min.
mm in.	mm in.	mm in.	mm in.	mm in.	mm in.
0.000 0.0000	304.800 12.0000	+0.025 +0.0010	0.000 0.0000	+0.013 +0.0005	0.000 0.0000
304.800 12.0000	609.600 24.0000	+0.051 0.0020	0.000 0.0000	+0.025 +0.0010	0.000 0.0000
609.600 24.0000	914.400 36.0000	+0.076 +0.0030	0.000 0.0000	+0.038 +0.0015	0.000 0.0000



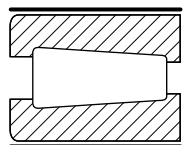
TTC, TTSP

Outside Diameter		Deviation	
Range		Precision 4	
Over	Incl.	Over	Incl.
mm in.	mm in.	mm in.	mm in.
0.000 0.0000	127.000 5.0000	+0.254 +0.0100	0.000 0.0000
127.000 5.0000	203.200 8.0000	+0.381 +0.0150	0.000 0.0000
203.200 8.0000	–	+0.508 +0.200	0.000 0.0000

TABLE 21. THRUST TAPERED ROLLER BEARING TOLERANCES – WIDTH (Inch)

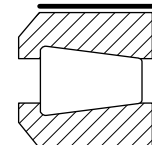
TTHD, TTHDFL, TTVS

TTC, TTSP – CLASS 4



TTHDFL

Width		Bearing Class			
Range		Precision 2		Precision 3	
Over	Incl.	Over	Incl.	Max.	Min.
mm in.	mm in.	mm in.	mm in.	mm in.	mm in.
All Sizes		+0.381 +0.0150	-0.381 -0.0150	+0.203 +0.0080	-0.203 -0.0080



TTC, TTSP

Width		Deviation	
Range		Precision 4	
Over	Incl.	Over	Incl.
mm in.	mm in.	mm in.	mm in.
0.000 0.0000	76.200 3.0000	+0.254 +0.0100	-0.254 -0.0100
76.200 3.0000	127.000 5.0000	+0.381 +0.0150	-0.381 -0.0150
127.000 5.0000	–	+0.508 +0.200	-0.508 -0.0200

TAPERED ROLLER BEARING MOUNTING, FITTING AND SETTING

MOUNTING

Tapered roller bearings are designed to take both radial and thrust loading. Under radial loads, a force is generated in the axial direction that must be counteracted. As a result, tapered roller bearings are normally adjusted against a second bearing. They can be mounted in either a direct or indirect mounting arrangement shown in fig. 9. For applications where a direct mounting arrangement is used and the outer ring is used to adjust the bearing setting, the outer ring is usually set in position by an outer-ring follower or mounted in an outer-ring carrier. See fig. 10.

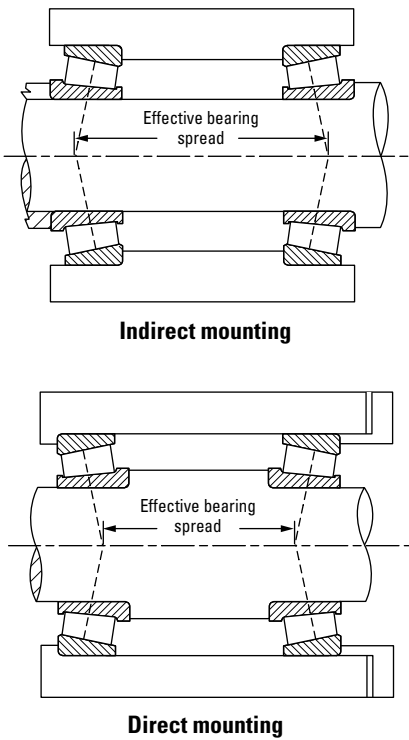


Fig. 9. Comparison of mounting stability between indirect and direct mountings.

For indirect mountings, bearing setting is typically achieved by clamping against one of the inner rings. Various designs, including locknuts, stakenuts and end plates as shown in fig. 11 can be used. For applications requiring precision-class bearings, a special precision nut can be used.

Backing shoulder diameters are listed for tapered roller bearings in the product data sections in this catalog.

FITTING PRACTICE

General industrial application fitting practice standards for inner rings and outer rings are shown in the tables starting on page 38. These tables apply to solid or heavy-sectioned steel shafts, heavy-sectioned ferrous housings and normal operating conditions. To use the tables, it is necessary to determine if the member is rotating or stationary, the magnitude, direction and type of loading, and the shaft finish.

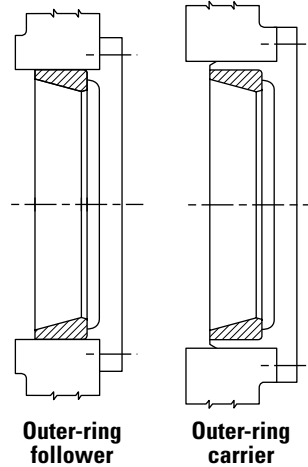


Fig. 10. Bearing setting devices - direct mounting.

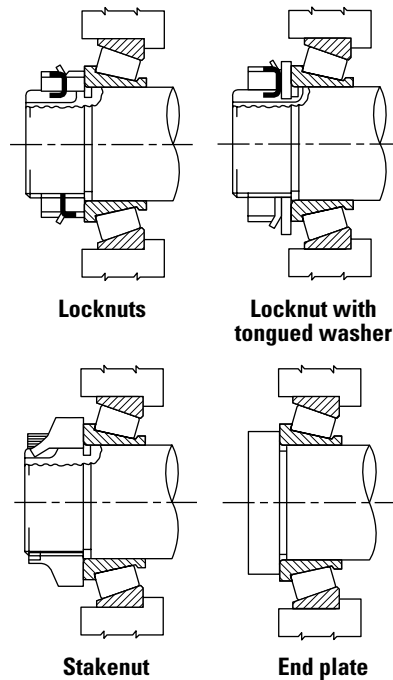


Fig. 11. Bearing setting devices – indirect mounting.

Certain table fits may not be adequate for light shaft and housing sections, shafts other than steel, nonferrous housings, critical operation conditions such as high speed, unusual thermal or loading conditions or a combination thereof. Also, assembly procedures and the means and ease of obtaining the bearing setting may require special fits. In these cases, experience should be used as a guideline or your Timken engineer should be consulted for review and suggestions.

Rotating inner rings generally should be applied with an interference fit. In special cases, loose fits may be considered if it has been determined by test or experience they will perform satisfactorily. The term "rotating inner ring" describes a condition in which the inner ring rotates relative to the load. This may occur with a rotating inner ring under a stationary load or a stationary inner ring with a rotating load. Loose fits will permit the inner rings to creep and wear the shaft and the backing shoulder. This may result in excessive bearing looseness and possible bearing and shaft damage.

Stationary inner ring fitting practice depends on the application. Under conditions of high speed, heavy loads or shock, interference fits using heavy-duty fitting practices should be used. With inner rings mounted on unground shafts subjected to moderate loads (no shock) and moderate speeds, a metal-to-metal or near zero average fit is used. In sheave and wheel applications using unground shafts, or in cases using ground shafts with moderate loads (no shock), a minimum fit near zero to a maximum looseness that varies with the inner ring bore size is suggested. In stationary inner ring applications requiring hardened and ground spindles, a slightly looser fit may be satisfactory. Special fits also may be necessary on installations such as multiple sheave crane blocks.

Rotating outer ring applications where the outer ring rotates relative to the load should always use an interference fit.

Stationary, non-adjustable and fixed single-row outer ring applications should be applied with a tight fit wherever practical. Generally, adjustable fits may be used where the bearing setup is obtained by sliding the outer ring axially in the housing bore. However, in certain heavy-duty, high-load applications, tight fits are necessary to prevent pounding and plastic deformation of the housing. Tightly fitted outer rings mounted in carriers can be used. Tight fits should always be used when the load rotates relative to the outer ring.

To permit through-boring when the outside diameters of single-row bearings mounted at each end of a shaft are equal, and one is adjustable and the other fixed, it is suggested that the same adjustable fit be used at both ends. However, tight fits should be used if outer rings are backed against snap rings to prevent excessive dishing of snap rings, groove wear and possible loss of ring retention. Only outer rings with a maximum housing fillet radius requirement of 1.3 mm (0.05 in.) or less should be considered for a snap ring backing.

Double-row stationary double outer rings are generally mounted with loose fits to permit assembly and disassembly. The loose fit also permits float when a floating bearing is mounted in conjunction with an axially fixed bearing on the other end of the shaft.

Fitting practice tables 22-32 on pages 38-52, have been prepared for both metric and inch dimensions.

For the inch system bearings, classes 4 and 2 (standard) have been included.

The metric system bearings that have been included are: classes K and N (metric system standard bearings).

Effects of tight fits on bearing setting/width

Interference fits of the inner ring cause inner ring expansion and interference fits of the outer ring cause outer ring contraction. As the inner ring diameters increase and the outer ring diameters decrease, internal clearance within the bearing is reduced and bearing width is increased. The change in clearance or setting is approximately equal to the change in width.

For matched assemblies where the setting is pre-set from the factory and SET-RIGHT assemblies, the effects of fit must be taken into account to provide the desired mounted setting.

Double-row and four-row bearings that are provided with spacers are examples of matched assemblies. These bearings are pre-set to a specific bench endplay or axial clearance prior to installation into the application. Mounting the bearing with a tight fit will reduce this bench endplay. In order to meet the desired mounted setting, the bench endplay must be compensated for the fit effect.

SET-RIGHT assemblies rely on the control of bearing, shaft and housing tolerances to known distributions, resulting in a statistical mounted bearing setting range. This mounted setting takes into account any reductions in setting due to tight fits.

Bearing width increase can affect setting in applications such as outer-ring-adjusted, direct-mounting designs. In this case, a shim is inserted between the outer ring and a backing plate. Tight fits will affect calculation of the shim thickness. In other applications where axial tolerance summation calculations are made, tight fit effects must be taken into consideration.

For solid steel shafts and heavy-section steel housings, the change in setting is calculated as follows:

Inner ring setting reduction/width increase:

$$= 0.5 \left(\frac{K}{0.39} \right) \left(\frac{d}{d_o} \right) \delta_S$$

Outer ring setting reduction/width increase:

$$= 0.5 \left(\frac{K}{0.39} \right) \left(\frac{D_o}{D} \right) \delta_H$$

Interference fits on thin-walled shafts and light-section steel housings have a tendency to collapse the inner ring seat and stretch the outer ring seat, resulting in less change in bearing setting and overall width. The effects can be calculated according to the following formulas.

Inner ring setting reduction/width increase:

$$= 0.5 \left(\frac{K}{0.39} \right) \left\{ \frac{\left(\frac{d}{d_o} \right) \left[1 - \left(\frac{d_{si}}{d} \right)^2 \right]}{1 - \left(\frac{d_{si}}{d_o} \right)^2} \delta_S \right\}$$

Outer ring setting reduction/width increase:

$$= 0.5 \left(\frac{K}{0.39} \right) \left\{ \frac{\left(\frac{D_o}{D} \right) \left[1 - \left(\frac{D}{D_H} \right)^2 \right]}{1 - \left(\frac{D_o}{D_H} \right)^2} \delta_H \right\}$$

For shaft or housing material other than steel, consult your Timken engineer.

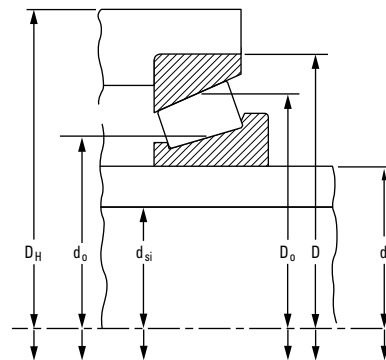


Fig. 12.
Parameters for calculation of fit effect on setting.

SETTING

Setting is defined as the axial clearance between roller and raceway. Establishing the setting at the time of assembly is an inherent advantage of tapered roller bearings. They can be set to provide optimum performance in almost any application. Fig. 13 gives an example of the relationship between fatigue life and bearing setting. Unlike some types of anti-friction bearings, tapered roller bearings do not rely strictly on housing or shaft fits to obtain a certain bearing setting. One ring can be moved axially relative to the other to obtain the desired bearing setting.

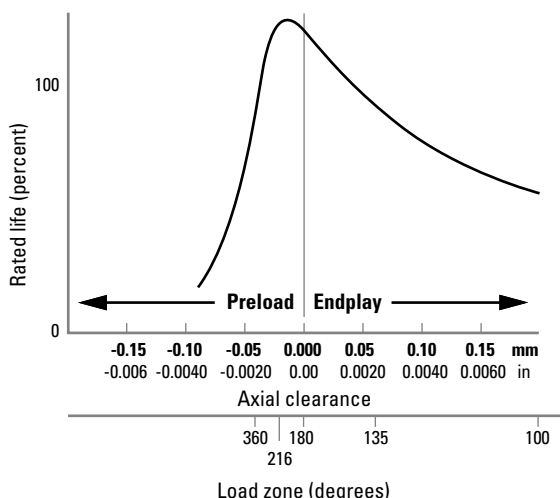


Fig. 13. Typical life vs. setting curve.

At assembly, the conditions of bearing setting are defined as:

- **Endplay (EP)** – An axial clearance between rollers and raceways producing a measurable axial shaft movement when a small axial force is applied – first in one direction then in the other, while oscillating or rotating the shaft. See fig. 14.
- **Preload (PL)** – An axial interference between rollers and raceways such that there is no measurable axial shaft movement when a small axial force is applied – in both directions – while oscillating or rotating the shaft.
- **Line-to-line** – A zero setting condition: the transitional point between endplay and preload.

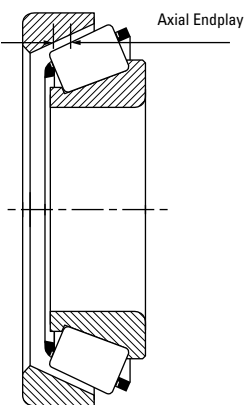


Fig. 14. Internal clearance – endplay.

Bearing setting obtained during initial assembly and adjustment is the cold or ambient bearing setting, and is established before the equipment is subjected to service.

Bearing setting during operation is known as the operating bearing setting, and is a result of changes in the ambient bearing setting due to thermal expansion and deflections encountered during service.

The ambient bearing setting necessary to produce the optimum operating bearing setting varies with the application. Application experience or testing generally determines optimum settings. Frequently, however, the exact relationship of ambient to operating bearing setting is unknown and an educated estimate has to be made. To determine a suggested ambient bearing setting for a specific application, contact your Timken engineer.

Generally, the ideal operating bearing setting is near zero to maximize bearing life (fig. 13). Most bearings are set with endplay at assembly to reach the desired near-zero setting at operating temperature.

There is an ideal bearing setting value for every application. To achieve this condition, the bearing setting must take into account deflection under load (radial + axial) as well as thermal expansions and material used.

1. Standard mounting

$$\text{Operating setting} = \text{mounted setting} \pm \text{temperature effect} + \text{deflection}$$

2. Pre-set assemblies

$$\text{Mounted EP or PL} = \text{bench EP or bench PL} - \text{effect of fits}$$

$$\text{Operating setting} = \text{mounted EP or PL (MEP or MPL)} + \text{deflection} \pm \text{temperature effect}$$

The temperature and fit effects will depend upon the type of mounting, bearing geometry and size, shaft and housing sizes, and material as defined in the following sections. Dimensional parameters affecting bearing setting are noted in fig. 15.

Fit effect⁽¹⁾

Solid shaft/heavy section housing

Setting Reduction/Width Increase for Single Inner Ring

$$= 0.5 \left(\frac{K}{0.39} \right) \left(\frac{d}{d_o} \right) \delta_S$$

Setting Reduction/Width Increase for Single Outer Ring

$$= 0.5 \left(\frac{K}{0.39} \right) \left(\frac{D}{D_o} \right) \delta_H$$

Hollow shaft/thin-wall section

Shaft Reduction/Width Increase for Single Inner Ring

$$= 0.5 \left(\frac{K}{0.39} \right) \left(\frac{d}{d_o} \right) \left[\frac{1 - \left(\frac{d_{si}}{d} \right)^2}{1 - \left(\frac{d_{si}}{d_o} \right)^2} \right] \delta_S$$

Shaft Reduction/Width Increase for Single Outer Ring

$$= 0.5 \left(\frac{K}{0.39} \right) \left(\frac{D_o}{D} \right) \left[\frac{1 - \left(\frac{D}{D_H} \right)^2}{1 - \left(\frac{D_o}{D_H} \right)^2} \right] \delta_H$$

⁽¹⁾These equations apply only to ferrous shaft and housing.

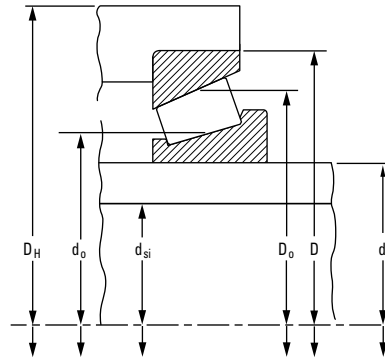


Fig. 15. Dimensional parameters affecting fit and temperature effects on setting.

Temperature effect

Direct mounting - setting change due to temperature

$$= \alpha_T \Delta T \left[\left(\frac{K_1}{0.39} \right) \left(\frac{D_{o1}}{2} \right) + \left(\frac{K_2}{0.39} \right) \left(\frac{D_{o2}}{2} \right) + L \right]$$

Indirect mounting - setting change due to temperature

$$= \alpha_T \Delta T \left[\left(\frac{K_1}{0.39} \right) \left(\frac{D_{o1}}{2} \right) + \left(\frac{K_2}{0.39} \right) \left(\frac{D_{o2}}{2} \right) - L \right]$$

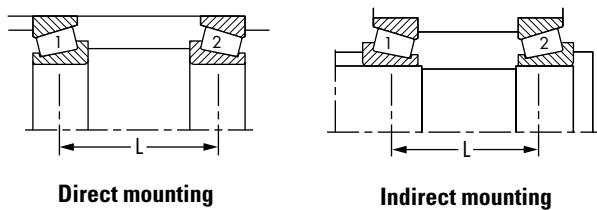


Fig. 16. Direct and indirect mounting.

Setting methods

Upper and lower limits of bearing setting values are determined by consideration of the following factors:

- Application type.
- Duty cycle/loading.
- Operational features of adjacent mechanical drive elements.
- Changes in bearing setting due to temperature differentials and deflections.
- Size of bearing and method of obtaining bearing setting.
- Lubrication method.
- Housing and shaft material.

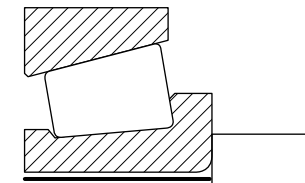
The setting value to be applied during assembly will depend on any changes that may occur during operation. In the absence of experience with bearings of similar size and operating conditions, a bearing setting range suggestion should be obtained from your Timken engineer.

These charts are guidelines for specifying shaft and housing fits related to particular operating conditions. Please contact your Timken engineer for more information.

FITTING PRACTICE TABLES

TAPERED ROLLER BEARINGS

INNER RING – Industrial Equipment Classes K and N (Metric)



Deviation from nominal (maximum) bearing bore and resultant fit.

T= Tight
L = Loose

TABLE 22. TAPERED ROLLER BEARINGS – INNER RING
Industrial Equipment Classes K and N (Metric)

Inner Ring Bore		Tolerance	Rotating Inner Ring			Rotating or Stationary Inner Ring		
Range			Ground Seat			Unground Seat or Ground Seat		
Over	Incl.		Constant Loads With Moderate Shock			Heavy Loads, High Speed or Shock		
mm in.	mm in.	mm in.	Inner Ring Seat Deviation mm in.	Resultant Fit mm in.	Symbol	Inner Ring Seat Deviation mm in.	Resultant Fit mm in.	Symbol
10.000 0.3937	18.000 0.7087	-0.012 0.000 -0.0005 0.0000	+0.018 +0.007 +0.0007 +0.0003	0.030T 0.007T 0.0012T 0.0003T	m6	+0.023 +0.012 +0.0009 +0.0005	0.035T 0.012T 0.0014T 0.0005T	n6
18.000 0.7087	30.000 1.1811	-0.012 0.000 -0.0005 0.0000	+0.021 +0.008 +0.0008 +0.0003	0.033T 0.008T 0.0013T 0.0003T	m6	+0.028 +0.015 +0.0011 +0.0006	0.040T 0.015T 0.0016T 0.0006T	n6
30.000 1.1811	50.000 1.9685	-0.012 0.000 -0.0005 0.0000	+0.025 +0.009 +0.0010 +0.0004	0.037T 0.009T 0.0015T 0.0004T	m6	+0.033 +0.017 +0.0013 +0.0007	0.045T 0.017T 0.0018T 0.0007T	n6
50.000 1.9685	80.000 3.1496	-0.015 0.000 -0.0006 0.0000	+0.030 +0.011 +0.0012 +0.0004	0.045T 0.011T 0.0018T 0.0005T	m6	+0.039 +0.020 +0.0015 +0.0008	0.054T 0.020T 0.0021T 0.0008T	n6
80.000 3.1496	120.000 4.7244	-0.020 0.000 -0.0008 0.0000	+0.035 +0.013 +0.0014 +0.0005	0.055T 0.013T 0.0022T 0.0005T	m6	+0.045 +0.023 +0.0019 +0.0010	0.065T 0.023T 0.0027T 0.0010T	n6
120.000 4.7244	180.000 7.0866	-0.025 0.000 -0.0010 0.0000	+0.052 +0.027 +0.0020 +0.0011	0.077T 0.027T 0.0030T 0.0011T	n6	+0.068 +0.043 +0.0027 +0.0017	0.093T 0.043T 0.0037T 0.0017T	p6
180.000 7.0866	200.000 7.8740	-0.030 0.000 -0.0012 0.0000	+0.060 +0.031 +0.0024 +0.0012	0.090T 0.031T 0.0035T 0.0012T	n6	+0.106 +0.077 +0.0042 +0.0030	0.136T 0.077T 0.0054T 0.0030T	r6
200.000 7.8740	225.000 8.8583					+0.109 +0.080 +0.0043 +0.0031	0.139T 0.080T 0.0055T 0.0031T	
225.000 8.8583	250.000 9.8425					+0.113 +0.084 0.0044 +0.0033	0.143T 0.084T 0.0056T 0.0033T	
250.000 9.8425	280.000 11.0236	-0.035 0.000 -0.0014 0.0000	+0.066 +0.033 +0.0026 +0.0013	0.101T 0.033T 0.0040T 0.0013T	n6	+0.146 +0.094 +0.0057 +0.0037	0.181T 0.094T 0.0071T 0.0037T	r7
280.000 11.0236	315.000 12.4016					+0.150 +0.098 +0.0059 +0.0039	0.185T 0.098T 0.0073T 0.0039T	

These charts are guidelines for specifying shaft and housing fits related to particular operating conditions. Please contact your Timken engineer for more information.

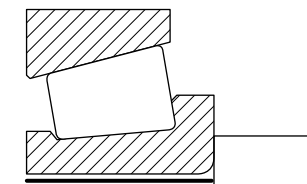
Stationary Inner Ring											
Unground Seat			Ground Seat			Unground Seat			Hardened and Ground Seat		
Moderate Loads, No Shock			Moderate Loads, No Shock			Sheaves, Wheels, Idlers			Wheel Spindles		
Inner Ring Seat Deviation	Resultant Fit	Symbol	Inner Ring Seat Deviation	Resultant Fit	Symbol	Inner Ring Seat Deviation	Resultant Fit	Symbol	Inner Ring Seat Deviation	Resultant Fit	Symbol
mm in.	mm in.		mm in.	mm in.		mm in.	mm in.		mm in.	mm in.	
0.000 -0.011 0.0000 -0.0004	0.012T 0.011L 0.0005T 0.0004L	h6	-0.006 -0.017 -0.0002 -0.0007	0.006T 0.017L 0.0002T 0.0007L	g6	-0.006 -0.017 -0.00025 -0.00065	0.006T 0.017L -0.00025T 0.00065L	g6	-0.016 -0.027 -0.0006 -0.0011	0.004L 0.027L 0.0002L 0.0011L	f6
0.000 -0.013 0.0000 -0.0005	0.012T 0.013L 0.0005T 0.0005L	h6	-0.007 -0.020 -0.0003 -0.0008	0.005T 0.020L 0.0002T 0.0008L	g6	-0.007 -0.020 -0.0003 -0.0008	0.005T 0.020L 0.0002T 0.0008L	g6	-0.020 -0.033 -0.0008 -0.0013	0.008L 0.033L 0.0003L 0.0013L	f6
0.000 -0.016 0.0000 -0.0006	0.012T 0.016L 0.0005T 0.0006L	h6	-0.009 -0.025 -0.0004 -0.0010	0.003T 0.025L 0.0001T 0.0010L	g6	-0.009 -0.025 -0.0004 -0.0010	0.003T 0.025L 0.0001T 0.0010L	g6	-0.025 -0.041 -0.0010 -0.0016	0.013L 0.041L 0.0005L 0.0016L	f6
0.000 -0.019 0.0000 -0.0007	0.015T 0.019L 0.0006T 0.0007L	h6	-0.010 -0.029 -0.0004 -0.0011	0.005T 0.029L 0.0002T 0.0011L	g6	-0.010 -0.029 -0.0004 -0.0011	0.005T 0.029L 0.0002T 0.0011L	g6	-0.030 -0.049 -0.0012 -0.0019	0.015L 0.049L 0.0006L 0.0019L	f6
0.000 -0.022 0.0000 -0.0009	0.020T 0.022L 0.0008T 0.0009L	h6	-0.012 -0.034 -0.0005 -0.0014	0.008T 0.034L 0.0003T 0.0014L	g6	-0.012 -0.034 -0.0005 -0.0014	0.008T 0.034L 0.0003T 0.0014L	g6	-0.036 -0.058 -0.0014 -0.0023	0.016L 0.058L 0.0006L 0.0023L	f6
0.000 -0.025 0.0000 -0.0010	0.025T 0.025L 0.0010T 0.0010L	h6	-0.014 -0.039 -0.0006 -0.0016	0.011T 0.039L 0.0004T 0.0016L	g6	-0.014 -0.039 -0.0006 -0.0016	0.011T 0.039L 0.0004T 0.0016L	g6	-0.043 -0.068 -0.0016 -0.0026	0.018L 0.068L 0.0006L 0.0026L	f6
0.000 -0.029 0.0000 -0.0011	0.030T 0.029L 0.0012T 0.0011L	h6	-0.015 -0.044 -0.0006 -0.0017	0.015T 0.044L 0.0006T 0.0017L	g6	-0.015 -0.044 -0.0006 -0.0017	0.015T 0.044L 0.0006T 0.0017L	g6	-0.050 -0.079 -0.0020 -0.0031	0.020L 0.079L 0.0008L 0.0031L	f6
0.000 -0.032 0.0000 -0.0012	0.035T 0.032L 0.0014T 0.0012L	h6	-0.017 -0.049 -0.0007 -0.0019	0.018T 0.049L 0.0007T 0.0019L	g6	-0.017 -0.049 -0.0007 -0.0019	0.018T 0.049L 0.0007T 0.0019L	g6	-0.056 -0.068 -0.0022 -0.0027	0.021L 0.088L 0.0008L 0.0035L	f6

Continued on next page.

FITTING PRACTICE TABLES

These charts are guidelines for specifying shaft and housing fits related to particular operating conditions. Please contact your Timken engineer for more information.

INNER RING – Industrial Equipment Classes K and N (Metric)



Deviation from nominal (maximum)
bearing bore and resultant fit.

T = Tight
L = Loose

Table 22 continued.

Inner Ring Bore		Tolerance	Rotating Inner Ring			Rotating or Stationary Inner Ring		
Range			Ground Seat			Unground Seat or Ground Seat		
Over	Incl.		Constant Loads With Moderate Shock			Heavy Loads, High Speed or Shock		
mm in.	mm in.	mm in.	Inner Ring Seat Deviation	Resultant Fit	Symbol	Inner Ring Seat Deviation	Resultant Fit	Symbol
315.000 12.4016	355.000 13.9764	-0.040 0.000 -0.0016 0.0000	+0.073 +0.037 +0.0029 +0.0015	0.113T 0.037T 0.0044T 0.0015T	n6	+0.165 +0.108 +0.0065 +0.0043	0.205T 0.108T 0.0081T 0.0043T	r7
355.000 13.9764	400.000 15.7480					+0.171 +0.114 +0.0067 +0.0045	0.211T 0.114T 0.0083T 0.0045T	
400.000 15.7580	450.000 17.7165	-0.045 0.000 -0.0018 0.0000	+0.080 +0.040 +0.0031 +0.0016	0.0125T 0.040T 0.0049T 0.0016T	n6	+0.189 +0.126 +0.0074 +0.0092	0.234T 0.126T 0.0092T 0.0050T	r7
450.000 17.7165	500.000 19.6850					+0.195 +0.132 +0.0077 +0.0052	0.240T 0.132T 0.0094T 0.0052T	
500.000 29.6850	630.000 24.8032	-0.050 0.000 -0.0020 0.0000	+0.100 +0.050 +0.0039 +0.0020	0.150T 0.050T 0.0059T 0.0020T	-	+0.200 +0.125 +0.0079 +0.0049	0.250T 0.125T 0.0098T 0.0049T	-
630.000 24.8032	800.000 31.4961	-0.080 0.000 -0.0031 0.0000	+0.125 +0.050 +0.0049 +0.0020	0.205T 0.050T 0.0081T 0.0020T	-	+0.225 +0.150 +0.0089 +0.0059	0.305T 0.105T 0.0102T 0.0041T	-
800.000 31.4961	1000.000 39.3701	-0.100 0.000 -0.0039 0.0000	+0.150 +0.050 +0.0059 +0.0020	0.250T 0.050T 0.0098T 0.0020T	-	+0.275 +0.175 +0.0108 +0.0069	0.375T 0.175T 0.0148T 0.0069T	-

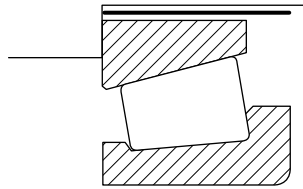
These charts are guidelines for specifying shaft and housing fits related to particular operating conditions. Please contact your Timken engineer for more information.

Stationary Inner Ring											
Unground Seat			Ground Seat			Unground Seat			Hardened and Ground Seat		
Moderate Loads, No Shock			Moderate Loads, No Shock			Sheaves, Wheels, Idlers			Wheel Spindles		
Inner Ring Seat Deviation	Resultant Fit	Symbol	Inner Ring Seat Deviation	Resultant Fit	Symbol	Inner Ring Seat Deviation	Resultant Fit	Symbol	Inner Ring Seat Deviation	Resultant Fit	Symbol
mm in.	mm in.		mm in.	mm in.		mm in.	mm in.		mm in.	mm in.	
0.000 -0.036 0.0000 -0.0014	0.040T 0.036L 0.0016T 0.0014L	h6	-0.018 -0.075 -0.0007 -0.0030	0.022T 0.075L 0.0009T 0.0030L	g7	-0.018 -0.075 -0.0007 -0.0029	0.022T 0.075L 0.0009T 0.0029L	g7	-	-	-
0.000 -0.040 0.0000 -0.0020	0.045T 0.040L 0.0018T 0.0016L	h6	-0.020 -0.083 -0.0008 -0.0033	0.025T 0.083L 0.0008T 0.0033L	g7	-0.020 -0.083 -0.0008 -0.0033	0.025T 0.083L 0.0008T 0.0033L	g7	-	-	-
0.000 -0.050 0.0000 -0.0020	0.050T 0.050L 0.0020T 0.0020L	-	-0.050 -0.100 -0.0020 -0.0039	0.000 0.100L 0.0000 0.0039L	-	-0.050 -0.100 -0.0020 -0.0039	0.000 0.100L 0.0000 0.0039L	-	-	-	-
0.000 -0.075 0.0000 -0.0030	0.080T 0.075L 0.0031T 0.0030L	-	-0.080 -0.150 -0.0031 -0.0059	0.000 0.150L 0.0000 0.0059L	-	-0.080 -0.150 -0.0031 -0.0059	0.000 0.150L 0.0000 0.0059L	-	-	-	-
0.000 -0.100 0.0000 -0.0039	0.100T 0.100L 0.0039T 0.0039L	-	-0.100 -0.200 -0.0039 -0.0079	0.000 0.200L 0.0000 0.0079L	-	-0.100 -0.200 -0.0039 -0.0079	0.000 0.200L 0.0000 0.0079L	-	-	-	-

FITTING PRACTICE TABLES

These charts are guidelines for specifying shaft and housing fits related to particular operating conditions. Please contact your Timken engineer for more information.

OUTER RING – Industrial Equipment Classes K and N (Metric)



Deviation from nominal (maximum)
bearing O.D. and resultant fit.

T= Tight
L= Loose

TABLE 23. TAPERED ROLLER BEARINGS – OUTER RING – Industrial Equipment Classes K and N (Metric)

Outer Ring O.D.		Tolerance	Stationary Cup									Rotating Cup		
Range			Floating or Clamped			Adjustable			Nonadjustable or in Carriers			Nonadjustable or in Carriers or Sheaves - Clamped		
Over	Incl.		Outer Ring Seat Deviation	Resultant Fit	Symbol	Outer Ring Seat Deviation	Resultant Fit	Symbol	Outer Ring Seat Deviation	Resultant Fit	Symbol	Outer Ring Seat Deviation	Resultant Fit	Symbol
mm in.	mm in.	mm in.	mm in.	mm in.	mm in.	mm in.	mm in.	mm in.	mm in.	mm in.	mm in.	mm in.	mm in.	
18.000 0.7087	30.000 1.1811	0.000 -0.012 0.0000 -0.0005	+0.007 +0.028 0.0003 +0.0011	0.007L 0.040L 0.0003L 0.0016L	G7	-0.009 +0.012 -0.0004 +0.0005	0.009T 0.024L 0.0004T 0.0009L	J7	-0.035 -0.014 -0.0014 -0.0005	0.035T 0.002T 0.0014T 0.0001T	P7	-0.041 -0.020 -0.0016 -0.0009	0.041T 0.008T 0.0016T 0.0003T	R7
30.000 1.1811	50.000 1.9685	0.000 -0.014 0.0000 -0.0006	+0.009 +0.034 +0.0004 +0.0013	0.009L 0.048L 0.0004L 0.0019L	G7	-0.011 +0.014 -0.0004 +0.0006	0.011T 0.028L 0.0004T 0.0011L	J7	-0.042 -0.017 -0.0017 -0.0007	0.042T 0.003T 0.0017T 0.0001T	P7	-0.050 -0.025 -0.0020 -0.0010	0.050T 0.011T 0.0020T 0.0004T	R7
50.000 1.9685	65.000 2.5591	0.000 -0.016 0.0000 -0.0006	+0.010 +0.040 +0.0004 +0.0016	0.010L 0.056L 0.0004L 0.0022L	G7	-0.012 +0.018 -0.0005 +0.0007	0.012T 0.034L 0.0005T 0.0013L	J7	-0.051 -0.021 -0.0020 -0.0008	0.051T 0.005T 0.0020T 0.0002T	P7	-0.060 -0.030 -0.0024 -0.0012	0.060T 0.014T 0.0024T 0.0006T	R7
65.000 2.5591	80.000 3.1496	0.000 -0.018 0.0000 -0.0007	+0.012 +0.047 +0.0005 +0.0019	0.012L 0.065L 0.0005L 0.0026L	G7	-0.013 +0.022 -0.0005 +0.0009	0.013T 0.040L 0.0005T 0.0016L	J7	-0.059 -0.024 -0.0023 -0.0009	0.059T 0.006T 0.0023T 0.0002T	P7	-0.073 -0.038 -0.0029 -0.0015	0.073T 0.020T 0.0029T 0.0008T	R7
80.000 3.1496	100.000 3.9370	0.000 -0.018 0.0000 -0.0007	+0.012 +0.047 +0.0005 +0.0019	0.012L 0.065L 0.0005L 0.0026L	G7	-0.013 +0.022 -0.0005 +0.0009	0.013T 0.040L 0.0005T 0.0016L	J7	-0.059 -0.024 -0.0023 -0.0009	0.059T 0.006T 0.0023T 0.0002T	P7	-0.073 -0.038 -0.0029 -0.0015	0.073T 0.020T 0.0029T 0.0008T	R7
100.000 3.9370	120.000 4.7244	0.000 -0.018 0.0000 -0.0008	+0.012 +0.047 +0.0005 +0.0019	0.012L 0.065L 0.0005L 0.0026L	G7	-0.013 +0.022 -0.0005 +0.0009	0.013T 0.040L 0.0005T 0.0016L	J7	-0.059 -0.024 -0.0023 -0.0009	0.059T 0.006T 0.0023T 0.0002T	P7	-0.073 -0.038 -0.0029 -0.0015	0.073T 0.020T 0.0029T 0.0008T	R7
120.000 4.7244	140.000 5.5188	0.000 -0.020 0.0000 -0.0008	+0.014 +0.054 +0.0006 +0.0021	0.014L 0.074L 0.0006L 0.0029L	G7	-0.014 +0.026 -0.0006 +0.0010	0.014T 0.046L 0.0006T 0.0018L	J7	-0.068 -0.028 -0.0027 -0.0011	0.068T 0.074T 0.0027T 0.0003T	P7	-0.088 -0.048 -0.0035 -0.0019	0.088T 0.028T 0.0035T 0.0011T	R7
140.000 5.5188	150.000 5.9055	0.000 -0.020 0.0000 -0.0010	+0.014 +0.054 +0.0006 +0.0021	0.014L 0.079L 0.0006L 0.0031L	G7	-0.014 +0.026 -0.0006 +0.0010	0.014L 0.051L 0.0006T 0.0020L	J7	-0.068 -0.028 -0.0027 -0.0011	0.068T 0.003T 0.0027T 0.0001T	P7	-0.090 -0.050 -0.0035 -0.0020	0.090T 0.030T 0.0035T 0.0012T	R7
150.000 5.9055	160.000 6.2992	0.000 -0.025 0.0000 -0.0010	+0.014 +0.054 +0.0006 +0.0021	0.014L 0.079L 0.0006L 0.0031L	G7	-0.014 +0.026 -0.0006 +0.0010	0.014L 0.051L 0.0006T 0.0020L	J7	-0.068 -0.028 -0.0027 -0.0011	0.068T 0.003T 0.0027T 0.0001T	P7	-0.090 -0.050 -0.0035 -0.0020	0.090T 0.025T 0.0035T 0.0010T	R7
160.000 6.2992	180.000 7.0866	0.000 -0.025 0.0000 -0.0010	+0.014 +0.054 +0.0006 +0.0021	0.014L 0.079L 0.0006L 0.0031L	G7	-0.014 +0.026 -0.0006 +0.0010	0.014L 0.051L 0.0006T 0.0020L	J7	-0.068 -0.028 -0.0027 -0.0011	0.068T 0.003T 0.0027T 0.0001T	P7	-0.093 -0.053 -0.0037 -0.0021	0.093T 0.028T 0.0037T 0.0011T	R7

Continued on next page.

These charts are guidelines for specifying shaft and housing fits related to particular operating conditions. Please contact your Timken engineer for more information.

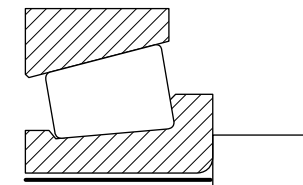
Table 23 continued.

Outer Ring O.D.		Tolerance	Stationary Cup									Rotating Cup		
Range			Floating or Clamped			Adjustable			Nonadjustable or in Carriers			Nonadjustable or in Carriers or Sheaves - Clamped		
Over	Incl.		Outer Ring Seat Deviation	Resultant Fit	Symbol	Outer Ring Seat Deviation	Resultant Fit	Symbol	Outer Ring Seat Deviation	Resultant Fit	Symbol	Outer Ring Seat Deviation	Resultant Fit	Symbol
mm in.	mm in.	mm in.	mm in.		mm in.	mm in.		mm in.	mm in.		mm in.	mm in.		
180.000 7.0866	200.000 7.8740	0.000 -0.030 0.0000 -0.0012	+0.015 +0.061 +0.0006 +0.0024	0.015L 0.091L 0.0006L 0.0036L	G7	-0.016 +0.030 -0.00076 +0.0012	0.016T 0.060L 0.0006T 0.0024L	J7	-0.079 -0.033 -0.0031 -0.0014	0.079T 0.003T 0.0031T 0.0001T	P7	-0.106 -0.060 -0.0042 -0.0024	0.106T 0.030T 0.0042T 0.0012T	R7
200.000 7.8740	225.000 8.8583											-0.109 -0.063 -0.0043 -0.0025	0.109T 0.033T 0.0043T 0.0013T	
225.000 8.8583	250.000 9.8425											-0.113 -0.067 -0.0044 -0.0026	0.113T 0.037T 0.0044T 0.0015T	
250.000 9.8425	280.000 11.0236	0.000 -0.035 0.0000 -0.0014	+0.017 +0.069 +0.0007 +0.0027	0.017L 0.104L 0.0007L 0.0041L	G7	-0.016 +0.036 -0.0006 +0.0013	0.016T 0.071L 0.0006T 0.0028L	J7	-0.088 -0.036 -0.0035 -0.0014	0.088T 0.001T 0.0035T 0.0000	P7	-0.126 -0.074 -0.0050 -0.0029	0.126T 0.039T 0.0050T 0.0015T	R7
280.000 11.0236	315.000 12.4016											-0.130 -0.078 -0.0051 -0.0031	0.130T 0.043T 0.0051T 0.0017T	
315.000 12.4016	355.000 13.9764	0.000 -0.040 0.0000 -0.0016	+0.062 +0.098 +0.0024 +0.0039	0.062L 0.138L 0.0024L 0.0054L	F6	-0.018 +0.039 -0.0007 +0.0015	0.018T 0.079L 0.0007T 0.0031L	J7	-0.098 -0.041 -0.0039 -0.0016	0.098T 0.001T 0.0039T 0.0001T	P7	-0.144 -0.087 -0.0057 -0.0034	0.144T 0.047T 0.0057T 0.0019T	R7
355.000 13.9764	400.000 15.7480											-0.150 -0.093 -0.0059 -0.0037	0.150T 0.053T 0.0059T 0.0021T	
400.000 15.7480	450.000 17.7165	0.000 -0.045 0.0000 -0.0018	+0.068 +0.095 +0.0027 +0.0037	0.068L 0.140L 0.0027L 0.0055L	F5	-0.020 +0.043 -0.0008 +0.0017	0.020T 0.088L 0.0008T 0.0035L	J7	-0.108 -0.045 -0.0043 -0.0018	0.108T 0.000 0.0043T 0.0000	P7	-0.166 -0.103 -0.0065 -0.0041	0.166T 0.058T 0.0065T 0.0023T	R7
450.000 17.7165	500.000 19.6850											-0.172 -0.109 -0.0068 -0.0043	0.172T 0.064T 0.0068T 0.0025T	
500.000 19.6850	630.000 24.8032	0.000 -0.050 0.0000 -0.0020	+0.065 +0.115 +0.0026 +0.0045	0.065L 0.165L 0.0026L 0.0065L	-	-0.022 +0.046 -0.0009 +0.0018	0.022T 0.096L 0.0009T 0.0038L	-	-0.118 -0.050 -0.0046 -0.0020	0.118T 0.000 0.0046T 0.0000	-	-0.190 -0.120 -0.0075 -0.0047	0.190T 0.070T 0.0075T 0.0028T	R7
630.000 24.8032	800.000 31.4961	0.000 -0.080 0.0000 -0.0031	+0.075 +0.150 +0.0030 +0.0059	0.075L 0.225L 0.0030L 0.0089L	-	-0.025 +0.050 -0.0098 +0.0020	0.025T 0.130L 0.0098T 0.0051L	-	-0.150 -0.075 -0.0059 -0.0030	0.150T 0.000 0.0059T 0.0000	-	-	-	R7
800.000 31.4961	1000.000 39.3701	0.000 -0.100 0.0000 -0.0039	+0.075 +0.175 +0.0030 +0.0069	0.075L 0.275L 0.0030L 0.0108L	-	-0.025 +0.075 -0.0098 +0.0030	0.025T 0.175L 0.0098T 0.0069L	-	-0.200 -0.100 -0.0079 -0.0039	0.200T 0.000 0.0079T 0.0000	-	-	-	R7

FITTING PRACTICE TABLES

These charts are guidelines for specifying shaft and housing fits related to particular operating conditions. Please contact your Timken engineer for more information.

INNER RING – Industrial Equipment Classes 4 and 2 (Inch)



Deviation from nominal (minimum) bearing bore and resultant fit.

T = Tight
L = Loose

TABLE 24. TAPERED ROLLER BEARINGS – INNER RING – Industrial Equipment Classes 4 and 2 (Inch)

Inner Ring Bore		Tolerance ⁽¹⁾	Rotating Inner Ring		Rotating or Stationary Inner Ring		Stationary Inner Ring								
Range			Ground Seat		Unground or Ground Seat		Unground Seat		Ground Seat		Unground Seat		Hardened and Ground Seat		
Over	Incl.		Constant Loads With Moderate Shock		Heavy Loads, or High Speed Or Shock		Moderate Loads, No Shock		Moderate Loads, No Shock		Sheaves, Wheels, Idlers		Wheel Spindles		
		Inner Ring Seat Deviation	Resultant Fit	Inner Ring Seat Deviation	Resultant Fit	Inner Ring Seat Deviation	Resultant Fit	Inner Ring Seat Deviation	Resultant Fit	Inner Ring Seat Deviation	Resultant Fit	Inner Ring Seat Deviation	Resultant Fit	Inner Ring Seat Deviation	Resultant Fit
mm in.	mm in.	mm in.	mm in.	mm in.	mm in.	mm in.	mm in.	mm in.	mm in.	mm in.	mm in.	mm in.	mm in.	mm in.	mm in.
0.000 0.0000	76.200 3.0000	0.000 +0.013 0.0000 +0.0005	+0.038 ⁽²⁾ +0.026 0.0015 +0.0010	0.038T 0.012T 0.0015T 0.0005T	+0.064 +0.038 +0.0025 +0.0015	0.064T 0.025T 0.0025T 0.0010T	+0.013 0.000 +0.0005T 0.0000	0.013T 0.013L 0.0005T 0.0005L	0.000 -0.013 0.0000 -0.0005	0.000 0.026L 0.0000 0.0010L	0.000 -0.013 0.0000 -0.0005	0.000 0.026L 0.0000 0.0010L	-0.005 -0.018 -0.0002 -0.0007	0.005L 0.031L 0.0002L 0.0012L	
76.200 3.0000	304.800 12.0000	0.000 +0.025 0.0000 +0.0010	+0.064 +0.038 +0.0025 +0.0015	0.064T 0.013T 0.0025T 0.0005T	Use Average Tight Inner Ring Fit of 0.0005 mm/mm (0.0005in./in.) of Inner Ring Bore ⁽³⁾	0.000 0.000 0.0000 0.0010L	+0.025 0.000 +0.0010 0.0000	0.025T 0.025L 0.0010T 0.0010L	0.000 -0.025 0.0000 -0.0010	0.000 0.051L 0.0000 0.0020L	0.000 0.000 0.0000 -0.0010	0.000 0.051L 0.0000 0.0020L	-0.005 -0.031 -0.0002 -0.0012	0.005L 0.056L 0.0002L 0.0022L	
304.800 12.0000	609.600 24.0000	0.000 +0.051 0.0000 +0.0020	+0.127 +0.076 +0.0050 +0.0030	0.127T 0.025T 0.0050T 0.0010T			+0.051 0.000 +0.0020 0.0000	0.051T 0.051L 0.0020T 0.0020L	0.000 -0.051 0.0000 -0.0020	0.000 0.102L 0.0000 0.0040L	0.000 -0.051 0.0000 -0.0020	0.000 0.102L 0.0000 0.0040L	-	-	
609.600 24.0000	914.400 36.0000	0.000 +0.076 0.0000 +0.0030	+0.191 +0.114 +0.0075 +0.0015T	0.191T 0.114T 0.0075T 0.0015T			+0.076 0.000 +0.0030 0.0000	0.076T 0.076L 0.0030T 0.0030L	0.000 -0.076 0.0000 -0.0030	0.000 0.152L 0.0000 0.0060L	0.000 -0.076 0.0000 -0.0030	0.000 0.152L 0.0000 0.0060L	-	-	

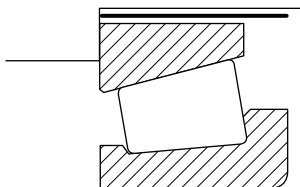
⁽¹⁾Does not apply to TNASW and TNASWE type bearings.

⁽²⁾Example: If the minimum inner ring bore is 76.200 mm (3.0000 in.) the suggested shaft size = 76.238 mm (3.0015 in.) to 76.225 mm (3.0010 in.) for an inner ring fit of 0.038 mm (0.0015 in.) tight to 0.012 mm (0.0005 in.) tight.

⁽³⁾For inner ring bores between 76.200 mm (3.0000 in.) and 101.600 mm (4.0000 in.) use a minimum fit of 0.025 mm (0.0001 in.) tight.

These charts are guidelines for specifying shaft and housing fits related to particular operating conditions. Please contact your Timken engineer for more information.

**OUTER RING –
Industrial Equipment
Classes 4 and 2 (Inch)**



Deviation from nominal (minimum)
bearing O.D. and resultant fit.

T= Tight
L = Loose

TABLE 25. TAPERED ROLLER BEARINGS – OUTER RING – Industrial Equipment Classes 4 and 2 (Inch)

Outer Ring O.D.		Tolerance	Stationary Outer Ring				Stationary Or Rotating Outer Ring		Rotating Outer Ring	
Range			Floating or Clamped		Adjustable		Non-adjustable or In Carriers, Sheaves - Clamped		Sheaves - Unclamped ⁽¹⁾	
Over	Incl.		Outer Ring Seat Deviation	Resultant Fit	Outer Ring Seat Deviation	Resultant Fit	Outer Ring Seat Deviation	Resultant Fit	Outer Ring Seat Deviation	Resultant Fit
mm in.	mm in.	mm in.	mm in.	mm in.	mm in.	mm in.	mm in.	mm in.	mm in.	
0.000 0.0000	76.200 3.0000	+0.025 0.000 +0.0010 0.0000	+0.050 +0.076 +0.0020 +0.0030	0.026L 0.076L 0.0010L 0.0030L	0.000 +0.025 0.0000 +0.0010	0.025T 0.025L 0.0010T 0.0010L	-0.039 -0.013 -0.0015 -0.0005	0.064T 0.013T 0.0025T 0.0005T	-0.077 -0.051 -0.0030 -0.0020	0.102T 0.051T 0.0040T 0.0020T
76.200 3.0000	127.000 5.0000	+0.025 0.000 +0.0010 0.0000	+0.050 +0.076 +0.0020 +0.0030	0.026L 0.076L 0.0010L 0.0030L	0.000 +0.025 0.0000 +0.0010	0.025T 0.025L 0.0010T 0.0010L	-0.051 -0.025 -0.0020 -0.0010	0.076T 0.025T 0.0030T 0.0010T	-0.077 -0.051 -0.0030 -0.0020	0.102T 0.051T 0.0040T 0.0020T
127.000 5.0000	304.800 12.0000	+0.025 0.000 +0.0010 0.0000	+0.050 +0.076 +0.0020 +0.0030	0.026L 0.076L 0.0010L 0.0030L	0.000 +0.051 0.0000 +0.0020	0.025T 0.051L 0.0010T 0.0020L	-0.051 -0.025 -0.0020 -0.0010	0.076T 0.025T 0.0030T 0.0010T	-0.077 -0.051 -0.0030 -0.0020	0.102T 0.051T 0.0040T 0.0020T
304.800 12.0000	609.600 24.0000	+0.051 0.000 +0.0020 0.0000	+0.102 +0.152 +0.0040 +0.0060	0.051L 0.152L 0.0020L 0.0060L	+0.026 +0.076 +0.0010 +0.0030	0.025T 0.076L 0.0010T 0.0030L	-0.076 -0.025 -0.0030 -0.0010	0.127T 0.025T 0.0050T 0.0010T	-0.102 -0.051 -0.0040 -0.0020	0.153T 0.051T 0.0060T 0.0020T
609.600 24.0000	914.400 36.0000	+0.076 0.000 +0.0030 0.0000	+0.152 +0.229 +0.0060 +0.0090	0.076L 0.229L 0.0030L 0.0090L	+0.051 +0.127 +0.0020 +0.0050	0.025T 0.0127L 0.0010T 0.0050L	-0.102 -0.025 -0.0040 -0.0010	0.178T 0.025T 0.0070T 0.0010T	-	-

⁽¹⁾Unclamped outer ring design is applicable only to sheaves with negligible fleet angle.

FITTING PRACTICE TABLES

These charts are guidelines for specifying shaft and housing fits related to particular operating conditions. Please contact your Timken engineer for more information.

INNER RING – Automotive Equipment Class 4 and 2 (Inch)

Deviation from nominal (minimum) bearing bore and resultant fit.

T= Tight
L = Loose

**TABLE 26. TAPERED ROLLER BEARINGS – INNER RING
Automotive Equipment Classes 4 and 2 (Inch)**

Inner Ring Bore		Tolerance	Shaft O.D.					
			Stationary Inner Ring		Rotating Inner Ring			
			Front Wheels Rear Wheel (Full-Floating Axles) Trailer Wheels		Rear Wheels (Semi-Floating Axles)		Rear Wheels (Unit-Bearing) (Semi-Floating Axles)	
Over	Incl.	Non-adjustable						
mm in.	mm in.	mm in.	Shaft O.D. Deviation	Resultant Fit	Shaft O.D. Deviation	Resultant Fit	Shaft O.D. Deviation	Resultant Fit
0.000 0.0000	76.200 3.0000	0.000 +0.0013 0.0000 +0.0005	-0.005 -0.018 -0.0002 -0.0007	0.005L 0.031L 0.0002L 0.0012L	+0.051 +0.038 +0.0020 +0.0015	0.051T 0.025T 0.0020T 0.0010T	+0.056 +0.038 +0.0022 +0.0015	0.056T 0.025T 0.0022T 0.0010T
76.200 3.0000	304.800 12.0000	0.000 +0.0025 0.0000 +0.0010	-0.0013 -0.038 -0.0050 -0.0015	0.013L 0.063L 0.0005L 0.0025L	+0.076 +0.051 +0.0030 +0.0020	0.076T 0.026T 0.0030T 0.0010T	–	–

OUTER RING – Automotive Equipment Classes 4 and 2 (Inch)

**TABLE 27. TAPERED ROLLER BEARINGS – OUTER RING
Automotive Equipment Classes 4 and 2 (Inch)**

Outer Ring O.D.		Tolerance	Housing Bore	
			Rotating Outer Ring	
			Front Wheels	Rear Wheels (Full-Floating Trailer Wheels)
Over	Incl.	Non-adjustable		
mm in.	mm in.	mm in.	Housing Bore Deviation	Resultant Fit
0.000 0.0000	76.200 3.0000	+0.025 0.000 +0.0010 0.0000	-0.051 -0.013 -0.0020 -0.0005	0.076T 0.013T 0.0030T 0.0005T
76.200 3.0000	127.000 5.0000	+0.025 0.000 +0.0010 0.0000	-0.077 -0.025 -0.0030 -0.0010	0.102T 0.025T 0.0040T 0.0010T
127.000 5.0000	304.800 12.0000	+0.025 0.000 +0.0010 0.0000	-0.077 -0.025 -0.0030 -0.0010	0.102T 0.025T 0.0040T 0.0010T

These charts are guidelines for specifying shaft and housing fits related to particular operating conditions. Please contact your Timken engineer for more information.

Shaft O.D.									
Rotating Inner Ring									
Pinion					Differential			Transaxles Transmissions Transfer Cases Cross Shafts	
Clamped		Collapsible Spacer		Non-adjustable		Non-adjustable		Non-adjustable	
Shaft O.D. Deviation	Resultant Fit	Shaft O.D. Deviation	Resultant Fit	Shaft O.D. Deviation	Resultant Fit	Shaft O.D. Deviation	Resultant Fit	Shaft O.D. Deviation	Resultant Fit
mm in.	mm in.	mm in.	mm in.	mm in.	mm in.	mm in.	mm in.	mm in.	mm in.
+0.025 +0.013 +0.0010 +0.0005	0.025T 0.000 0.0010T 0.0000	+0.030 +0.018 +0.0012 +0.0007	0.030T 0.005T 0.0012T 0.0002T	+0.051 +0.038 +0.0020 +0.0015	0.051T 0.025T 0.0020T 0.0010T	+0.102 +0.064 +0.0040 +0.0025	0.102T 0.051T 0.0040T 0.0020T	+0.038 +0.025 +0.0015 +0.0010	0.038T 0.012T 0.0015T 0.0005T
+0.038 +0.013 +0.0015 +0.0005	0.038T 0.012T 0.0015T 0.0005T	-	-	+0.076 +0.051 +0.0030 +0.0020	0.076T 0.026T 0.0030T 0.0010T	+0.102 +0.076 +0.0040 +0.0025	0.102T 0.051T 0.0040T 0.0020T	+0.064 +0.038 +0.0025 +0.0015	0.064T 0.013T 0.0025T 0.0005T

Housing Bore							
Stationary Outer Ring							
Rear Wheels	(Semi-Floating Axles)	Differential	(Split Seat)	Transmissions	Transfer Cases Cross Shafts	Pinion (Solid Seat) Transmission	Differential Transaxles Transfer Cases
Adjustable (TS) Clamped (TSU)		Adjustable		Adjustable		Non-adjustable	
Housing Bore Deviation	Resultant Fit	Housing Bore Deviation	Resultant Fit	Housing Bore Deviation	Resultant Fit	Housing Bore Deviation	Resultant Fit
mm in.	mm in.	mm in.	mm in.	mm in.	mm in.	mm in.	mm in.
+0.038 +0.076 +0.0015 +0.0030	0.013L 0.076L 0.0005L 0.0030L	+0.025 +0.051 +0.0010 +0.0020	0.000 0.051L 0.0000 0.0020L	0.000 +0.025 0.000 +0.0010	0.025T 0.025L 0.0010T 0.0010L	-0.038 -0.013 -0.0015 -0.0005	0.063T 0.013T 0.0025T 0.0005T
+0.038 +0.076 +0.0015 +0.0030	0.013L 0.076L 0.0005L 0.0030L	+0.025 +0.051 +0.0010 +0.0020	0.000 0.051L 0.0000 0.0020L	0.000 +0.025 0.0000 +0.0010	0.025T 0.025L 0.0010T 0.0010L	-0.051 -0.025 -0.0020 -0.0010	0.076T 0.025T 0.0030T 0.0010T
-	-	0.000 +0.051 0.0000 +0.0020	0.025T 0.051L 0.0010T 0.0020L	0.000 +0.051 0.0000 +0.0020	0.025T 0.051L 0.0010T 0.0020L	-0.077 -0.025 -0.0030 -0.0010	0.102T 0.025T 0.0040T 0.0010T

These charts are guidelines for specifying shaft and housing fits related to particular operating conditions. Please contact your Timken engineer for more information.

**INNER RING – Automotive Equipment
Classes K and N (Metric)**

TABLE 28. TAPERED ROLLER BEARINGS – INNER RING – Automotive Equipment Classes K and N (Metric)

Inner Ring Bore		Shaft O.D.										
		Tolerance		Stationary Inner Ring			Rotating Inner Ring					
				Front Wheels Rear Wheel (Full-Floating Axles) Trailer Wheels			Rear Wheels (Semi-Floating Axles)			Rear Wheels (Unit-Bearing) (Semi-Floating Axles)		
				Non-adjustable			Non-adjustable			Non-adjustable		
Over	Incl.	Shaft O.D. Deviation	Resultant Fit	Symbol	Shaft O.D. Deviation	Resultant Fit	Symbol	Shaft O.D. Deviation	Resultant Fit	Symbol		
mm in.	mm in.	mm in.	mm in.	mm in.	mm in.	mm in.	mm in.	mm in.	mm in.	mm in.		
18.000 0.7087	30.000 1.1811	-0.012	-0.020	0.008L	f6	+0.035	0.047T	p6	+0.035	0.047T	p6	
		0.000	-0.033	0.033L		+0.022	0.022T		+0.022	0.022T		
		-0.0005	-0.0008	0.0003L		+0.0013	0.0018T		+0.0013	0.0018T		
		0.0000	-0.0013	0.0013L		+0.0008	0.0008T		+0.0008	0.0008T		
30.000 1.1811	50.000 1.9685	-0.012	-0.025	0.013L	f6	+0.042	0.054T	p6	+0.042	0.054T	p6	
		0.000	-0.041	0.041L		+0.026	0.026T		+0.026	0.026T		
		-0.0005	-0.0010	0.0005L		+0.0016	0.0021T		+0.0016	0.0021T		
		0.0000	-0.0016	0.0016L		+0.0010	0.0010T		+0.0010	0.0010T		
50.000 1.9685	80.000 3.1496	-0.015	-0.030	0.015L	f6	+0.051	0.066T	p6	-	-	-	
		0.000	-0.049	0.049L		+0.032	0.032T		+0.032	0.032T		
		-0.0006	-0.0012	0.0006L		+0.0021	0.0027T		+0.0021	0.0027T		
		0.0000	-0.0019	0.0019L		+0.0014	0.0014T					
80.000 3.1496	120.000 4.7244	-0.020	-0.035	0.016L	f6	+0.045	0.065T	n6	-	-	-	
		0.000	-0.058	0.058L		+0.023	0.023T		+0.023	0.023T		
		-0.0008	-0.0014	0.0006L		+0.0019	0.0027T		+0.0019	0.0027T		
		0.0000	-0.0023	0.0023L		+0.0010	0.0010T					
120.000 4.7244	180.000 7.0866	-0.025	-0.043	0.018L	f6	+0.052	0.077T	n6	-	-	-	
		0.000	-0.068	0.068L		+0.027	0.029T		+0.027	0.029T		
		-0.0010	-0.0016	0.0006L		+0.0022	0.0032T		+0.0022	0.0032T		
		0.0000	-0.0026	0.0026L		+0.0012	0.0012T					

These charts are guidelines for specifying shaft and housing fits related to particular operating conditions. Please contact your Timken engineer for more information.

Shaft O.D.													
Rotating Inner Ring													
Pinion									Differential		Transaxles, Transmissions Transfer Cases, Cross Shafts		
Clamped			Collapsible Spacer			Non-adjustable			Non-adjustable		Non-adjustable		
Shaft O.D. Deviation	Resultant Fit	Symbol	Shaft O.D. Deviation	Resultant Fit	Symbol	Shaft O.D. Deviation	Resultant Fit	Symbol	Shaft O.D. Deviation	Resultant Fit	Shaft O.D. Deviation	Resultant Fit	Symbol
mm in.	mm in.		mm in.	mm in.		mm in.	mm in.		mm in.	mm in.	mm in.	mm in.	
+0.015 +0.002 +0.0006 +0.0001	0.027T 0.002T	k6	+0.015 +0.002 +0.0006 +0.0001	0.027T 0.002T	k6	+0.035 +0.022 +0.0013 +0.0009	0.047T 0.022T	p6	+0.056 +0.035 +0.0022 +0.0014	0.068T 0.035T	+0.021 +0.008 +0.0008 +0.0003	0.033T 0.008T	m6
+0.018 +0.002 +0.0007 +0.0001	0.030T 0.002T	k6	+0.018 +0.002 +0.0007 +0.0001	0.030T 0.002T	k6	+0.042 +0.026 +0.0016 +0.0010	0.054T 0.026T	p6	+0.068 +0.043 +0.0028 +0.0018	0.080T 0.043T	+0.025 +0.009 +0.0010 +0.0004	0.037T 0.009T	m6
+0.021 +0.002 +0.0008 -0.0001	0.036T 0.002T	k6	+0.021 +0.002 +0.0008 +0.0001	0.036T 0.002T	k6	+0.051 +0.032 +0.021 +0.014	0.066T 0.032T	p6	+0.0089 +0.059 +0.0034 +0.0022	0.104T 0.059T	+0.030 +0.011 +0.0012 +0.0004	0.045T 0.011T	m6
+0.013 -0.009 +0.0005 -0.0004	0.033T 0.009L	j6	-	-	-	+0.045 +0.023 +0.0019 +0.0010	0.065T 0.023T	n6	+0.114 +0.079 +0.0044 +0.0030	0.134T 0.079T	+0.035 +0.013 +0.0014 +0.0005	0.055T 0.013T	m6
+0.014 -0.011 +0.0006 -0.0004	0.039T 0.011L	j6	-	-	-	+0.052 +0.028 +0.0022 +0.0012	0.077T 0.029T	n6	+0.140 +0.100 +0.0056 +0.0040	0.165T 0.100T	+0.040 +0.015 +0.0016 +0.0006	0.066T 0.015T	-

FITTING PRACTICE TABLES

These charts are guidelines for specifying shaft and housing fits related to particular operating conditions. Please contact your Timken engineer for more information.

OUTER RING – Automotive Equipment
Classes K and N (Metric)

Deviation from nominal (maximum)
bearing bore and resultant fit.

T= Tight
L= Loose

TABLE 29. TAPERED ROLLER BEARINGS – OUTER RING – Automotive Equipment Classes K and N (Metric)

Outer Ring O.D.		Housing Bore																		
		Rotating Outer Ring			Stationary Outer Ring															
					Rear Wheels (Semi-Floating Axles)			Differential (Split Seat)			Transmissions Transfer Cases Cross Shafts			Pinion Differential (Solid Seat) Transaxles Transmission ⁽¹⁾ Transfer Cases						
		Non-adjustable			Adjustable (TS) Clamped (TSU)			Adjustable			Adjustable			Non-adjustable						
Over	Incl.	Tolerance			Housing Bore	Resultant	Symbol	Housing Bore	Resultant	Symbol	Housing Bore	Resultant	Symbol	Housing Bore	Resultant	Symbol	Housing Bore	Resultant	Symbol	
mm in.	mm in.	mm in.	mm in.	mm in.	mm in.	mm in.	mm in.	mm in.	mm in.	mm in.	mm in.	mm in.	mm in.	mm in.	mm in.	mm in.	mm in.	mm in.	mm in.	mm in.
30.000 1.1811	50.000 1.9685	0.000 -0.014 0.0000 -0.0006	-0.050 -0.025 -0.0020 -0.0010	0.050T 0.011T 0.0020T 0.0004T	R7	+0.009 +0.034 +0.0004 +0.0014	0.009L 0.048L 0.0004L 0.0020L	G7	0.000 +0.025 0.0000 +0.0010	0.000 0.039L 0.0000 0.0016L	H7	-0.013 +0.003 -0.0005 +0.0001	0.013T 0.017L 0.0005T 0.0007L	K6	-0.050 -0.025 -0.0020 -0.0010	0.050T 0.011T 0.0020T 0.0004T	R7			
50.000 1.9685	65.000 2.5591	0.000 -0.016 0.0000 -0.0006	-0.060 -0.030 -0.0023 -0.0011	0.060T 0.014T 0.0023T 0.0005T	R7	+0.010 +0.040 +0.0004 +0.0016	0.010L 0.056L 0.0004L 0.0022L	G7	0.000 +0.030 0.0000 +0.0012	0.000 0.046L 0.0000 0.0018L	H7	-0.015 +0.004 -0.0006 +0.0001	0.015T 0.020L 0.0006T 0.0007L	K6	-0.060 -0.030 -0.0023 -0.0011	0.060T 0.014T 0.0023T 0.0005T	R7			
65.000 2.5591	80.000 3.1496	0.000 -0.016 0.0000 -0.0006	-0.062 -0.032 -0.0023 -0.0011	0.062T 0.016T 0.0023T 0.0005T	R7	+0.012 +0.047 +0.0005 +0.0029	0.012L 0.065L 0.0005L 0.0026L	G7	0.000 +0.035 0.0000 +0.0014	0.000 0.053L 0.0000 0.0021L	H7	-0.018 +0.004 -0.0007 +0.0002	0.018T 0.022L 0.0007T 0.0009L	K6	-0.073 -0.038 -0.0029 -0.0015	0.073T 0.020T 0.0029T 0.0008T	R7			
80.000 3.1496	100.000 3.9370	0.000 -0.018 0.0000 -0.0007	-0.073 -0.038 -0.0029 -0.0015	0.073T 0.020T 0.0029T 0.0008T	R7	+0.014 +0.054 +0.0006 +0.0022	0.014L 0.074L 0.0006L 0.0030L	G7	-0.014 +0.026 -0.0006 +0.0010	0.014T 0.046L 0.0006L 0.0018L	J7	-0.021 +0.004 -0.0008 +0.0002	0.021T 0.024L 0.0008T 0.0010L	K6	-0.088 -0.048 -0.0035 -0.0019	0.088T 0.028T 0.0035T 0.0011T	R7			
100.000 3.9370	120.000 4.7244	0.000 -0.018 0.0000 -0.0007	-0.076 -0.041 -0.0029 -0.0015	0.076T 0.023T 0.0029T 0.0008T	R7	+0.014 +0.054 +0.0006 +0.0022	0.014L 0.074L 0.0006L 0.0030L	G7	-0.014 +0.026 -0.0006 +0.0010	0.014T 0.046L 0.0006L 0.0018L	J7	-0.021 +0.004 -0.0008 +0.0002	0.021T 0.024L 0.0008T 0.0010L	K6	-0.090 -0.050 -0.0035 -0.0019	0.090T 0.030T 0.0035T 0.0011T	R7			
120.000 4.7244	140.000 5.5118	0.000 -0.020 0.0000 -0.0008	-0.088 -0.048 -0.0035 -0.0019	0.088T 0.028T 0.0035T 0.0011T	R7	+0.014 +0.054 +0.0006 +0.0022	0.014L 0.074L 0.0006L 0.0030L	G7	-0.014 +0.026 -0.0006 +0.0010	0.014T 0.046L 0.0006L 0.0018L	J7	-0.021 +0.004 -0.0008 +0.0002	0.021T 0.024L 0.0008T 0.0010L	K6	-0.090 -0.050 -0.0035 -0.0019	0.090T 0.025T 0.0035T 0.0009T	R7			
140.000 5.5118	150.000 5.9055	0.000 -0.020 0.0000 -0.0008	-0.090 -0.050 -0.0035 -0.0019	0.090T 0.030T 0.0035T 0.0011T	R7	+0.014 +0.054 +0.0006 +0.0022	0.014L 0.074L 0.0006L 0.0030L	G7	-0.014 +0.026 -0.0006 +0.0010	0.014T 0.046L 0.0006L 0.0018L	J7	-0.021 +0.004 -0.0008 +0.0002	0.021T 0.029L 0.0008T 0.0012L	K6	-0.093 -0.053 -0.0035 -0.0019	0.093T 0.028T 0.0035T 0.0009T	R7			
150.000 5.9055	160.000 6.2992	0.000 -0.025 0.0000 -0.0010	-0.090 -0.050 -0.0035 -0.0019	0.090T 0.025T 0.0035T 0.0009T	R7	+0.014 +0.054 +0.0006 +0.0022	0.014L 0.074L 0.0006L 0.0030L	G7	-0.014 +0.026 -0.0006 +0.0010	0.014T 0.046L 0.0006L 0.0018L	J7	-0.021 +0.004 -0.0008 +0.0002	0.021T 0.029L 0.0008T 0.0012L	K6	-0.093 -0.053 -0.0035 -0.0019	0.093T 0.028T 0.0035T 0.0009T	R7			
160.000 6.2992	180.000 7.0866	0.000 -0.025 0.0000 -0.0010	-0.093 -0.053 -0.0035 -0.0019	0.093T 0.028T 0.0035T 0.0009T	R7	+0.014 +0.054 +0.0006 +0.0022	0.014L 0.074L 0.0006L 0.0030L	G7	-0.014 +0.026 -0.0006 +0.0010	0.014T 0.046L 0.0006L 0.0018L	J7	-0.021 +0.004 -0.0008 +0.0002	0.021T 0.029L 0.0008T 0.0012L	K6	-0.093 -0.053 -0.0035 -0.0019	0.093T 0.028T 0.0035T 0.0009T	R7			

⁽¹⁾Aluminum housings min. fit of 0.025 mm (0.001 in.) per inch of outer ring O.D. Magnesium housing min. fit of 0.038 mm (0.0015 in.) per inch of outer ring O.D.

Continued on next page.

These charts are guidelines for specifying shaft and housing fits related to particular operating conditions. Please contact your Timken engineer for more information.

Table 29 continued.

Outer Ring O.D.		Housing Bore																		
		Rotating Outer Ring			Stationary Outer Ring															
					Rear Wheels (Semi-Floating Axles)			Differential (Split Seat)			Transmissions Transfer Cases Cross Shafts			Pinion Differential (Solid Seat) Transaxles Transmission ⁽¹⁾ Transfer Cases						
		Non-adjustable			Adjustable (TS) Clamped (TSU)			Adjustable			Adjustable			Non-adjustable						
Over	Incl.	Tolerance			Housing Bore Deviation	Resultant Fit	Symbol	Housing Bore Deviation	Resultant Fit	Symbol	Housing Bore Deviation	Resultant Fit	Symbol	Housing Bore Deviation	Resultant Fit	Symbol	Housing Bore Deviation	Resultant Fit	Symbol	
mm in.	mm in.	mm in.	mm in.	mm in.	mm in.	mm in.	mm in.	mm in.	mm in.	mm in.	mm in.	mm in.	mm in.	mm in.	mm in.	mm in.	mm in.	mm in.	mm in.	
180.000 7.0866	200.000 7.8740	0.000 -0.030 0.0000 -0.0012	-0.106 -0.060 -0.0042 -0.0024	0.106T 0.030T 0.0042T 0.0012T																
200.000 7.8740	225.000 8.8583	0.000 -0.030 0.0000 -0.0012	-0.109 -0.063 -0.0042 -0.0024	0.109T 0.033T 0.0042T 0.0012T	R7	-	-	-	-0.016 +0.030 -0.0007 +0.0011	0.016T 0.060L 0.0007T 0.0023L	J7	-0.016 +0.030 -0.0007 +0.0011	0.016T 0.060L 0.0007T 0.0023L	J7	-0.109 -0.063 -0.0042 -0.0024	0.109T 0.033T 0.0042T 0.0012T	R7			
225.000 8.8583	250.000 9.8425	0.000 -0.030 0.0000 -0.0012	-0.113 -0.067 -0.0042 -0.0024	0.113T 0.037T 0.0042T 0.0012T																
250.000 9.8425	280.000 11.0236	0.000 -0.035 0.0000 -0.0014	-0.126 -0.074 -0.0047 -0.0027	0.126T 0.039T 0.0047T 0.0013T	R7	-	-	-	-0.016 +0.036 -0.0007 +0.0013	0.016T 0.071L 0.0007T 0.0027L	J7	-0.016 +0.036 -0.0007 +0.0014	0.016T 0.071L 0.0007T 0.0027L	J7	-0.126 -0.074 -0.0047 -0.0027	0.126T 0.039T 0.0047T 0.0013T	R7			
280.000 11.0236	315.000 12.4016	0.000 -0.035 0.0000 -0.0014	-0.130 -0.078 -0.0047 -0.0027	0.130T 0.043T 0.0047T 0.0013T																

⁽¹⁾Aluminum housings min. fit of 0.025 mm (0.001 in.) per inch of outer ring O.D. Magnesium housing min. fit of 0.038 mm (0.0015 in.) per inch of outer ring O.D.

FITTING PRACTICE TABLES

These charts are guidelines for specifying shaft and housing fits related to particular operating conditions. Please contact your Timken engineer for more information.

THRUST TAPERED ROLLER BEARINGS

Tolerances for housing bore and shaft diameters are shown as variance from nominal bearing dimension. When one ring is piloted by the housing, sufficient clearances must be allowed at the outside diameter of the other ring as well as at the bore of both rings to prevent cross-loading of the rollers. For most applications, this clearance is approximately 1/16 in. (1.588 mm, 0.0625 in.).

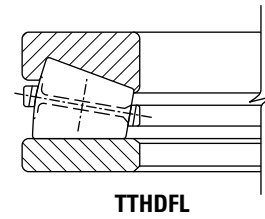
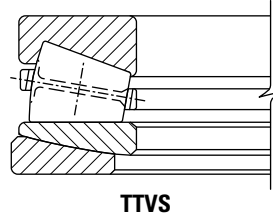


TABLE 30. THRUST TAPERED ROLLER BEARINGS TYPE TTVS AND TTHDFL – SHAFT DIAMETERS

Bearing Bore Nominal (Min.)		Shaft Diameter
Over	Incl.	Min. ⁽¹⁾
mm in.	mm in.	mm in.
0.000 0.0000	304.800 12.0000	-0.051 -0.0020
304.800 12.0000	508.000 20.0000	-0.051 -0.0020
508.000 20.0000	711.200 28.0000	-0.076 -0.0030
711.200 28.0000	1219.200 48.0000	-0.102 -0.0040
1219.200 48.0000	1727.200 68.0000	-0.127 -0.0050

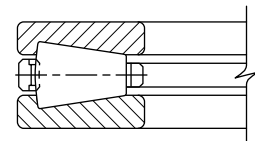
⁽¹⁾Tolerance range is from +0 to value listed.

TABLE 31. THRUST TAPERED ROLLER BEARINGS TYPE TTVS AND TTHDFL – HOUSING DIAMETERS

Bearing Bore Nominal (Min.)		Housing Bore	
Over	Incl.	Max.	Min.
mm in.	mm in.	mm in.	mm in.
161.925 6.3750	265.113 10.4375	+0.060 +0.0025	+0.025 +0.0010
265.113 10.3475	317.500 12.5000	+0.076 +0.0030	+0.025 +0.0010
317.500 12.5000	482.600 19.0000	+0.102 +0.0040	+0.051 +0.0020
482.600 19.0000	603.250 23.7500	+0.113 +0.0045	+0.051 +0.0020
603.250 23.7500	711.200 28.0000	+0.152 +0.0060	+0.076 +0.0030
711.200 28.0000	838.200 33.0000	+0.178 +0.0070	+0.076 +0.0030

TABLE 32. THRUST TAPERED ROLLER BEARINGS – TTHD BEARINGS – FITTING GUIDELINES

Bore		Rotating Ring						Stationary Ring
		Tolerance	Class 2 Shaft O.D. Deviation	Resultant Fit	Tolerance	Class 3 Shaft O.D. Deviation	Resultant Fit	Class 2 and 3
Over	Incl.	mm in.	mm in.	mm in.	mm in.	mm in.	mm in.	
0.000 0.0000	304.800 12.0000	0.000 +0.025 0.0000 +0.0010	+0.076 +0.050 +0.0030 +0.0020	0.076T 0.025T 0.0030T 0.0010T	0.000 +0.013 0.0000 +0.0005	+0.051 +0.038 +0.0020 +0.0015	0.051T 0.025T 0.0020T 0.0010T	All sizes
304.800 12.0000	609.600 24.0000	0.000 +0.051 0.0000 +0.0020	+0.152 +0.102 +0.0060 +0.0040	0.152T 0.051T 0.0060T 0.0020T	0.000 +0.025 0.0000 +0.0010	+0.102 +0.076 +0.0040 +0.0030	0.102T 0.051T 0.0040T 0.0020T	
609.600 24.0000	914.400 36.0000	0.000 +0.076 0.0000 +0.0030	+0.204 +0.127 +0.0080 +0.0050	0.204T 0.051T 0.0080T 0.0020T	0.000 +0.038 0.0000 +0.0015	+0.127 +0.089 +0.0050 +0.0035	0.127T 0.051T 0.0050T 0.0020T	
914.400 36.0000	1219.200 48.0000	0.000 +0.102 0.0000 +0.0040	+0.254 +0.153 +0.0100 +0.0060	0.254T 0.051T 0.0100T 0.0020T	0.000 +0.051 0.0000 +0.0020	+0.153 +0.102 +0.0060 +0.0040	0.153T 0.051T 0.0060T 0.0020T	
1219.200 48.0000		0.000 +0.127 0.0000 +0.0050	+0.305 +0.178 +0.0120 +0.0070	0.305T 0.051T 0.0120T 0.0020T	0.000 +0.076 0.0000 +0.0030	+0.204 +0.127 +0.0080 +0.0050	0.204T 0.051T 0.0080T 0.0020T	



TTHD

- Rotating ring O.D. must have a minimum radial clearance of 2.5 mm (0.1 in.).
 - TTHD stationary ring O.D. must have a minimum loose fit of 0.25 to 0.37 mm (0.01 to 0.015 in.).
 - TTHDFL ring when stationary may be loose fit on its O.D. (same as the TTHD) or may be 0.025 to 0.076 mm (0.001 to 0.003 in.) tight.
- Provide a minimum radial clearance of 2.5 mm (0.1 in.) between ring bore and shaft O.D.

OPERATING TEMPERATURES

Bearings operate in a wide range of applications and environments. In most cases, bearing operating temperature is not an issue. Some applications, however, operate at extreme speeds or in extreme temperature environments. In these cases, care must be taken not to exceed the temperature limits of the bearing. Minimum temperature limits are primarily based on lubricant capability. Maximum temperature limits are most often based on material and/or lubricant constraints, but also may be based on accuracy requirements of the equipment that the bearings are built into. These constraints/limitations are discussed below.

BEARING MATERIAL LIMITATIONS

Standard bearing steels with a standard heat treatment cannot maintain a minimum hardness of 58 HRC much above 120° C (250° F).

Dimensional stability of Timken bearings is managed through the proper selection of an appropriate heat-treat process. Standard Timken tapered roller and ball bearings are dimensionally stabilized from -54° C (-65° F) up to 120° C (250° F), while standard spherical roller bearings are dimensionally stabilized up to 200° C (392° F) and standard cylindrical roller bearings are stabilized up to 150° C (302° F). Upon request, these bearings can be ordered to higher levels of stability as listed below. These designations are in agreement with DIN Standard 623.

TABLE 33.

Stability Designation	Maximum Operating Temperature	
	°C	°F
S0	150	302
S1	200	392
S2	250	482
S3	300	572
S4	350	662

With dimensionally stabilized product, there still may be some changes in dimensions during service as a result of microstructural transformations. These transformations include the continued tempering of martensite and decomposition of retained austenite. The magnitude of change depends on the operating temperature, the time at temperature and the composition and heat-treatment of the steel.

Temperatures exceeding the limits shown in table 33 require special high-temperature steel. Consult your Timken engineer for availability of specific part numbers for non-standard heat stability or high-temperature steel grades.

Suggested materials for use in balls, rings and rollers at various operating temperatures are listed in table 34. Also listed are chemical composition recommendations, hardness recommendations and dimensional stability information.

Operating temperature affects lubricant film thickness and setting, both of which directly influence bearing life. Extremely high temperatures can result in a reduced film thickness that can lead to asperity contact between contacting surfaces.

Operating temperature also can affect performance of cages, seals and shields, which in turn can affect bearing performance. Materials for these components and their operating temperature ranges are shown in table 35.

LUBRICATION LIMITATIONS

Starting torque in grease-lubricated applications typically increases significantly at cold temperatures. Starting torque is not primarily a function of the consistency or channel properties of the grease. Most often, it is a function of the rheological properties of the grease.

The high-temperature limit for greases is generally a function of the thermal and oxidation stability of the base oil in the grease and the effectiveness of the oxidation inhibitors.

See the LUBRICATION AND SEALS section on page 61 for more information on lubrication limitations.

EQUIPMENT REQUIREMENTS

The equipment designer must evaluate the effects of temperature on the performance of the equipment being designed. Precision machine tool spindles, for example, can be very sensitive to thermal expansions. For some spindles, it is important that the temperature rise over ambient be held to 20° C to 35° C (36° F to 45° F).

Most industrial equipment can operate at considerably higher temperatures. Thermal ratings on gear drives, for example, are based on 93° C (200° F). Equipment such as gas turbines operates continuously at temperatures above 100° C (212° F). Running at high temperatures for extended periods of time, however, may affect shaft and housing fits, if the shaft and housing are not machined and heat-treated properly.

OPERATING TEMPERATURES

Although bearings can operate satisfactorily up to 120° C (250° F), an upper temperature limit of 80° C to 95° C (176° F to 203° F) is more practical. Higher operating temperatures increase the risk of damage from transient temperature spikes. Prototype testing of the application can help define the operating temperature range and should be conducted if possible. It is the responsibility of the equipment designer to weigh all relevant factors and make the final determination of satisfactory operating temperature.

Tables 34 and 35 provide standard operating temperatures for common bearing component materials. They should be used for reference purposes only. Other bearing component materials are available on request. Contact your Timken engineer for more information.

TABLE 34. OPERATING TEMPERATURES FOR BEARING COMPONENT MATERIALS

Material	Approximate Chemical Analysis %	Temp. °F	Hardness HRC	-73° C	-54° C	-17° C	38° C	93° C	121° C	149° C	204° C	260° C	316° C	371° C	427° C
				-100° F	-65° F	0° F	100° F	200° F	250° F	300° F	400° F	500° F	600° F	700° F	800° F
Low-alloy carbon-chromium bearing steels. 52100 and others per ASTM A295	1C 0.5–1.5Cr 0.35Mn	70	60	STANDARD DIMENSIONAL STABILIZATION <0.0001 in./in dimensional change in 2500 hours at 100° C (212° F). Good oxidation resistance.											
Low-alloy carbon-chromium bearing steels. 52100 and others per ASTM A295	1C 0.5–1.5Cr 0.35Mn	70 350 450	58 56 54	Heat stabilized per FS136, <0.0001 in./in dimensional change in 2500 hours at 149° C (300° F). When given a stabilizing heat treatment, A295 steel is suitable for many applications in the 177°–232° C (350–450° F) range; however, it is not as dimensionally stable as it is at temperatures below 177° C (350° F). If utmost stability is required, use materials in the 316° C (600° F) group below.											
Deep-hardening steels for heavy sections per ASTM A485	1C 1–1.8Cr 1–1.5Mn .06Si	70 450 600	58 55 52	As heat-treated and tempered, it is stabilized, <0.0001 in./in dimensional change in 2500 hours at 149° C (300° F).											
Carburizing steels per ASTM A534 a) low alloy 4118, 8X19, 5019, 8620 (Ni-Moly grades) b) high nickel 3310	Ni-Moly: 0.2C, 0.4–2.0Mn, 0.3–0.8Cr, 0–2.0Ni, 0–0.3Mo .01C, 1.5Cr, 0.4Mn, 3.5Ni	70	58	Nickel-Moly grades of steel frequently used to achieve extra ductility in inner rings for locking device bearings. 3311 and others used for extra-thick-section rings.											
Corrosion-resistant 440C stainless steel per ASTM A756	1C 18Cr	70	58	Excellent corrosion resistance.											
Corrosion-resistant 440C stainless steel per ASTM A756	1C 18Cr	70 450 600	58 55 52	As heat stabilized for maximum hardness at high temperatures (FS238). Good oxidation resistance at higher temperatures. Note load capacity drops off more rapidly at higher temperatures than M50 shown below, which should be considered if loads are high, <0.0001 in./in dimensional change in 1200 hours.											
M-50 medium high speed	4Cr 4Mo 1V 0.8C	70 450 600	60 59 57	Suggested where stable high hardness at elevated temperature is required, <0.0001 in./in dimensional change in 1200 hours at 316° C (600° F).											

Note: Dimensional stability data shown above is the permanent metallurgical growth and/or shrinkage only. Thermal expansion effects are not included. For operating temperatures above 427° C (800° F), consult your Timken engineer.

TABLE 35. OPERATING TEMPERATURES FOR BEARING COMPONENT MATERIALS

	-54° C -65° F	-17° C 0° F	38° C 100° F	93° C 200° F	149° C 300° F	204° C 400° F	260° C 500° F	316° C 600° F	371° C 700° F	427° C 800° F
CAGES										
Molded 6/6 nylon (PRB)										
Molded 6/6 fiberglass reinforced nylon (PRC)										
Phenolic resin laminate										
Low-carbon pressed steel										
Pressed stainless steel										
Machined bronze										
Machined iron-silicon bronze										
Machined steel										
SHIELDS										
Low-carbon steel										
Stainless steel										
Nylon										
SEALS										
Buna N										
Polyacrylic										
Fluoroelastomer										
Stabilized TFE fluorocarbon ⁽¹⁾										
TFE fluorocarbon ⁽¹⁾ (with glass fabric)										

⁽¹⁾Limited life above these temperatures.

HEAT GENERATION AND DISSIPATION

Bearing operating temperature is dependent upon a number of factors, including heat generation of all contributing heat sources, heat flow rate between sources and the ability of the system to dissipate the heat. Heat sources include such things as bearings, seals, gears, clutches and oil supply. Heat dissipation is affected by many factors, including shaft and housing materials and designs, lubricant circulation and external environmental conditions. These and other factors are discussed in the following sections.

HEAT GENERATION

Under normal operating conditions, most of the torque and heat generated by the bearing is caused by the elastohydrodynamic losses at the roller/ring contacts.

Heat generation is the product of bearing torque and speed. The following equation is used to calculate the heat generated.

$$Q_{\text{gen}} = k_4 n M$$

If the bearing is tapered, the torque can be calculated using the following equation.

$$M = k_1 G_1 (n\mu)^{0.62} (P_{\text{eq}})^{0.3}$$

Where:

- k_1 = bearing torque constant
= 2.56×10^{-6} for M in N-m
= 3.54×10^{-5} for M in lbf-in.
- k_4 = 0.105 for Q_{gen} in W when M in N-m
= 6.73×10^{-4} for Q_{gen} in Btu/min when M in lbf-in.

HEAT DISSIPATION

The problem of determining the heat flow from a bearing in a specific application is rather complex. In general, it can be said that factors affecting the rate of heat dissipation include the following:

1. Temperature gradient from the bearing to the housing. This is affected by size configuration of the house and any external cooling such as fans, water cooling or fan action of the rotating components.
2. Temperature gradient from the bearing to the shaft. Any other heat sources, such as gears and additional bearings and their proximity to the bearing considered, will influence the temperature of the shaft.
3. The heat carried away by a circulating oil system.

To what extent nos. 1 and 2 can be controlled will depend on the application. The heat-dissipation modes include conduction through the system, convection along the inside and outside surfaces of the system, as well as radiation exchange to and from neighboring structures. In many applications, overall heat dissipation can be divided into two categories – heat removed by circulating oil and heat removed through the structure.

Heat dissipation by circulating oil

The amount of heat removed by the lubricant can be controlled more easily. In a splash lubrication system, cooling coils may be used to control the bulk oil temperature.

The amount of heat carried away in a circulating oil system by the lubricant can be approximated from the following equations.

$$Q_{\text{oil}} = k_6 C_p \rho f (\theta_o - \theta_i)$$

Where:

- k_6 = 1.67×10^{-5} for Q_{oil} in W
= 1.67×10^{-2} for Q_{oil} in Btu/min

If the circulating lubricant is petroleum oil, the heat removed is further approximated by the following:

$$Q_{\text{oil}} = k_5 f (\theta_o - \theta_i)$$

The following factors apply to the heat generation and dissipation equations listed on this page.

Where:

- k_5 = 28 for Q_{oil} in W when f in L/min and θ in °C
= 0.42 for Q_{oil} in Btu/min when f in U.S. pt/min and θ in °F

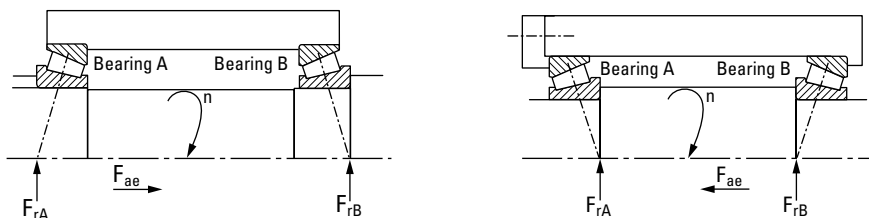
TORQUE

TAPERED ROLLER BEARINGS

RUNNING TORQUE-M

The rotational resistance of a rolling bearing depends on load, speed, lubrication conditions and internal bearing characteristics.

The following formulas yield approximations to values of bearing running torque. The formulas apply to bearings lubricated by oil. For bearings lubricated by grease or oil mist, torque is usually lower, although for grease lubrication this depends on amount and consistency of the grease. The formulas also assume the bearing running torque has stabilized after an initial period referred to as running-in.



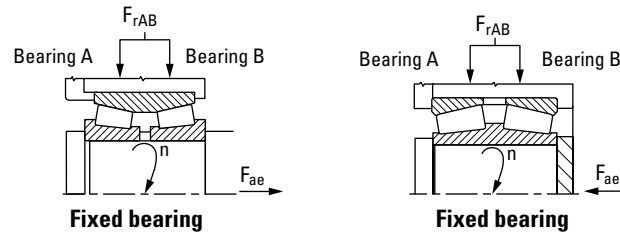
Design (external thrust, F_{ae} , onto bearing A)

Fig. 17. Single-row tapered roller bearing.

TABLE 36. VALUE APPROXIMATIONS OF BEARING RUNNING TORQUE

Thrust Condition	Net Bearing Thrust Load	
$\frac{0.47 F_{rA}}{K_A} \leq \frac{0.47 F_{rB}}{K_B} + F_{ae}$	$F_{aA} = \frac{0.47 F_{rB}}{K_B} + F_{ae}$ $F_{aB} = \frac{0.47 F_{rB}}{K_B}$	$M = k_1 G_1 (n\mu)^{0.62} \left(\frac{f_3 F_r}{K} \right)^{0.3}$ $n_{min} = \frac{k_2}{G_2 \mu} \left(\frac{f_2 F_r}{K} \right)^{2/3}$
$\frac{0.47 F_{rA}}{K_A} > \frac{0.47 F_{rB}}{K_B} + F_{ae}$	$F_{aA} = \frac{0.47 F_{rA}}{K_A}$ $F_{aB} = \frac{0.47 F_{rA}}{K_A} - F_{ae}$	

The torque equations will be underestimated if operating speed, n , is less than n_{min} . For values of f_1 and f_2 , refer to fig. 20 on page 59.



Design (external thrust, F_{ae} , onto bearing A)

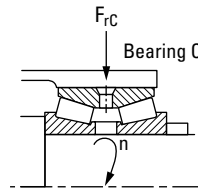
Fig. 18. Double-row tapered roller bearing.

TABLE 37. FIXED POSITION

Load Condition	Radial Load on Each Row F_r	
$F_{ae} > \frac{0.47 F_{rAB}}{K_A}$	Bearing B is unloaded $F_{rA} = F_{rAB}$ $F_{aA} = F_{ae}$	$M = k_1 G_1 (n\mu)^{0.62} \left(\frac{f_3 F_{rAB}}{K} \right)^{0.3}$ $n_{min} = \frac{k_2}{G_2\mu} \left(\frac{f_2 F_{rAB}}{K} \right)^{2/3}$
$F_{ae} \leq \frac{0.47 F_{rAB}}{K_A}$	$F_{rA} = \frac{F_{rAB}}{2} + 1.06 K F_{ae}$ $F_{rB} = \frac{F_{rAB}}{2} - 1.06 K F_{ae}$	$M = k_1 G_1 (n\mu)^{0.62} \left(\frac{0.060}{K} \right)^{0.3} (F_{rA}^{0.3} + F_{rB}^{0.3})$ $n_{minA} = \frac{k_2}{G_2\mu} \left(\frac{1.78 F_{rA}}{K} \right)^{2/3}; \quad n_{minB} = \frac{k_2}{G_2\mu} \left(\frac{1.78 F_{rB}}{K} \right)^{2/3}$

$$M = 2 k_1 G_1 (n\mu)^{0.62} \left(\frac{0.030 F_{rC}}{K} \right)^{0.3}$$

$$n_{min} = \frac{k_2}{G_2\mu} \left(\frac{0.890 F_r}{K} \right)^{2/3}$$



Floating bearing

The torque equations will be underestimated if operating speed, n , is less than n_{min} .
For values of f_1 and f_2 , refer to fig. 20 on page 59.

Fig. 19. Floating position.

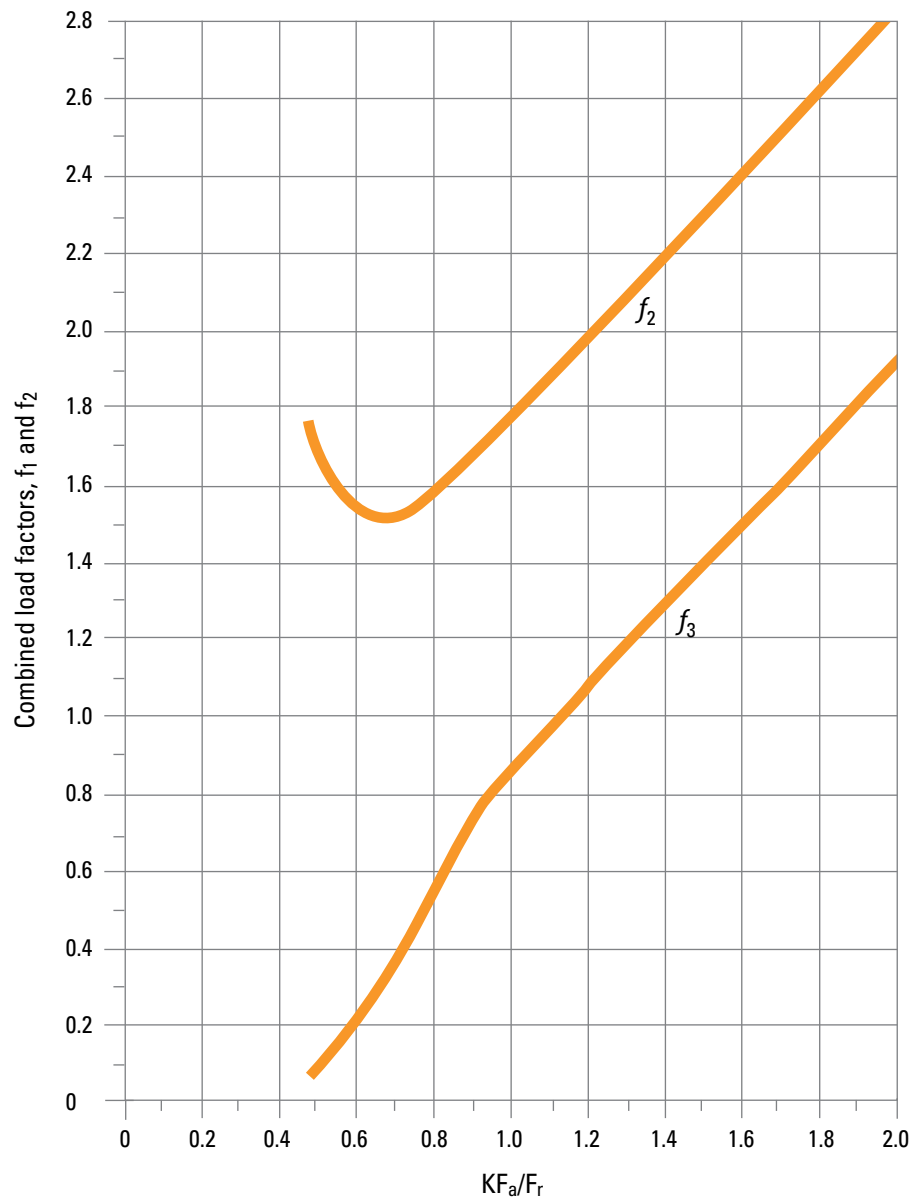
$k_1 = 2.56 \times 10^{-6}$ (metric) or 3.54×10^{-5} (inch)

$k_2 = 625$ (metric) or 1700 (inch)

μ = lubricant dynamic viscosity at operating temperature centipoise
For grease, use the base oil viscosity.

f_3 = combined load factor, see fig. 20 on page 59

f_2 = combined load factor, see fig. 20 on page 59



Load Condition	f_3 and f_2
$KF_a/F_r > 2.0$	$f_3 = KF_a/F_r$ $f_2 = f_3 + 0.8$
$0.47 \leq KF_a/F_r \leq 2.0$	Use graph above
$KF_a/F_r < 0.47$	$f_3 = 0.06$ $f_2 = 1.78$

Fig. 20. Determination of combined load factors f_3 and f_2 .

LUBRICATION

To help maintain a bearing's antifriction characteristics, lubrication is needed to:

- Minimize rolling resistance due to deformation of the rolling elements and raceway under load by separating the mating surfaces.
- Minimize sliding friction occurring between rolling elements, raceways and cage.
- Transfer heat (with oil lubrication).
- Protect from corrosion and, with grease lubrication, from contaminant ingress.



LUBRICATION

The wide range of bearing types and operating conditions precludes any simple, all-inclusive statement or guideline allowing the selection of the proper lubricant. At the design level, the first consideration is whether oil or grease is best for the particular operation. The advantages of oil and grease are outlined in the table below. When heat must be carried away from the bearing, oil must be used. It is almost always preferred for very high-speed applications.

TABLE 38. ADVANTAGES OF OIL AND GREASE

Oil	Grease
Carries heat away from the bearings	Simplifies seal design and acts as a sealant
Carries away moisture and particulate matter	Permits prelubrication of sealed or shielded bearings
Easily controlled lubrication	Generally requires less frequent lubrication

European REACH compliance

Timken-branded lubricants, greases and similar products sold in stand-alone containers or delivery systems are subject to the European REACH (**R**egistration, **E**valuation, **A**uthorization and **R**estriction of **C**hemicals) directive. For import into the European Union, Timken can sell and provide only those lubricants and greases that are registered with ECHA (**E**uropean **C**hemical **A**gency). For further information, please contact your Timken engineer.

OIL LUBRICATION

Oils used for bearing lubrication should be high-quality mineral oils or synthetic oils with similar properties. Selection of the proper type of oils depends on bearing speed, load, operating temperature and lubrication method. Some features and advantages of oil lubrication, in addition to the above are:

- Oil is a better lubricant for high speeds or high temperatures. It can be cooled to help reduce bearing temperature.
- It is easier to handle and control the amount of lubricant reaching the bearing. It is harder to retain in the bearing. Lubricant losses may be higher than with grease.
- Oil can be introduced to the bearing in many ways, such as drip-feed, wick-feed, pressurized circulating systems, oil bath or air-oil mist. Each is suited for certain types of applications.
- Oil is easier to keep clean for recirculating systems.

Oil may be introduced to the bearing housing in many ways. The most common systems are:

- **Oil bath.** The housing is designed to provide a sump through which the rolling elements of the bearing will pass. Generally, the oil level should be no higher than the center

point of the lowest rolling element. If speed is high, lower oil levels should be used to reduce churning. Gages or controlled elevation drains are used to achieve and maintain the proper oil level.

- **Circulating system.** This system has the advantages of:
 - An adequate supply of oil for both cooling and lubrication.
 - Metered control of the quantity of oil delivered to each bearing.
 - Removal of contaminants and moisture from the bearing by flushing action.
 - Suitability for multiple bearing installations.
 - Large reservoir, which reduces deterioration. Increased lubricant life provides economical efficiency.
 - Incorporation of oil-filtering devices.
 - Positive control to deliver the lubricant where needed.
 - A typical circulating oil system consists of an oil reservoir, pump, piping and filter. A heat exchange may be required.
- **Oil-mist lubrication.** Oil-mist lubrication systems are used in high-speed, continuous-operation applications. This system permits close control of the amount of lubricant reaching the bearings. The oil may be metered, atomized by compressed air and mixed with air, or it may be picked up from a reservoir using a venturi effect. In either case, the air is filtered and supplied under sufficient pressure to assure adequate lubrication of the bearings. Control of this type of lubrication system is accomplished by monitoring the operating temperatures of the bearings being lubricated. The continuous passage of the pressurized air and oil through the labyrinth seals used in the system prevents the entrance of contaminants from the atmosphere to the system.

The successful operation of this type of system is based upon the following factors:

 - Proper location of the lubricant entry ports in relation to the bearings being lubricated.
 - Avoidance of excessive pressure drops across void spaces within the system.
 - Proper air pressure and oil quantity ratio to suit the particular application.
 - Adequate exhaust of the air-oil mist after lubrication has been accomplished.

To ensure “wetting” of the bearings, and to prevent possible damage to the rolling elements and rings, it is imperative that the oil-mist system be turned on for several minutes before the equipment is started. The importance of “wetting” the bearing before starting cannot be overstated, and it also has particular significance for equipment that has been idled for extended periods of time.

Lubricating oils are commercially available in many forms for automotive, industrial, aircraft and other uses. Oils are classified as either petroleum types (refined from crude oil) or synthetic types (produced by chemical synthesis).

PETROLEUM OILS

Petroleum oils are made from a petroleum hydrocarbon derived from crude oil, with additives to improve certain properties. Petroleum oils are used for nearly all oil-lubricated applications of bearings.

SYNTHETIC OILS

Synthetic oils cover a broad range of categories and include polyalphaolefins, silicones, polyglycols and various esters. In general, synthetic oils are less prone to oxidation and can operate at extreme hot or cold temperatures. Physical properties, such as pressure-viscosity coefficients, tend to vary between oil types; use caution when making oil selections.

The polyalphaolefins (PAO) have a hydrocarbon chemistry that parallels petroleum oil both in chemical structures and pressure-viscosity coefficients. Therefore, PAO oil is mostly used in the oil-lubricated applications of bearings when severe temperature environments (hot and cold) are encountered or when extended lubricant life is required.

The silicone, ester and polyglycol oils have an oxygen-based chemistry that is structurally quite different from petroleum oils and PAO oils. This difference has a profound effect on its physical properties where pressure-viscosity coefficients can be lower compared to mineral and PAO oils. This means that these types of synthetic oils may actually generate a smaller elastohydrodynamic (EHD) film thickness than a mineral or PAO oil of equal viscosity at operating temperature. Reductions in bearing fatigue life and increases in bearing wear could result from this reduction of lubricant film thickness.

VISCOSITY

The selection of oil viscosity for any bearing application requires consideration of several factors: load, speed, bearing setting, type of oil and environmental factors. Since oil viscosity varies inversely with temperature, a viscosity value must always be stated with the temperature at which it was determined. High-viscosity oil is used for low-speed or high-ambient-temperature applications. Low-viscosity oil is used for high-speed or low-ambient-temperature applications.

There are several classifications of oils based on viscosity grades. The most familiar are the Society of Automotive Engineers (SAE) classifications for automotive engine and gear oils. The American Society for Testing and Materials (ASTM) and the International Organization for Standardization (ISO) have adopted standard viscosity grades for industrial fluids. Fig. 21 shows the viscosity comparisons of ISO/ASTM with SAE classification systems at 40° C (104° F).

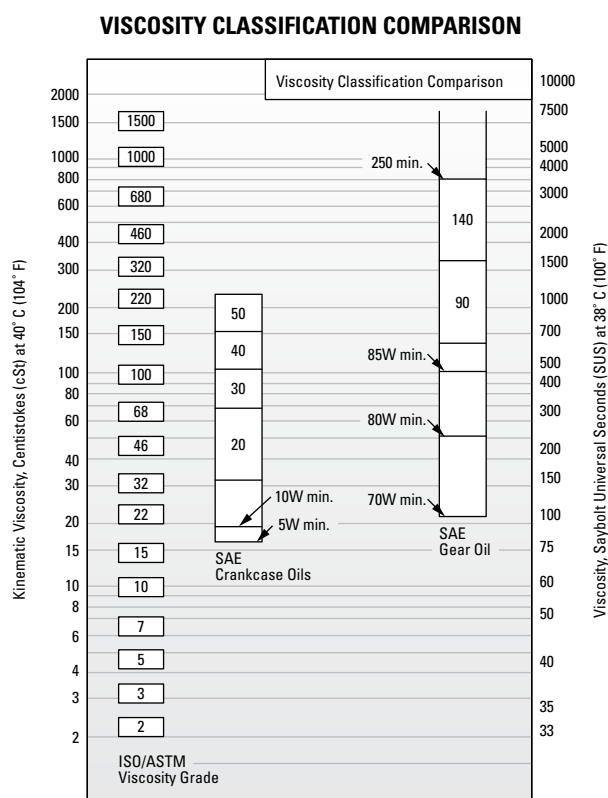


Fig. 21. Comparison between ISO/ASTM grades (ISO 3448/ASTM D2442) and SAE grades (SAE J 300-80 for crankcase oils, SAE J 306-81 for axle and manual transmission oils).

The ASTM/ISO viscosity grade system for industrial oils is depicted below.

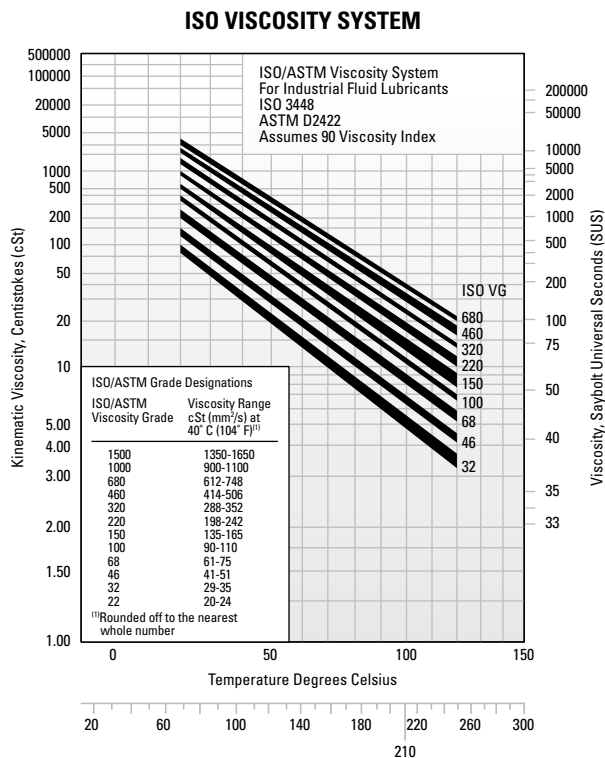


Fig. 22. Viscosity grade system for industrial oils.

TYPICAL BEARING LUBRICATION OILS

In this section, the properties and characteristics of lubricants for typical roller bearing applications are listed. These general characteristics are derived from successful performance in applications across all industries.

General-purpose rust and oxidation lubricating oil

General-purpose rust and oxidation (R&O) inhibited oils are the most common type of industrial lubricant. They are used to lubricate Timken® bearings in all types of industrial applications where conditions requiring special considerations do not exist.

TABLE 39. SUGGESTED GENERAL PURPOSE R&O LUBRICATING OIL PROPERTIES

Properties	
Base stock	Solvent-refined, high-viscosity-index petroleum oil
Additives	Corrosion and oxidation inhibitors
Viscosity index	80 min.
Pour point	-10° C max. (14° F)
Viscosity grades	ISO/ASTM 32 through 220

Some low-speed and/or high-ambient-temperature applications require the higher viscosity grades. High-speed and/or low-temperature applications require the lower viscosity grades.

Industrial extreme-pressure (EP) gear oil

Extreme-pressure gear oils are used to lubricate Timken bearings in most types of heavily loaded industrial equipment. They should be capable of withstanding abnormal shock loads that are common in heavy-duty equipment.

TABLE 40. SUGGESTED INDUSTRIAL EP GEAR OIL PROPERTIES

Properties	
Base stock	Solvent-refined, high-viscosity-index petroleum oil
Additives	Corrosion and oxidation inhibitors Extreme-pressure (EP) additive ⁽¹⁾ - 15.8 kg (35 lb.) min.
Viscosity index	80 min.
Pour point	-10° C max. (14° F)
Viscosity grades	ISO/ASTM 100, 150, 220, 320, 460

⁽¹⁾ ASTM D 2782

Industrial EP gear oils should be composed of a highly refined petroleum oil-based stock plus appropriate inhibitors and additives. They should not contain materials that are corrosive or abrasive to bearings. The inhibitors should provide long-term protection from oxidation and protect the bearing from corrosion in the presence of moisture. The oils should resist foaming in service and have good water-separation properties. An EP additive protects against scoring under boundary-lubrication conditions. The viscosity grades suggested represent a wide range. High-temperature and/or slow-speed applications generally require the higher viscosity grades. Low temperatures and/or high speeds require the use of lower viscosity grades.

GREASE LUBRICATION

Grease lubrication is generally applicable to low-to-moderate speed applications that have operating temperatures within the limits of the grease. There is no universal anti-friction bearing grease. Each grease has limiting properties and characteristics.

Greases consist of a base oil, a thickening agent and additives. Conventionally, bearing greases have consisted of petroleum base oils thickened to the desired consistency by some form of metallic soap. More recently synthetic base oils have been used with organic and inorganic thickeners. Table 41 summarizes the composition of typical lubricating greases.

TABLE 41. COMPOSITION OF GREASES

Base Oil	+	Thickening Agents	+	Additives	=	Lubricating Grease
Mineral oil		Soaps and complex soaps		Rust inhibitors		
Synthetic hydrocarbon		lithium, aluminum, barium, calcium		Dyes		
Esters		Non-Soap (inorganic)		Tactifiers		
Perfluorinated oil		microgel (clay), carbon black, silica-gel, PTFE		Metal deactivates		
Silicone		Non-Soap (organic)		Oxidation inhibitors		
		Polyurea compounds		Anti-wear EP		

Calcium- and aluminum-based greases have excellent water resistance and are used in industrial applications where water ingress is an issue. Lithium-based greases are multi-purpose and are used in industrial applications and wheel bearings.

Synthetic base oils such as esters, organic esters and silicones used with conventional thickeners and additives typically have higher maximum operating temperatures than petroleum-based greases. Synthetic greases can be designed to operate in temperatures from -73° C (-100° F) to 288° C (550° F).

Below are the general characteristics of common thickeners used with petroleum base oils.

TABLE 42. GENERAL CHARACTERISTICS OF THICKENERS USED WITH PETROLEUM BASE OILS

Thickener	Typical Dropping Point		Maximum Temperature		Typical Water Resistance
	°C	°F	°C	°F	
Lithium soap	193	380	121	250	Good
Lithium complex	260+	500+	149	300	Good
Aluminum complex	249	480	149	300	Excellent
Calcium sulfonate	299	570	177	350	Excellent
Polyurea	260	500	149	300	Good

Use of the thickeners in table 42 with synthetic hydrocarbon or ester base oils increases the maximum operating temperature by approximately 10° C (50° F).

Using polyurea as a thickener for lubricating fluids is one of the most significant lubrication developments in more than 30 years. Polyurea grease performance is outstanding in a wide range of bearing applications and, in a relatively short time, it has gained acceptance as a factory-packed lubricant for ball bearings.

LOW TEMPERATURES

Starting torque in a grease-lubricated bearing at low temperatures can be critical. Some greases may function adequately as long as the bearing is operating, but resistance to initial movement may be excessive. In certain smaller machines, starting may be impossible when very cold. Under such operating circumstances, greases containing low-temperature characteristic oils are generally required.

If the operating temperature range is wide, synthetic greases offer advantages. Synthetic greases are available to provide very low starting and running torque at temperatures as low as -73° C (-100° F). In certain instances, these greases perform better in this respect than oil.

An important point concerning lubricating greases is that the starting torque is not necessarily a function of the consistency or the channel properties of the grease. Starting torque is more a function of the individual rheological properties of a particular grease and is best evaluated by application experience.

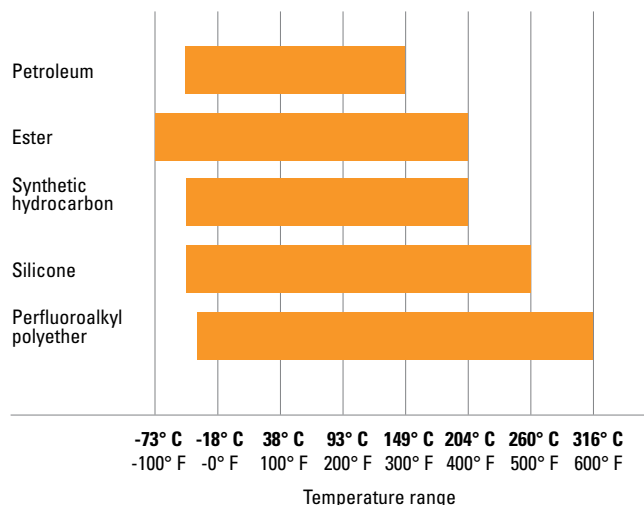
HIGH TEMPERATURES

The high temperature limit for lubricating greases is generally a function of the thermal and oxidation stability of the fluid and the effectiveness of the oxidation inhibitors. Grease temperature ranges are defined by both the dropping point of the grease thickener and composition of the base oil. Table 43 shows the temperature ranges of various base oils used in grease formulations.

A rule of thumb, developed from years of testing grease-lubricated bearings, indicates that grease life is halved for every 10° C (50° F) increase in temperature. For example, if a particular grease provides 2000 hours of life at 90° C (194° F), by raising the temperature to 100° C (212° F), reduction in life to approximately 1000 hours would result. On the other hand, 4000 hours could be expected by lowering the temperature to 80° C (176° F).

Thermal stability, oxidation resistance and temperature limitations must be considered when selecting greases for high-temperature applications. In non-relubricatable applications, highly refined mineral oils or chemically stable synthetic fluids are required as the oil component of greases for operation at temperatures above 121° C (250° F).

TABLE 43. TEMPERATURE RANGES FOR BASE OILS USED IN LUBRICATING GREASES



CONTAMINATION

Abrasive Particles

When roller bearings operate in a clean environment, the primary cause of damage is the eventual fatigue of the surfaces where rolling contact occurs. However, when particle contamination enters the bearing system, it is likely to cause damage such as bruising, which can shorten bearing life.

When dirt from the environment or metallic wear debris from some component in the application are allowed to contaminate the lubricant, wear can become the predominant cause of bearing damage. If bearing wear becomes significant, changes will occur to critical bearing dimensions that could adversely affect machine operation.

Bearings operating in a contaminated lubricant exhibit a higher initial rate of wear than those running in an uncontaminated lubricant. With no further contaminant ingress, this wear rate quickly diminishes. The contamination particles are reduced in size as they pass through the bearing contact area during normal operation.

Water

Water and moisture can be particularly conducive to bearing damage. Lubricating greases may provide a measure of protection from this contamination. Certain greases, such as calcium and aluminum-complex, are highly water-resistant.

Sodium-soap greases are water-soluble and should not be used in applications involving water.

Either dissolved or suspended water in lubricating oils can exert a detrimental influence on bearing fatigue life. Water can cause bearing etching that also can reduce bearing fatigue life. The exact mechanism by which water lowers fatigue life is not fully understood. It has been suggested that water enters micro-cracks in the bearing rings that are caused by repeated stress cycles. This leads to corrosion and hydrogen embrittlement in the micro-cracks, reducing the time required for these cracks to propagate to an unacceptable-sized spall.

Water-based fluids, such as water glycol and invert emulsions, also have shown a reduction in bearing fatigue life. Although water from these sources is not the same as contamination, the results support the previous discussion concerning water-contaminated lubricants.

GREASE SELECTION

The successful use of bearing grease depends on the physical and chemical properties of the lubricant as well as application and environmental conditions. Because the choice of grease for a particular bearing under certain service conditions is often difficult to make, you should consult with your lubricant supplier or equipment maker for specific questions about lubrication requirements for your application. You also can contact your Timken engineer for general lubrication guidelines for any application.

Grease must be carefully selected with regard to its consistency at operating temperature. It should not exhibit thickening, separation of oil, acid formation or hardening to any marked degree. It should be smooth, non-fibrous and entirely free from chemically active ingredients. Its dropping point should be considerably higher than the operating temperature.

Timken® application-specific lubricants were developed by leveraging our knowledge of tribology and anti-friction bearings, and how these two elements affect overall system performance. Timken lubricants help bearings and related components operate effectively in demanding industrial operations. High-temperature, anti-wear and water-resistant additives offer superior protection in challenging environments. Table 44 provides an overview of the Timken greases available for general applications. Contact your Timken engineer for a more detailed publication on Timken lubrication solutions.

TABLE 44. GREASE LUBRICATION SELECTION GUIDE

ENVIRONMENT		APPLICATION
High Wear • Moderate Loads Moderate Speeds Moderate Temperatures	→	←
	Timken Premium All-Purpose Industrial Grease	Agriculture • Bushings/Ball Joints Truck and Auto Wheel Bearings Heavy-Duty Industrial
↓		↓
Extreme Heat • Heavy Loads High Sliding Wear Dirty Environments Slow Speeds • Shock Loading	→	←
	Timken Construction and Off-Highway Grease	Agriculture/Mining • Cement Plants Construction/Off Road • Rock Quarry Earth-Moving Equipment Fleet Equipment • Heavy Industry Pivot Pins/Splined Shafts
↓		↓
Wet and Corrosive Conditions Quiet Environments • Light Loads Moderate to High Speeds Moderate Temperatures Light Load Moderate Water	→	←
	Timken Ball Bearing Pillow Block Grease	Lightly Loaded Pillow Blocks Idler Pulleys • Oven Conveyors Electric Motors • Fans • Pumps Alternators • Generators
↓		↓
Corrosive Media • Extreme Heat Heavy Loads • Wet Conditions Slow to Moderate Speeds	→	←
	Timken Mill Grease	Aluminum Mills • Paper Mills Steel Mills • Offshore Rigs Power Generation
↓		↓
Incidental Food Contact Hot and Cold Temperatures Moderate to High Speeds Medium Loads	→	←
	Timken Food Safe Grease	Food and Beverage Industries Pharmaceuticals
↓		↓
Extreme Low and High Temperatures Severe Loads Corrosive Media Slow to Moderate Speeds	→	←
	Timken Synthetic Industrial Grease	Wind Energy Main Bearing Pulp and Paper Machines General Heavy Industry Marine Applications Centralized Grease Systems
↓		↓
Moderate Speeds Light to Moderate Loads Moderate Temperatures Moderate Water	→	←
	Timken Multi-Use Lithium Grease	General Industrial Applications Pins and Bushings • Track Rollers Water Pumps Plain and Anti-friction Bearings

This selection guide is not intended to replace the specifications by the equipment builder, who is responsible for its performance.

Many bearing applications require lubricants with special properties or lubricants formulated specifically for certain environments, such as:

- Friction oxidation (fretting corrosion).
- Chemical and solvent resistance.
- Food handling.
- Quiet running.
- Space and/or vacuum.
- Electrical conductivity.

For assistance with these or other areas requiring special lubricants, consult your Timken engineer.

GREASE USE GUIDELINES

It is important to use the proper amount of grease in the application. In typical industrial applications, the bearing cavity should be kept approximately one-third to one-half full. Less grease may result in the bearing being starved for lubrication. More grease may result in churning. Both conditions may result in excessive heat generation. As the grease temperature rises, viscosity decreases and the grease becomes thinner. This can reduce the lubricating effect and increase leakage of the grease from the bearing. It also may cause the grease components to separate, leading to a general breakdown of the lubricant properties. As the grease breaks down, bearing torque increases. In the case of excess grease resulting in churning, torque may also increase due to the resistance caused by the grease.

For best results, there should be ample space in the housing to allow room for excess grease to be thrown from the bearing. However, it is equally important that the grease be retained all around the bearing. If a large void exists between the bearings, grease closures should be used to prevent the grease from leaving the bearing area.

Only in low-speed applications may the housing be entirely filled with grease. This method of lubrication is a safeguard against the entry of foreign matter, where sealing provisions are inadequate for exclusion of contaminants or moisture.

During periods of non-operation, it is often wise to completely fill the housings with grease to protect the bearing surfaces. Prior to restarting operation, remove the excess grease and restore the proper level.

Applications utilizing grease lubrication should have a grease fitting and a vent at opposite ends of the housing near the top. A drain plug should be located near the bottom of the housing to allow the old grease to purge from the bearing.

Bearings should be relubricated at regular intervals to help prevent damage. Relubrication intervals are difficult to determine. If plant practice or experience with other applications is not available, consult your lubricant supplier.

Timken offers a range of lubricants to help bearings and related components operate effectively in demanding industrial operations. High-temperature, anti-wear and water-resistant additives offer greater protection in challenging environments. Timken also offers a line of single- and multi-point lubricators to simplify grease delivery.



Fig. 23. Grease can easily be packed by hand.



Fig. 24. Mechanical grease packer.

Grease application methods

Grease, in general, is easier to use than oil in industrial bearing lubrication applications. Most bearings that are initially packed with grease require periodic relubrication to operate efficiently.

Grease should be packed into the bearing so that it gets between the rolling elements – the rollers or balls. For tapered roller bearings, forcing grease through the bearing from the large end to the small end will ensure proper distribution.

Grease can be easily packed into small- and medium-size bearings by hand (fig. 23). In shops where bearings are frequently regreased, a mechanical grease packer that forces grease through the bearing under pressure may be appropriate (fig. 24). Regardless of the method, after packing the internal areas of the bearing, a small amount of grease also should be smeared on the outside of the rollers or balls.

The two primary considerations that determine the relubrication cycle are operating temperature and sealing efficiency. High-operating-temperature applications generally require more frequent regreasing. The less efficient the seals, the greater the grease loss and the more frequently grease must be added.

Grease should be added any time the amount in the bearing falls below the desired amount. The grease should be replaced when its lubrication properties have been reduced through contamination, high temperature, water, oxidation or any other factors. For additional information on appropriate regreasing cycles, consult with the equipment manufacturer or your Timken engineer.

Prelubricated bearings

Prelubricated shielded and sealed bearings are successfully used in applications where:

- Grease might be injurious to other parts of the mechanism.
- Cost and space limitations preclude the use of a grease-filled housing.
- Housings cannot be kept free of dirt and grit, water or other contaminants.
- Relubrication is impossible or would be a hazard to satisfactory use.

Prelubricated bearings are pre-packed with greases that have chemical and mechanical stability, and they have demonstrated long-life characteristics in rotating bearings. Greases are filtered several times to remove all harmful material, and they are accurately metered so that each bearing receives the proper amount of grease.

CONSISTENCY

Greases may vary in consistency from semi-fluids that are hardly thicker than a viscous oil to solid grades almost as hard as a soft wood.

Consistency is measured by a penetrometer in which a standard weighted cone is dropped into the grease. The distance the cone penetrates (measured in tenths of a millimeter in a specific time) is the penetration number.

The National Lubricating Grease Institute (NLGI) classification of grease consistency is shown below:

TABLE 45. NLGI CLASSIFICATIONS

NLGI Grease Grades	Penetration Number
0	355-385
1	310-340
2	265-295
3	220-250
4	175-205
5	130-160
6	85-115

Grease consistency is not fixed; it normally becomes softer when sheared or “worked.” In the laboratory, this “working” is accomplished by forcing a perforated plate up and down through a closed container of grease. This “working” does not compare with the violent shearing action that takes place in a bearing and does not necessarily correlate with actual performance.

TABLE 46. GREASE COMPATIBILITY CHART

	Al Complex	Ba Complex	Ca Stearate	Ca 12 Hydroxy	Ca Complex	Ca Sulfonate	Clay Non-Soap	Li Stearate	Li 12 Hydroxy	Li Complex	Polyurea	Polyurea S S
Aluminum Complex	Best Choice	Incompatible	Incompatible	Compatible	Incompatible	Borderline	Incompatible	Incompatible	Incompatible	Compatible	Incompatible	Compatible
Timken Food Safe	Best Choice	Incompatible	Incompatible	Compatible	Incompatible	Borderline	Incompatible	Incompatible	Incompatible	Compatible	Incompatible	Compatible
Barium Complex	Incompatible	Best Choice	Incompatible	Compatible	Incompatible	Compatible	Incompatible	Incompatible	Incompatible	Incompatible	Incompatible	Borderline
Calcium Stearate	Incompatible	Incompatible	Best Choice	Compatible	Incompatible	Compatible	Compatible	Compatible	Borderline	Compatible	Incompatible	Compatible
Calcium 12 Hydroxy	Compatible	Compatible	Compatible	Best Choice	Borderline	Borderline	Compatible	Compatible	Compatible	Compatible	Incompatible	Compatible
Calcium Complex	Incompatible	Incompatible	Incompatible	Borderline	Best Choice	Incompatible	Incompatible	Incompatible	Incompatible	Compatible	Compatible	Compatible
Calcium Sulfonate	Borderline	Compatible	Compatible	Borderline	Incompatible	Best Choice	Incompatible	Borderline	Borderline	Compatible	Incompatible	Compatible
Timken Premium Mill Timken Heavy-Duty Moly	Borderline	Compatible	Compatible	Borderline	Incompatible	Best Choice	Incompatible	Borderline	Borderline	Compatible	Incompatible	Compatible
Clay Non-Soap	Incompatible	Incompatible	Compatible	Compatible	Incompatible	Incompatible	Best Choice	Incompatible	Incompatible	Incompatible	Incompatible	Borderline
Lithium Stearate	Incompatible	Incompatible	Compatible	Compatible	Incompatible	Borderline	Incompatible	Best Choice	Compatible	Compatible	Incompatible	Compatible
Lithium 12 Hydroxy	Incompatible	Incompatible	Borderline	Compatible	Incompatible	Borderline	Incompatible	Compatible	Best Choice	Compatible	Incompatible	Compatible
Lithium Complex	Compatible	Incompatible	Compatible	Compatible	Compatible	Compatible	Incompatible	Compatible	Compatible	Best Choice	Incompatible	Compatible
Polyurea Conventional	Incompatible	Incompatible	Incompatible	Incompatible	Compatible	Incompatible	Incompatible	Incompatible	Incompatible	Incompatible	Best Choice	Compatible
Polyurea Shear Stable	Compatible	Borderline	Compatible	Compatible	Compatible	Compatible	Borderline	Compatible	Compatible	Compatible	Compatible	Best Choice
Timken Multi-Use	Incompatible	Incompatible	Borderline	Compatible	Incompatible	Borderline	Incompatible	Compatible	Best Choice	Compatible	Incompatible	Compatible
Timken All-Purpose Timken Synthetic	Compatible	Incompatible	Compatible	Compatible	Compatible	Compatible	Incompatible	Compatible	Compatible	Best Choice	Incompatible	Compatible
Timken Pillow Block	Compatible	Borderline	Compatible	Compatible	Compatible	Compatible	Borderline	Compatible	Compatible	Compatible	Compatible	Best Choice

NOTE

*Mixing greases can result in improper bearing lubrication.
Always follow the specific lubrication instructions of your equipment supplier.*

TAPERED ROLLER BEARINGS

Timken offers the most extensive line of tapered roller bearings in the world. Tapered roller bearings consist of four interdependent components: the cone (inner ring), the cup (outer ring), the tapered rollers (rolling elements) and the cage (roller retainer). Tapered roller bearings are uniquely designed to manage both thrust and radial loads between a rotating and non-rotating member. The steeper the cup angle, the greater the ability of the bearing to handle thrust loads.

- **Sizes:** 8 mm (0.315 in.) bore to 3000 mm (118 in.) outside diameter (O.D.).
- **Industries:** Aerospace, agriculture, automotive, heavy truck, cement, aggregate, coal, oil and gas, construction, gear drives, machine tools, mining, paper, metals, rail and wind.
- **Features:** Available in single-, double- and four-row configurations. Refer to www.timken.com for four-row information. Customized designs and features are available upon request.
- **Benefits:** Enhanced performance in demanding applications.



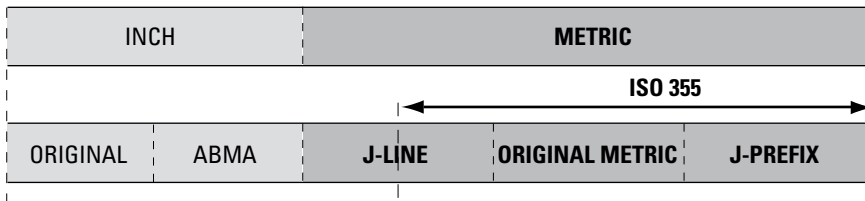
Tapered Roller Radial Bearings	
Part-Numbering Systems	72
Single-Row	
TS	87
IsoClass	399
TSF	417
TSL	489
Double-Row	
TDO	493
TDI	593
TDIT	624
TNA	631
TNASW	643
TNASWE	648
2TS-IM	653
2TS-DM	682
2S	706
SR	710

Tapered Roller Thrust Bearings	
Part-Numbering Systems	720
TTHD	721
TTHDFL	722
TTVS	724
TTSP	725
TTC, TTCS, TCL	728
Auxiliary Parts	731

PART-NUMBERING SYSTEMS FOR RADIAL TAPERED ROLLER BEARINGS

HOW TO IDENTIFY YOUR PART NUMBER

The part-numbering systems for single-row radial tapered roller bearings (type TS) are internationally recognized. Several part-numbering systems have been developed that can be classified according to metric or inch systems. Inch system bearings are normally assigned individual part numbers for the inner ring and for the outer ring, whereas ISO (metric) bearings are assigned a unique part number for the bearing assembly as a whole, which includes both inner and outer ring.



NOTE: ISO 355 is a dimensional plan for metric tapered roller bearings. See page 78 for more details on ISO 355.

Fig. 25. Part-numbering standards.

BEARING SERIES

In all the part-numbering systems, the term bearing series is used to describe bearings having the same basic internal geometry (e.g. roller size, inner-ring and outer-ring angles). Any inner ring (including roller set) can be matched with any outer ring within the same series providing that the same type of bearing is being used.

INCH PART-NUMBERING SYSTEMS

ORIGINAL INCH PART-NUMBERING SYSTEM

The original system developed by The Timken Company was based on a family of bearings designed around a common roller. Varying the number of rollers and the angle of the raceways allows different bearings to be designed for predominantly radial loads (shallow angle) or thrust loads (steep angle).

For example, all the tapered roller bearings in the 500 family use the same roller. However, the 595 Series has a steep angle and 24 rollers while the 525 Series has a shallow angle and 15 rollers.

Individual part numbers are assigned to the inner and outer rings. Although there are exceptions, the general rule is that the outer ring has a part number that is lower than that of the inner ring.

ABMA INCH PART-NUMBERING SYSTEM

The current inch part-numbering system was developed by the American Bearing Manufacturers Association (ABMA) to address the expansion in the number of new applications and tapered roller-bearing designs. This part-numbering system has become the international standard for inch-sized bearings.

The ABMA part-numbering system has been applied only to new bearing series designed after its introduction. Other part-numbering systems also are in use including those based on the original numbering system and proprietary part numbers for special bearings.

The ABMA part number is divided into five alphanumeric sections, which are described in fig. 26.

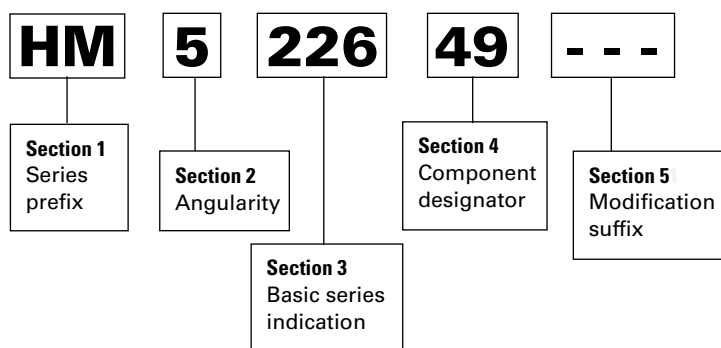


Fig. 26. ABMA inch part-numbering system nomenclature.

Section 1 - Series prefix

The series prefix consists of one or two letters that designate the duty class for which the bearing is designed. Additional prefix letters are available in table 49 on page 80.

TABLE 47. COMMON PREFIX LETTERS

Prefix	Class Designation	Prefix	Class Designation
EL	Extra light	HM	Heavy medium
LL	Lighter than light	H	Heavy
L	Light	HH	Heavier than heavy
LM	Light medium	EH	Extra heavy
M	Medium	T	Thrust only

Section 2 - Angularity designator

The first digit following the prefix represents the angle coding as determined by the included angle of the outer ring.

TABLE 48. ANGULARITY DESIGNATOR

Included Outer-Ring Angle	Code
0° to 23° 59' 59.99 in.	1
24° to 25° 29' 59.99 in.	2
25° 30' to 26° 59' 59.99 in.	3
27° to 28° 29' 59.99 in.	4
28° 30' to 30° 29' 59.99 in.	5
30° 30' to 32° 29' 59.99 in.	6
32° 30' to 35° 59' 59.99 in.	7
36° to 44° 59' 59.99 in.	8
45° and over; excluding thrust	9

Section 3 - Basic series indication

The two or three digits following the angularity designator are reserved for the basic series indication. Refer to ABMA standard 19.2 for more information.

Section 4 - Component designator

The last two numerical digits indicate the component number.

Section 5 - Modification suffix letters

The suffix may consist of one to three letters in pre-arranged combinations, indicating modifications in external form or internal arrangement. Table 49 on page 80 lists the most common prefix and suffix designations.

METRIC PART-NUMBERING SYSTEMS

J-LINE PART NUMBERS

Some ABMA (inch) part numbers are designed with metric envelope dimensions. The J prefix letter is used in conjunction with the ABMA part-numbering system to identify metric-dimensioned and toleranced inner rings and outer rings. The J-prefix is shown before the ABMA prefix letters. J-Line bearings are referred to as inch bearings in metric bore, O.D. and width.

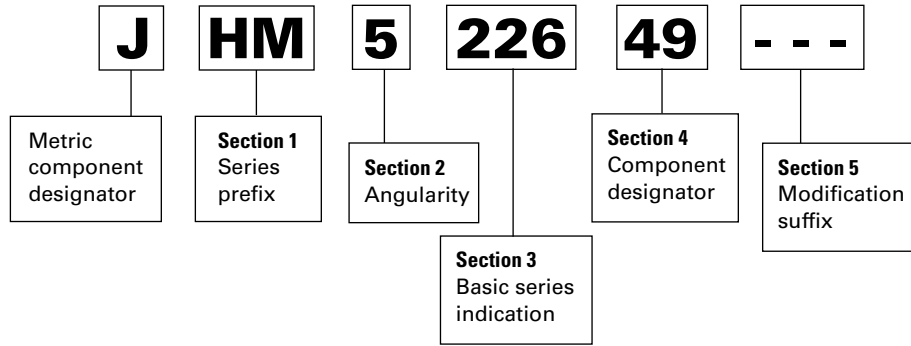


Fig. 27. J-Line part-numbering system nomenclature.

J-PREFIX

A range of metric bearings originally designed by The Timken Company also were included in the ISO 355 plan. These bearings are specifically application-oriented and are designed for optimum performance. Depending on application and type of load, thrust and/or radial, the bearing with the optimum angle and section can be selected. For example, pinion bearings have a steep angle, whereas bearings for machine tools are generally designed with a shallow angle and a light section. Fig. 29 demonstrates this feature for 55 mm (2.1654 in.) bore bearings.

These bearings also are identified with a J-prefix, which indicates a metric dimensioned and toleranced bearing.

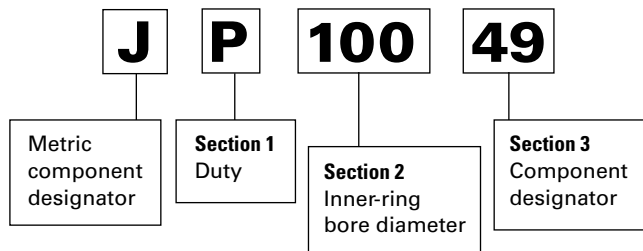


Fig. 28. J-prefix part-numbering system nomenclature.

Section 1 - Duty

Indicates application type:

- C, D & F = general purpose
- N = combination of general purpose and pinion
- P = high speed
- S & T = pinions
- W = high axial loads

Section 2 - Inner-ring bore

The inner-ring bore metric diameter is included in the part-number designation of both the inner ring and outer rings.

Section 3 - Component designator

Same identification as in the ABMA part-numbering system.

TAPERED ROLLER BEARINGS

PART-NUMBERING SYSTEMS

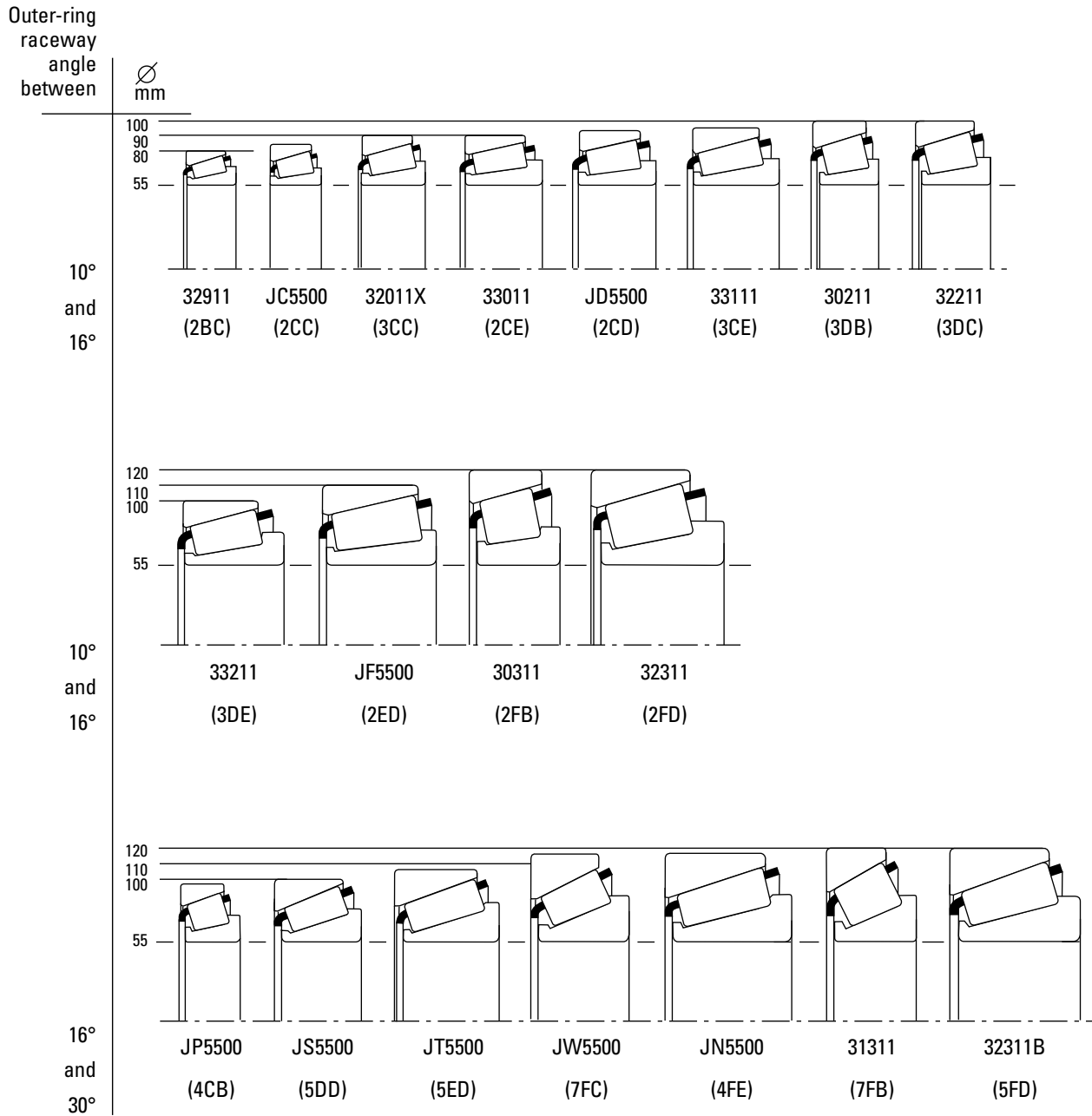


Fig. 29. Comparison of metric bearing designs for 55 mm (2.1654 in.) bore.

ORIGINAL METRIC (ISO) PART-NUMBERING SYSTEM

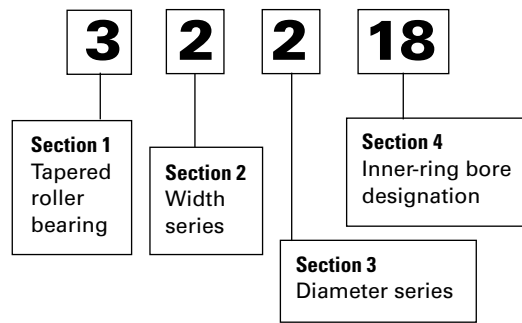


Fig. 30. Original ISO part-numbering system nomenclature.

The original metric part-numbering system for tapered roller bearings was based on the ISO 15 dimensional plan for radial bearings. A five-digit part number commencing with numeral 3 describes the bearing assembly (inner rings and outer rings).

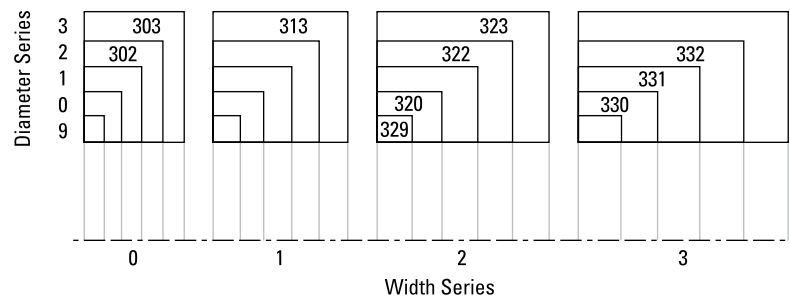


Fig. 31. Original ISO part-numbering system.

Section 1 - Symbol for bearing type

3 always applies to tapered roller bearings.

Section 2 - Width series

The bearing width is classified as 9 and 0 through 3 in increasing order of width.

Section 3 - Diameter series

The bearing section height is classified as 9 and 0 through 3 in increasing order of O.D. for a given bore size.

Section 4 - Inner-ring bore designation

The last two digits multiplied by five yield the inner-ring bore diameter in millimeters.

There are two exceptions to this rule:

1. Small bearings where: 02 = 15 mm, 03 = 17 mm
2. Where the last two digits are preceded by a forward slash (/), the last two digits show the actual bore size in millimeters. Examples:

- 32218 = 90 mm bore
- 30203 = 17 mm bore
- 329/28 = 28 mm bore

ISO 355 PART NUMBERING

As dimensions given by the ISO 15 general plan were not found to be optimal for tapered roller bearings, ISO introduced a new numbering system for tapered roller bearings in ISO 355. The numbering system of ISO 355 uses three alphanumeric fields to define a dimension series. The bearing part number is

then defined by adding the inner-ring diameter in mm after the dimension series. Although the original metric part numbers were assigned a new designation in the ISO 355 plan, the original part number is still used.

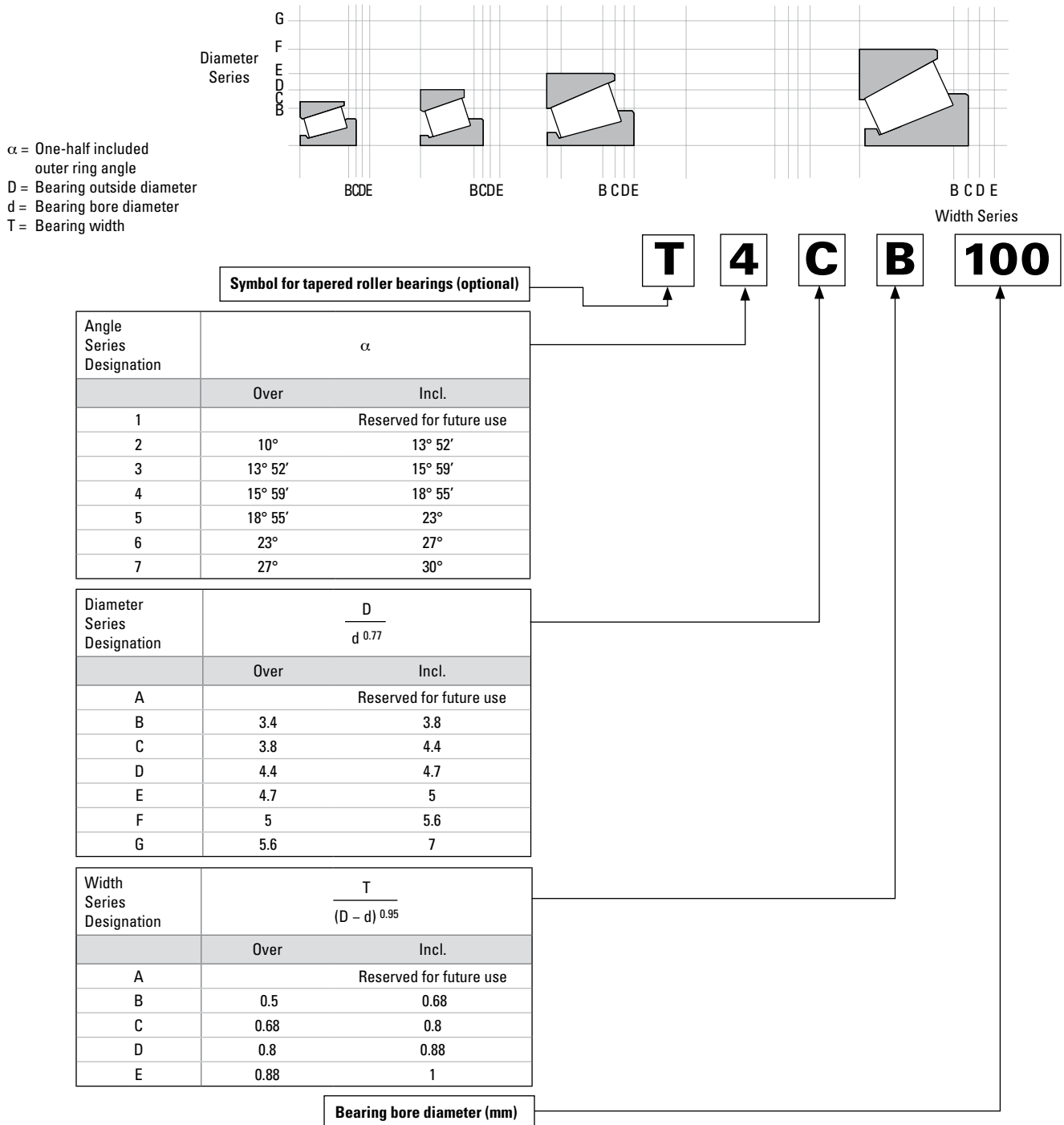


Fig. 32. ISO 355 part-numbering system.

BEARING ASSEMBLY NUMBERS

The nomenclature for a bearing assembly consists of the inner-ring part number followed by a five-digit alphanumeric code, e.g. LM48548-902A7. The assembly nomenclature describes the bill of material of the assembly.

An assembly number is assigned on receipt of the first order for new applications. It is very important for correct function of the bearing in a given application that the same assembly number is quoted for all subsequent orders. A Timken engineer should be consulted if additional information is required on the assembly number.

HISTORICAL PART-NUMBERING SYSTEMS

This historical nomenclature is for reference purposes only. Contact your Timken engineer with questions or for more information.

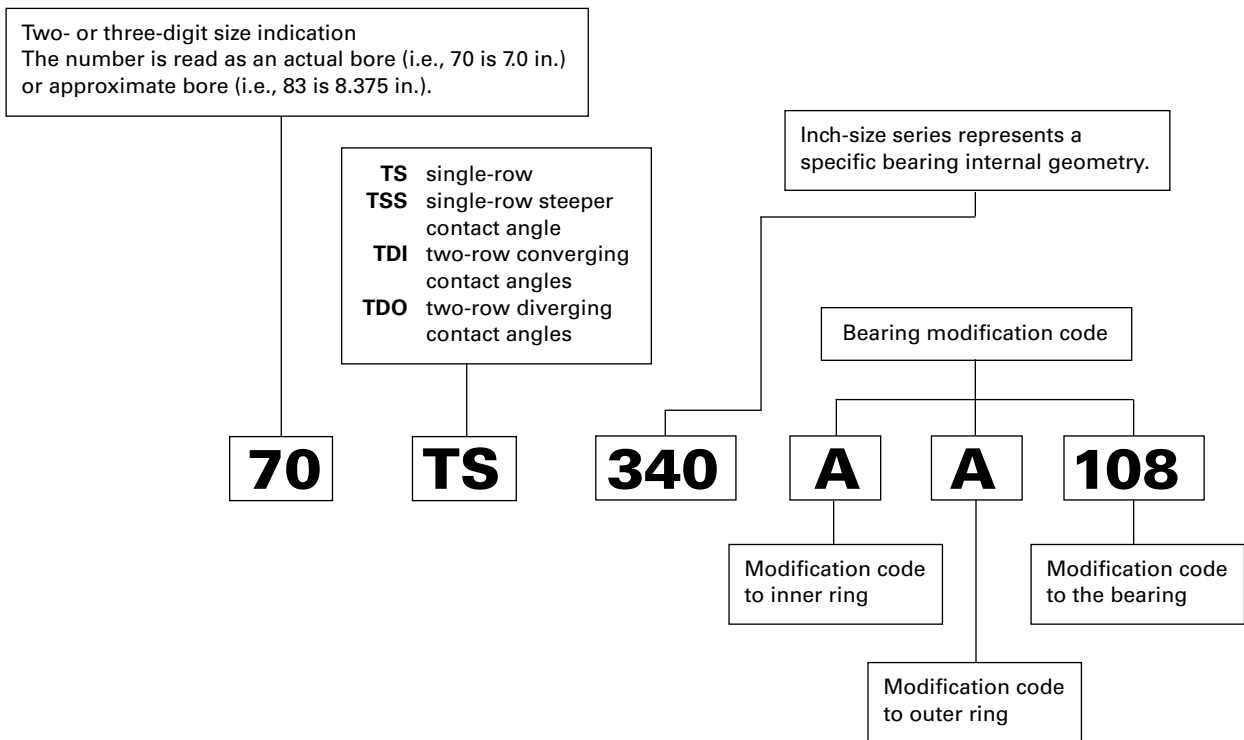


Fig. 33. Historical radial tapered roller bearing nomenclature.

For further explanation of prefix and suffix symbols or proprietary part numbers of special bearings, consult your Timken engineer.

PREFIXES AND SUFFIXES

The following are some of the symbols used by The Timken Company and prefixes and suffixes that are part of the ABMA part numbering standard:

TABLE 49. PREFIXES AND SUFFIXES

Prefix	Suffix	Inner Ring or Outer Ring	Explanation
A		Inner ring & outer ring	Standard basic series part number.
	A	Inner ring	Different radius from basic part number.
	A	Inner ring	Different bore from basic part number.
	A	Inner ring	Different complement of rollers.
	A	Outer ring	Different O.D. from basic part number.
	A	Outer ring	Different radius from basic part number.
	A	Outer ring	Different width from basic part number.
	AA	Inner ring & outer ring	Different bore, O.D., width or radius from basic part number.
	AB	Inner ring	Different bore, width or radius from basic part number, assembled with brass cage.
	AB	Outer ring	Flanged outer ring. Non-interchangeable with basic part number.
	AC	Inner ring	Different bore or radius, different internal geometry.
	AC	Outer ring	Different O.D., width or radius from basic part number.
	AD	Outer ring	Double outer ring. Non-interchangeable with basic part number.
	ADW	Inner ring	Double inner ring. Pilots and slots each end, holes in large rib.
	AH	Inner ring	Assembled with special cage, rollers, and/or internal geometry.
	AL	Inner ring	Assembled with DUO-FACE seal.
	ARB	Outer ring	Single outer ring with snap ring groove in O.D.
	AS	Inner ring & outer ring	Different bore, O.D., width, or radius from basic part number.
	ASB	Inner ring	Single inner ring, different bore or width from basic part number, assembled with brass cage.
	AV	Inner ring & outer ring	Made of special steel.
	AW	Inner ring & outer ring	Keyway or slotted inner ring or outer ring.
	AX	Inner ring & outer ring	Different bore, O.D., width, or radius from basic part number.
	AXB	Inner ring	Different bore, width, or radius from basic part number, assembled with brass cage.
	AXD	Outer ring	ISO outer ring - double outer ring without oil holes or groove.
	AXV	Inner ring & outer ring	Different O.D., width, or radius from basic part number. Made of special steel.
	AXX	Inner ring & outer ring	Different O.D., width, or radius from basic part number. Made of special steel.
	B	Outer ring	Flanged outer ring. Non-interchangeable with basic part number.
	B	Inner ring	Inner ring using brass cage.
	B	Inner ring & outer ring	ISO bearing with same boundary dimensions as basic part number, but with different internal geometry, steeper included outer-ring angle.
	BA	Outer ring	Flanged outer ring. Non-interchangeable with basic part number.
	BNA	Inner ring	ISO inner ring used in assemblies with two inner rings mated with double outer ring to form a double-row, non-adjusting bearing. Non-interchangeable with other inner rings having the same basic part numbers, which may vary in bore or width dimensions.
	BR	Outer ring	Single outer ring with groove in O.D. for snap ring.
	BS	Outer ring	Flanged outer ring. Non-interchangeable with basic part number.
	BW	Outer ring	Flanged outer ring with slot. Non-interchangeable with basic part number.
	BX	Outer ring	Flanged outer ring. Non-interchangeable with basic part number.
	BXX	Outer ring	Flanged single outer ring. Made of special steel.
	C	Inner ring	Single inner ring, envelope dimensions same as basic part number, different internal geometry.
	C	Outer ring	Dimensionally different from basic part number. Non-interchangeable.
	CA	Inner ring	Single inner ring, envelope dimensions same as basic part number, different internal geometry.
	CB	Inner ring	Single inner ring, dimensionally different from basic part number.
	CD	Outer ring	Double outer ring with oil holes and groove. One hole counterbored for locking pin.
	CE	Outer ring	Dimensionally different from basic part number. Non-interchangeable.
CN		Outer ring	Neoprene-cushioned outer ring.

Prefix	Suffix	Inner Ring or Outer Ring	Explanation
	CP	Inner ring & outer ring	Flash-chrome plated. Otherwise, interchangeable with basic part number.
	CP	Inner ring & outer ring	Envelope dimensions same as basic part number, different internal geometry, customized for performance.
	CR	Inner ring & outer ring	Ribbed outer-ring bearing series.
	CS	Inner ring & outer ring	Dimensionally different from basic part number. Non-interchangeable.
	CX	Inner ring	Dimensionally different from basic part number. Non-interchangeable.
	D	Inner ring & outer ring	Double inner ring or double outer ring. Non-interchangeable with basic part number.
	DA	Inner ring	Double inner ring. Non-interchangeable with inner rings having same basic part number.
	DA	Outer ring	Spherical O.D. double outer ring. Non-interchangeable with basic part number or other double outer rings having same basic numbers.
	DB	Outer ring	Double outer ring with flange. Non-interchangeable with basic part number or double outer rings having same basic numbers.
	DB	Inner ring	Double inner ring assembled with brass cages.
	DD	Inner ring & outer ring	Special long double inner ring or outer ring. Non-interchangeable with basic part number or other double parts having same basic numbers.
	DE	Inner ring & outer ring	Double inner ring or double outer ring having different dimensions or other characteristics from single and double parts identified with same basic part number.
	DF	Outer ring	Double outer ring with oil holes and groove. Snap ring groove on O.D.
	DG	Inner ring	Double inner ring with pressure-removal groove or helical groove in bore.
	DGA	Inner ring	Double inner ring with pressure-removal groove or helical groove in bore. Non-interchangeable with basic part number.
	DGE	Inner ring	Double inner ring with pressure-removal groove or helical groove in bore. Non-interchangeable with basic part number.
	DGH	Inner ring	Double inner ring with pressure-removal groove or helical groove in bore and with special cage, rollers, and/or internal geometry.
	DGW	Inner ring	Double inner ring with pressure-removal groove or helical groove in bore, and having face slots.
	DH	Inner ring	Double inner ring with special cage, rollers, and/or internal geometry.
	DP	Inner ring	Double inner ring with puller groove.
	DR	Outer ring	Double outer ring for ribbed outer-ring series. Non-interchangeable with single and double outer rings identified with same basic part number.
	DRB	Outer ring	Double outer ring with snap-ring groove.
	DS	Outer ring	Crowned O.D. double outer ring. Non-interchangeable with other outer rings having same basic part numbers.
	DT	Outer ring	Tapered O.D. double outer ring. Non-interchangeable with other outer rings having same basic part numbers.
	DV	Inner ring & outer ring	Double inner ring or double outer ring made of special steel.
	DVH	Inner ring	Double inner ring, special steel, and/or internal geometry.
	DW	Inner ring & outer ring	Double inner ring or double outer ring with keyway or slot. Non-interchangeable with inner rings or outer rings identified with same basic part numbers.
	DWA	Inner ring	Double inner ring with one end extended and with oil slots in extended end (asymmetrical).
	DWH	Inner ring	Double inner ring with oil slots, assembled with special cage, rollers, and/or internal geometry.
	DWV	Inner ring & outer ring	Double inner ring or double outer ring with keyway or slot. Non-interchangeable with inner rings or outer rings identified with same basic part numbers. Made of special steel.
DX		Inner ring & outer ring	DuraSpexx power rating series.
	DX	Outer ring	Adaptor for spherical or straight O.D. outer ring.
	DX	Outer ring	Threaded O.D. double outer ring. Non-interchangeable with outer rings identified with same basic part numbers.
	DXX	Inner ring & outer ring	Double inner ring or double outer ring made of special steel.
	E	Inner ring & outer ring	Inner rings or outer rings having special characteristics differing from and non-interchangeable with other inner rings or outer rings identified with the same basic part numbers.
	ED	Outer ring	Double outer rings. Non-interchangeable with other outer rings identified with same basic part numbers.
	EDC	Outer ring	Double outer rings, special hole in O.D. for locking pin.
EE		Inner ring	Large and small ribs - close-guided rollers. Non-interchangeable with other inner rings identified with same basic part numbers.
EH		Inner ring & outer ring	Extra-heavy series.

TAPERED ROLLER BEARINGS

PART-NUMBERING SYSTEMS

Prefix	Suffix	Inner Ring or Outer Ring	Explanation
EL		Inner ring & outer ring	Extra light series.
EX		Inner ring & outer ring	Experimental.
	EXX	Inner ring & outer ring	Inner rings or outer rings having special characteristics differing from and non-interchangeable with other inner rings or outer rings identified with the same basic part numbers. Made of special steel.
	F	Inner ring	Assembled with polymer cage.
FL		Inner ring & outer ring	Free lateral series, no large or small ribs.
FX		Inner ring & outer ring	Factory identification number only.
	G	Inner ring	Cage groove in bore.
H		Inner ring & outer ring	Heavy series. Non-interchangeable with other inner rings and outer rings identified with same basic part numbers.
	H	Inner ring	Assembled with special cage, rollers, and/or internal geometry.
	HV	Inner ring	Assembled with special cage, rollers, and/or internal geometry. Made of special steel.
HH		Inner ring & outer ring	Heavy-heavy series. Non-interchangeable with other inner rings and outer rings identified with same basic part numbers.
HM		Inner ring & outer ring	Heavy-medium series. Non-interchangeable with other inner rings or outer rings identified with same basic part numbers.
	HP	Inner ring	Assembled with special cage and/or roller, different internal geometry. Customized for performance.
	HR	Outer ring	Special outer ring used in Hydra-Rib bearing.
J		Inner ring & outer ring	Used alone or with other prefix letters to indicate metric bore and/or O.D.
JC		Inner ring & outer ring	Metric series.
JD		Inner ring & outer ring	Metric series.
JE		Inner ring & outer ring	Metric series.
JF		Inner ring & outer ring	Metric series.
JG		Inner ring & outer ring	Metric series.
JN		Inner ring & outer ring	Metric series.
JP		Inner ring & outer ring	Metric series.
JR		Inner ring & outer ring	Metric series.
JRM		Inner ring & outer ring	Metric series, UNIPAC bearing.
JS		Inner ring & outer ring	Metric series.
JT		Inner ring & outer ring	Metric series.
JU		Inner ring & outer ring	Metric series.
JW		Inner ring & outer ring	Metric series.
K		Outer ring	Double outer ring with heavy section. May have unusual features such as flange, tapered O.D., etc.
K		Inner ring & outer ring	Through-hardened components, non-DIN 720 part numbers.
K		Miscellaneous	K prefix with five or six digits following also used for miscellaneous components (seals, bolts, filler rings, etc.).
	KP	Thrust bearing	Cadmium plated.
L		Inner ring & outer ring	Light series. Non-interchangeable with other inner rings and outer rings identified with same basic part numbers.
	L	Inner ring	Inner ring assembled with DUO-FACE seal.
	L	Outer ring	Loose rib. Part of unit-bearing.
	LA	Inner ring	Inner ring assembled with DUO-FACE-PLUS seal.
	LA, LB, LC, etc.	Seal	These suffixes are used on a basic DUO-FACE-PLUS seal number to identify the assembly resulting from the use of the seal with various inner rings in the series.
LL		Inner ring & outer ring	Light-light series.
LM		Inner ring & outer ring	Light-medium series.
M		Inner ring & outer ring	Medium series.
	M	Inner ring & outer ring	Through-hardened components, DIN 720 part numbers, IsoClass part numbers.
N		Inner ring	Bock- or Gilliam-type bearings.
NA	NA	Inner ring	Two inner rings mated with double outer ring to form double-row non-adjustable bearing. Non-interchangeable with other inner rings having same basic part numbers which may vary in bore, O.D., and width dimensions.
	NA	Outer ring	Etched electric pencil on double outer rings mated with two NA-type single inner rings to form double-row non-adjustable bearings.

Prefix	Suffix	Inner Ring or Outer Ring	Explanation
	NAV	Inner ring	NA inner ring made of special steel.
	NC	Outer ring	Cushioned outer ring (usually neoprene.)
	NI	Inner ring	Tapered or threaded bore.
NP		Inner ring & outer ring	Used with random numbers for product differentiation.
	NR	Inner ring	NA-type ribless inner ring for ribbed outer-ring series.
	NW	Inner ring	NA-type inner ring with slotted front face.
	NWV	Inner ring	NA-type inner ring with slotted front face. Made of special steel.
	NX	Inner ring	Lapped front face.
	P	Inner ring	Puller groove.
	P	Inner ring & outer ring	Customized for performance.
R		Inner ring & outer ring	Gilliam replacement series. Non-interchangeable with other inner rings and outer rings identified with same basic numbers.
	R	Inner ring & outer ring	Special feature bearing. Non-interchangeable with bearings having the same basic part numbers.
	R	Inner ring & outer ring	Bock-type bearing.
	R	Inner ring	Basic part number with polymer lubricant.
	RB	Outer ring	Snap ring on O.D.
RC		Inner ring & outer ring	Special ribbed outer-ring bearing.
	RN	Various	Used with random numbers, not to exceed six digits, for purchased items that are distributed by Timken.
	RR	Inner ring & outer ring	Relieved ring.
	S	Inner ring & outer ring	Special feature bearing. Non-interchangeable with bearings having same basic part numbers.
	SA	Inner ring & outer ring	Special feature bearing. Non-interchangeable with bearings having same basic part numbers.
	SB	Inner ring	Assembled with brass cage.
	SB	Outer ring	Flanged outer ring.
	SC	Inner ring	With square bore.
	SD	Inner ring & outer ring	Double inner ring with square bore or double outer ring.
	SH	Inner ring	Special feature bearing, with special cage, rollers, and/or internal geometry. Non-interchangeable with bearings having same basic part numbers.
	SL	Thrust bearing	Basic part number with polymer lubricant.
	SR	Inner ring	Different radius from basic part numbers.
	SW	Inner ring & outer ring	Slot or keyway. Non-interchangeable with bearings having same basic part numbers.
	SWB	Inner ring	Slot or keyway assembled with brass cage. Non-interchangeable with bearings having same basic part numbers.
	SWV	Inner ring	Slot or keyway made of special steel. Non-interchangeable with bearings having same basic part numbers.
	SX	Outer ring	Special feature bearing. Non-interchangeable with bearings having same basic part numbers.
T		Rings	Thrust bearing assemblies.
T		Outer rings	Double outer ring with heavy section. May have unusual feature such as flange, tapered O.D., etc.
	T	Inner ring	Tapered bore.
	T	Outer ring	Tapered O.D.
	TA	Inner ring	Tapered bore NA-type inner ring.
	TA	Outer ring	Tapered O.D.
	TB	Inner ring	Tapered-bore inner ring with brass cage.
TC		Rings	Thrust bearing assemblies.
	TC	Inner rings	Tapered bore.
	TD	Inner ring	Double with tapered bore.
	TDB	Inner ring	Double with tapered bore, assembled with brass cages.
	TDE	Inner ring	Double with tapered bore and extended rib.
	TDG	Inner ring	Double with tapered bore, pressure-removal groove or spiral groove in bore.
	TDGV	Inner ring	Double with tapered bore, pressure-removal groove or spiral groove in bore. Made of special steel.
	TDH	Inner ring	Double with tapered bore, special cage, rollers or internal geometry.
	TDL	Inner ring	Double with tapered bore, interlock feature.
	TDV	Inner ring	Double with tapered bore. Made of special steel.

TAPERED ROLLER BEARINGS

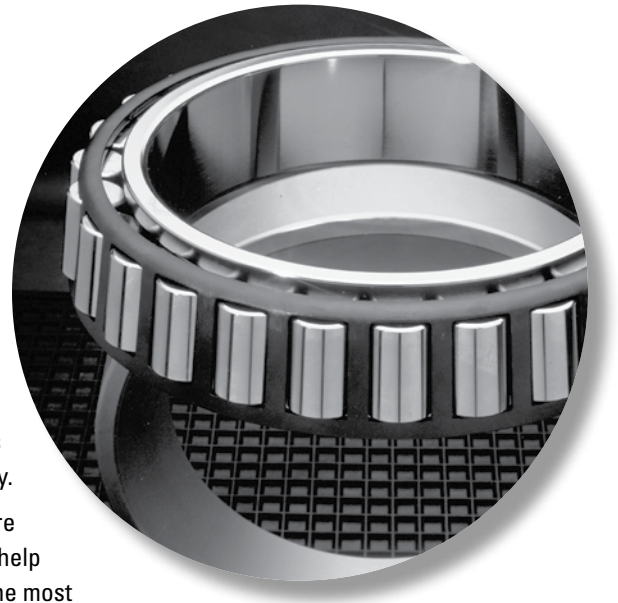
PART-NUMBERING SYSTEMS

Prefix	Suffix	Inner Ring or Outer Ring	Explanation
	TDW	Inner ring	Double with tapered bore and slots or keys.
	TDXX	Inner ring	Double with tapered bore. Made of special steel.
	TE	Inner ring	Single, tapered bore, extended large rib.
	TEV	Inner ring	Single, tapered bore, extended large rib. Made of special steel.
	TL	Inner ring	Tapered-bore with interlock feature.
	TLE	Inner ring	Tapered-bore with interlock feature and extended rib.
	TP	Inner ring	Tapered-bore inner ring with puller groove.
	TPE	Inner ring	Tapered-bore inner ring with puller groove, extended inner-ring large rib.
	TV	Inner ring & outer ring	Tapered-bore inner ring or outer ring O.D. Made of special steel.
	TW	Inner ring & outer ring	Tapered-bore inner ring or outer ring O.D. with slots or keys.
	TWE	Inner ring & outer ring	Tapered-bore inner ring or outer ring O.D. with locking keyway in front face, extended inner ring large rib or outer ring width.
	TXX	Inner ring	Tapered bore. Made of special steel.
U		Inner ring & outer ring	Basic series part number, unitized, self-contained.
	U	Inner ring & outer ring	Basic series part number, unitized, self-contained.
	US	Inner ring & outer ring	Special close stand.
V		Inner ring & outer ring	Special close stand.
	V	Inner ring & outer ring	Made of special steel.
	VC	Inner ring	Special internal geometry. Made of special steel.
	VH	Inner ring	Special cage, rollers, and/or internal geometry. Made of special steel.
	W	Inner ring & outer ring	Slot(s) or keyway(s).
	W	Thrust bearing	Oil holes in retainer.
	WA	Inner ring & outer ring	Slot(s) or keyway(s).
	WB	Inner ring	Slot(s) or keyway(s) with brass cage.
	WC	Inner ring & outer ring	Slot(s) or keyway(s).
	WD	Inner ring & outer ring	Double inner ring or outer ring with slot(s) or keyway(s).
	WE	Inner ring & outer ring	Extended face with slot(s) or keyway(s).
	WS	Inner ring & outer ring	Slot(s) or keyway(s).
WV		Inner ring & outer ring	Slot(s) or keyway(s). Made of special steel.
	WXX	Inner ring & outer ring	Slot(s) or keyway(s). Made of special steel.
X		Inner ring	ISO part number.
	X	Inner ring	Slot(s) or keyway(s).
	X	Inner ring & outer ring	Special feature bearing. Non-interchangeable with bearings having the same basic part number.
	X	Inner ring & outer ring	ISO bearing with same boundary dimensions as basic part number but with different internal geometry, yielding increased rating.
	XA	Inner ring & outer ring	Special feature bearing. Non-interchangeable with bearings having the same basic part number.
XAA		Inner ring	ISO single inner ring. Non-interchangeable with bearings having the same basic part number.
XAB		Inner ring	ISO single inner ring. Non-interchangeable with bearings having the same basic part number.
	XB	Inner ring	Different bore, width, or radius, from basic part number. Assembled with brass cage.
	XB	Outer ring	Special feature flanged outer ring. Non-interchangeable with bearings having the same basic part number.
XC		Inner ring & outer ring	Limited production bearings to which standard series part numbers have not been assigned.
	XD	Outer ring	Double outer ring, no oil holes or groove.
	XD	Inner ring	Double inner ring, different bore or width from basic part numbers.
	XD	Inner ring	Double inner ring, oil holes in large rib.
	XDXP	Outer ring	Double outer ring, no oil holes or groove, special material and process.
	XE	Outer ring	Different bore, width, or radius from basic part number.
XGA		Inner ring	ISO single inner ring. Non-interchangeable with bearings having the same basic part number.
XGB		Inner ring	ISO single inner ring. Non-interchangeable with bearings having the same basic part number.
	XP	Inner ring	Special steel and process.
XR		Inner ring & outer ring	Crossed roller bearings.
	XS	Inner ring & outer ring	Different bore, O.D., width, or radius from basic part number.

Prefix	Suffix	Inner Ring or Outer Ring	Explanation
	XV	Inner ring & outer ring	Special feature inner ring or outer ring made of special steel.
	XW	Inner ring	Slotted.
	XX	Inner ring & outer ring	Single inner ring or single outer ring. Made of special steel.
Y		Outer ring	ISO part number.
	YD	Outer ring	Double outer ring with oil holes, no groove.
	YDA	Outer ring	Double outer ring with oil holes, no groove. Non-interchangeable with bearings having the same basic part number.
	YDV	Outer ring	Double outer ring with oil holes, no groove. Made of special steel.
	YDW	Inner ring	Double outer ring with oil holes, no groove. Slots or keyways in faces.
YKA		Outer ring	ISO single outer ring. Non-interchangeable with bearings having the same basic part number.
YKB		Outer ring	ISO single outer ring. Non-interchangeable with bearings having the same basic part number.
YSA		Outer ring	ISO single outer ring. Non-interchangeable with bearings having the same basic part number.
	Z	Inner ring & outer ring	Close stand part.

TYPE TS

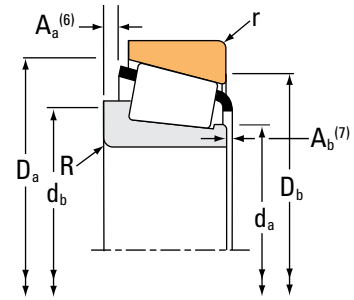
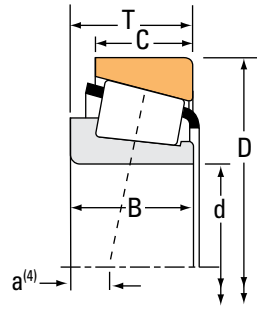
- TS style is the most widely used tapered roller bearing.
- Part numbers give specifiers the widest possible choice from the comprehensive range of metric (ISO and J prefix) and inch sizes available from The Timken Company.
- Consult your Timken engineer before making a final bearing selection to help ensure suitability, availability and the most cost-effective solution.



TAPERED ROLLER BEARINGS

SINGLE-ROW • TYPE TS

TYPE TS



Bearing Dimensions			Load Ratings						Part Number			
Bore d	O.D. D	Width T	Dynamic ⁽¹⁾		Factors ⁽²⁾		Dynamic ⁽³⁾		Static		Inner	Outer
			C ₁	e	Y	C ₉₀	C _{a90}	K	C ₀			
mm in.	mm in.	mm in.	N lbf			N lbf	N lbf		N lbf			
7.937 0.3125	31.991 1.2595	10.008 0.3940	10800 2430	0.41	1.48	2800 630	1940 437	1.44	9230 2070		A2031	A2126
9.525 0.3750	31.991 1.2595	10.008 0.3940	10800 2430	0.41	1.48	2800 630	1940 437	1.44	9230 2070		A2037	A2126
11.112 0.4375	34.988 1.3775	10.998 0.4330	13200 2960	0.45	1.32	3410 767	2640 594	1.29	11500 2580		A4044	A4138
11.987 0.4719	31.991 1.2595	10.008 0.3940	10800 2430	0.41	1.48	2800 630	1940 437	1.44	9230 2070		A2047	A2126
12.680 0.4992	34.988 1.3775	10.998 0.4330	13200 2960	0.45	1.32	3410 767	2640 594	1.29	11500 2580		A4049	A4138
12.700 0.5000	34.988 1.3775	10.998 0.4330	13200 2960	0.45	1.32	3410 767	2640 594	1.29	11500 2580		A4050	A4138
12.700 0.5000	38.100 1.5000	13.495 0.5313	20900 4690	0.28	2.18	5410 1220	2550 574	2.12	17100 3840		00050	00150
14.989 0.5901	34.988 1.3775	10.998 0.4330	13200 2960	0.45	1.32	3410 767	2640 594	1.29	11500 2580		A4059	A4138
15.875 0.6250	34.988 1.3775	10.998 0.4330	14300 3230	0.32	1.88	3720 836	2030 456	1.83	13900 3130		L21549	L21511
15.875 0.6250	39.992 1.5745	12.014 0.4730	13400 3020	0.53	1.14	3480 782	3140 705	1.11	12300 2770		A6062	A6157
15.875 0.6250	41.275 1.6250	14.288 0.5625	24000 5400	0.31	1.93	6230 1400	3310 745	1.88	21300 4780		03062	03162
15.875 0.6250	42.862 1.6875	14.288 0.5625	18800 4230	0.70	0.85	4870 1100	5860 1320	0.83	17400 3920		11590	11520
15.875 0.6250	42.862 1.6875	16.670 0.6563	31400 7070	0.33	1.81	8150 1830	4620 1040	1.76	29200 6560		17580	17520
15.875 0.6250	47.000 1.8504	14.381 0.5662	26700 6010	0.36	1.68	6930 1560	4230 952	1.64	25400 5720		05062	05185
15.875 0.6250	49.225 1.9380	19.845 0.7813	42800 9630	0.27	2.26	11100 2500	5050 1140	2.20	40500 9100		09062	09195
15.875 0.6250	49.225 1.9380	23.020 0.9063	42800 9630	0.27	2.26	11100 2500	5050 1140	2.20	40500 9100		09062	09194
15.875 0.6250	53.975 2.1250	22.225 0.8750	55100 12400	0.59	1.02	14300 3210	14400 3250	0.99	42500 9560		21063	21212

⁽¹⁾Based on 1×10^6 revolutions L_{10} life, for the ISO life-calculation method.

⁽²⁾Consult your Timken engineer for instructions on use or review the Timken Engineering Manual on timken.com/catalogs.

⁽³⁾Based on 90×10^6 revolutions L_{10} life, for The Timken Company life-calculation method. C_{90} and C_{a90} are radial and thrust values.

Bearing Dimensions											Geometry Factors			Bearing Weight
Width B	Width C	Eff. Ctr. a ⁽⁴⁾	Shaft			Housing			Cage		G ₁	G ₂	C _g	
			Max Shaft Fillet Radius R ⁽⁵⁾	Backing Shoulder Dia. d _a	Backing Shoulder Dia. d _b	Max Housing Fillet Radius r ⁽⁵⁾	Backing Shoulder Dia. D _a	Backing Shoulder Dia. D _b	A _a ⁽⁶⁾	A _b ⁽⁷⁾				
mm in.	mm in.	mm in.	mm in.	mm in.	mm in.	mm in.	mm in.	mm in.	mm in.	mm in.				kg lbs.
10.785 0.4246	7.938 0.3125	-3.0 -0.12	0.5 0.02	12.5 0.49	13.0 0.51	1.3 0.05	29.0 1.14	26.0 1.02	-0.3 -0.01	1.5 0.06	1.7	3.2	0.0308	0.05 0.10
10.785 0.4246	7.938 0.3125	-3.0 -0.12	1.3 0.05	13.5 0.53	15.0 0.59	1.3 0.05	29.0 1.14	26.0 1.02	-0.3 -0.01	1.5 0.06	1.7	3.2	0.0308	0.05 0.10
10.988 0.4326	8.730 0.3437	-2.5 -0.10	1.3 0.05	15.5 0.61	17.5 0.69	1.3 0.05	32.0 1.26	29.0 1.14	0.1 0.00	1.2 0.05	2.3	4.1	0.0355	0.05 0.13
10.785 0.4246	7.938 0.3125	-3.0 -0.12	0.8 0.03	15.5 0.61	16.5 0.65	1.3 0.05	29.0 1.14	26.0 1.02	-0.3 -0.01	1.5 0.06	1.7	3.2	0.0308	0.04 0.09
10.988 0.4326	8.730 0.3437	-2.5 -0.10	0.8 0.03	17.5 0.69	17.5 0.69	1.3 0.05	32.0 1.26	29.0 1.14	0.1 0.00	1.2 0.05	2.3	4.1	0.0355	0.05 0.12
10.988 0.4326	8.730 0.3437	-2.5 -0.10	1.3 0.05	17.0 0.67	18.5 0.73	1.3 0.05	32.0 1.26	29.0 1.14	0.1 0.00	1.2 0.05	2.3	4.1	0.0355	0.05 0.12
14.072 0.5540	11.112 0.4375	-5.1 -0.20	1.5 0.06	16.5 0.65	19.0 0.75	0.8 0.03	34.0 1.34	33.0 1.30	-0.4 -0.02	1.3 0.06	3.1	2.9	0.0329	0.08 0.18
10.988 0.4326	8.730 0.3437	-2.5 -0.10	0.8 0.03	19.0 0.75	19.5 0.77	1.3 0.05	32.0 1.26	29.0 1.14	0.1 0.00	1.2 0.05	2.3	4.1	0.0355	0.04 0.11
10.998 0.4330	8.712 0.3430	-3.3 -0.13	1.3 0.05	19.5 0.77	21.5 0.85	1.3 0.05	32.5 1.28	29.0 1.14	-0.3 -0.02	1.4 0.06	3.0	5.4	0.0348	0.06 0.11
11.153 0.4391	9.525 0.3750	-1.5 -0.06	1.3 0.05	20.5 0.81	22.0 0.87	1.3 0.05	37.0 1.46	34.0 1.34	0.5 0.02	1.6 0.07	2.9	5.6	0.0404	0.08 0.16
14.681 0.5780	11.112 0.4375	-5.1 -0.20	1.3 0.05	20.0 0.79	21.5 0.85	2.0 0.08	37.5 1.48	34.0 1.34	0.3 0.01	1.4 0.06	4.2	4.0	0.0384	0.09 0.21
14.288 0.5625	9.525 0.3750	-1.3 -0.05	1.5 0.06	22.5 0.89	24.5 0.96	1.5 0.06	39.5 1.56	34.5 1.36	1.5 0.05	0.7 0.03	3.4	4.6	0.0465	0.10 0.22
16.670 0.6563	13.495 0.5313	-5.8 -0.23	1.5 0.06	21.0 0.83	23.0 0.91	1.5 0.06	39.0 1.54	36.5 1.44	0.4 0.01	1.9 0.08	5.3	4.5	0.0423	0.12 0.27
14.381 0.5662	11.112 0.4375	-4.1 -0.16	1.5 0.06	21.0 0.83	23.5 0.93	1.3 0.05	42.5 1.67	40.5 1.59	0.2 0.00	1.3 0.05	5.8	5.5	0.0448	0.14 0.29
21.539 0.8480	14.288 0.5625	-9.1 -0.36	0.8 0.03	21.5 0.85	22.0 0.87	1.3 0.05	44.5 1.75	42.0 1.65	2.2 0.09	0.7 0.03	8.0	4.0	0.0452	0.19 0.44
21.539 0.8480	17.462 0.6875	-9.1 -0.36	0.8 0.03	21.5 0.85	22.0 0.87	3.5 0.14	44.5 1.75	39.0 1.54	2.2 0.09	0.7 0.03	8.0	4.0	0.0452	0.21 0.47
21.839 0.8598	15.875 0.6250	-5.8 -0.23	0.8 0.03	26.4 1.03	29.0 1.14	2.3 0.09	50.0 1.97	43.0 1.69	1.3 0.05	2.0 0.08	7.0	4.1	0.0558	0.25 0.57

⁽⁴⁾Negative value indicates effective center inside cone (inner-ring) backface.

⁽⁵⁾These maximum fillet radii will be cleared by the bearing corners.

⁽⁶⁾Negative value indicates cage extends beyond cone (inner-ring) backface.

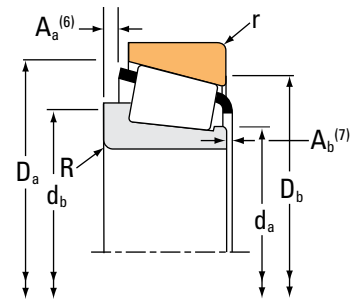
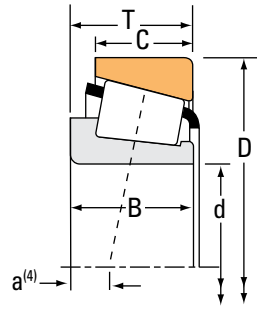
⁽⁷⁾Negative value indicates cage that does not extend beyond cone (inner-ring) front face.

Continued on next page.

TAPERED ROLLER BEARINGS

SINGLE-ROW • TYPE TS

TYPE TS



Bearing Dimensions			Load Ratings						Part Number				
Bore d	O.D. D	Width T	Dynamic ⁽¹⁾		Factors ⁽²⁾		Dynamic ⁽³⁾		Factors ⁽²⁾		Static C ₀	Inner	Outer
			C ₁	e	Y	C ₉₀	C _{a90}	K	N	N			
mm in.	mm in.	mm in.	N lbf			N lbf	N lbf		N lbf				
15.987 0.6294	46.975 1.8494	21.000 0.8268	40100 9020	0.55	1.10	10400 2340	9720 2190	1.07	39300 8840		HM81649	HM81610	
16.993 0.6690	39.982 1.5741	12.014 0.4730	13400 3020	0.53	1.14	3480 782	3140 705	1.11	12300 2770		A6067	A6157A	
16.993 0.6690	39.992 1.5745	12.014 0.4730	13400 3020	0.53	1.14	3480 782	3140 705	1.11	12300 2770		A6067	A6157	
16.993 0.6690	47.000 1.8504	14.381 0.5662	26700 6010	0.36	1.68	6930 1560	4230 952	1.64	25400 5720		05066	05185	
17.455 0.6872	36.525 1.4380	11.112 0.4375	13000 2930	0.49	1.23	3380 760	2820 634	1.20	11600 2600		A5069	A5144	
17.462 0.6875	39.878 1.5700	13.843 0.5450	29400 6600	0.29	2.10	7610 1710	3730 838	2.04	23400 5260		LM11749	LM11710	
17.462 0.6875	44.450 1.7500	12.700 0.5000	20300 4550	0.48	1.25	5250 1180	4310 969	1.22	20600 4640		4C	6	
17.462 0.6875	44.450 1.7500	15.494 0.6100	26700 6010	0.36	1.68	6930 1560	4230 952	1.64	25400 5720		05068	05175	
17.987 0.7082	47.000 1.8504	14.381 0.5662	26700 6010	0.36	1.68	6930 1560	4230 952	1.64	25400 5720		05070XS	05185-S	
18.000 0.7087	47.000 1.8504	14.381 0.5662	24700 5560	0.36	1.68	6420 1440	3920 881	1.64	25400 5720		05070X	05185-S	
19.004 0.7482	56.896 2.2400	19.368 0.7625	45400 10200	0.31	1.95	11800 2650	6200 1390	1.90	45300 10200		1774	1729	
19.004 0.7482	56.896 2.2400	19.368 0.7625	45400 10200	0.31	1.95	11800 2650	6200 1390	1.90	45300 10200		1774	1729X	
19.050 0.7500	39.992 1.5745	12.014 0.4730	13400 3020	0.53	1.14	3480 782	3140 705	1.11	12300 2770		A6075	A6157	
19.050 0.7500	41.275 1.6250	11.905 0.4687	13400 3020	0.53	1.14	3480 782	3140 705	1.11	12300 2770		A6075	A6162	
19.050 0.7500	44.450 1.7500	12.700 0.5000	20300 4550	0.48	1.25	5250 1180	4310 969	1.22	20600 4640		4A	6	
19.050 0.7500	45.237 1.7810	15.494 0.6100	39100 8800	0.30	2.00	10100 2280	5220 1170	1.94	32000 7200		LM11949	LM11910	
19.050 0.7500	47.000 1.8504	14.381 0.5662	26700 6010	0.36	1.68	6930 1560	4230 952	1.64	25400 5720		05075	05185	

⁽¹⁾Based on 1 x 10⁶ revolutions L₁₀ life, for the ISO life-calculation method.

⁽²⁾Consult your Timken engineer for instructions on use or review the Timken Engineering Manual on timken.com/catalogs.

⁽³⁾Based on 90 x 10⁶ revolutions L₁₀ life, for The Timken Company life-calculation method. C₉₀ and C_{a90} are radial and thrust values.

Bearing Dimensions											Geometry Factors			Bearing Weight
Width B	Width C	Eff. Ctr. a ⁽⁴⁾	Shaft			Housing			Cage		G ₁	G ₂	C _g	
			Max Shaft Fillet Radius R ⁽⁵⁾	Backing Shoulder Dia. d _a	Backing Shoulder Dia. d _b	Max Housing Fillet Radius r ⁽⁵⁾	Backing Shoulder Dia. D _a	Backing Shoulder Dia. D _b	A _a ⁽⁶⁾	A _b ⁽⁷⁾				
mm in.	mm in.	mm in.	mm in.	mm in.	mm in.	mm in.	mm in.	mm in.	mm in.	mm in.				kg lbs.
21.000 0.8268	16.000 0.6299	-6.1 -0.24	1.0 0.04	23.0 0.90	27.5 1.08	2.0 0.08	43.0 1.69	37.5 1.48	1.4 0.05	1.4 0.06	6.1	4.6	0.0526	0.20 0.42
11.153 0.4391	9.525 0.3750	-1.5 -0.06	0.8 0.03	21.0 0.83	22.0 0.87	1.3 0.05	36.5 1.44	34.0 1.34	0.5 0.02	1.6 0.07	2.9	5.6	0.0404	0.08 0.16
11.153 0.4391	9.525 0.3750	-1.5 -0.06	0.8 0.03	21.0 0.83	22.0 0.87	1.3 0.05	37.0 1.46	34.0 1.34	0.5 0.02	1.6 0.07	2.9	5.6	0.0404	0.08 0.16
14.381 0.5662	11.112 0.4375	-4.1 -0.16	1.5 0.06	22.0 0.87	24.5 0.96	1.3 0.05	42.5 1.67	40.5 1.59	0.2 0.00	1.3 0.05	5.8	5.5	0.0448	0.14 0.28
11.112 0.4375	7.938 0.3125	-2.0 -0.08	1.5 0.06	21.5 0.84	23.5 0.93	1.5 0.06	33.5 1.32	30.0 1.18	0.0 0.00	1.4 0.06	2.5	4.6	0.0376	0.05 0.11
14.605 0.5750	10.668 0.4200	-5.1 -0.20	1.3 0.05	22.0 0.87	24.0 0.94	1.3 0.05	37.0 1.46	34.0 1.34	0.4 0.01	0.7 0.03	4.8	4.7	0.0392	0.09 0.18
11.908 0.4688	9.525 0.3750	-1.8 -0.07	1.5 0.06	22.0 0.87	24.5 0.96	1.5 0.06	41.0 1.61	38.0 1.50	0.8 0.03	1.6 0.07	4.6	2.6	0.0456	0.09 0.21
14.381 0.5662	11.430 0.4500	-4.1 -0.16	0.8 0.03	22.5 0.89	23.0 0.91	1.5 0.06	42.0 1.65	38.0 1.50	0.2 0.00	1.3 0.05	5.8	5.5	0.0448	0.12 0.25
14.381 0.5662	11.112 0.4375	-4.1 -0.16	2.0 0.08	22.5 0.89	26.0 1.02	1.5 0.06	42.5 1.67	40.5 1.59	0.2 0.00	1.3 0.05	5.8	5.5	0.0448	0.13 0.27
14.381 0.5662	11.112 0.4375	-4.1 -0.16	1.5 0.06	22.5 0.89	25.0 0.98	1.5 0.06	42.5 1.67	40.5 1.59	0.2 0.00	1.3 0.05	5.8	5.5	0.0448	0.13 0.28
19.837 0.7810	15.875 0.6250	-6.9 -0.27	1.5 0.06	25.0 0.98	27.0 1.06	1.3 0.05	51.0 2.01	49.0 1.93	* *	* *	10.6	5.4	0.0521	0.26 0.59
19.837 0.7810	15.875 0.6250	-6.9 -0.27	1.5 0.06	25.0 0.98	27.0 1.06	1.5 0.06	51.0 2.01	49.0 1.93	* *	* *	10.6	5.4	0.0521	0.26 0.59
11.153 0.4391	9.525 0.3750	-1.5 -0.06	1.0 0.04	23.0 0.91	24.0 0.94	1.3 0.05	37.0 1.46	34.0 1.34	0.5 0.02	1.6 0.07	2.9	5.6	0.0404	0.07 0.14
11.153 0.4391	8.730 0.3437	-1.5 -0.06	1.0 0.04	23.0 0.91	24.0 0.94	1.3 0.05	37.0 1.46	34.5 1.36	0.5 0.02	1.6 0.07	2.9	5.6	0.0404	0.07 0.15
11.908 0.4688	9.525 0.3750	-1.8 -0.07	1.5 0.06	23.5 0.93	25.5 1.00	1.5 0.06	41.0 1.61	38.0 1.50	0.8 0.03	1.6 0.07	4.6	2.6	0.0456	0.09 0.20
16.637 0.6550	12.065 0.4750	-5.6 -0.22	1.3 0.05	23.5 0.93	25.0 0.98	1.3 0.05	41.5 1.63	39.5 1.56	0.2 0.01	0.8 0.03	6.6	5.5	0.0441	0.12 0.28
14.381 0.5662	11.112 0.4375	-4.1 -0.16	1.3 0.05	23.5 0.93	25.0 0.98	1.3 0.05	42.5 1.67	40.5 1.59	0.2 0.00	1.3 0.05	5.8	5.5	0.0448	0.13 0.27

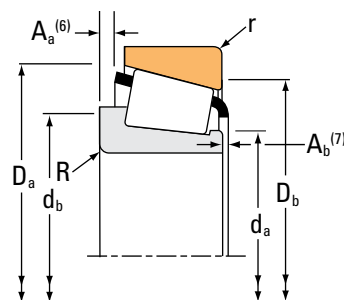
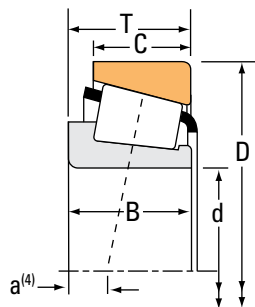
(4) Negative value indicates effective center inside cone (inner-ring) backface.
 (5) These maximum fillet radii will be cleared by the bearing corners.
 (6) Negative value indicates cage extends beyond cone (inner-ring) backface.
 (7) Negative value indicates cage that does not extend beyond cone (inner-ring) front face.
 (*) Contact your Timken engineer for details.

Continued on next page.

TAPERED ROLLER BEARINGS

SINGLE-ROW • TYPE TS

TYPE TS



Bearing Dimensions			Load Ratings						Part Number			
Bore d	O.D. D	Width T	Dynamic ⁽¹⁾		Factors ⁽²⁾		Dynamic ⁽³⁾		Static		Inner	Outer
			C ₁	e	Y	C ₉₀	C _{a90}	K	C ₀			
mm in.	mm in.	mm in.	N lbf			N lbf	N lbf		N lbf			
19.050 0.7500	47.000 1.8504	14.381 0.5662	26700 6010	0.36	1.68	6930 1560	4230 952	1.64	25400 5720		05075X	05185-S
19.050 0.7500	49.225 1.9380	18.034 0.7100	42800 9630	0.27	2.26	11100 2500	5050 1140	2.20	40500 9100		09067	09195
19.050 0.7500	49.225 1.9380	19.845 0.7813	42800 9630	0.27	2.26	11100 2500	5050 1140	2.20	40500 9100		09078	09195
19.050 0.7500	49.225 1.9380	19.845 0.7813	42800 9630	0.27	2.26	11100 2500	5050 1140	2.20	40500 9100		09074	09195
19.050 0.7500	49.225 1.9380	21.209 0.8350	42800 9630	0.27	2.26	11100 2500	5050 1140	2.20	40500 9100		09067	09194
19.050 0.7500	49.225 1.9380	21.209 0.8350	42800 9630	0.27	2.26	11100 2500	5050 1140	2.20	40500 9100		09067	09196
19.050 0.7500	49.225 1.9380	23.020 0.9063	42800 9630	0.27	2.26	11100 2500	5050 1140	2.20	40500 9100		09074	09194
19.050 0.7500	49.225 1.9380	23.020 0.9063	42800 9630	0.27	2.26	11100 2500	5050 1140	2.20	40500 9100		09074	09196
19.050 0.7500	49.225 1.9380	23.020 0.9063	42800 9630	0.27	2.26	11100 2500	5050 1140	2.20	40500 9100		09078	09194
19.050 0.7500	49.225 1.9380	23.020 0.9063	42800 9630	0.27	2.26	11100 2500	5050 1140	2.20	40500 9100		09078	09196
19.050 0.7500	50.800 2.0000	20.637 0.8125	42800 9630	0.27	2.26	11100 2500	5050 1140	2.20	40500 9100		09074	09201
19.050 0.7500	52.800 2.0787	18.034 0.7100	39100 8800	0.30	2.00	10100 2280	5220 1170	1.94	32000 7200		LM11949	LM11919
19.050 0.7500	52.883 2.0820	18.430 0.7256	42800 9630	0.27	2.26	11100 2500	5050 1140	2.20	40500 9100		09067	09194-S
19.050 0.7500	52.883 2.0820	20.241 0.7969	42800 9630	0.27	2.26	11100 2500	5050 1140	2.20	40500 9100		09074	09194-S
19.050 0.7500	53.975 2.1250	22.225 0.8750	55100 12400	0.59	1.02	14300 3210	14400 3250	0.99	42500 9560		21075	21212
19.050 0.7500	53.975 2.1250	22.225 0.8750	55100 12400	0.59	1.02	14300 3210	14400 3250	0.99	42500 9560		21075	21213
19.050 0.7500	53.975 2.1250	22.225 0.8750	55100 12400	0.59	1.02	14300 3210	14400 3250	0.99	42500 9560		21075A	21212

⁽¹⁾Based on 1×10^6 revolutions L_{10} life, for the ISO life-calculation method.

⁽²⁾Consult your Timken engineer for instructions on use or review the Timken Engineering Manual on timken.com/catalogs.

⁽³⁾Based on 90×10^6 revolutions L_{10} life, for The Timken Company life-calculation method. C_{90} and C_{a90} are radial and thrust values.

Bearing Dimensions											Geometry Factors			Bearing Weight
Width B	Width C	Eff. Ctr. a ⁽⁴⁾	Shaft			Housing			Cage		G ₁	G ₂	C _g	
			Max Shaft Fillet Radius R ⁽⁵⁾	Backing Shoulder Dia. d _a	Backing Shoulder Dia. d _b	Max Housing Fillet Radius r ⁽⁵⁾	Backing Shoulder Dia. D _a	Backing Shoulder Dia. D _b	A _a ⁽⁶⁾	A _b ⁽⁷⁾				
mm in.	mm in.	mm in.	mm in.	mm in.	mm in.	mm in.	mm in.	mm in.	mm in.	mm in.				kg lbs.
14.381 0.5662	11.112 0.4375	-4.1 -0.16	1.5 0.06	23.5 0.93	25.4 1.00	1.5 0.06	42.5 1.67	40.5 1.59	0.2 0.00	1.3 0.05	5.8	5.5	0.0448	0.13 0.27
19.050 0.7500	14.288 0.5625	-7.4 -0.29	1.3 0.05	24.0 0.94	25.5 1.00	1.3 0.05	44.5 1.75	42.0 1.65	0.4 0.01	1.3 0.05	8.0	4.0	0.0452	0.17 0.39
21.539 0.8480	14.288 0.5625	-9.1 -0.36	1.3 0.05	24.0 0.94	25.5 1.00	1.3 0.05	44.5 1.75	42.0 1.65	2.2 0.09	0.7 0.03	8.0	4.0	0.0452	0.17 0.41
21.539 0.8480	14.288 0.5625	-9.1 -0.36	1.5 0.06	24.0 0.94	26.0 1.02	1.3 0.05	44.5 1.75	42.0 1.65	2.2 0.09	0.7 0.03	8.0	4.0	0.0452	0.17 0.40
19.050 0.7500	17.462 0.6875	-7.4 -0.29	1.3 0.05	24.0 0.94	25.5 1.00	3.5 0.14	44.5 1.75	39.0 1.54	0.4 0.01	1.3 0.05	8.0	4.0	0.0452	0.19 0.42
19.050 0.7500	17.462 0.6875	-7.4 -0.29	1.3 0.05	24.0 0.94	25.5 1.00	1.5 0.06	44.5 1.75	41.5 1.63	0.4 0.01	1.3 0.05	8.0	4.0	0.0452	0.19 0.43
21.539 0.8480	17.462 0.6875	-9.1 -0.36	1.5 0.06	24.0 0.94	26.0 1.02	3.5 0.14	44.5 1.75	39.0 1.54	2.2 0.09	0.7 0.03	8.0	4.0	0.0452	0.19 0.43
21.539 0.8480	17.462 0.6875	-9.1 -0.36	1.5 0.06	24.0 0.94	26.0 1.02	1.5 0.06	44.5 1.75	41.5 1.63	2.2 0.09	0.7 0.03	8.0	4.0	0.0452	0.19 0.45
21.539 0.8480	17.462 0.6875	-9.1 -0.36	1.3 0.05	24.0 0.94	25.5 1.00	3.5 0.14	44.5 1.75	39.0 1.54	2.2 0.09	0.7 0.03	8.0	4.0	0.0452	0.19 0.44
21.539 0.8480	17.462 0.6875	-9.1 -0.36	1.3 0.05	24.0 0.94	25.5 1.00	1.5 0.06	44.5 1.75	41.5 1.63	2.2 0.09	0.7 0.03	8.0	4.0	0.0452	0.19 0.45
21.539 0.8480	17.462 0.6875	-9.1 -0.36	1.5 0.06	24.0 0.94	26.0 1.02	0.5 0.02	45.5 1.79	44.0 1.73	2.2 0.09	0.7 0.03	8.0	4.0	0.0452	0.20 0.47
16.637 0.6550	14.605 0.5750	-5.6 -0.22	1.3 0.05	23.5 0.93	25.0 0.98	1.3 0.05	45.5 1.79	42.0 1.65	0.2 0.01	0.8 0.03	6.6	5.5	0.0441	0.20 0.44
19.050 0.7500	14.684 0.5781	-7.4 -0.29	1.3 0.05	24.0 0.94	25.5 1.00	3.3 0.13	46.5 1.83	42.0 1.65	0.4 0.01	1.3 0.05	8.0	4.0	0.0452	0.21 0.45
21.539 0.8480	14.684 0.5781	-9.1 -0.36	1.5 0.06	24.0 0.94	26.0 1.02	3.3 0.13	46.5 1.83	42.0 1.65	2.2 0.09	0.7 0.03	8.0	4.0	0.0452	0.21 0.47
21.839 0.8598	15.875 0.6250	-5.8 -0.23	1.5 0.06	26.0 1.03	31.5 1.24	2.3 0.09	50.0 1.97	43.0 1.69	3.3 0.13	1.8 0.07	7.0	4.1	0.0558	0.24 0.54
21.839 0.8598	15.875 0.6250	-5.8 -0.23	1.5 0.06	26.0 1.03	31.5 1.24	0.5 0.02	50.0 1.97	44.5 1.75	3.3 0.13	1.8 0.07	7.0	4.1	0.0558	0.25 0.55
21.839 0.8598	15.875 0.6250	-5.8 -0.23	1.5 0.06	26.0 1.03	31.5 1.24	2.3 0.09	50.0 1.97	43.0 1.69	3.3 0.13	1.8 0.07	7.0	4.1	0.0558	0.24 0.54

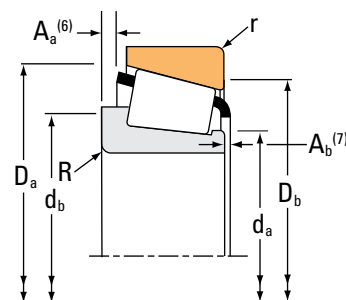
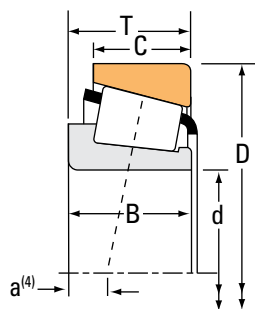
(4) Negative value indicates effective center inside cone (inner-ring) backface.
 (5) These maximum fillet radii will be cleared by the bearing corners.
 (6) Negative value indicates cage extends beyond cone (inner-ring) backface.
 (7) Negative value indicates cage that does not extend beyond cone (inner-ring) front face.

Continued on next page.

TAPERED ROLLER BEARINGS

SINGLE-ROW • TYPE TS

TYPE TS



Bearing Dimensions			Load Ratings							Part Number		
Bore d	O.D. D	Width T	Dynamic ⁽¹⁾ C ₁		Factors ⁽²⁾ e Y		Dynamic ⁽³⁾ C ₉₀ C _{a90}		Factors ⁽²⁾ K	Static C ₀	Inner	Outer
mm in.	mm in.	mm in.	N lbf				N lbf	N lbf		N lbf		
19.050 0.7500	56.896 2.2400	19.368 0.7625	45400 10200	0.31	1.95		11800 2650	6200 1390	1.90	45300 10200	1775	1729
19.987 0.7869	46.982 1.8497	14.381 0.5662	26700 6010	0.36	1.68		6930 1560	4230 952	1.64	25400 5720	05079	05185A
19.987 0.7869	46.990 1.8500	15.250 0.6004	26700 6010	0.36	1.68		6930 1560	4230 952	1.64	25400 5720	05079	05186
19.987 0.7869	47.000 1.8504	14.381 0.5662	26700 6010	0.36	1.68		6930 1560	4230 952	1.64	25400 5720	05079	05185
19.987 0.7869	47.000 1.8504	14.381 0.5662	26700 6010	0.36	1.68		6930 1560	4230 952	1.64	25400 5720	05079	05185-S
19.987 0.7869	51.994 2.0470	15.011 0.5910	27000 6060	0.40	1.49		6990 1570	4810 1080	1.45	29600 6650	07079X	07204
20.000 0.7874	51.994 2.0470	15.011 0.5910	29100 6540	0.40	1.49		7550 1700	5190 1170	1.45	29600 6650	07079	07204
20.627 0.8121	56.896 2.2400	19.368 0.7625	45400 10200	0.31	1.95		11800 2650	6200 1390	1.90	45300 10200	1778	1729
20.637 0.8125	49.225 1.9380	19.845 0.7813	43600 9810	0.32	1.86		11300 2540	6260 1410	1.81	43200 9720	12580	12520
21.430 0.8437	50.005 1.9687	17.526 0.6900	52200 11700	0.28	2.16		13500 3040	6440 1450	2.10	43500 9780	M12649	M12610
21.987 0.8656	45.237 1.7810	15.494 0.6100	38600 8680	0.31	1.96		10000 2250	5250 1180	1.91	35300 7930	LM12749	LM12710
21.987 0.8656	45.975 1.8100	15.494 0.6100	38600 8680	0.31	1.96		10000 2250	5250 1180	1.91	35300 7930	LM12749	LM12711
22.225 0.8750	42.070 1.6563	11.176 0.4400	16600 3730	0.40	1.51		4300 966	2920 655	1.47	16800 3770	LL52549	LL52510
22.225 0.8750	50.005 1.9687	13.495 0.5313	29100 6540	0.40	1.49		7550 1700	5190 1170	1.45	29600 6650	07087	07196
22.225 0.8750	50.005 1.9687	13.495 0.5313	29100 6540	0.40	1.49		7550 1700	5190 1170	1.45	29600 6650	07087X	07196
22.225 0.8750	50.005 1.9687	17.526 0.6900	52200 11700	0.28	2.16		13500 3040	6440 1450	2.10	43500 9780	M12648	M12610
22.225 0.8750	50.005 1.9687	17.526 0.6900	52200 11700	0.28	2.16		13500 3040	6440 1450	2.10	43500 9780	M12648A	M12610

⁽¹⁾Based on 1 x 10⁶ revolutions L₁₀ life, for the ISO life-calculation method.

⁽²⁾Consult your Timken engineer for instructions on use or review the Timken Engineering Manual on timken.com/catalogs.

⁽³⁾Based on 90 x 10⁶ revolutions L₁₀ life, for The Timken Company life-calculation method. C₉₀ and C_{a90} are radial and thrust values.

Bearing Dimensions											Geometry Factors			Bearing Weight
Width B	Width C	Eff. Ctr. a ⁽⁴⁾	Shaft			Housing			Cage		G ₁	G ₂	C _g	
			Max Shaft Fillet Radius R ⁽⁵⁾	Backing Shoulder Dia. d _a	Shoulder Dia. d _b	Max Housing Fillet Radius r ⁽⁵⁾	Backing Shoulder Dia. D _a	Shoulder Dia. D _b	A _a ⁽⁶⁾	A _b ⁽⁷⁾				
mm in.	mm in.	mm in.	mm in.	mm in.	mm in.	mm in.	mm in.	mm in.	mm in.	mm in.				kg lbs.
19.837 0.7810	15.875 0.6250	-6.9 -0.27	1.5 0.06	25.0 0.98	27.0 1.06	1.3 0.05	51.0 2.01	49.0 1.93	1.8 0.07	0.4 0.02	10.6	5.4	0.0521	0.26 0.59
14.381 0.5662	11.112 0.4375	-4.1 -0.16	1.5 0.06	24.0 0.94	26.5 1.04	1.5 0.06	42.5 1.67	40.5 1.59	0.2 0.00	1.3 0.05	5.8	5.5	0.0448	0.13 0.26
14.381 0.5662	12.000 0.4724	-4.1 -0.16	1.5 0.06	24.0 0.94	26.5 1.04	1.5 0.06	42.5 1.67	40.5 1.59	0.2 0.00	1.3 0.05	5.8	5.5	0.0448	0.13 0.27
14.381 0.5662	11.112 0.4375	-4.1 -0.16	1.5 0.06	24.0 0.94	26.5 1.04	1.3 0.05	42.5 1.67	40.5 1.59	0.2 0.00	1.3 0.05	5.8	5.5	0.0448	0.13 0.26
14.381 0.5662	11.112 0.4375	-4.1 -0.16	1.5 0.06	24.0 0.94	26.5 1.04	1.5 0.06	42.5 1.67	40.5 1.59	0.2 0.00	1.3 0.05	5.8	5.5	0.0448	0.13 0.26
14.260 0.5614	12.700 0.5000	-2.8 -0.11	1.5 0.06	26.0 1.02	27.5 1.08	1.3 0.05	48.0 1.89	45.0 1.77	0.2 0.01	1.5 0.06	7.6	7.1	0.0509	0.16 0.36
14.260 0.5614	12.700 0.5000	-2.8 -0.11	1.5 0.06	26.0 1.02	27.5 1.08	1.3 0.05	48.0 1.89	45.0 1.77	0.2 0.01	1.5 0.06	7.6	7.1	0.0509	0.16 0.36
19.837 0.7810	15.875 0.6250	-6.9 -0.27	0.8 0.03	26.0 1.02	27.0 1.06	1.3 0.05	51.0 2.01	49.0 1.93	* *	* *	10.6	5.4	0.0521	0.26 0.57
19.845 0.7813	15.875 0.6250	-7.1 -0.28	1.5 0.06	26.0 1.02	28.5 1.12	1.5 0.06	45.5 1.79	42.5 1.67	0.8 0.03	1.2 0.05	8.6	6.2	0.0495	0.18 0.40
18.288 0.7200	13.970 0.5500	-6.4 -0.25	1.3 0.05	27.5 1.08	29.5 1.16	1.3 0.05	46.0 1.81	44.0 1.73	0.3 0.01	1.2 0.05	9.1	5.6	0.0479	0.17 0.37
16.637 0.6550	12.065 0.4750	-5.3 -0.21	1.3 0.05	26.0 1.02	27.5 1.08	1.3 0.05	42.0 1.65	39.5 1.56	0.5 0.02	0.5 0.02	8.2	7.4	0.0480	0.12 0.26
16.637 0.6550	12.065 0.4750	-5.3 -0.21	1.3 0.05	26.0 1.02	27.5 1.08	1.3 0.05	42.5 1.67	40.0 1.57	0.5 0.02	0.5 0.02	8.2	7.4	0.0480	0.12 0.27
11.176 0.4400	8.636 0.3400	-1.8 -0.07	1.3 0.05	26.0 1.02	27.5 1.08	1.3 0.05	39.5 1.56	36.5 1.44	-0.2 -0.01	1.2 0.05	4.7	8.6	0.0431	0.06 0.15
14.260 0.5614	9.525 0.3750	-2.8 -0.11	1.3 0.05	27.0 1.06	28.5 1.12	1.0 0.04	47.0 1.85	44.5 1.75	0.2 0.01	1.5 0.06	7.6	7.1	0.0509	0.12 0.28
14.260 0.5614	9.525 0.3750	-2.8 -0.11	1.5 0.06	27.0 1.06	29.0 1.14	1.0 0.04	47.0 1.85	44.5 1.75	0.2 0.01	1.5 0.06	7.6	7.1	0.0509	0.12 0.28
18.288 0.7200	13.970 0.5500	-6.4 -0.25	1.3 0.05	26.5 1.04	28.5 1.12	1.3 0.05	46.0 1.81	44.0 1.73	0.3 0.01	1.2 0.05	9.1	5.6	0.0479	0.16 0.36
18.288 0.7200	13.970 0.5500	-6.4 -0.25	0.4 0.02	26.5 1.04	26.5 1.04	1.3 0.05	46.0 1.81	44.0 1.73	0.3 0.01	1.2 0.05	9.1	5.6	0.0479	0.16 0.36

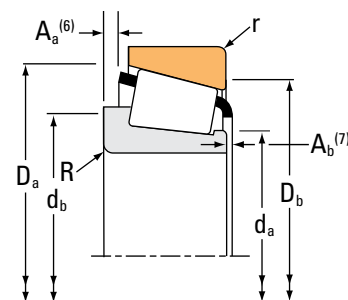
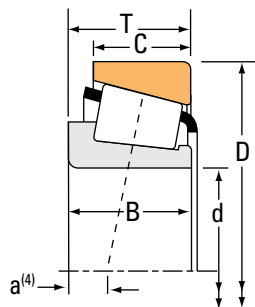
(4) Negative value indicates effective center inside cone (inner-ring) backface.
 (5) These maximum fillet radii will be cleared by the bearing corners.
 (6) Negative value indicates cage extends beyond cone (inner-ring) backface.
 (7) Negative value indicates cage that does not extend beyond cone (inner-ring) front face.
 (*) Contact your Timken engineer for details.

Continued on next page.

TAPERED ROLLER BEARINGS

SINGLE-ROW • TYPE TS

TYPE TS



Bearing Dimensions			Load Ratings							Part Number		
Bore d	O.D. D	Width T	Dynamic ⁽¹⁾ C ₁		Factors ⁽²⁾ e Y		Dynamic ⁽³⁾ C ₉₀ C _{a90}		Factors ⁽²⁾ K	Static C ₀	Inner	Outer
mm in.	mm in.	mm in.	N lbf				N lbf	N lbf		N lbf		
22.225 0.8750	51.994 2.0470	15.011 0.5910	29100 6540	0.40	1.49		7550 1700	5190 1170	1.45	29600 6650	07087	07204
22.225 0.8750	52.000 2.0472	15.011 0.5910	29100 6540	0.40	1.49		7550 1700	5190 1170	1.45	29600 6650	07087X	07205
22.225 0.8750	52.388 2.0625	19.368 0.7625	47900 10800	0.29	2.05		12400 2790	6200 1390	2.00	48300 10900	1380	1328
22.225 0.8750	53.975 2.1250	19.368 0.7625	47900 10800	0.29	2.05		12400 2790	6200 1390	2.00	48300 10900	1380	1329
22.225 0.8750	53.975 2.1250	19.368 0.7625	45400 10200	0.31	1.95		11800 2650	6200 1390	1.90	45300 10200	1755	1730
22.225 0.8750	56.896 2.2400	19.368 0.7625	45400 10200	0.31	1.95		11800 2650	6200 1390	1.90	45300 10200	1755	1729
22.225 0.8750	56.896 2.2400	19.368 0.7625	45400 10200	0.31	1.95		11800 2650	6200 1390	1.90	45300 10200	1755	1729X
22.225 0.8750	57.150 2.2500	19.845 0.7813	48400 10900	0.33	1.82		12500 2820	7080 1590	1.77	50200 11300	1975	1922
22.225 0.8750	57.150 2.2500	22.225 0.8750	55300 12400	0.35	1.73		14300 3230	8510 1910	1.69	55100 12400	1280	1220
22.225 0.8750	58.738 2.3125	19.050 0.7500	48400 10900	0.33	1.82		12500 2820	7080 1590	1.77	50200 11300	1975	1932
22.225 0.8750	60.325 2.3750	19.845 0.7813	48400 10900	0.33	1.82		12500 2820	7080 1590	1.77	50200 11300	1975	1931
22.225 0.8750	61.912 2.4375	36.512 1.4375	88600 19900	0.28	2.13		23000 5160	11100 2500	2.07	89800 20200	3655	3620
22.225 0.8750	62.000 2.4409	17.983 0.7080	48200 10800	0.24	2.48		12500 2810	5170 1160	2.42	49200 11100	246X	242
22.225 0.8750	66.421 2.6150	23.813 0.9375	76600 17200	0.25	2.36		19900 4470	8640 1940	2.30	81700 18400	2684	2631
22.606 0.8900	47.000 1.8504	15.500 0.6102	35100 7900	0.47	1.27		9110 2050	7380 1660	1.24	33000 7420	LM72849	LM72810
23.812 0.9375	50.005 1.9687	13.495 0.5313	29100 6540	0.40	1.49		7550 1700	5190 1170	1.45	29600 6650	07093	07196
23.812 0.9375	50.292 1.9800	14.224 0.5600	35600 8010	0.37	1.60		9230 2080	5910 1330	1.56	32900 7400	L44640	L44610

⁽¹⁾Based on 1 x 10⁶ revolutions L₁₀ life, for the ISO life-calculation method.

⁽²⁾Consult your Timken engineer for instructions on use or review the Timken Engineering Manual on timken.com/catalogs.

⁽³⁾Based on 90 x 10⁶ revolutions L₁₀ life, for The Timken Company life-calculation method. C₉₀ and C_{a90} are radial and thrust values.

Bearing Dimensions											Geometry Factors			Bearing Weight
Width B	Width C	Eff. Ctr. a ⁽⁴⁾	Shaft			Housing			Cage		G ₁	G ₂	C _g	
			Max Shaft Fillet Radius R ⁽⁵⁾	Backing Shoulder Dia. d _a	Shoulder Dia. d _b	Max Housing Fillet Radius r ⁽⁵⁾	Backing Shoulder Dia. D _a	Shoulder Dia. D _b	A _a ⁽⁶⁾	A _b ⁽⁷⁾				
mm in.	mm in.	mm in.	mm in.	mm in.	mm in.	mm in.	mm in.	mm in.	mm in.	mm in.				kg lbs.
14.260 0.5614	12.700 0.5000	-2.8 -0.11	1.3 0.05	27.0 1.06	28.5 1.12	1.3 0.05	48.0 1.89	45.0 1.77	0.2 0.01	1.5 0.06	7.6	7.1	0.0509	0.15 0.34
14.260 0.5614	12.700 0.5000	-2.8 -0.11	1.5 0.06	27.0 1.06	29.0 1.14	2.0 0.08	48.0 1.89	44.5 1.75	0.2 0.01	1.5 0.06	7.6	7.1	0.0509	0.15 0.34
20.168 0.7940	14.288 0.5625	-7.6 -0.30	1.5 0.06	27.0 1.06	29.5 1.16	1.5 0.06	48.5 1.91	45.0 1.77	1.3 0.05	1.1 0.05	10.3	5.2	0.0508	0.20 0.45
20.168 0.7940	14.288 0.5625	-7.6 -0.30	1.5 0.06	27.0 1.06	29.5 1.16	1.5 0.06	49.0 1.93	46.0 1.81	1.3 0.05	1.1 0.05	10.3	5.2	0.0508	0.21 0.48
19.837 0.7810	15.875 0.6250	-6.9 -0.27	1.3 0.05	27.5 1.08	29.0 1.14	0.8 0.03	50.0 1.97	48.5 1.91	1.8 0.07	0.4 0.02	10.6	5.4	0.0521	0.22 0.49
19.837 0.7810	15.875 0.6250	-6.9 -0.27	1.3 0.05	27.5 1.08	29.0 1.14	1.3 0.05	51.0 2.01	49.0 1.93	1.8 0.07	0.4 0.02	10.6	5.4	0.0521	0.25 0.56
19.837 0.7810	15.875 0.6250	-6.9 -0.27	1.3 0.05	27.5 1.08	29.0 1.14	1.5 0.06	51.0 2.01	49.0 1.93	1.8 0.07	0.4 0.02	10.6	5.4	0.0521	0.25 0.55
19.355 0.7620	15.875 0.6250	-5.8 -0.23	0.8 0.03	29.5 1.16	30.5 1.20	1.5 0.06	53.5 2.11	51.0 2.01	0.7 0.03	1.2 0.05	12.5	6.3	0.0565	0.26 0.57
22.225 0.8750	17.462 0.6875	-6.9 -0.27	0.8 0.03	29.0 1.14	29.5 1.16	1.5 0.06	52.0 2.05	49.0 1.93	* *	* *	11.4	5.5	0.0556	0.28 0.63
19.355 0.7620	15.080 0.5937	-5.8 -0.23	0.8 0.03	29.5 1.16	30.5 1.20	1.3 0.05	54.0 2.13	52.0 2.05	0.7 0.03	1.2 0.05	12.5	6.3	0.0565	0.27 0.60
19.355 0.7620	15.875 0.6250	-5.8 -0.23	0.8 0.03	29.5 1.16	30.5 1.20	1.3 0.05	55.0 2.17	52.0 2.05	0.7 0.03	1.2 0.05	12.5	6.3	0.0565	0.29 0.65
38.354 1.5100	23.812 0.9375	-19.8 -0.78	0.3 0.01	30.5 1.20	30.5 1.20	3.3 0.13	58.0 2.27	52.0 2.05	9.8 0.38	0.2 0.01	17.0	6.4	0.0592	0.52 1.12
19.000 0.7480	16.002 0.6300	-6.1 -0.24	3.5 0.14	30.0 1.18	34.5 1.36	2.0 0.08	57.0 2.24	55.0 2.17	0.0 0.00	0.8 0.03	12.8	8.2	0.0509	0.29 0.63
25.433 1.0013	19.050 0.7500	-9.4 -0.37	1.5 0.06	32.0 1.26	34.0 1.34	1.3 0.05	60.0 2.36	58.0 2.28	0.7 0.03	0.8 0.04	19.3	8.0	0.0598	0.46 1.02
15.500 0.6102	12.000 0.4724	-3.0 -0.12	1.5 0.06	28.0 1.10	30.0 1.18	1.0 0.04	44.0 1.73	40.5 1.59	0.6 0.02	0.9 0.04	7.5	9.0	0.0538	0.13 0.28
14.260 0.5614	9.525 0.3750	-2.8 -0.11	1.5 0.06	28.5 1.12	30.5 1.20	1.0 0.04	47.0 1.85	44.5 1.75	0.2 0.01	1.5 0.06	7.6	7.1	0.0509	0.12 0.27
14.732 0.5800	10.668 0.4200	-3.3 -0.13	1.5 0.06	28.5 1.12	30.5 1.20	1.3 0.05	47.0 1.85	44.5 1.75	0.8 0.03	0.6 0.03	8.9	8.9	0.0526	0.14 0.29

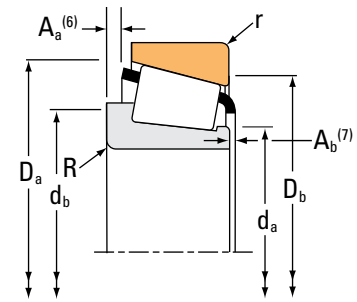
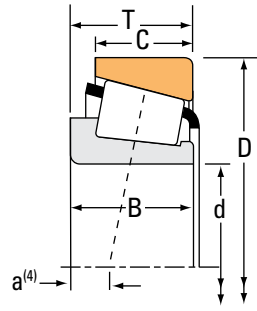
(4) Negative value indicates effective center inside cone (inner-ring) backface.
 (5) These maximum fillet radii will be cleared by the bearing corners.
 (6) Negative value indicates cage extends beyond cone (inner-ring) backface.
 (7) Negative value indicates cage that does not extend beyond cone (inner-ring) front face.
 (*) Contact your Timken engineer for details.

Continued on next page.

TAPERED ROLLER BEARINGS

SINGLE-ROW • TYPE TS

TYPE TS



Bearing Dimensions			Load Ratings						Part Number			
Bore d	O.D. D	Width T	Dynamic ⁽¹⁾		Factors ⁽²⁾		Dynamic ⁽³⁾		Static		Inner	Outer
			C ₁	e	Y	C ₉₀	C _{a90}	K	C ₀			
mm in.	mm in.	mm in.	N lbf			N lbf	N lbf		N lbf			
23.812 0.9375	50.800 2.0000	15.011 0.5910	29100 6540	0.40	1.49	7550 1700	5190 1170	1.45	29600 6650		07093	07210X
23.812 0.9375	51.994 2.0470	15.012 0.5910	29100 6540	0.40	1.49	7550 1700	5190 1170	1.45	29600 6650		07093	07204
23.812 0.9375	53.975 2.1250	19.368 0.7625	45400 10200	0.31	1.95	11800 2650	6200 1390	1.90	45300 10200		1779	1730
23.812 0.9375	56.896 2.2400	19.368 0.7625	45400 10200	0.31	1.95	11800 2650	6200 1390	1.90	45300 10200		1779	1729
23.812 0.9375	61.912 2.4375	28.575 1.1250	88600 19900	0.28	2.13	23000 5160	11100 2500	2.07	89800 20200		3659	3620
23.812 0.9375	65.088 2.5625	22.225 0.8750	54600 12300	0.73	0.82	14200 3180	17700 3990	0.80	55800 12500		23092	23256
23.812 0.9375	66.421 2.6150	23.812 0.9375	76600 17200	0.25	2.36	19900 4470	8640 1940	2.30	81700 18400		2685	2631
24.000 0.9449	55.000 2.1654	25.000 0.9842	79500 17900	0.35	1.70	20600 4630	12500 2800	1.65	71000 16000		JHM33449	JHM33410
24.384 0.9600	79.375 3.1250	25.400 1.0000	92000 20700	0.67	0.90	23900 5360	27300 6130	0.87	76200 17100		43096	43312
24.981 0.9835	50.005 1.9687	13.495 0.5313	29100 6540	0.40	1.49	7550 1700	5190 1170	1.45	29600 6650		07098	07196
24.981 0.9835	51.994 2.0470	15.011 0.5910	29100 6540	0.40	1.49	7550 1700	5190 1170	1.45	29600 6650		07098	07204
24.981 0.9835	52.000 2.0472	15.011 0.5910	29100 6540	0.40	1.49	7550 1700	5190 1170	1.45	29600 6650		07098	07205
24.981 0.9835	61.981 2.4402	16.002 0.6300	43200 9720	0.38	1.57	11200 2520	7340 1650	1.53	44100 9910		17098	17244A
24.981 0.9835	62.000 2.4409	16.002 0.6300	43200 9720	0.38	1.57	11200 2520	7340 1650	1.53	44100 9910		17098	17244
25.000 0.9843	50.005 1.9687	13.495 0.5313	29100 6540	0.40	1.49	7550 1700	5190 1170	1.45	29600 6650		07097	07196
25.000 0.9843	51.994 2.0470	15.011 0.5910	29100 6540	0.40	1.49	7550 1700	5190 1170	1.45	29600 6650		07097	07204
25.000 0.9843	52.000 2.0472	14.224 0.5600	35600 8010	0.37	1.60	9230 2080	5910 1330	1.56	32900 7400		JL44642A	JL44615

⁽¹⁾Based on 1×10^6 revolutions L_{10} life, for the ISO life-calculation method.

⁽²⁾Consult your Timken engineer for instructions on use or review the Timken Engineering Manual on timken.com/catalogs.

⁽³⁾Based on 90×10^6 revolutions L_{10} life, for The Timken Company life-calculation method. C_{90} and C_{a90} are radial and thrust values.

Bearing Dimensions											Geometry Factors			Bearing Weight
Width B	Width C	Eff. Ctr. a ⁽⁴⁾	Shaft			Housing			Cage		G ₁	G ₂	C _g	
			Max Shaft Fillet Radius R ⁽⁵⁾	Backing Shoulder Dia. d _a	Backing Shoulder Dia. d _b	Max Housing Fillet Radius r ⁽⁵⁾	Backing Shoulder Dia. D _a	Backing Shoulder Dia. D _b	A _a ⁽⁶⁾	A _b ⁽⁷⁾				
mm in.	mm in.	mm in.	mm in.	mm in.	mm in.	mm in.	mm in.	mm in.	mm in.	mm in.				kg lbs.
14.260 0.5614	12.700 0.5000	-2.8 -0.11	1.5 0.06	28.5 1.12	30.5 1.20	1.5 0.06	47.5 1.87	44.5 1.75	0.2 0.01	1.5 0.06	7.6	7.1	0.0509	0.14 0.30
14.260 0.5614	12.700 0.5000	-2.8 -0.11	1.5 0.06	28.5 1.12	30.5 1.20	1.3 0.05	48.0 1.89	45.0 1.77	0.2 0.01	1.5 0.06	7.6	7.1	0.0509	0.15 0.33
19.837 0.7810	15.875 0.6250	-6.9 -0.27	0.8 0.03	28.5 1.12	29.5 1.16	0.8 0.03	50.0 1.97	48.5 1.91	1.8 0.07	0.4 0.02	10.6	5.4	0.0521	0.21 0.47
19.837 0.7810	15.875 0.6250	-6.9 -0.27	0.8 0.03	28.5 1.12	29.5 1.16	1.3 0.05	51.0 2.01	49.0 1.93	1.8 0.07	0.4 0.02	10.6	5.4	0.0521	0.24 0.54
30.417 1.1975	23.812 0.9375	-11.9 -0.47	2.3 0.09	31.5 1.24	35.5 1.40	3.3 0.13	58.0 2.27	52.0 2.05	1.9 0.07	0.2 0.01	17.0	6.4	0.0592	0.44 0.96
21.463 0.8450	15.875 0.6250	-2.3 -0.09	1.5 0.06	34.5 1.36	38.5 1.52	1.5 0.06	63.0 2.48	53.0 2.09	3.7 0.14	2.1 0.08	11.3	6.6	0.0700	0.36 0.81
25.433 1.0013	19.050 0.7500	-9.4 -0.37	0.8 0.03	30.0 1.18	31.0 1.22	1.3 0.05	60.0 2.36	58.0 2.28	0.7 0.03	0.8 0.04	19.3	8.0	0.0598	0.44 0.99
25.000 0.9843	21.000 0.8268	-8.9 -0.35	2.0 0.08	30.0 1.18	35.0 1.38	2.0 0.08	52.0 2.05	47.0 1.85	0.4 0.01	1.8 0.07	13.3	5.8	0.0592	0.29 0.65
24.074 0.9478	17.462 0.6875	-2.0 -0.08	0.8 0.03	39.5 1.56	40.5 1.59	1.5 0.06	74.0 2.91	67.0 2.64	3.4 0.13	2.4 0.10	16.8	7.6	0.0774	0.65 1.42
14.260 0.5614	9.525 0.3750	-2.8 -0.11	1.5 0.06	29.0 1.14	31.0 1.22	1.0 0.04	47.0 1.85	44.5 1.75	0.2 0.01	1.5 0.06	7.6	7.1	0.0509	0.11 0.26
14.260 0.5614	12.700 0.5000	-2.8 -0.11	1.5 0.06	29.0 1.14	31.0 1.22	1.3 0.05	48.0 1.89	45.0 1.77	0.2 0.01	1.5 0.06	7.6	7.1	0.0509	0.14 0.31
14.260 0.5614	12.700 0.5000	-2.8 -0.11	1.5 0.06	29.0 1.14	31.0 1.22	2.0 0.08	48.0 1.89	44.5 1.75	0.2 0.01	1.5 0.06	7.6	7.1	0.0509	0.14 0.31
16.566 0.6522	14.288 0.5625	-3.6 -0.14	1.5 0.06	30.5 1.20	33.0 1.30	1.5 0.06	57.0 2.24	54.0 2.13	0.2 0.01	1.9 0.08	11.8	7.5	0.0579	0.25 0.56
16.566 0.6522	14.288 0.5625	-3.6 -0.14	1.5 0.06	30.5 1.20	33.0 1.30	1.5 0.06	57.0 2.24	54.0 2.13	0.2 0.01	1.9 0.08	11.8	7.5	0.0579	0.27 0.60
14.260 0.5614	9.525 0.3750	-2.8 -0.11	1.5 0.06	29.0 1.14	31.0 1.22	1.0 0.04	47.0 1.85	44.5 1.75	0.2 0.01	1.5 0.06	7.6	7.1	0.0509	0.11 0.26
14.260 0.5614	12.700 0.5000	-2.8 -0.11	1.5 0.06	29.0 1.14	31.0 1.22	1.3 0.05	48.0 1.89	45.0 1.77	0.2 0.01	1.5 0.06	7.6	7.1	0.0509	0.14 0.31
14.732 0.5800	10.668 0.4200	-3.3 -0.13	1.3 0.05	30.0 1.18	32.0 1.26	1.3 0.05	48.0 1.89	45.5 1.79	0.8 0.03	0.6 0.03	8.9	8.9	0.0526	0.14 0.31

⁽⁴⁾Negative value indicates effective center inside cone (inner-ring) backface.

⁽⁵⁾These maximum fillet radii will be cleared by the bearing corners.

⁽⁶⁾Negative value indicates cage extends beyond cone (inner-ring) backface.

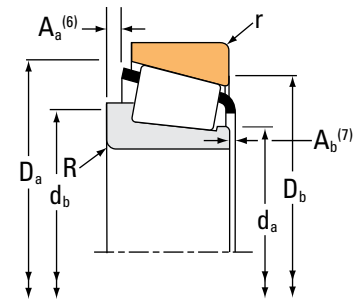
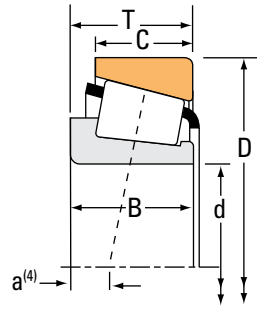
⁽⁷⁾Negative value indicates cage that does not extend beyond cone (inner-ring) front face.

Continued on next page.

TAPERED ROLLER BEARINGS

SINGLE-ROW • TYPE TS

TYPE TS



Bearing Dimensions			Load Ratings					Part Number			
Bore d	O.D. D	Width T	Dynamic ⁽¹⁾ C ₁	Factors ⁽²⁾ e	Y	Dynamic ⁽³⁾ C ₉₀	C _{a90}	Factors ⁽²⁾ K	Static C ₀	Inner	Outer
mm in.	mm in.	mm in.	N lbf			N lbf	N lbf		N lbf		
25.000 0.9843	52.000 2.0472	15.011 0.5910	29100 6540	0.40	1.49	7550 1700	5190 1170	1.45	29600 6650	07097	07205
25.000 0.9843	61.912 2.4375	21.018 0.8275	48200 10800	0.24	2.48	12500 2810	5170 1160	2.42	49200 11100	247	244X
25.400 1.0000	50.005 1.9687	13.495 0.5313	29100 6540	0.40	1.49	7550 1700	5190 1170	1.45	29600 6650	07100-S	07196
25.400 1.0000	50.292 1.9800	14.224 0.5600	35600 8010	0.37	1.60	9230 2080	5910 1330	1.56	32900 7400	L44643	L44610
25.400 1.0000	50.292 1.9800	14.224 0.5600	35600 8010	0.37	1.60	9230 2080	5910 1330	1.56	32900 7400	L44642	L44610
25.400 1.0000	50.800 2.0000	15.011 0.5910	29100 6540	0.40	1.49	7550 1700	5190 1170	1.45	29600 6650	07100-S	07210X
25.400 1.0000	50.800 2.0000	15.011 0.5910	29100 6540	0.40	1.49	7550 1700	5190 1170	1.45	29600 6650	07100-SA	07210X
25.400 1.0000	51.986 2.0467	15.011 0.5910	35600 8010	0.37	1.60	9230 2080	5910 1330	1.56	32900 7400	L44643	L44613
25.400 1.0000	52.000 2.0472	15.011 0.5910	29100 6540	0.40	1.49	7550 1700	5190 1170	1.45	29600 6650	07100-SA	07205
25.400 1.0000	52.000 2.0472	15.011 0.5910	29100 6540	0.40	1.49	7550 1700	5190 1170	1.45	29600 6650	07100-S	07205
25.400 1.0000	53.975 2.1250	19.368 0.7625	45400 10200	0.31	1.95	11800 2650	6200 1390	1.90	45300 10200	1780	1730
25.400 1.0000	56.896 2.2400	19.368 0.7625	45400 10200	0.31	1.95	11800 2650	6200 1390	1.90	45300 10200	1780	1729
25.400 1.0000	57.150 2.2500	17.462 0.6875	54500 12300	0.35	1.73	14100 3180	8380 1880	1.69	50100 11300	15578	15520
25.400 1.0000	57.150 2.2500	19.431 0.7650	48500 10900	0.55	1.10	12600 2830	11800 2640	1.07	52900 11900	M84548	M84510
25.400 1.0000	57.150 2.2500	19.845 0.7813	48400 10900	0.33	1.82	12500 2820	7080 1590	1.77	50200 11300	1986	1922
25.400 1.0000	57.150 2.2500	19.845 0.7813	48400 10900	0.33	1.82	12500 2820	7080 1590	1.77	50200 11300	1994X	1922
25.400 1.0000	57.150 2.2500	20.218 0.7960	45400 10200	0.31	1.95	11800 2650	6200 1390	1.90	45300 10200	1780	1738X

⁽¹⁾Based on 1×10^6 revolutions L_{10} life, for the ISO life-calculation method.

⁽²⁾Consult your Timken engineer for instructions on use or review the Timken Engineering Manual on timken.com/catalogs.

⁽³⁾Based on 90×10^6 revolutions L_{10} life, for The Timken Company life-calculation method. C_{90} and C_{a90} are radial and thrust values.

Bearing Dimensions											Geometry Factors			Bearing Weight
Width B	Width C	Eff. Ctr. a ⁽⁴⁾	Shaft			Housing			Cage		G ₁	G ₂	C _g	
			Max Shaft Fillet Radius R ⁽⁵⁾	Backing Shoulder Dia. d _a	Shoulder Dia. d _b	Max Housing Fillet Radius r ⁽⁵⁾	Backing Shoulder Dia. D _a	Shoulder Dia. D _b	A _a ⁽⁶⁾	A _b ⁽⁷⁾				
mm in.	mm in.	mm in.	mm in.	mm in.	mm in.	mm in.	mm in.	mm in.	mm in.	mm in.				kg lbs.
14.260 0.5614	12.700 0.5000	-2.8 -0.11	1.5 0.06	29.0 1.14	31.0 1.22	2.0 0.08	48.0 1.89	44.5 1.75	0.2 0.01	1.5 0.06	7.6	7.1	0.0509	0.14 0.31
19.000 0.7480	17.462 0.6875	-6.1 -0.24	2.0 0.08	30.0 1.18	33.5 1.32	3.3 0.13	57.0 2.24	52.0 2.05	0.0 0.00	0.8 0.03	12.8	8.2	0.0509	0.28 0.63
14.260 0.5614	9.525 0.3750	-2.8 -0.11	1.5 0.06	29.5 1.16	31.5 1.24	1.0 0.04	47.0 1.85	44.5 1.75	0.2 0.01	1.5 0.06	7.6	7.1	0.0509	0.11 0.25
14.732 0.5800	10.668 0.4200	-3.3 -0.13	1.3 0.05	30.0 1.18	32.0 1.26	1.3 0.05	47.0 1.85	44.5 1.75	0.7 0.03	0.6 0.03	8.9	8.9	0.0526	0.13 0.28
14.732 0.5800	10.668 0.4200	-3.3 -0.13	3.5 0.14	29.5 1.16	36.0 1.42	1.3 0.05	47.0 1.85	44.5 1.75	0.8 0.03	0.6 0.03	8.9	8.9	0.0526	0.13 0.27
14.260 0.5614	12.700 0.5000	-2.8 -0.11	1.5 0.06	29.5 1.16	31.5 1.24	1.5 0.06	47.5 1.87	44.5 1.75	0.2 0.01	1.5 0.06	7.6	7.1	0.0509	0.13 0.29
14.260 0.5614	12.700 0.5000	-2.8 -0.11	3.3 0.13	29.5 1.16	35.0 1.38	1.5 0.06	47.5 1.87	44.5 1.75	0.2 0.01	1.5 0.06	7.6	7.1	0.0509	0.13 0.28
14.732 0.5800	12.700 0.5000	-3.3 -0.13	1.3 0.05	30.0 1.18	32.0 1.26	2.0 0.08	48.0 1.89	44.5 1.75	0.7 0.03	0.6 0.03	8.9	8.9	0.0526	0.15 0.32
14.260 0.5614	12.700 0.5000	-2.8 -0.11	3.3 0.13	29.5 1.16	35.0 1.38	2.0 0.08	48.0 1.89	44.5 1.75	0.2 0.01	1.5 0.06	7.6	7.1	0.0509	0.14 0.30
14.260 0.5614	12.700 0.5000	-2.8 -0.11	1.5 0.06	29.5 1.16	31.5 1.24	2.0 0.08	48.0 1.89	44.5 1.75	0.2 0.01	1.5 0.06	7.6	7.1	0.0509	0.14 0.31
19.837 0.7810	15.875 0.6250	-6.9 -0.27	0.8 0.03	30.0 1.18	30.5 1.20	0.8 0.03	50.0 1.97	48.5 1.91	1.8 0.07	0.4 0.02	10.6	5.4	0.0521	0.20 0.45
19.837 0.7810	15.875 0.6250	-6.9 -0.27	0.8 0.03	30.0 1.18	30.5 1.20	1.3 0.05	51.0 2.01	49.0 1.93	1.8 0.07	0.4 0.02	10.6	5.4	0.0521	0.23 0.52
17.462 0.6875	13.495 0.5313	-5.1 -0.20	1.3 0.05	30.5 1.20	32.5 1.28	1.5 0.06	53.0 2.09	51.0 2.01	0.5 0.02	1.9 0.08	12.7	10.3	0.0577	0.22 0.48
19.431 0.7650	14.732 0.5800	-3.0 -0.12	1.5 0.06	33.0 1.30	38.5 1.52	1.5 0.06	54.0 2.13	48.5 1.91	1.1 0.04	1.3 0.05	11.3	7.4	0.0644	0.25 0.53
19.355 0.7620	15.875 0.6250	-5.8 -0.23	1.3 0.05	32.0 1.26	34.0 1.34	1.5 0.06	53.5 2.11	51.0 2.01	0.7 0.03	1.2 0.05	12.5	6.3	0.0565	0.25 0.53
19.355 0.7620	15.875 0.6250	-5.8 -0.23	3.5 0.14	30.5 1.20	37.0 1.46	1.5 0.06	53.5 2.11	51.0 2.01	0.7 0.03	1.2 0.05	12.5	6.3	0.0565	0.24 0.52
19.837 0.7810	17.550 0.6910	-6.9 -0.27	0.8 0.03	30.0 1.18	30.5 1.20	2.3 0.09	51.0 2.01	48.5 1.91	1.8 0.07	0.4 0.02	10.6	5.4	0.0521	0.25 0.55

⁽⁴⁾Negative value indicates effective center inside cone (inner-ring) backface.

⁽⁵⁾These maximum fillet radii will be cleared by the bearing corners.

⁽⁶⁾Negative value indicates cage extends beyond cone (inner-ring) backface.

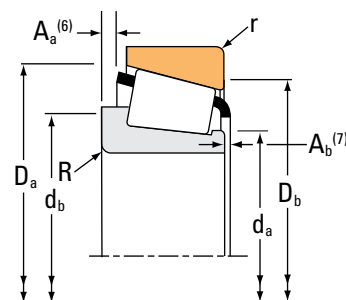
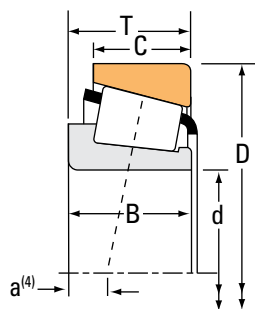
⁽⁷⁾Negative value indicates cage that does not extend beyond cone (inner-ring) front face.

Continued on next page.

TAPERED ROLLER BEARINGS

SINGLE-ROW • TYPE TS

TYPE TS



Bearing Dimensions			Load Ratings						Part Number				
Bore d	O.D. D	Width T	Dynamic ⁽¹⁾		Factors ⁽²⁾		Dynamic ⁽³⁾		Factors ⁽²⁾		Static C ₀	Inner	Outer
			C ₁	e	Y	C ₉₀	C _{a90}	K	N	N			
mm in.	mm in.	mm in.	N lbf			N lbf	N lbf		N lbf				
25.400 1.0000	58.738 2.3125	19.050 0.7500	48400 10900	0.33	1.82	12500 2820	7080 1590	1.77	50200 11300		1986	1932	
25.400 1.0000	59.530 2.3437	23.368 0.9200	58100 13100	0.55	1.10	15100 3390	14100 3170	1.07	63300 14200		M84249	M84210	
25.400 1.0000	60.325 2.3750	19.842 0.7812	54500 12300	0.35	1.73	14100 3180	8380 1880	1.69	50100 11300		15578	15523	
25.400 1.0000	60.325 2.3750	19.845 0.7813	48400 10900	0.33	1.82	12500 2820	7080 1590	1.77	50200 11300		1986	1931	
25.400 1.0000	60.325 2.3750	19.845 0.7813	48400 10900	0.33	1.82	12500 2820	7080 1590	1.77	50200 11300		1994X	1931	
25.400 1.0000	62.000 2.4409	18.161 0.7150	59900 13500	0.35	1.71	15500 3490	9310 2090	1.67	53900 12100		15100-SR	15245	
25.400 1.0000	62.000 2.4409	19.050 0.7500	59900 13500	0.35	1.71	15500 3490	9310 2090	1.67	53900 12100		15101	15245	
25.400 1.0000	62.000 2.4409	19.050 0.7500	59900 13500	0.35	1.71	15500 3490	9310 2090	1.67	53900 12100		15100	15245	
25.400 1.0000	62.000 2.4409	19.050 0.7500	59900 13500	0.35	1.71	15500 3490	9310 2090	1.67	53900 12100		15102	15245	
25.400 1.0000	62.000 2.4409	20.638 0.8125	59900 13500	0.35	1.71	15500 3490	9310 2090	1.67	53900 12100		15100	15244	
25.400 1.0000	62.000 2.4409	20.638 0.8125	59900 13500	0.35	1.71	15500 3490	9310 2090	1.67	53900 12100		15101	15244	
25.400 1.0000	63.100 2.4843	23.812 0.9375	76600 17200	0.25	2.36	19900 4470	8640 1940	2.30	81700 18400		2687	2630	
25.400 1.0000	63.500 2.5000	20.638 0.8125	59900 13500	0.35	1.71	15500 3490	9310 2090	1.67	53900 12100		15100	15250	
25.400 1.0000	63.500 2.5000	20.638 0.8125	59900 13500	0.35	1.71	15500 3490	9310 2090	1.67	53900 12100		15101	15250	
25.400 1.0000	63.500 2.5000	20.638 0.8125	59900 13500	0.35	1.71	15500 3490	9310 2090	1.67	53900 12100		15101	15250X	
25.400 1.0000	63.500 2.5000	20.638 0.8125	59900 13500	0.35	1.71	15500 3490	9310 2090	1.67	53900 12100		15102	15250	
25.400 1.0000	63.500 2.5000	20.638 0.8125	54600 12300	0.73	0.82	14200 3180	17700 3990	0.80	55800 12500		23101X	23250X	

⁽¹⁾Based on 1 x 10⁶ revolutions L₁₀ life, for the ISO life-calculation method.

⁽²⁾Consult your Timken engineer for instructions on use or review the Timken Engineering Manual on timken.com/catalogs.

⁽³⁾Based on 90 x 10⁶ revolutions L₁₀ life, for The Timken Company life-calculation method. C₉₀ and C_{a90} are radial and thrust values.

Bearing Dimensions											Geometry Factors			Bearing Weight
Width B	Width C	Eff. Ctr. a ⁽⁴⁾	Shaft			Housing			Cage		G ₁	G ₂	C _g	
			Max Shaft Fillet Radius R ⁽⁵⁾	Backing Shoulder Dia. d _a	Shoulder Dia. d _b	Max Housing Fillet Radius r ⁽⁵⁾	Backing Shoulder Dia. D _a	Shoulder Dia. D _b	A _a ⁽⁶⁾	A _b ⁽⁷⁾				
mm in.	mm in.	mm in.	mm in.	mm in.	mm in.	mm in.	mm in.	mm in.	mm in.	mm in.				kg lbs.
19.355 0.7620	15.080 0.5937	-5.8 -0.23	1.3 0.05	32.0 1.26	34.0 1.34	1.3 0.05	54.0 2.13	52.0 2.05	0.7 0.03	1.2 0.05	12.5	6.3	0.0565	0.26 0.56
23.114 0.9100	18.288 0.7200	-5.1 -0.20	0.8 0.03	32.5 1.27	36.0 1.42	1.5 0.06	56.0 2.20	49.5 1.95	1.3 0.05	1.7 0.07	12.7	7.6	0.0670	0.33 0.71
17.462 0.6875	15.875 0.6250	-5.1 -0.20	1.3 0.05	30.5 1.20	32.5 1.28	1.5 0.06	54.0 2.13	51.0 2.01	0.5 0.02	1.9 0.08	12.7	10.3	0.0577	0.27 0.60
19.355 0.7620	15.875 0.6250	-5.8 -0.23	1.3 0.05	32.0 1.26	34.0 1.34	1.3 0.05	55.0 2.17	52.0 2.05	0.7 0.03	1.2 0.05	12.5	6.3	0.0565	0.28 0.61
19.355 0.7620	15.875 0.6250	-5.8 -0.23	3.5 0.14	30.5 1.20	37.0 1.46	1.3 0.05	55.0 2.17	52.0 2.05	0.7 0.03	1.2 0.05	12.5	6.3	0.0565	0.27 0.60
19.050 0.7500	14.288 0.5625	-4.8 -0.19	1.3 0.05	32.5 1.28	33.5 1.32	1.3 0.05	58.0 2.28	55.0 2.17	0.3 0.01	1.8 0.07	14.6	10.0	0.0606	0.29 0.63
20.638 0.8125	14.288 0.5625	-5.8 -0.23	0.8 0.03	31.5 1.24	32.5 1.28	1.3 0.05	58.0 2.28	55.0 2.17	1.2 0.04	1.1 0.05	14.6	10.0	0.0606	0.30 0.65
20.638 0.8125	14.288 0.5625	-5.8 -0.23	3.5 0.14	31.5 1.24	38.0 1.50	1.3 0.05	58.0 2.28	55.0 2.17	1.2 0.04	1.1 0.05	14.6	10.0	0.0606	0.29 0.65
20.638 0.8125	14.288 0.5625	-5.8 -0.23	1.5 0.06	31.5 1.24	34.0 1.34	1.3 0.05	58.0 2.28	55.0 2.17	1.2 0.04	1.1 0.05	14.6	10.0	0.0606	0.30 0.65
20.638 0.8125	15.875 0.6250	-5.8 -0.23	3.5 0.14	31.5 1.24	38.0 1.50	1.3 0.05	58.0 2.28	55.0 2.17	1.2 0.04	1.1 0.05	14.6	10.0	0.0606	0.30 0.67
20.638 0.8125	15.875 0.6250	-5.8 -0.23	0.8 0.03	31.5 1.24	32.5 1.28	1.3 0.05	58.0 2.28	55.0 2.17	1.2 0.04	1.1 0.05	14.6	10.0	0.0606	0.31 0.68
25.433 1.0013	19.050 0.7500	-9.4 -0.37	1.3 0.05	31.5 1.24	33.5 1.32	0.8 0.03	59.0 2.32	57.0 2.24	0.7 0.03	0.8 0.04	19.3	8.0	0.0598	0.38 0.86
20.638 0.8125	15.875 0.6250	-5.8 -0.23	3.5 0.14	31.5 1.24	38.0 1.50	1.3 0.05	59.0 2.32	56.0 2.20	1.2 0.04	1.1 0.05	14.6	10.0	0.0606	0.32 0.72
20.638 0.8125	15.875 0.6250	-5.8 -0.23	0.8 0.03	31.5 1.24	32.5 1.28	1.3 0.05	59.0 2.32	56.0 2.20	1.2 0.04	1.1 0.05	14.6	10.0	0.0606	0.33 0.72
20.638 0.8125	15.875 0.6250	-5.8 -0.23	0.8 0.03	31.5 1.24	32.5 1.28	1.5 0.06	59.0 2.32	55.0 2.17	1.2 0.04	1.1 0.05	14.6	10.0	0.0606	0.33 0.72
20.638 0.8125	15.875 0.6250	-5.8 -0.23	1.5 0.06	31.5 1.24	34.0 1.34	1.3 0.05	59.0 2.32	56.0 2.20	1.2 0.04	1.1 0.05	14.6	10.0	0.0606	0.33 0.72
20.650 0.8130	14.681 0.5780	-1.3 -0.05	2.3 0.09	34.6 1.36	40.5 1.59	2.3 0.09	60.0 2.36	52.0 2.05	2.6 0.10	1.8 0.07	11.3	6.6	0.0700	0.31 0.70

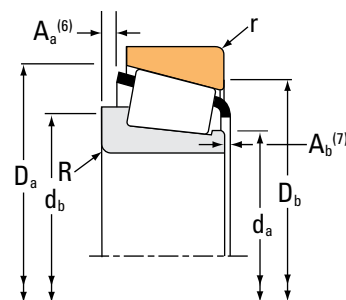
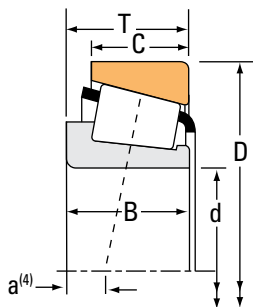
(4) Negative value indicates effective center inside cone (inner-ring) backface.
 (5) These maximum fillet radii will be cleared by the bearing corners.
 (6) Negative value indicates cage extends beyond cone (inner-ring) backface.
 (7) Negative value indicates cage that does not extend beyond cone (inner-ring) front face.

Continued on next page.

TAPERED ROLLER BEARINGS

SINGLE-ROW • TYPE TS

TYPE TS



Bearing Dimensions			Load Ratings					Part Number				
Bore d	O.D. D	Width T	Dynamic ⁽¹⁾		Factors ⁽²⁾		Dynamic ⁽³⁾		Static		Inner	Outer
			C ₁	e	Y	C ₉₀	C _{a90}	K	C ₀			
mm in.	mm in.	mm in.	N lbf			N lbf	N lbf		N lbf			
25.400 1.0000	63.500 2.5000	20.638 0.8125	59900 13500	0.35	1.71	15500 3490	9310 2090	1.67	53900 12100		15100-S	15250X
25.400 1.0000	65.088 2.5625	22.225 0.8750	54600 12300	0.73	0.82	14200 3180	17700 3990	0.80	55800 12500		23100	23256
25.400 1.0000	66.421 2.6150	23.812 0.9375	76600 17200	0.25	2.36	19900 4470	8640 1940	2.30	81700 18400		2687	2631
25.400 1.0000	68.262 2.6875	22.225 0.8750	67600 15200	0.34	1.77	17500 3940	10200 2290	1.72	73300 16500		2473	2420
25.400 1.0000	68.262 2.6875	22.225 0.8750	63800 14300	0.42	1.44	16500 3720	11800 2650	1.40	70200 15800		02473	02420
25.400 1.0000	68.262 2.6875	22.225 0.8750	59600 13400	0.55	1.10	15500 3470	14400 3250	1.07	77400 17400		M88036	M88010
25.400 1.0000	69.723 2.7450	19.050 0.7500	58800 13200	0.36	1.67	15200 3420	9390 2110	1.62	60100 13500		26100	26274
25.400 1.0000	72.233 2.8438	25.400 1.0000	76800 17300	0.55	1.10	19900 4480	18600 4180	1.07	94200 21200		HM88630	HM88610A
25.400 1.0000	72.233 2.8438	25.400 1.0000	76800 17300	0.55	1.10	19900 4480	18600 4180	1.07	94200 21200		HM88630	HM88610
25.400 1.0000	72.625 2.8593	24.608 0.9688	82600 18600	0.60	1.00	21400 4820	22100 4960	0.97	64100 14400		41100	41286
25.400 1.0000	72.625 2.8593	30.162 1.1875	94800 21300	0.33	1.80	24600 5520	14000 3140	1.76	102000 22800		3189	3120
25.400 1.0000	73.025 2.8750	26.543 1.0450	76800 17300	0.55	1.10	19900 4480	18600 4180	1.07	94200 21200		HM88630	HM88612
25.987 1.0231	51.986 2.0467	15.011 0.5910	35600 8010	0.37	1.60	9230 2080	5910 1330	1.56	32900 7400		L44645	L44613
25.987 1.0231	57.150 2.2500	17.462 0.6875	46000 10300	0.35	1.73	11900 2680	7070 1590	1.69	50100 11300		15579X	15520
26.157 1.0298	61.912 2.4375	19.050 0.7500	59900 13500	0.35	1.71	15500 3490	9310 2090	1.67	53900 12100		15103	15243
26.157 1.0298	62.000 2.4409	19.050 0.7500	59900 13500	0.35	1.71	15500 3490	9310 2090	1.67	53900 12100		15103	15245
26.162 1.0300	61.912 2.4375	19.050 0.7500	59900 13500	0.35	1.71	15500 3490	9310 2090	1.67	53900 12100		15103-S	15243

⁽¹⁾Based on 1×10^6 revolutions L_{10} life, for the ISO life-calculation method.

⁽²⁾Consult your Timken engineer for instructions on use or review the Timken Engineering Manual on timken.com/catalogs.

⁽³⁾Based on 90×10^6 revolutions L_{10} life, for The Timken Company life-calculation method. C_{90} and C_{a90} are radial and thrust values.

Bearing Dimensions											Geometry Factors			Bearing Weight
Width B	Width C	Eff. Ctr. a ⁽⁴⁾	Shaft			Housing			Cage		G ₁	G ₂	C _g	
			Max Shaft Fillet Radius R ⁽⁵⁾	Backing Shoulder Dia. d _a	Shoulder Dia. d _b	Max Housing Fillet Radius r ⁽⁵⁾	Backing Shoulder Dia. D _a	Shoulder Dia. D _b	A _a ⁽⁶⁾	A _b ⁽⁷⁾				
mm in.	mm in.	mm in.	mm in.	mm in.	mm in.	mm in.	mm in.	mm in.	mm in.	mm in.				kg lbs.
20.638 0.8125	15.875 0.6250	-5.8 -0.23	1.3 0.05	31.5 1.24	33.5 1.32	1.5 0.06	59.0 2.32	55.0 2.17	1.2 0.04	1.1 0.05	14.6	10.0	0.0606	0.33 0.72
21.463 0.8450	15.875 0.6250	-2.3 -0.09	1.5 0.06	34.5 1.36	39.0 1.54	1.5 0.06	63.0 2.48	53.0 2.09	3.7 0.14	2.1 0.08	11.3	6.6	0.0700	0.35 0.79
25.433 1.0013	19.050 0.7500	-9.4 -0.37	1.3 0.05	31.5 1.24	33.5 1.32	1.3 0.05	60.0 2.36	58.0 2.28	0.7 0.03	0.8 0.04	19.3	8.0	0.0598	0.43 0.97
23.812 0.9375	17.462 0.6875	-6.6 -0.26	0.8 0.03	32.5 1.28	33.5 1.32	1.5 0.06	63.0 2.48	60.0 2.36	0.9 0.03	0.3 0.01	18.8	10.5	0.0652	0.44 0.96
22.225 0.8750	17.462 0.6875	-5.1 -0.20	0.8 0.03	33.5 1.32	34.5 1.36	1.5 0.06	63.0 2.48	59.0 2.32	1.1 0.04	0.9 0.04	17.5	8.5	0.0681	0.43 0.94
22.225 0.8750	17.462 0.6875	-2.8 -0.11	0.8 0.03	36.5 1.44	37.0 1.46	1.5 0.06	65.0 2.56	58.0 2.28	1.7 0.06	1.0 0.04	19.4	10.0	0.0771	0.44 0.97
18.923 0.7450	19.050 0.7500	-4.1 -0.16	1.5 0.06	32.5 1.28	34.5 1.36	1.5 0.06	64.9 2.56	61.0 2.40	0.5 0.02	1.1 0.05	16.1	10.1	0.0630	0.39 0.88
25.400 1.0000	19.842 0.7812	-4.6 -0.18	0.8 0.03	39.5 1.56	39.5 1.56	0.8 0.03	69.0 2.72	61.0 2.40	1.6 0.06	1.7 0.07	23.4	9.4	0.0822	0.58 1.29
25.400 1.0000	19.842 0.7812	-4.6 -0.18	0.8 0.03	39.5 1.56	39.5 1.56	2.3 0.09	69.0 2.72	60.0 2.36	1.6 0.06	1.7 0.07	23.4	9.4	0.0822	0.57 1.28
24.257 0.9550	17.462 0.6875	-4.1 -0.16	2.3 0.09	36.5 1.44	41.0 1.61	1.5 0.06	68.0 2.68	61.0 2.40	3.0 0.12	2.3 0.09	13.0	5.8	0.0686	0.50 1.09
29.997 1.1810	23.812 0.9375	-10.2 -0.40	0.8 0.03	35.0 1.38	35.5 1.40	3.3 0.13	67.0 2.64	61.0 2.40	* *	* *	23.4	8.8	0.0697	0.66 1.43
25.400 1.0000	20.985 0.8262	-4.6 -0.18	0.8 0.03	39.5 1.56	39.5 1.56	2.3 0.09	69.0 2.72	60.0 2.36	1.6 0.06	1.7 0.07	23.4	9.4	0.0822	0.61 1.35
14.732 0.5800	12.700 0.5000	-3.3 -0.13	3.5 0.14	30.0 1.18	36.5 1.44	2.0 0.08	48.0 1.89	44.5 1.75	0.8 0.03	0.6 0.03	8.9	8.9	0.0526	0.14 0.30
17.462 0.6875	13.495 0.5313	-5.1 -0.20	3.5 0.14	31.0 1.22	37.5 1.48	1.5 0.06	53.0 2.09	51.0 2.01	* *	* *	12.7	10.3	0.0577	0.21 0.46
20.638 0.8125	14.288 0.5625	-5.8 -0.23	0.8 0.03	32.5 1.28	33.0 1.30	2.0 0.08	58.0 2.28	54.0 2.13	1.2 0.04	1.1 0.05	14.6	10.0	0.0606	0.29 0.64
20.638 0.8125	14.288 0.5625	-5.8 -0.23	0.8 0.03	32.5 1.28	33.0 1.30	1.3 0.05	58.0 2.28	55.0 2.17	1.2 0.04	1.1 0.05	14.6	10.0	0.0606	0.29 0.64
19.939 0.7850	14.288 0.5625	-5.8 -0.23	0.8 0.03	33.5 1.32	33.5 1.32	2.0 0.08	58.0 2.28	54.0 2.13	1.2 0.04	1.7 0.07	14.6	10.0	0.0606	0.29 0.64

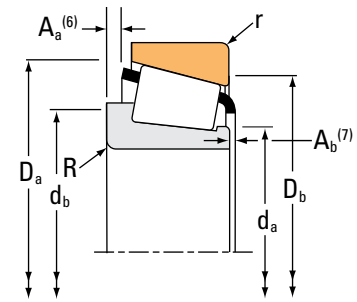
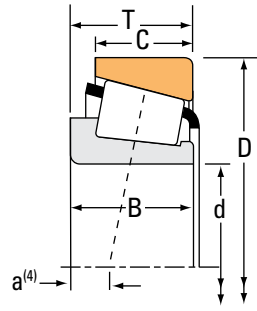
(4) Negative value indicates effective center inside cone (inner-ring) backface.
 (5) These maximum fillet radii will be cleared by the bearing corners.
 (6) Negative value indicates cage extends beyond cone (inner-ring) backface.
 (7) Negative value indicates cage that does not extend beyond cone (inner-ring) front face.
 (*) Contact your Timken engineer for details.

Continued on next page.

TAPERED ROLLER BEARINGS

SINGLE-ROW • TYPE TS

TYPE TS



Bearing Dimensions			Load Ratings						Part Number				
Bore d	O.D. D	Width T	Dynamic ⁽¹⁾		Factors ⁽²⁾		Dynamic ⁽³⁾		Factors ⁽²⁾		Static C ₀	Inner	Outer
			C ₁	e	Y	C ₉₀	C _{a90}	K	N	N			
mm in.	mm in.	mm in.	N lbf			N lbf	N lbf		N lbf		N lbf		
26.162 1.0300	66.421 2.6150	23.812 0.9375	76600 17200	0.25	2.36	19900 4470	8640 1940	2.30	81700 18400			2682	2631
26.975 1.0620	58.738 2.3125	19.050 0.7500	48400 10900	0.33	1.82	12500 2820	7080 1590	1.77	50200 11300			1987	1932
26.975 1.0620	60.325 2.3750	19.355 0.7620	48400 10900	0.33	1.82	12500 2820	7080 1590	1.77	50200 11300			1987	1931
26.987 1.0625	50.292 1.9800	14.224 0.5600	35600 8010	0.37	1.60	9230 2080	5910 1330	1.56	32900 7400			L44649	L44610
26.987 1.0625	51.986 2.0467	15.011 0.5910	35600 8010	0.37	1.60	9230 2080	5910 1330	1.56	32900 7400			L44649	L44613
26.987 1.0625	57.150 2.2500	17.462 0.6875	46000 10300	0.35	1.73	11900 2680	7070 1590	1.69	50100 11300			15580	15520
26.987 1.0625	57.150 2.2500	19.431 0.7650	48500 10900	0.55	1.10	12600 2830	11800 2640	1.07	52900 11900			M84549	M84510
26.987 1.0625	57.150 2.2500	19.845 0.7813	48400 10900	0.33	1.82	12500 2820	7080 1590	1.77	50200 11300			1997X	1922
26.987 1.0625	60.325 2.3750	19.842 0.7812	46000 10300	0.35	1.73	11900 2680	7070 1590	1.69	50100 11300			15580	15523
26.987 1.0625	62.000 2.4409	19.050 0.7500	59900 13500	0.35	1.71	15500 3490	9310 2090	1.67	53900 12100			15106	15245
26.987 1.0625	63.500 2.5000	20.638 0.8125	59900 13500	0.35	1.71	15500 3490	9310 2090	1.67	53900 12100			15106	15250X
26.987 1.0625	66.421 2.6150	23.812 0.9375	76600 17200	0.25	2.36	19900 4470	8640 1940	2.30	81700 18400			2688	2631
26.987 1.0625	72.625 2.8593	24.608 0.9688	82600 18600	0.60	1.00	21400 4820	22100 4960	0.97	64100 14400			41106	41286
27.000 1.0630	59.131 2.3280	15.875 0.6250	46700 10500	0.41	1.46	12100 2720	8550 1920	1.42	44600 10000			JLM67042	LM67010
27.987 1.1019	66.987 2.6373	20.500 0.8071	63800 14300	0.42	1.44	16500 3720	11800 2650	1.40	70200 15800			02473X	02419
28.000 1.1024	57.150 2.2500	17.462 0.6875	54500 12300	0.35	1.73	14100 3180	8380 1880	1.69	50100 11300			J15585	15520
28.575 1.1250	56.896 2.2400	19.845 0.7813	48400 10900	0.33	1.82	12500 2820	7080 1590	1.77	50200 11300			1985	1930

⁽¹⁾Based on 1 x 10⁶ revolutions L₁₀ life, for the ISO life-calculation method.

⁽²⁾Consult your Timken engineer for instructions on use or review the Timken Engineering Manual on timken.com/catalogs.

⁽³⁾Based on 90 x 10⁶ revolutions L₁₀ life, for The Timken Company life-calculation method. C₉₀ and C_{a90} are radial and thrust values.

Bearing Dimensions											Geometry Factors			Bearing Weight
Width B	Width C	Eff. Ctr. a ⁽⁴⁾	Shaft			Housing			Cage		G ₁	G ₂	C _g	
			Max Shaft Fillet Radius R ⁽⁵⁾	Backing Shoulder Dia. d _a	Backing Shoulder Dia. d _b	Max Housing Fillet Radius r ⁽⁵⁾	Backing Shoulder Dia. D _a	Backing Shoulder Dia. D _b	A _a ⁽⁶⁾	A _b ⁽⁷⁾				
mm in.	mm in.	mm in.	mm in.	mm in.	mm in.	mm in.	mm in.	mm in.	mm in.	mm in.				kg lbs.
25.433 1.0013	19.050 0.7500	-9.4 -0.37	1.5 0.06	32.0 1.26	34.5 1.36	1.3 0.05	60.0 2.36	58.0 2.28	0.7 0.03	0.8 0.04	19.3	8.0	0.0598	0.43 0.95
19.355 0.7620	15.080 0.5937	-5.8 -0.23	0.8 0.03	31.5 1.24	32.5 1.28	1.3 0.05	54.0 2.13	52.0 2.05	0.7 0.03	1.2 0.05	12.5	6.3	0.0565	0.25 0.54
19.355 0.7620	15.875 0.6250	-5.8 -0.23	0.8 0.03	31.5 1.24	32.5 1.28	1.3 0.05	55.0 2.17	52.0 2.05	0.7 0.03	1.2 0.05	12.5	6.3	0.0565	0.27 0.59
14.732 0.5800	10.668 0.4200	-3.3 -0.13	3.5 0.14	31.0 1.22	37.5 1.48	1.3 0.05	47.0 1.85	44.5 1.75	0.7 0.03	0.6 0.03	8.9	8.9	0.0526	0.12 0.26
14.732 0.5800	12.700 0.5000	-3.3 -0.13	3.5 0.14	31.0 1.22	37.5 1.48	2.0 0.08	48.0 1.89	44.5 1.75	0.7 0.03	0.6 0.03	8.9	8.9	0.0526	0.14 0.30
17.462 0.6875	13.495 0.5313	-5.1 -0.20	3.5 0.14	32.0 1.26	38.5 1.52	1.5 0.06	53.0 2.09	51.0 2.01	0.5 0.02	1.9 0.08	12.7	10.3	0.0577	0.21 0.45
19.431 0.7650	14.732 0.5800	-3.0 -0.12	1.5 0.06	33.0 1.30	38.5 1.52	1.5 0.06	54.0 2.13	48.5 1.91	1.1 0.04	1.3 0.05	11.3	7.4	0.0644	0.24 0.51
19.355 0.7620	15.875 0.6250	-5.8 -0.23	3.3 0.13	31.5 1.24	37.5 1.48	1.5 0.06	53.5 2.11	51.0 2.01	0.7 0.03	1.2 0.05	12.5	6.3	0.0565	0.23 0.50
17.462 0.6875	15.875 0.6250	-5.1 -0.20	3.5 0.14	32.0 1.26	38.5 1.52	1.5 0.06	54.0 2.13	51.0 2.01	0.5 0.02	1.9 0.08	12.7	10.3	0.0577	0.26 0.57
20.638 0.8125	14.288 0.5625	-5.8 -0.23	0.8 0.03	33.0 1.30	33.5 1.32	1.3 0.05	58.0 2.28	55.0 2.17	1.2 0.04	1.1 0.05	14.6	10.0	0.0606	0.29 0.63
20.638 0.8125	15.875 0.6250	-5.8 -0.23	0.8 0.03	33.0 1.30	33.5 1.32	1.5 0.06	59.0 2.32	55.0 2.17	1.2 0.04	1.1 0.05	14.6	10.0	0.0606	0.32 0.70
25.433 1.0013	19.050 0.7500	-9.4 -0.37	1.5 0.06	33.0 1.30	35.0 1.38	1.3 0.05	60.0 2.36	58.0 2.28	0.7 0.03	0.8 0.04	19.3	8.0	0.0598	0.42 0.94
24.257 0.9550	17.462 0.6875	-4.1 -0.16	2.3 0.09	36.5 1.44	42.0 1.65	1.5 0.06	68.0 2.68	61.0 2.40	3.0 0.12	2.3 0.09	13.0	5.8	0.0686	0.49 1.07
16.764 0.6600	11.811 0.4650	-3.0 -0.12	0.5 0.02	33.0 1.30	33.5 1.32	1.3 0.05	56.0 2.20	52.0 2.05	0.7 0.02	0.8 0.03	12.8	9.7	0.0612	0.21 0.47
20.500 0.8071	16.000 0.6299	-5.1 -0.20	0.8 0.03	35.5 1.40	36.5 1.44	1.5 0.06	62.0 2.44	59.0 2.32	1.1 0.04	2.7 0.11	17.5	8.5	0.0681	0.36 0.80
17.462 0.6875	13.495 0.5313	-5.1 -0.20	3.5 0.14	32.5 1.28	39.0 1.54	1.5 0.06	53.0 2.09	51.0 2.01	* *	* *	12.7	10.3	0.0577	0.20 0.44
19.355 0.7620	15.875 0.6250	-5.8 -0.23	0.8 0.03	33.5 1.32	34.0 1.34	0.8 0.03	54.0 2.11	51.0 2.01	0.7 0.03	1.2 0.05	12.5	6.3	0.0565	0.22 0.48

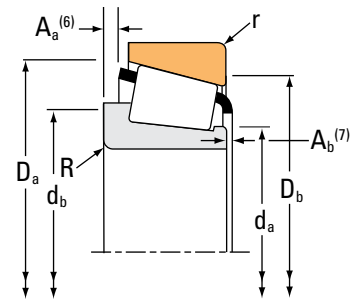
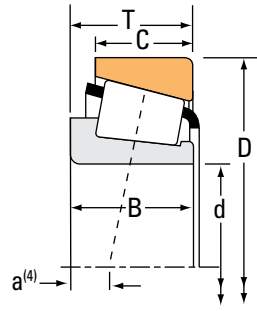
(4) Negative value indicates effective center inside cone (inner-ring) backface.
 (5) These maximum fillet radii will be cleared by the bearing corners.
 (6) Negative value indicates cage extends beyond cone (inner-ring) backface.
 (7) Negative value indicates cage that does not extend beyond cone (inner-ring) front face.
 (*) Contact your Timken engineer for details.

Continued on next page.

TAPERED ROLLER BEARINGS

SINGLE-ROW • TYPE TS

TYPE TS



Bearing Dimensions			Load Ratings						Part Number				
Bore d	O.D. D	Width T	Dynamic ⁽¹⁾		Factors ⁽²⁾		Dynamic ⁽³⁾		Factors ⁽²⁾		Static C ₀	Inner	Outer
			C ₁	e	Y	C ₉₀	C _{a90}	K	N	N			
mm in.	mm in.	mm in.	N lbf			N lbf	N lbf		N lbf				
28.575 1.1250	57.150 2.2500	17.462 0.6875	46000 10300	0.35	1.73	11900 2680	7070 1590	1.69	50100 11300		15590	15520	
28.575 1.1250	57.150 2.2500	19.845 0.7813	48400 10900	0.33	1.82	12500 2820	7080 1590	1.77	50200 11300		1985	1922	
28.575 1.1250	58.738 2.3125	19.050 0.7500	48400 10900	0.33	1.82	12500 2820	7080 1590	1.77	50200 11300		1985	1932	
28.575 1.1250	59.131 2.3280	15.875 0.6250	36500 8210	0.41	1.46	9460 2130	6680 1500	1.42	44600 10000		LM67043	LM67010	
28.575 1.1250	60.325 2.3750	19.845 0.7813	48400 10900	0.33	1.82	12500 2820	7080 1590	1.77	50200 11300		1985	1931	
28.575 1.1250	62.000 2.4409	19.050 0.7500	59900 13500	0.35	1.71	15500 3490	9310 2090	1.67	53900 12100		15113	15245	
28.575 1.1250	62.000 2.4409	19.050 0.7500	59900 13500	0.35	1.71	15500 3490	9310 2090	1.67	53900 12100		15112	15245	
28.575 1.1250	62.000 2.4409	20.638 0.8125	59900 13500	0.35	1.71	15500 3490	9310 2090	1.67	53900 12100		15112	15244	
28.575 1.1250	63.100 2.4843	23.812 0.9375	76600 17200	0.25	2.36	19900 4470	8640 1940	2.30	81700 18400		2689	2630	
28.575 1.1250	63.500 2.5000	20.638 0.8125	59900 13500	0.35	1.71	15500 3490	9310 2090	1.67	53900 12100		15112	15250	
28.575 1.1250	63.500 2.5000	20.638 0.8125	59900 13500	0.35	1.71	15500 3490	9310 2090	1.67	53900 12100		15113	15250	
28.575 1.1250	63.500 2.5000	20.638 0.8125	59900 13500	0.35	1.71	15500 3490	9310 2090	1.67	53900 12100		15112	15250X	
28.575 1.1250	64.292 2.5312	21.433 0.8438	60200 13500	0.55	1.10	15600 3510	14600 3280	1.07	71700 16100		M86647	M86610	
28.575 1.1250	66.421 2.6150	19.050 0.7500	55900 12600	0.34	1.77	14500 3260	8420 1890	1.72	55200 12400		24112	24261	
28.575 1.1250	66.421 2.6150	23.812 0.9375	76600 17200	0.25	2.36	19900 4470	8640 1940	2.30	81700 18400		2689	2631	
28.575 1.1250	68.262 2.6875	22.225 0.8750	67600 15200	0.34	1.77	17500 3940	10200 2290	1.72	73300 16500		2474	2420	
28.575 1.1250	68.262 2.6875	22.225 0.8750	63800 14300	0.42	1.44	16500 3720	11800 2650	1.40	70200 15800		02474	02420	

⁽¹⁾Based on 1 x 10⁶ revolutions L₁₀ life, for the ISO life-calculation method.

⁽²⁾Consult your Timken engineer for instructions on use or review the Timken Engineering Manual on timken.com/catalogs.

⁽³⁾Based on 90 x 10⁶ revolutions L₁₀ life, for The Timken Company life-calculation method. C₉₀ and C_{a90} are radial and thrust values.

Bearing Dimensions											Geometry Factors			Bearing Weight
Width B	Width C	Eff. Ctr. a ⁽⁴⁾	Shaft			Housing			Cage		G ₁	G ₂	C _g	
			Max Shaft Fillet Radius R ⁽⁵⁾	Backing Shoulder Dia. d _a	Backing Shoulder Dia. d _b	Max Housing Fillet Radius r ⁽⁵⁾	Backing Shoulder Dia. D _a	Backing Shoulder Dia. D _b	A _a ⁽⁶⁾	A _b ⁽⁷⁾				
mm in.	mm in.	mm in.	mm in.	mm in.	mm in.	mm in.	mm in.	mm in.	mm in.	mm in.				kg lbs.
17.462 0.6875	13.495 0.5313	-5.1 -0.20	3.5 0.14	33.5 1.32	39.5 1.56	1.5 0.06	53.0 2.09	51.0 2.01	0.5 0.02	1.9 0.08	12.7	10.3	0.0577	0.20 0.43
19.355 0.7620	15.875 0.6250	-5.8 -0.23	0.8 0.03	33.5 1.32	34.0 1.34	1.5 0.06	53.5 2.11	51.0 2.01	0.7 0.03	1.2 0.05	12.5	6.3	0.0565	0.23 0.49
19.355 0.7620	15.080 0.5937	-5.8 -0.23	0.8 0.03	33.5 1.32	34.0 1.34	1.3 0.05	54.0 2.13	52.0 2.05	0.7 0.03	1.2 0.05	12.5	6.3	0.0565	0.24 0.51
16.764 0.6600	11.811 0.4650	-3.0 -0.12	0.0 0.00	35.0 1.38	41.5 1.63	1.3 0.05	56.0 2.20	52.0 2.05	0.7 0.02	0.8 0.03	12.8	9.7	0.0612	0.20 0.44
19.355 0.7620	15.875 0.6250	-5.8 -0.23	0.8 0.03	33.5 1.32	34.0 1.34	1.3 0.05	55.0 2.17	52.0 2.05	0.7 0.03	1.2 0.05	12.5	6.3	0.0565	0.26 0.57
20.638 0.8125	14.288 0.5625	-5.8 -0.23	0.8 0.03	34.0 1.34	34.5 1.36	1.3 0.05	58.0 2.28	55.0 2.17	1.2 0.04	1.1 0.05	14.6	10.0	0.0606	0.28 0.61
20.638 0.8125	14.288 0.5625	-5.8 -0.23	3.5 0.14	34.0 1.34	40.0 1.57	1.3 0.05	58.0 2.28	55.0 2.17	1.2 0.04	1.1 0.05	14.6	10.0	0.0606	0.27 0.60
20.638 0.8125	15.875 0.6250	-5.8 -0.23	3.5 0.14	34.0 1.34	40.0 1.57	1.3 0.05	58.0 2.28	55.0 2.17	1.2 0.04	1.1 0.05	14.6	10.0	0.0606	0.28 0.62
25.433 1.0013	19.050 0.7500	-9.4 -0.37	1.3 0.05	36.0 1.42	37.5 1.48	0.8 0.03	59.0 2.32	57.0 2.24	0.7 0.03	0.8 0.04	19.3	8.0	0.0598	0.36 0.80
20.638 0.8125	15.875 0.6250	-5.8 -0.23	3.5 0.14	34.0 1.34	40.0 1.57	1.3 0.05	59.0 2.32	56.0 2.20	1.2 0.04	1.1 0.05	14.6	10.0	0.0606	0.30 0.67
20.638 0.8125	15.875 0.6250	-5.8 -0.23	0.8 0.03	34.0 1.34	34.5 1.36	1.3 0.05	59.0 2.32	56.0 2.20	1.2 0.04	1.1 0.05	14.6	10.0	0.0606	0.31 0.68
20.638 0.8125	15.875 0.6250	-5.8 -0.23	3.5 0.14	34.0 1.34	40.0 1.57	1.5 0.06	59.0 2.32	55.0 2.17	1.2 0.04	1.1 0.05	14.6	10.0	0.0606	0.30 0.67
21.433 0.8438	16.670 0.6563	-3.3 -0.13	1.5 0.06	31.0 1.50	40.0 1.57	1.5 0.06	60.0 2.36	54.0 2.13	1.3 0.05	1.3 0.05	16.8	7.4	0.0736	0.35 0.77
18.974 0.7470	15.875 0.6250	-4.8 -0.19	1.5 0.06	34.0 1.34	36.0 1.42	1.5 0.06	61.0 2.40	58.0 2.28	0.3 0.01	1.5 0.06	14.0	8.3	0.0589	0.31 0.69
25.433 1.0013	19.050 0.7500	-9.4 -0.37	1.3 0.05	36.0 1.42	37.5 1.48	1.3 0.05	60.0 2.36	58.0 2.28	0.7 0.03	0.8 0.04	19.3	8.0	0.0598	0.41 0.91
23.812 0.9375	17.462 0.6875	-6.6 -0.26	0.8 0.03	35.0 1.38	36.0 1.42	1.5 0.06	63.0 2.48	60.0 2.36	0.9 0.03	0.3 0.01	18.8	10.5	0.0652	0.42 0.90
22.225 0.8750	17.462 0.6875	-5.1 -0.20	0.8 0.03	36.0 1.42	36.5 1.44	1.5 0.06	63.0 2.48	59.0 2.32	1.1 0.04	0.9 0.04	17.5	8.5	0.0681	0.41 0.89

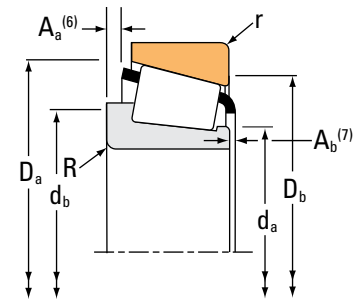
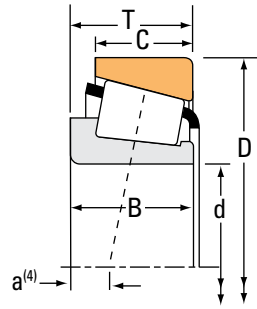
(4) Negative value indicates effective center inside cone (inner-ring) backface.
 (5) These maximum fillet radii will be cleared by the bearing corners.
 (6) Negative value indicates cage extends beyond cone (inner-ring) backface.
 (7) Negative value indicates cage that does not extend beyond cone (inner-ring) front face.

Continued on next page.

TAPERED ROLLER BEARINGS

SINGLE-ROW • TYPE TS

TYPE TS



Bearing Dimensions			Load Ratings						Part Number				
Bore d	O.D. D	Width T	Dynamic ⁽¹⁾		Factors ⁽²⁾		Dynamic ⁽³⁾		Factors ⁽²⁾		Static C ₀	Inner	Outer
			C ₁	e	Y	C ₉₀	C _{a90}	K	N	N			
mm in.	mm in.	mm in.	N lbf			N lbf	N lbf		N lbf				
28.575 1.1250	69.723 2.7450	19.050 0.7500	69600 15700	0.36	1.67	18100 4060	11100 2500	1.62	60100 13500		26112	26274	
28.575 1.1250	69.850 2.7500	23.812 0.9375	83700 18800	0.27	2.19	21700 4880	10200 2280	2.14	94400 21200		2578	2523	
28.575 1.1250	69.850 2.7500	23.812 0.9375	83700 18800	0.27	2.19	21700 4880	10200 2280	2.14	94400 21200		2578	2523-S	
28.575 1.1250	72.000 2.8346	19.000 0.7480	69600 15700	0.36	1.67	18100 4060	11100 2500	1.62	60100 13500		26112	26283	
28.575 1.1250	72.625 2.8593	24.608 0.9688	82600 18600	0.60	1.00	21400 4820	22100 4960	0.97	64100 14400		41125	41286	
28.575 1.1250	72.625 2.8593	24.608 0.9688	82600 18600	0.60	1.00	21400 4820	22100 4960	0.97	64100 14400		41126	41286	
28.575 1.1250	72.625 2.8593	30.162 1.1875	94800 21300	0.33	1.80	24600 5520	14000 3140	1.76	102000 22800		3192	3120	
28.575 1.1250	72.625 2.8593	30.162 1.1875	94800 21300	0.33	1.80	24600 5520	14000 3140	1.76	102000 22800		3198	3120	
28.575 1.1250	73.025 2.8750	22.225 0.8750	65700 14800	0.45	1.32	17000 3830	13200 2980	1.29	74900 16800		02872	02820	
28.575 1.1250	73.025 2.8750	22.225 0.8750	65700 14800	0.45	1.32	17000 3830	13200 2980	1.29	74900 16800		02872	02830	
28.575 1.1250	76.200 3.0000	19.000 0.7480	69600 15700	0.36	1.67	18100 4060	11100 2500	1.62	60100 13500		26112	26300	
28.575 1.1250	76.200 3.0000	30.162 1.1875	94800 21300	0.33	1.80	24600 5520	14000 3140	1.76	102000 22800		3198	3129	
28.575 1.1250	79.375 3.1250	25.400 1.0000	92000 20700	0.67	0.90	23900 5360	27300 6130	0.87	76200 17100		43112	43312	
29.000 1.1417	50.292 1.9800	14.224 0.5600	35500 7980	0.37	1.62	9200 2070	5820 1310	1.58	36200 8130		L45449	L45410	
29.367 1.1562	66.421 2.6150	23.812 0.9375	76600 17200	0.25	2.36	19900 4470	8640 1940	2.30	81700 18400		2691	2631	
29.367 1.1562	66.421 2.6150	23.812 0.9375	76600 17200	0.25	2.36	19900 4470	8640 1940	2.30	81700 18400		2690	2631	
29.987 1.1806	61.981 2.4402	16.002 0.6300	43200 9720	0.38	1.57	11200 2520	7340 1650	1.53	44100 9910		17118	17244A	

⁽¹⁾Based on 1 x 10⁶ revolutions L₁₀ life, for the ISO life-calculation method.

⁽²⁾Consult your Timken engineer for instructions on use or review the Timken Engineering Manual on timken.com/catalogs.

⁽³⁾Based on 90 x 10⁶ revolutions L₁₀ life, for The Timken Company life-calculation method. C₉₀ and C_{a90} are radial and thrust values.

Bearing Dimensions											Geometry Factors			Bearing Weight
Width B	Width C	Eff. Ctr. a ⁽⁴⁾	Shaft			Housing			Cage		G ₁	G ₂	C _g	
			Max Shaft Fillet Radius R ⁽⁵⁾	Backing Shoulder Dia. d _a	Shoulder Dia. d _b	Max Housing Fillet Radius r ⁽⁵⁾	Backing Shoulder Dia. D _a	Shoulder Dia. D _b	A _a ⁽⁶⁾	A _b ⁽⁷⁾				
mm in.	mm in.	mm in.	mm in.	mm in.	mm in.	mm in.	mm in.	mm in.	mm in.	mm in.				kg lbs.
18.923 0.7450	19.050 0.7500	-4.1 -0.16	1.5 0.06	35.0 1.38	37.0 1.46	1.5 0.06	64.9 2.56	61.0 2.40	0.5 0.02	1.1 0.05	16.1	10.1	0.0630	0.37 0.83
25.357 0.9983	19.050 0.7500	-8.6 -0.34	2.3 0.09	35.0 1.38	39.0 1.54	1.3 0.05	64.0 2.52	61.0 2.40	0.8 0.03	0.8 0.04	23.6	9.6	0.0656	0.48 1.06
25.357 0.9983	19.050 0.7500	-8.6 -0.34	2.3 0.09	35.0 1.38	39.0 1.54	1.5 0.06	64.0 2.52	61.0 2.40	0.8 0.03	0.8 0.04	23.6	9.6	0.0656	0.48 1.06
18.923 0.7450	15.875 0.6250	-4.1 -0.16	1.5 0.06	35.0 1.38	37.0 1.46	1.5 0.06	65.0 2.56	62.0 2.44	0.5 0.02	1.1 0.05	16.1	10.1	0.0630	0.39 0.87
24.257 0.9550	17.462 0.6875	-4.1 -0.16	4.8 0.19	36.5 1.44	48.0 1.89	1.5 0.06	68.0 2.68	61.0 2.40	3.0 0.12	2.3 0.09	13.0	5.8	0.0686	0.47 1.02
24.257 0.9550	17.462 0.6875	-4.1 -0.16	1.5 0.06	36.5 1.44	41.5 1.63	1.5 0.06	68.0 2.68	61.0 2.40	3.0 0.12	2.3 0.09	13.0	5.8	0.0686	0.47 1.04
29.997 1.1810	23.812 0.9375	-10.2 -0.40	3.5 0.14	37.0 1.46	43.5 1.71	3.3 0.13	67.0 2.64	61.0 2.40	1.5 0.06	0.6 0.02	23.4	8.8	0.0697	0.62 1.35
29.997 1.1810	23.812 0.9375	-10.2 -0.40	1.3 0.05	37.0 1.46	39.0 1.54	3.3 0.13	67.0 2.64	61.0 2.40	1.5 0.06	0.6 0.02	23.4	8.8	0.0697	0.63 1.36
22.225 0.8750	17.462 0.6875	-3.8 -0.15	0.8 0.03	37.0 1.46	37.5 1.48	3.3 0.13	68.0 2.68	62.0 2.44	1.4 0.05	1.0 0.04	20.6	10.1	0.0740	0.47 1.05
22.225 0.8750	17.462 0.6875	-3.8 -0.15	0.8 0.03	37.0 1.46	37.5 1.48	0.8 0.03	68.0 2.68	64.0 2.52	1.4 0.05	1.0 0.04	20.6	10.1	0.0740	0.48 1.07
18.923 0.7450	15.875 0.6250	-4.1 -0.16	1.5 0.06	35.0 1.38	37.0 1.46	1.5 0.06	66.0 2.60	64.0 2.52	0.5 0.02	1.1 0.05	16.1	10.1	0.0630	0.45 1.00
29.997 1.1810	23.812 0.9375	-10.2 -0.40	1.3 0.05	37.0 1.46	39.0 1.54	0.8 0.03	69.0 2.72	65.0 2.56	1.5 0.06	0.6 0.02	23.4	8.8	0.0697	0.71 1.55
24.074 0.9478	17.462 0.6875	-2.0 -0.08	0.8 0.03	41.5 1.63	42.5 1.67	1.5 0.06	74.0 2.91	67.0 2.64	3.4 0.13	2.4 0.10	16.8	7.6	0.0774	0.62 1.35
14.732 0.5800	10.668 0.4200	-3.3 -0.13	3.5 0.14	33.5 1.32	40.0 1.57	1.3 0.05	48.0 1.89	44.5 1.75	0.5 0.02	0.8 0.04	10.8	12.4	0.0559	0.11 0.25
25.433 1.0013	19.050 0.7500	-9.4 -0.37	0.8 0.03	36.5 1.44	37.5 1.48	1.3 0.05	60.0 2.36	58.0 2.28	0.7 0.03	0.8 0.04	19.3	8.0	0.0598	0.40 0.89
25.433 1.0013	19.050 0.7500	-9.4 -0.37	3.5 0.14	35.0 1.38	41.0 1.61	1.3 0.05	60.0 2.36	58.0 2.28	0.7 0.03	0.8 0.04	19.3	8.0	0.0598	0.39 0.88
16.566 0.6522	14.288 0.5625	-3.6 -0.14	1.5 0.06	36.0 1.42	38.5 1.52	1.5 0.06	57.0 2.24	54.0 2.13	0.2 0.01	1.9 0.08	11.8	7.5	0.0579	0.22 0.50

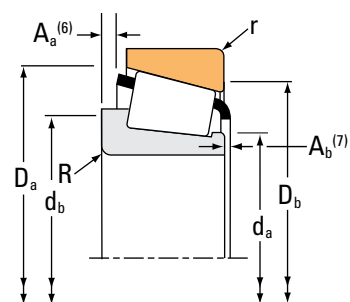
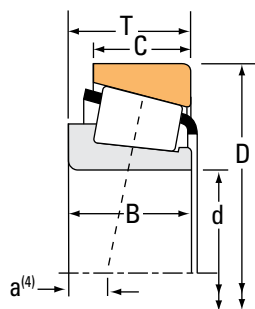
⁽⁴⁾Negative value indicates effective center inside cone (inner-ring) backface.
⁽⁵⁾These maximum fillet radii will be cleared by the bearing corners.
⁽⁶⁾Negative value indicates cage extends beyond cone (inner-ring) backface.
⁽⁷⁾Negative value indicates cage that does not extend beyond cone (inner-ring) front face.

Continued on next page.

TAPERED ROLLER BEARINGS

SINGLE-ROW • TYPE TS

TYPE TS



Bearing Dimensions			Load Ratings					Part Number				
Bore d	O.D. D	Width T	Dynamic ⁽¹⁾		Factors ⁽²⁾		Dynamic ⁽³⁾		Static		Inner	Outer
			C ₁	e	Y	C ₉₀	C _{a90}	K	C ₀			
mm in.	mm in.	mm in.	N lbf			N lbf	N lbf		N lbf			
29.987 1.1806	62.000 2.4409	16.002 0.6300	43200 9720	0.38	1.57	11200 2520	7340 1650	1.53	44100 9910		17118	17244
29.987 1.1806	62.000 2.4409	18.161 0.7150	59900 13500	0.35	1.71	15500 3490	9310 2090	1.67	53900 12100		15115	15245
29.987 1.1806	62.000 2.4409	19.050 0.7500	59900 13500	0.35	1.71	15500 3490	9310 2090	1.67	53900 12100		15117	15245
29.987 1.1806	62.000 2.4409	20.638 0.8125	59900 13500	0.35	1.71	15500 3490	9310 2090	1.67	53900 12100		15117	15244
29.987 1.1806	62.000 2.4409	20.638 0.8125	59900 13500	0.35	1.71	15500 3490	9310 2090	1.67	53900 12100		15117	15244X
29.987 1.1806	63.500 2.5000	20.638 0.8125	59900 13500	0.35	1.71	15500 3490	9310 2090	1.67	53900 12100		15117	15250
29.987 1.1806	68.262 2.6875	21.000 0.8268	63800 14300	0.42	1.44	16500 3720	11800 2650	1.40	70200 15800		02474A	02420A
29.987 1.1806	69.012 2.7170	19.845 0.7813	64700 14500	0.38	1.57	16800 3770	11000 2470	1.53	61700 13900		14118AS	14276
29.987 1.1806	72.000 2.8346	19.000 0.7480	69600 15700	0.36	1.67	18100 4060	11100 2500	1.62	60100 13500		26118	26283
29.987 1.1806	76.200 3.0000	19.000 0.7480	69600 15700	0.36	1.67	18100 4060	11100 2500	1.62	60100 13500		26118	26300
29.987 1.1806	76.200 3.0000	24.608 0.9688	77600 17500	0.67	0.90	20100 4520	23000 5170	0.87	76200 17100		43117	43300
30.000 1.1811	62.000 2.4409	16.002 0.6300	43200 9720	0.38	1.57	11200 2520	7340 1650	1.53	44100 9910		17118-S	17244
30.000 1.1811	68.956 2.7148	19.845 0.7813	54600 12300	0.38	1.57	14200 3180	9260 2080	1.53	61700 13900		14117A	14274A
30.000 1.1811	69.012 2.7170	19.845 0.7813	54600 12300	0.38	1.57	14200 3180	9260 2080	1.53	61700 13900		14118	14276
30.000 1.1811	69.012 2.7170	19.845 0.7813	54600 12300	0.38	1.57	14200 3180	9260 2080	1.53	61700 13900		14117A	14276
30.000 1.1811	69.012 2.7170	19.845 0.7813	54600 12300	0.38	1.57	14200 3180	9260 2080	1.53	61700 13900		14118	14274
30.000 1.1811	69.012 2.7170	19.845 0.7813	54600 12300	0.38	1.57	14200 3180	9260 2080	1.53	61700 13900		14118A	14274

⁽¹⁾Based on 1 x 10⁶ revolutions L₁₀ life, for the ISO life-calculation method.

⁽²⁾Consult your Timken engineer for instructions on use or review the Timken Engineering Manual on timken.com/catalogs.

⁽³⁾Based on 90 x 10⁶ revolutions L₁₀ life, for The Timken Company life-calculation method. C₉₀ and C_{a90} are radial and thrust values.

Bearing Dimensions											Geometry Factors			Bearing Weight
Width B	Width C	Eff. Ctr. a ⁽⁴⁾	Shaft			Housing			Cage		G ₁	G ₂	C _g	
			Max Shaft Fillet Radius R ⁽⁵⁾	Backing Shoulder Dia. d _a	Backing Shoulder Dia. d _b	Max Housing Fillet Radius r ⁽⁵⁾	Backing Shoulder Dia. D _a	Backing Shoulder Dia. D _b	A _a ⁽⁶⁾	A _b ⁽⁷⁾				
mm in.	mm in.	mm in.	mm in.	mm in.	mm in.	mm in.	mm in.	mm in.	mm in.	mm in.				kg lbs.
16.566 0.6522	14.288 0.5625	-3.6 -0.14	1.5 0.06	36.0 1.42	38.5 1.52	1.5 0.06	57.0 2.24	54.0 2.13	0.2 0.01	1.9 0.08	11.8	7.5	0.0579	0.24 0.54
19.050 0.7500	14.288 0.5625	-4.8 -0.19	1.3 0.05	36.5 1.44	38.5 1.52	1.3 0.05	58.0 2.28	55.0 2.17	0.3 0.01	1.8 0.07	14.6	10.0	0.0606	0.26 0.56
20.638 0.8125	14.288 0.5625	-5.8 -0.23	1.3 0.05	35.0 1.38	36.5 1.44	1.3 0.05	58.0 2.28	55.0 2.17	1.1 0.04	1.1 0.05	14.6	10.0	0.0606	0.27 0.58
20.638 0.8125	15.875 0.6250	-5.8 -0.23	1.3 0.05	35.0 1.38	36.5 1.44	1.3 0.05	58.0 2.28	55.0 2.17	1.1 0.04	1.1 0.05	14.6	10.0	0.0606	0.28 0.61
20.638 0.8125	15.875 0.6250	-5.8 -0.23	1.3 0.05	35.0 1.38	36.5 1.44	1.5 0.06	58.0 2.28	55.0 2.17	1.1 0.04	1.1 0.05	14.6	10.0	0.0606	0.28 0.61
20.638 0.8125	15.875 0.6250	-5.8 -0.23	1.3 0.05	35.0 1.38	36.5 1.44	1.3 0.05	59.0 2.32	56.0 2.20	1.1 0.04	1.1 0.05	14.6	10.0	0.0606	0.30 0.65
22.225 0.8750	16.238 0.6393	-5.1 -0.20	0.8 0.03	38.5 1.52	39.5 1.56	1.5 0.06	63.0 2.48	59.0 2.32	1.1 0.04	0.9 0.04	17.5	8.5	0.0681	0.39 0.84
19.202 0.7560	15.875 0.6250	-4.3 -0.17	0.8 0.03	37.0 1.46	37.5 1.48	1.3 0.05	63.0 2.48	60.0 2.36	1.0 0.04	1.9 0.08	18.0	13.3	0.0668	0.36 0.80
18.923 0.7450	15.875 0.6250	-4.1 -0.16	1.5 0.06	36.0 1.42	38.0 1.50	1.5 0.06	65.0 2.56	62.0 2.44	0.5 0.02	1.1 0.05	16.1	10.1	0.0630	0.38 0.85
18.923 0.7450	15.875 0.6250	-4.1 -0.16	1.5 0.06	36.0 1.42	38.0 1.50	1.5 0.06	66.0 2.60	64.0 2.52	0.5 0.02	1.1 0.05	16.1	10.1	0.0630	0.44 0.98
24.074 0.9478	16.670 0.6563	-2.0 -0.08	1.5 0.06	42.1 1.66	44.5 1.75	3.3 0.13	73.0 2.87	64.0 2.52	3.4 0.13	2.4 0.10	16.8	7.6	0.0774	0.53 1.16
16.566 0.6522	14.288 0.5625	-3.6 -0.14	1.5 0.06	34.5 1.36	37.0 1.46	1.5 0.06	57.0 2.24	54.0 2.13	0.2 0.01	1.9 0.08	11.8	7.5	0.0579	0.24 0.54
19.583 0.7710	15.875 0.6250	-4.3 -0.17	3.5 0.14	41.0 1.61	44.0 1.73	3.3 0.13	63.0 2.48	59.0 2.32	1.0 0.04	1.5 0.06	18.0	13.3	0.0668	0.34 0.78
19.202 0.7560	15.875 0.6250	-4.3 -0.17	0.8 0.03	36.5 1.44	37.0 1.46	1.3 0.05	63.0 2.48	60.0 2.36	1.0 0.04	1.9 0.08	18.0	13.3	0.0668	0.35 0.79
19.583 0.7710	15.875 0.6250	-4.3 -0.17	3.5 0.14	41.0 1.61	44.0 1.73	1.3 0.05	63.0 2.48	60.0 2.36	1.0 0.04	1.5 0.06	18.0	13.3	0.0668	0.35 0.79
19.202 0.7560	15.875 0.6250	-4.3 -0.17	0.8 0.03	36.5 1.44	37.0 1.46	3.3 0.13	63.0 2.48	59.0 2.32	1.0 0.04	1.9 0.08	18.0	13.3	0.0668	0.35 0.78
19.583 0.7710	15.875 0.6250	-4.3 -0.17	3.5 0.14	37.0 1.46	43.0 1.69	3.3 0.13	63.0 2.48	59.0 2.32	1.0 0.04	1.5 0.06	18.0	13.3	0.0668	0.36 0.78

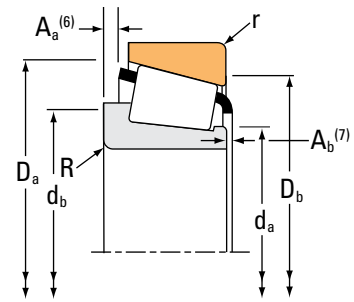
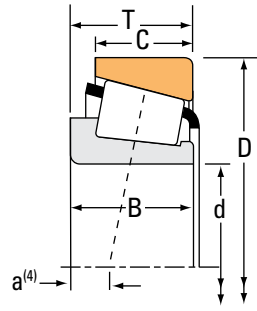
(4) Negative value indicates effective center inside cone (inner-ring) backface.
 (5) These maximum fillet radii will be cleared by the bearing corners.
 (6) Negative value indicates cage extends beyond cone (inner-ring) backface.
 (7) Negative value indicates cage that does not extend beyond cone (inner-ring) front face.

Continued on next page.

TAPERED ROLLER BEARINGS

SINGLE-ROW • TYPE TS

TYPE TS



Bearing Dimensions			Load Ratings						Part Number				
Bore d	O.D. D	Width T	Dynamic ⁽¹⁾		Factors ⁽²⁾		Dynamic ⁽³⁾		Factors ⁽²⁾		Static C ₀	Inner	Outer
			C ₁	e	Y	C ₉₀	C _{a90}	K	N	N			
mm in.	mm in.	mm in.	N lbf			N lbf	N lbf		N lbf				
30.000 1.1811	69.850 2.7500	23.812 0.9375	83700 18800	0.27	2.19	21700 4880	10200 2280	2.14	94400 21200		2586	2523	
30.000 1.1811	69.850 2.7500	23.812 0.9375	83700 18800	0.27	2.19	21700 4880	10200 2280	2.14	94400 21200		2560X	2523-S	
30.000 1.1811	69.850 2.7500	23.812 0.9375	83700 18800	0.27	2.19	21700 4880	10200 2280	2.14	94400 21200		2560X	2523	
30.000 1.1811	72.000 2.8346	19.000 0.7480	69600 15700	0.36	1.67	18100 4060	11100 2500	1.62	60100 13500		26118-S	26283-S	
30.000 1.1811	72.000 2.8346	23.812 0.9375	83700 18800	0.27	2.19	21700 4880	10200 2280	2.14	94400 21200		2560X	2526X	
30.000 1.1811	72.000 2.8346	29.370 1.1563	103000 23200	0.55	1.10	26700 6010	25000 5620	1.07	111000 24900		JHM88540	JHM88513	
30.000 1.1811	72.022 2.8355	23.812 0.9375	83700 18800	0.27	2.19	21700 4880	10200 2280	2.14	94400 21200		2586	2525	
30.000 1.1811	72.034 2.8360	30.162 1.1875	94800 21300	0.33	1.80	24600 5520	14000 3140	1.76	102000 22800		3190	3126	
30.000 1.1811	72.085 2.8380	22.385 0.8813	54600 12300	0.38	1.57	14200 3180	9260 2080	1.53	61700 13900		14117A	14283	
30.000 1.1811	72.085 2.8380	22.385 0.8813	54600 12300	0.38	1.57	14200 3180	9260 2080	1.53	61700 13900		14118	14283	
30.112 1.1855	62.000 2.4409	19.050 0.7500	59900 13500	0.35	1.71	15500 3490	9310 2090	1.67	53900 12100		15116	15245	
30.112 1.1855	63.500 2.5000	20.638 0.8125	59900 13500	0.35	1.71	15500 3490	9310 2090	1.67	53900 12100		15116	15250	
30.162 1.1875	58.738 2.3125	14.684 0.5781	31700 7130	0.47	1.27	8220 1850	6670 1500	1.23	35000 7880		08118	08231	
30.162 1.1875	58.788 2.3145	14.684 0.5781	31700 7130	0.47	1.27	8220 1850	6670 1500	1.23	35000 7880		08118	08237	
30.162 1.1875	62.000 2.4409	16.002 0.6300	43200 9720	0.38	1.57	11200 2520	7340 1650	1.53	44100 9910		17119	17244	
30.162 1.1875	64.292 2.5312	21.433 0.8438	60200 13500	0.55	1.10	15600 3510	14600 3280	1.07	71700 16100		M86649	M86610	
30.162 1.1875	66.421 2.6150	19.050 0.7500	55900 12600	0.34	1.77	14500 3260	8420 1890	1.72	55200 12400		24118	24261	

⁽¹⁾Based on 1×10^6 revolutions L_{10} life, for the ISO life-calculation method.

⁽²⁾Consult your Timken engineer for instructions on use or review the Timken Engineering Manual on timken.com/catalogs.

⁽³⁾Based on 90×10^6 revolutions L_{10} life, for The Timken Company life-calculation method. C_{90} and C_{a90} are radial and thrust values.

Bearing Dimensions											Geometry Factors			Bearing Weight
Width B	Width C	Eff. Ctr. a ⁽⁴⁾	Shaft			Housing			Cage		G ₁	G ₂	C _g	
			Max Shaft Fillet Radius R ⁽⁵⁾	Backing Shoulder Dia. d _a	Shoulder Dia. d _b	Max Housing Fillet Radius r ⁽⁵⁾	Backing Shoulder Dia. D _a	Shoulder Dia. D _b	A _a ⁽⁶⁾	A _b ⁽⁷⁾				
mm in.	mm in.	mm in.	mm in.	mm in.	mm in.	mm in.	mm in.	mm in.	mm in.	mm in.				kg lbs.
25.357 0.9983	19.050 0.7500	-8.6 -0.34	3.5 0.14	36.0 1.42	42.5 1.67	1.3 0.05	64.0 2.52	61.0 2.40	0.8 0.03	0.8 0.04	23.6	9.6	0.0656	0.47 1.02
25.357 0.9983	19.050 0.7500	-8.6 -0.34	2.0 0.08	36.0 1.42	39.5 1.56	1.5 0.06	64.0 2.52	61.0 2.40	0.8 0.03	0.8 0.04	23.6	9.6	0.0656	0.47 1.03
25.357 0.9983	19.050 0.7500	-8.6 -0.34	2.0 0.08	36.0 1.42	39.5 1.56	1.3 0.05	64.0 2.52	61.0 2.40	0.8 0.03	0.8 0.04	23.6	9.6	0.0656	0.47 1.03
18.923 0.7450	15.875 0.6250	-4.1 -0.16	1.5 0.06	36.0 1.42	38.0 1.50	2.0 0.08	65.0 2.56	62.0 2.44	0.5 0.02	1.1 0.05	16.1	10.1	0.0630	0.38 0.84
25.357 0.9983	19.050 0.7500	-8.6 -0.34	2.0 0.08	36.0 1.42	39.5 1.56	2.0 0.08	65.0 2.56	61.0 2.40	0.8 0.03	0.8 0.04	23.6	9.6	0.0656	0.50 1.11
27.783 1.0938	23.020 0.9063	-5.6 -0.22	1.3 0.05	42.5 1.67	44.5 1.75	3.3 0.13	69.0 2.72	58.0 2.28	1.9 0.07	1.8 0.08	26.3	8.7	0.0857	0.60 1.34
25.357 0.9983	19.050 0.7500	-8.6 -0.34	3.5 0.14	36.0 1.42	42.5 1.67	0.8 0.03	65.0 2.56	63.0 2.48	0.8 0.03	0.8 0.04	23.6	9.6	0.0656	0.50 1.10
29.997 1.1810	23.812 0.9375	-10.2 -0.40	3.5 0.14	38.0 1.50	44.5 1.75	2.8 0.11	67.0 2.64	61.0 2.40	* *	* *	23.4	8.8	0.0697	0.60 1.30
19.583 0.7710	18.415 0.7250	-4.3 -0.17	3.5 0.14	41.0 1.61	44.0 1.73	2.3 0.09	65.0 2.56	60.0 2.36	1.0 0.04	1.5 0.06	18.0	13.3	0.0668	0.43 0.96
19.202 0.7560	18.415 0.7250	-4.3 -0.17	0.8 0.03	36.5 1.44	37.0 1.46	2.3 0.09	65.0 2.56	60.0 2.36	1.0 0.04	1.9 0.08	18.0	13.3	0.0668	0.43 0.96
20.638 0.8125	14.288 0.5625	-5.8 -0.23	0.8 0.03	35.5 1.40	36.0 1.42	1.3 0.05	58.0 2.28	55.0 2.17	1.2 0.04	1.1 0.05	14.6	10.0	0.0606	0.26 0.58
20.638 0.8125	15.875 0.6250	-5.8 -0.23	0.8 0.03	35.5 1.40	36.0 1.42	1.3 0.05	59.0 2.32	56.0 2.20	1.2 0.04	1.1 0.05	14.6	10.0	0.0606	0.29 0.65
15.080 0.5937	10.716 0.4219	-1.3 -0.05	3.5 0.14	35.0 1.38	41.5 1.63	1.0 0.04	55.0 2.17	52.0 2.05	0.8 0.03	1.1 0.05	10.7	10.6	0.0601	0.18 0.38
15.080 0.5937	10.716 0.4219	-1.3 -0.05	3.5 0.14	35.0 1.38	41.5 1.63	1.0 0.04	55.0 2.17	52.0 2.05	0.8 0.03	1.1 0.05	10.7	10.6	0.0601	0.18 0.38
16.566 0.6522	14.288 0.5625	-3.6 -0.14	1.5 0.06	34.5 1.36	37.0 1.46	1.5 0.06	57.0 2.24	54.0 2.13	0.2 0.01	1.9 0.08	11.8	7.5	0.0579	0.24 0.53
21.433 0.8438	16.670 0.6563	-3.3 -0.13	1.5 0.06	38.0 1.50	44.0 1.73	1.5 0.06	60.0 2.36	54.0 2.13	1.3 0.05	1.3 0.05	16.8	7.4	0.0736	0.34 0.74
18.974 0.7470	15.875 0.6250	-4.8 -0.19	1.5 0.06	35.0 1.38	37.5 1.48	1.5 0.06	61.0 2.40	58.0 2.28	0.3 0.01	1.5 0.06	14.0	8.3	0.0589	0.30 0.67

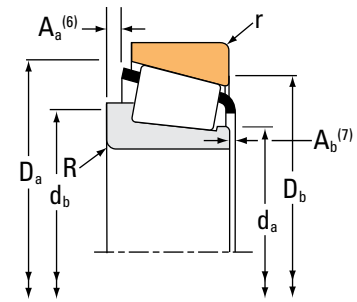
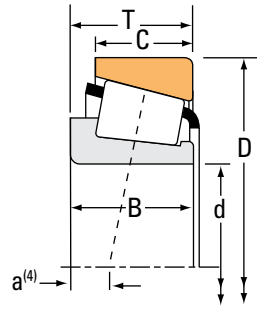
(4) Negative value indicates effective center inside cone (inner-ring) backface.
 (5) These maximum fillet radii will be cleared by the bearing corners.
 (6) Negative value indicates cage extends beyond cone (inner-ring) backface.
 (7) Negative value indicates cage that does not extend beyond cone (inner-ring) front face.
 (*) Contact your Timken engineer for details.

Continued on next page.

TAPERED ROLLER BEARINGS

SINGLE-ROW • TYPE TS

TYPE TS



Bearing Dimensions			Load Ratings						Part Number				
Bore d	O.D. D	Width T	Dynamic ⁽¹⁾		Factors ⁽²⁾		Dynamic ⁽³⁾		Factors ⁽²⁾		Static C ₀	Inner	Outer
			C ₁	e	Y	C ₉₀	C _{a90}	K	N	N			
mm in.	mm in.	mm in.	N lbf			N lbf	N lbf		N lbf				
30.162 1.1875	66.421 2.6150	25.400 1.0000	83700 18800	0.27	2.19	21700 4880	10200 2280	2.14	94400 21200		2558	2530	
30.162 1.1875	69.850 2.7500	23.812 0.9375	83700 18800	0.27	2.19	21700 4880	10200 2280	2.14	94400 21200		2558	2523	
30.162 1.1875	69.850 2.7500	23.812 0.9375	83700 18800	0.27	2.19	21700 4880	10200 2280	2.14	94400 21200		2558	2523-S	
30.162 1.1875	72.625 2.8593	30.162 1.1875	94800 21300	0.33	1.80	24600 5520	14000 3140	1.76	102000 22800		3191	3120	
30.162 1.1875	72.625 2.8593	30.162 1.1875	94800 21300	0.33	1.80	24600 5520	14000 3140	1.76	102000 22800		3187	3120	
30.162 1.1875	76.200 3.0000	20.638 0.8125	75200 16900	0.40	1.49	19500 4390	13400 3020	1.45	68900 15500		28118	28300	
30.162 1.1875	76.200 3.0000	24.608 0.9688	92000 20700	0.67	0.90	23900 5360	27300 6130	0.87	76200 17100		43118	43300	
30.162 1.1875	79.375 3.1250	25.400 1.0000	92000 20700	0.67	0.90	23900 5360	27300 6130	0.87	76200 17100		43118	43312	
30.162 1.1875	80.000 3.1496	21.006 0.8270	75200 16900	0.40	1.49	19500 4390	13400 3020	1.45	68900 15500		28118	28315	
30.175 1.1880	62.000 2.4409	19.050 0.7500	59900 13500	0.35	1.71	15500 3490	9310 2090	1.67	53900 12100		15120A	15245	
30.213 1.1895	62.000 2.4409	20.638 0.8125	59900 13500	0.35	1.71	15500 3490	9310 2090	1.67	53900 12100		15118	15244	
30.213 1.1895	62.000 2.4409	20.638 0.8125	59900 13500	0.35	1.71	15500 3490	9310 2090	1.67	53900 12100		15120	15244	
30.213 1.1895	63.500 2.5000	20.638 0.8125	59900 13500	0.35	1.71	15500 3490	9310 2090	1.67	53900 12100		15118	15250X	
30.213 1.1895	63.500 2.5000	20.638 0.8125	59900 13500	0.35	1.71	15500 3490	9310 2090	1.67	53900 12100		15119	15250	
30.213 1.1895	63.500 2.5000	20.638 0.8125	59900 13500	0.35	1.71	15500 3490	9310 2090	1.67	53900 12100		15120	15250	
30.213 1.1895	63.500 2.5000	20.638 0.8125	59900 13500	0.35	1.71	15500 3490	9310 2090	1.67	53900 12100		15118	15250	
30.213 1.1895	63.500 2.5000	20.638 0.8125	59900 13500	0.35	1.71	15500 3490	9310 2090	1.67	53900 12100		15119	15249	

⁽¹⁾Based on 1×10^6 revolutions L_{10} life, for the ISO life-calculation method.

⁽²⁾Consult your Timken engineer for instructions on use or review the Timken Engineering Manual on timken.com/catalogs.

⁽³⁾Based on 90×10^6 revolutions L_{10} life, for The Timken Company life-calculation method. C_{90} and C_{a90} are radial and thrust values.

Bearing Dimensions											Geometry Factors			Bearing Weight
Width B	Width C	Eff. Ctr. a ⁽⁴⁾	Shaft			Housing			Cage		G ₁	G ₂	C _g	
			Max Shaft Fillet Radius R ⁽⁵⁾	Backing Shoulder Dia. d _a	Shoulder Dia. d _b	Max Housing Fillet Radius r ⁽⁵⁾	Backing Shoulder Dia. D _a	Shoulder Dia. D _b	A _a ⁽⁶⁾	A _b ⁽⁷⁾				
mm in.	mm in.	mm in.	mm in.	mm in.	mm in.	mm in.	mm in.	mm in.	mm in.	mm in.				kg lbs.
25.357 0.9983	20.638 0.8125	-8.6 -0.34	2.3 0.09	36.5 1.44	40.0 1.57	0.8 0.03	62.5 2.46	59.9 2.36	0.8 0.03	0.8 0.04	23.6	9.6	0.0656	0.43 0.94
25.357 0.9983	19.050 0.7500	-8.6 -0.34	2.3 0.09	36.5 1.44	40.0 1.57	1.3 0.05	64.0 2.52	61.0 2.40	0.8 0.03	0.8 0.04	23.6	9.6	0.0656	0.47 1.03
25.357 0.9983	19.050 0.7500	-8.6 -0.34	2.3 0.09	36.5 1.44	40.0 1.57	1.5 0.06	64.0 2.52	61.0 2.40	0.8 0.03	0.8 0.04	23.6	9.6	0.0656	0.47 1.03
29.997 1.1810	23.812 0.9375	-10.2 -0.40	3.5 0.14	38.5 1.52	44.5 1.75	3.3 0.13	67.0 2.64	61.0 2.40	* *	* *	23.4	8.8	0.0697	0.60 1.32
29.997 1.1810	23.812 0.9375	-10.2 -0.40	0.8 0.03	38.5 1.52	39.0 1.54	3.3 0.13	67.0 2.64	61.0 2.40	* *	* *	23.4	8.8	0.0697	0.61 1.33
20.940 0.8244	15.507 0.6105	-4.8 -0.19	1.5 0.06	37.5 1.48	40.0 1.57	1.3 0.05	71.0 2.80	68.0 2.68	2.3 0.09	1.1 0.05	20.7	12.5	0.0709	0.47 1.04
24.074 0.9478	16.670 0.6563	-2.0 -0.08	1.5 0.06	42.1 1.65	45.0 1.77	3.3 0.13	73.0 2.87	64.0 2.52	3.4 0.13	2.4 0.10	16.8	7.6	0.0774	0.53 1.16
24.074 0.9478	17.462 0.6875	-2.0 -0.08	1.5 0.06	42.1 1.65	45.0 1.77	1.5 0.06	74.0 2.91	67.0 2.64	3.4 0.13	2.4 0.10	16.8	7.6	0.0774	0.60 1.31
20.940 0.8244	15.875 0.6250	-4.8 -0.19	1.5 0.06	37.5 1.48	40.0 1.57	1.5 0.06	73.0 2.87	69.0 2.72	2.3 0.09	1.1 0.05	20.7	12.5	0.0709	0.53 1.17
20.638 0.8125	14.288 0.5625	-5.8 -0.23	0.5 0.02	35.5 1.40	35.5 1.40	1.3 0.05	58.0 2.28	55.0 2.17	1.1 0.04	1.1 0.05	14.6	10.0	0.0606	0.26 0.58
20.638 0.8125	15.875 0.6250	-5.8 -0.23	3.5 0.14	36.5 1.44	43.0 1.69	1.3 0.05	58.0 2.28	55.0 2.17	1.1 0.04	1.1 0.05	14.6	10.0	0.0606	0.27 0.60
20.638 0.8125	15.875 0.6250	-5.8 -0.23	0.8 0.03	35.5 1.40	36.0 1.42	1.3 0.05	58.0 2.28	55.0 2.17	1.2 0.04	1.1 0.05	14.6	10.0	0.0606	0.27 0.61
20.638 0.8125	15.875 0.6250	-5.8 -0.23	3.5 0.14	36.5 1.44	43.0 1.69	1.5 0.06	59.0 2.32	55.0 2.17	1.1 0.04	1.1 0.05	14.6	10.0	0.0606	0.29 0.64
20.638 0.8125	15.875 0.6250	-5.8 -0.23	1.5 0.06	35.5 1.40	37.5 1.48	1.3 0.05	59.0 2.32	56.0 2.20	* *	* *	14.6	10.0	0.0606	0.29 0.65
20.638 0.8125	15.875 0.6250	-5.8 -0.23	0.8 0.03	35.5 1.40	36.0 1.42	1.3 0.05	59.0 2.32	56.0 2.20	1.2 0.04	1.1 0.05	14.6	10.0	0.0606	0.29 0.65
20.638 0.8125	15.875 0.6250	-5.8 -0.23	3.5 0.14	36.5 1.44	43.0 1.69	1.3 0.05	59.0 2.32	56.0 2.20	1.1 0.04	1.1 0.05	14.6	10.0	0.0606	0.29 0.64
20.638 0.8125	15.875 0.6250	-5.8 -0.23	1.5 0.06	35.5 1.40	37.5 1.48	1.5 0.06	59.0 2.32	55.0 2.17	* *	* *	14.6	10.0	0.0606	0.29 0.64

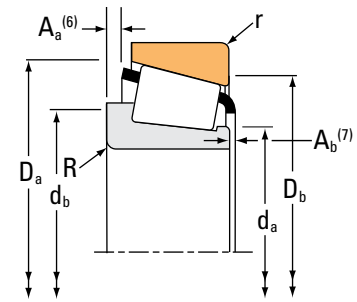
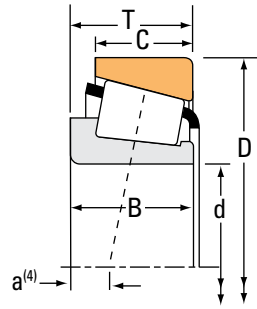
(4) Negative value indicates effective center inside cone (inner-ring) backface.
 (5) These maximum fillet radii will be cleared by the bearing corners.
 (6) Negative value indicates cage extends beyond cone (inner-ring) backface.
 (7) Negative value indicates cage that does not extend beyond cone (inner-ring) front face.
 (*) Contact your Timken engineer for details.

Continued on next page.

TAPERED ROLLER BEARINGS

SINGLE-ROW • TYPE TS

TYPE TS



Bearing Dimensions			Load Ratings						Part Number				
Bore d	O.D. D	Width T	Dynamic ⁽¹⁾		Factors ⁽²⁾		Dynamic ⁽³⁾		Factors ⁽²⁾		Static C ₀	Inner	Outer
			C ₁	e	Y	C ₉₀	C _{a90}	K	N	N			
mm in.	mm in.	mm in.	N lbf			N lbf	N lbf		N lbf				
30.213 1.1895	66.421 2.6150	25.400 1.0000	83700 18800	0.27	2.19	21700 4880	10200 2280	2.14	94400 21200		2561X	2520	
30.213 1.1895	69.850 2.7500	23.812 0.9375	83700 18800	0.27	2.19	21700 4880	10200 2280	2.14	94400 21200		2561X	2523	
30.213 1.1895	69.850 2.7500	23.812 0.9375	83700 18800	0.27	2.19	21700 4880	10200 2280	2.14	94400 21200		2561X	2523-S	
30.226 1.1900	69.012 2.7170	19.845 0.7813	54600 12300	0.38	1.57	14200 3180	9260 2080	1.53	61700 13900		14116	14276	
30.955 1.2187	64.292 2.5312	21.432 0.8438	60200 13500	0.55	1.10	15600 3510	14600 3280	1.07	71700 16100		M86648A	M86610	
31.623 1.2450	66.675 2.6250	20.638 0.8125	52500 11800	0.37	1.62	13600 3060	8650 1950	1.57	57900 13000		1674	1620	
31.750 1.2500	58.738 2.3125	14.684 0.5781	31700 7130	0.47	1.27	8220 1850	6670 1500	1.23	35000 7880		08125	08231	
31.750 1.2500	59.131 2.3280	15.875 0.6250	46700 10500	0.41	1.46	12100 2720	8550 1920	1.42	44600 10000		LM67048	LM67010	
31.750 1.2500	59.131 2.3280	15.875 0.6250	46700 10500	0.41	1.46	12100 2720	8550 1920	1.42	44600 10000		LM67047	LM67010	
31.750 1.2500	59.131 2.3280	15.875 0.6250	46700 10500	0.41	1.46	12100 2720	8550 1920	1.42	44600 10000		LM67049A	LM67010	
31.750 1.2500	59.131 2.3280	15.875 0.6250	46700 10500	0.41	1.46	12100 2720	8550 1920	1.42	44600 10000		LM67045	LM67010	
31.750 1.2500	61.986 2.4404	15.875 0.6250	46700 10500	0.41	1.46	12100 2720	8550 1920	1.42	44600 10000		LM67048	LM67014	
31.750 1.2500	61.986 2.4404	15.875 0.6250	46700 10500	0.41	1.46	12100 2720	8550 1920	1.42	44600 10000		LM67049A	LM67014	
31.750 1.2500	61.986 2.4404	15.875 0.6250	46700 10500	0.41	1.46	12100 2720	8550 1920	1.42	44600 10000		LM67045	LM67014	
31.750 1.2500	62.000 2.4409	18.161 0.7150	59900 13500	0.35	1.71	15500 3490	9310 2090	1.67	53900 12100		15123	15245	
31.750 1.2500	62.000 2.4409	19.050 0.7500	59900 13500	0.35	1.71	15500 3490	9310 2090	1.67	53900 12100		15126	15245	
31.750 1.2500	62.000 2.4409	19.050 0.7500	59900 13500	0.35	1.71	15500 3490	9310 2090	1.67	53900 12100		15125	15245	

⁽¹⁾Based on 1 x 10⁶ revolutions L₁₀ life, for the ISO life-calculation method.

⁽²⁾Consult your Timken engineer for instructions on use or review the Timken Engineering Manual on timken.com/catalogs.

⁽³⁾Based on 90 x 10⁶ revolutions L₁₀ life, for The Timken Company life-calculation method. C₉₀ and C_{a90} are radial and thrust values.

Bearing Dimensions											Geometry Factors			Bearing Weight
Width B	Width C	Eff. Ctr. a ⁽⁴⁾	Shaft			Housing			Cage		G ₁	G ₂	C _g	
			Max Shaft Fillet Radius R ⁽⁵⁾	Backing Shoulder Dia. d _a	Backing Shoulder Dia. d _b	Max Housing Fillet Radius r ⁽⁵⁾	Backing Shoulder Dia. D _a	Backing Shoulder Dia. D _b	A _a ⁽⁶⁾	A _b ⁽⁷⁾				
mm in.	mm in.	mm in.	mm in.	mm in.	mm in.	mm in.	mm in.	mm in.	mm in.	mm in.				kg lbs.
24.714 0.9730	20.638 0.8125	-8.6 -0.34	2.3 0.09	36.5 1.44	40.0 1.57	3.3 0.13	62.5 2.46	56.9 2.24	0.8 0.03	1.5 0.06	23.6	9.6	0.0656	0.41 0.91
24.714 0.9730	19.050 0.7500	-8.6 -0.34	2.3 0.09	36.5 1.44	40.0 1.57	1.3 0.05	64.0 2.52	61.0 2.40	0.8 0.03	1.5 0.06	23.6	9.6	0.0656	0.46 1.02
24.714 0.9730	19.050 0.7500	-8.6 -0.34	2.3 0.09	36.5 1.44	40.0 1.57	1.5 0.06	64.0 2.52	61.0 2.40	0.8 0.03	1.5 0.06	23.6	9.6	0.0656	0.46 1.02
19.583 0.7710	15.875 0.6250	-4.3 -0.17	0.8 0.03	38.0 1.50	38.5 1.52	1.3 0.05	63.0 2.48	60.0 2.36	1.0 0.04	1.5 0.06	18.0	13.3	0.0668	0.36 0.80
21.433 0.8438	16.670 0.6563	-3.3 -0.13	1.5 0.06	38.0 1.50	42.0 1.65	1.5 0.06	60.0 2.36	54.0 2.13	1.3 0.05	1.3 0.05	16.8	7.4	0.0736	0.33 0.73
20.638 0.8125	15.875 0.6250	-5.3 -0.21	1.5 0.06	37.0 1.46	39.5 1.56	1.5 0.06	61.0 2.40	58.0 2.28	1.5 0.06	1.1 0.05	16.6	8.7	0.0644	0.33 0.72
15.080 0.5937	10.716 0.4219	-1.3 -0.05	1.0 0.04	36.0 1.42	37.5 1.48	1.0 0.04	55.0 2.17	52.0 2.05	0.8 0.03	1.1 0.05	10.7	10.6	0.0601	0.17 0.37
16.764 0.6600	11.811 0.4650	-3.0 -0.12	3.5 0.14	36.0 1.42	42.5 1.67	1.3 0.05	56.0 2.20	52.0 2.05	0.7 0.02	0.8 0.03	12.8	9.7	0.0612	0.18 0.39
16.764 0.6600	11.811 0.4650	-3.0 -0.12	2.3 0.09	36.0 1.42	40.0 1.57	1.3 0.05	56.0 2.20	52.0 2.05	0.7 0.02	0.8 0.03	12.8	9.7	0.0612	0.18 0.41
16.764 0.6600	11.811 0.4650	-3.0 -0.12	0.8 0.03	36.0 1.42	37.0 1.46	1.3 0.05	56.0 2.20	52.0 2.05	0.7 0.02	0.8 0.03	12.8	9.7	0.0612	0.18 0.41
18.500 0.7283	11.811 0.4650	-3.0 -0.12	2.0 0.08	36.0 1.42	39.5 1.56	1.3 0.05	56.0 2.20	52.0 2.05	0.7 0.03	-1.0 -0.04	12.8	9.7	0.0612	0.19 0.42
16.764 0.6600	11.811 0.4650	-3.0 -0.12	3.5 0.14	36.0 1.42	42.5 1.67	1.3 0.05	57.0 2.24	54.0 2.13	0.7 0.02	0.8 0.03	12.8	9.7	0.0612	0.21 0.44
16.764 0.6600	11.811 0.4650	-3.0 -0.12	0.8 0.03	36.0 1.42	37.0 1.46	1.3 0.05	57.0 2.24	54.0 2.13	0.7 0.02	0.8 0.03	12.8	9.7	0.0612	0.21 0.46
18.500 0.7283	11.811 0.4650	-3.0 -0.12	2.0 0.08	36.0 1.42	39.5 1.56	1.3 0.05	57.0 2.24	54.0 2.13	0.7 0.03	-1.0 -0.04	12.8	9.7	0.0612	0.22 0.47
19.050 0.7500	14.288 0.5625	-4.8 -0.19	3.5 0.14	38.0 1.50	44.0 1.73	1.3 0.05	58.0 2.28	55.0 2.17	0.3 0.01	1.8 0.07	14.6	10.0	0.0606	0.23 0.51
20.638 0.8125	14.288 0.5625	-5.8 -0.23	0.8 0.03	38.0 1.50	38.5 1.52	1.3 0.05	58.0 2.28	55.0 2.17	1.1 0.04	1.1 0.05	14.6	10.0	0.0606	0.25 0.55
20.638 0.8125	14.288 0.5625	-5.8 -0.23	3.5 0.14	36.5 1.44	42.5 1.67	1.3 0.05	58.0 2.28	55.0 2.17	1.2 0.04	1.1 0.05	14.6	10.0	0.0606	0.25 0.54

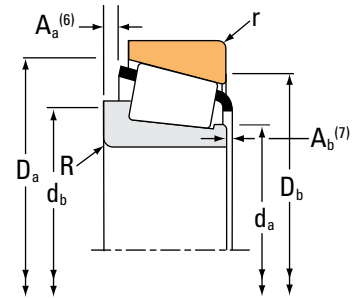
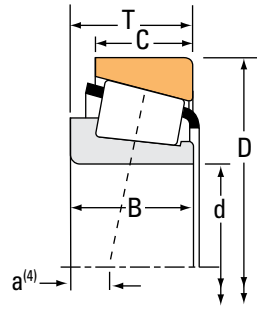
⁽⁴⁾Negative value indicates effective center inside cone (inner-ring) backface.
⁽⁵⁾These maximum fillet radii will be cleared by the bearing corners.
⁽⁶⁾Negative value indicates cage extends beyond cone (inner-ring) backface.
⁽⁷⁾Negative value indicates cage that does not extend beyond cone (inner-ring) front face.

Continued on next page.

TAPERED ROLLER BEARINGS

SINGLE-ROW • TYPE TS

TYPE TS



Bearing Dimensions			Load Ratings					Part Number					
Bore d	O.D. D	Width T	Dynamic ⁽¹⁾		Factors ⁽²⁾		Dynamic ⁽³⁾		Factors ⁽²⁾		Static C ₀	Inner	Outer
			C ₁	e	Y	C ₉₀	C _{a90}	K	N	N			
mm in.	mm in.	mm in.	N lbf			N lbf	N lbf		N lbf				
31.750 1.2500	62.000 2.4409	20.638 0.8125	59900 13500	0.35	1.71	15500 3490	9310 2090	1.67	53900 12100		15125	15244	
31.750 1.2500	62.000 2.4409	20.638 0.8125	59900 13500	0.35	1.71	15500 3490	9310 2090	1.67	53900 12100		15126	15244	
31.750 1.2500	63.500 2.5000	19.748 0.7775	59900 13500	0.35	1.71	15500 3490	9310 2090	1.67	53900 12100		15123	15250	
31.750 1.2500	63.500 2.5000	20.638 0.8125	59900 13500	0.35	1.71	15500 3490	9310 2090	1.67	53900 12100		15125	15250	
31.750 1.2500	63.500 2.5000	20.638 0.8125	59900 13500	0.35	1.71	15500 3490	9310 2090	1.67	53900 12100		15126	15250	
31.750 1.2500	63.500 2.5000	20.638 0.8125	59900 13500	0.35	1.71	15500 3490	9310 2090	1.67	53900 12100		15126	15250X	
31.750 1.2500	66.421 2.6150	25.400 1.0000	83700 18800	0.27	2.19	21700 4880	10200 2280	2.14	94400 21200		2580	2520	
31.750 1.2500	66.421 2.6150	25.400 1.0000	83700 18800	0.27	2.19	21700 4880	10200 2280	2.14	94400 21200		2580	2530	
31.750 1.2500	66.421 2.6150	25.400 1.0000	83700 18800	0.27	2.19	21700 4880	10200 2280	2.14	94400 21200		2580	2520A	
31.750 1.2500	66.421 2.6150	25.400 1.0000	83700 18800	0.27	2.19	21700 4880	10200 2280	2.14	94400 21200		2580A	2520A	
31.750 1.2500	68.262 2.6875	21.000 0.8268	63800 14300	0.42	1.44	16500 3720	11800 2650	1.40	70200 15800		02476	02420A	
31.750 1.2500	68.262 2.6875	22.225 0.8750	67600 15200	0.34	1.77	17500 3940	10200 2290	1.72	73300 16500		2475	2420	
31.750 1.2500	68.262 2.6875	22.225 0.8750	63800 14300	0.42	1.44	16500 3720	11800 2650	1.40	70200 15800		02475	02420	
31.750 1.2500	68.262 2.6875	22.225 0.8750	66700 15000	0.28	2.18	17300 3890	8150 1830	2.12	77900 17500		16579	16522	
31.750 1.2500	68.262 2.6875	22.225 0.8750	63800 14300	0.42	1.44	16500 3720	11800 2650	1.40	70200 15800		02476	02420	
31.750 1.2500	68.262 2.6875	22.225 0.8750	76300 17100	0.55	1.10	19800 4450	18500 4160	1.07	77400 17400		M88046	M88010	
31.750 1.2500	68.262 2.6875	26.988 1.0625	80700 18100	0.35	1.71	20900 4700	12600 2830	1.66	91000 20500		23491	23420	

⁽¹⁾Based on 1 x 10⁶ revolutions L₁₀ life, for the ISO life-calculation method.

⁽²⁾Consult your Timken engineer for instructions on use or review the Timken Engineering Manual on timken.com/catalogs.

⁽³⁾Based on 90 x 10⁶ revolutions L₁₀ life, for The Timken Company life-calculation method. C₉₀ and C_{a90} are radial and thrust values.

Bearing Dimensions											Geometry Factors			Bearing Weight
Width B	Width C	Eff. Ctr. a ⁽⁴⁾	Shaft			Housing			Cage		G ₁	G ₂	C _g	
			Max Shaft Fillet Radius R ⁽⁵⁾	Backing Shoulder Dia. d _a	Backing Shoulder Dia. d _b	Max Housing Fillet Radius r ⁽⁵⁾	Backing Shoulder Dia. D _a	Backing Shoulder Dia. D _b	A _a ⁽⁶⁾	A _b ⁽⁷⁾				
mm in.	mm in.	mm in.	mm in.	mm in.	mm in.	mm in.	mm in.	mm in.	mm in.	mm in.				kg lbs.
20.638 0.8125	15.875 0.6250	-5.8 -0.23	3.5 0.14	36.5 1.44	42.5 1.67	1.3 0.05	58.0 2.28	55.0 2.17	1.2 0.04	1.1 0.05	14.6	10.0	0.0606	0.26 0.57
20.638 0.8125	15.875 0.6250	-5.8 -0.23	0.8 0.03	38.0 1.50	38.5 1.52	1.3 0.05	58.0 2.28	55.0 2.17	1.1 0.04	1.1 0.05	14.6	10.0	0.0606	0.26 0.58
19.050 0.7500	15.875 0.6250	-4.8 -0.19	3.5 0.14	38.0 1.50	44.0 1.73	1.3 0.05	59.0 2.32	56.0 2.20	0.3 0.01	1.8 0.07	14.6	10.0	0.0606	0.26 0.58
20.638 0.8125	15.875 0.6250	-5.8 -0.23	3.5 0.14	36.5 1.44	42.5 1.67	1.3 0.05	59.0 2.32	56.0 2.20	1.2 0.04	1.1 0.05	14.6	10.0	0.0606	0.28 0.61
20.638 0.8125	15.875 0.6250	-5.8 -0.23	0.8 0.03	38.0 1.50	38.5 1.52	1.3 0.05	59.0 2.32	56.0 2.20	1.1 0.04	1.1 0.05	14.6	10.0	0.0606	0.28 0.62
20.638 0.8125	15.875 0.6250	-5.8 -0.23	0.8 0.03	38.0 1.50	38.5 1.52	1.5 0.06	59.0 2.32	55.0 2.17	1.1 0.04	1.1 0.05	14.6	10.0	0.0606	0.28 0.62
25.357 0.9983	20.638 0.8125	-8.6 -0.34	0.8 0.03	37.5 1.48	38.5 1.52	3.3 0.13	62.5 2.46	56.9 2.24	0.8 0.03	0.8 0.04	23.6	9.6	0.0656	0.40 0.89
25.357 0.9983	20.638 0.8125	-8.6 -0.34	0.8 0.03	37.5 1.48	38.5 1.52	0.8 0.03	62.5 2.46	59.9 2.36	0.8 0.03	0.8 0.04	23.6	9.6	0.0656	0.41 0.91
25.357 0.9983	20.638 0.8125	-8.6 -0.34	0.8 0.03	37.5 1.48	38.5 1.52	1.5 0.06	62.0 2.44	58.9 2.32	0.8 0.03	0.8 0.04	23.6	9.6	0.0656	0.41 0.91
25.357 0.9983	20.638 0.8125	-8.6 -0.34	1.3 0.05	39.5 1.56	41.5 1.63	1.5 0.06	62.0 2.44	58.9 2.32	0.8 0.03	0.8 0.04	23.6	9.6	0.0656	0.41 0.91
22.225 0.8750	16.238 0.6393	-5.1 -0.20	0.8 0.03	38.5 1.52	39.0 1.54	1.5 0.06	63.0 2.48	59.0 2.32	1.1 0.04	0.9 0.04	17.5	8.5	0.0681	0.37 0.81
23.812 0.9375	17.462 0.6875	-6.6 -0.26	3.5 0.14	37.5 1.48	44.0 1.73	1.5 0.06	63.0 2.48	60.0 2.36	0.9 0.03	0.3 0.01	18.8	10.5	0.0652	0.38 0.83
22.225 0.8750	17.462 0.6875	-5.1 -0.20	3.5 0.14	38.5 1.52	44.5 1.75	1.5 0.06	63.0 2.48	59.0 2.32	1.1 0.04	0.9 0.04	17.5	8.5	0.0681	0.38 0.82
22.225 0.8750	17.462 0.6875	-7.4 -0.29	1.5 0.06	37.5 1.48	39.5 1.56	0.8 0.03	63.0 2.48	61.0 2.40	0.6 0.02	1.6 0.06	22.7	13.0	0.0650	0.39 0.85
22.225 0.8750	17.462 0.6875	-5.1 -0.20	0.8 0.03	38.5 1.52	39.0 1.54	1.5 0.06	63.0 2.48	59.0 2.32	1.1 0.04	0.9 0.04	17.5	8.5	0.0681	0.38 0.83
22.225 0.8750	17.462 0.6875	-2.8 -0.11	1.5 0.06	40.5 1.59	43.0 1.69	1.5 0.06	65.0 2.56	58.0 2.28	1.7 0.06	1.0 0.04	19.4	10.0	0.0771	0.39 0.87
26.988 1.0625	22.225 0.8750	-8.6 -0.34	1.5 0.06	39.0 1.54	41.0 1.61	1.5 0.06	64.0 2.52	59.0 2.32	1.6 0.06	0.7 0.03	21.9	10.4	0.0697	0.46 1.02

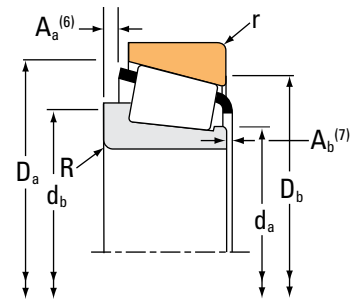
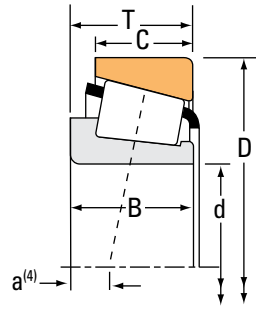
(4) Negative value indicates effective center inside cone (inner-ring) backface.
 (5) These maximum fillet radii will be cleared by the bearing corners.
 (6) Negative value indicates cage extends beyond cone (inner-ring) backface.
 (7) Negative value indicates cage that does not extend beyond cone (inner-ring) front face.

Continued on next page.

TAPERED ROLLER BEARINGS

SINGLE-ROW • TYPE TS

TYPE TS



Bearing Dimensions			Load Ratings						Part Number				
Bore d	O.D. D	Width T	Dynamic ⁽¹⁾		Factors ⁽²⁾		Dynamic ⁽³⁾		Factors ⁽²⁾		Static C ₀	Inner	Outer
			C ₁	e	Y	C ₉₀	C _{a90}	K	N	N			
mm in.	mm in.	mm in.	N lbf			N lbf	N lbf		N lbf				
31.750 1.2500	69.012 2.7170	19.845 0.7813	54600 12300	0.38	1.57	14200 3180	9260 2080	1.53	61700 13900		14125A	14274	
31.750 1.2500	69.012 2.7170	19.845 0.7813	54600 12300	0.38	1.57	14200 3180	9260 2080	1.53	61700 13900		14124	14276	
31.750 1.2500	69.012 2.7170	19.845 0.7813	54600 12300	0.38	1.57	14200 3180	9260 2080	1.53	61700 13900		14125A	14276	
31.750 1.2500	69.012 2.7170	19.845 0.7813	54600 12300	0.38	1.57	14200 3180	9260 2080	1.53	61700 13900		14124	14274	
31.750 1.2500	69.012 2.7170	22.385 0.8813	54600 12300	0.38	1.57	14200 3180	9260 2080	1.53	61700 13900		14124	14277	
31.750 1.2500	69.850 2.7500	23.812 0.9375	83700 18800	0.27	2.19	21700 4880	10200 2280	2.14	94400 21200		2582	2523	
31.750 1.2500	69.850 2.7500	23.812 0.9375	83700 18800	0.27	2.19	21700 4880	10200 2280	2.14	94400 21200		2580	2523	
31.750 1.2500	69.850 2.7500	23.812 0.9375	83700 18800	0.27	2.19	21700 4880	10200 2280	2.14	94400 21200		2580	2523-S	
31.750 1.2500	71.996 2.8345	19.002 0.7481	54600 12300	0.38	1.57	14200 3180	9260 2080	1.53	61700 13900		14124	14282	
31.750 1.2500	72.022 2.8355	23.812 0.9375	83700 18800	0.27	2.19	21700 4880	10200 2280	2.14	94400 21200		2582	2525	
31.750 1.2500	72.233 2.8438	25.400 1.0000	76800 17300	0.55	1.10	19900 4480	18600 4180	1.07	94200 21200		HM88644	HM88610	
31.750 1.2500	72.625 2.8593	25.400 1.0000	76800 17300	0.55	1.10	19900 4480	18600 4180	1.07	94200 21200		HM88644	HM88611AS	
31.750 1.2500	72.625 2.8593	30.162 1.1875	94800 21300	0.33	1.80	24600 5520	14000 3140	1.76	102000 22800		3193	3120	
31.750 1.2500	72.625 2.8593	30.162 1.1875	94800 21300	0.33	1.80	24600 5520	14000 3140	1.76	102000 22800		3188	3120	
31.750 1.2500	72.625 2.8593	30.162 1.1875	94800 21300	0.33	1.80	24600 5520	14000 3140	1.76	102000 22800		3199	3120	
31.750 1.2500	73.025 2.8750	22.225 0.8750	73200 16400	0.37	1.63	19000 4260	12000 2690	1.59	83800 18800		2875	2820	
31.750 1.2500	73.025 2.8750	22.225 0.8750	65700 14800	0.45	1.32	17000 3830	13200 2980	1.29	74900 16800		02875	02820	

⁽¹⁾Based on 1×10^6 revolutions L_{10} life, for the ISO life-calculation method.

⁽²⁾Consult your Timken engineer for instructions on use or review the Timken Engineering Manual on timken.com/catalogs.

⁽³⁾Based on 90×10^6 revolutions L_{10} life, for The Timken Company life-calculation method. C_{90} and C_{a90} are radial and thrust values.

Bearing Dimensions											Geometry Factors			Bearing Weight
Width B	Width C	Eff. Ctr. a ⁽⁴⁾	Shaft			Housing			Cage		G ₁	G ₂	C _g	
			Max Shaft Fillet Radius R ⁽⁵⁾	Backing Shoulder Dia. d _a d _b		Max Housing Fillet Radius r ⁽⁵⁾	Backing Shoulder Dia. D _a D _b		A _a ⁽⁶⁾	A _b ⁽⁷⁾				
mm in.	mm in.	mm in.	mm in.	mm in.	mm in.	mm in.	mm in.	mm in.	mm in.	mm in.				kg lbs.
19.583 0.7710	15.875 0.6250	-4.3 -0.17	3.5 0.14	39.0 1.54	45.0 1.77	3.3 0.13	63.0 2.48	59.0 2.32	1.0 0.04	1.5 0.06	18.0	13.3	0.0668	0.34 0.75
19.583 0.7710	15.875 0.6250	-4.3 -0.17	0.8 0.03	39.0 1.54	39.5 1.56	1.3 0.05	63.0 2.48	60.0 2.36	1.0 0.04	1.5 0.06	18.0	13.3	0.0668	0.34 0.77
19.583 0.7710	15.875 0.6250	-4.3 -0.17	3.5 0.14	39.0 1.54	45.0 1.77	1.3 0.05	63.0 2.48	60.0 2.36	1.0 0.04	1.5 0.06	18.0	13.3	0.0668	0.34 0.77
19.583 0.7710	15.875 0.6250	-4.3 -0.17	0.8 0.03	39.0 1.54	39.5 1.56	3.3 0.13	63.0 2.48	59.0 2.32	1.0 0.04	1.5 0.06	18.0	13.3	0.0668	0.34 0.76
19.583 0.7710	18.415 0.7250	-4.3 -0.17	0.8 0.03	39.0 1.54	39.5 1.56	2.3 0.09	63.0 2.48	59.0 2.32	1.0 0.04	1.5 0.06	18.0	13.3	0.0668	0.37 0.83
25.357 0.9983	19.050 0.7500	-8.6 -0.34	3.5 0.14	37.5 1.48	44.0 1.73	1.3 0.05	64.0 2.52	61.0 2.40	0.8 0.03	0.8 0.04	23.6	9.6	0.0656	0.45 0.99
25.357 0.9983	19.050 0.7500	-8.6 -0.34	0.8 0.03	37.5 1.48	38.5 1.52	1.3 0.05	64.0 2.52	61.0 2.40	0.8 0.03	0.8 0.04	23.6	9.6	0.0656	0.45 1.00
25.357 0.9983	19.050 0.7500	-8.6 -0.34	0.8 0.03	37.5 1.48	38.5 1.52	1.5 0.06	64.0 2.52	61.0 2.40	0.8 0.03	0.8 0.04	23.6	9.6	0.0656	0.45 0.99
19.583 0.7710	15.032 0.5918	-4.3 -0.17	0.8 0.03	39.0 1.54	39.5 1.56	1.5 0.06	65.0 2.56	62.0 2.44	1.0 0.04	1.5 0.06	18.0	13.3	0.0668	0.37 0.84
25.357 0.9983	19.050 0.7500	-8.6 -0.34	3.5 0.14	37.5 1.48	44.0 1.73	0.8 0.03	65.0 2.56	63.0 2.48	0.8 0.03	0.8 0.04	23.6	9.6	0.0656	0.48 1.07
25.400 1.0000	19.842 0.7812	-4.6 -0.18	1.5 0.06	42.5 1.67	44.5 1.75	2.3 0.09	69.0 2.72	60.0 2.36	1.6 0.06	1.7 0.07	23.4	9.4	0.0822	0.51 1.15
25.400 1.0000	19.842 0.7812	-4.6 -0.18	1.5 0.06	42.5 1.67	44.5 1.75	3.3 0.13	69.0 2.72	59.0 2.32	1.6 0.06	1.7 0.07	23.4	9.4	0.0822	0.52 1.16
29.997 1.1810	23.812 0.9375	-10.2 -0.40	3.5 0.14	39.5 1.56	45.5 1.79	3.3 0.13	67.0 2.64	61.0 2.40	1.5 0.06	0.6 0.02	23.4	8.8	0.0697	0.59 1.28
29.997 1.1810	23.812 0.9375	-10.2 -0.40	0.8 0.03	39.5 1.56	40.0 1.57	3.3 0.13	67.0 2.64	61.0 2.40	1.5 0.06	0.6 0.02	23.4	8.8	0.0697	0.59 1.29
29.997 1.1810	23.812 0.9375	-10.2 -0.40	2.3 0.09	39.5 1.56	43.0 1.69	3.3 0.13	67.0 2.64	61.0 2.40	0.0 0.00	0.0 0.00	23.4	8.8	0.0697	0.59 1.28
23.812 0.9375	17.462 0.6875	-5.6 -0.22	3.5 0.14	38.5 1.52	45.0 1.77	3.3 0.13	68.0 2.68	63.0 2.48	0.9 0.03	0.2 0.01	23.1	12.4	0.0718	0.45 1.01
22.225 0.8750	17.462 0.6875	-3.8 -0.15	3.5 0.14	39.5 1.56	45.5 1.79	3.3 0.13	68.0 2.68	62.0 2.44	1.4 0.05	1.0 0.04	20.6	10.1	0.0740	0.44 0.97

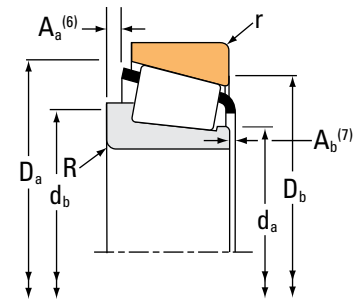
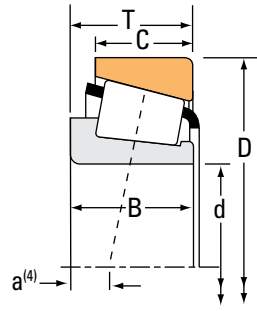
(4) Negative value indicates effective center inside cone (inner-ring) backface.
 (5) These maximum fillet radii will be cleared by the bearing corners.
 (6) Negative value indicates cage extends beyond cone (inner-ring) backface.
 (7) Negative value indicates cage that does not extend beyond cone (inner-ring) front face.

Continued on next page.

TAPERED ROLLER BEARINGS

SINGLE-ROW • TYPE TS

TYPE TS



Bearing Dimensions			Load Ratings							Part Number			
Bore d	O.D. D	Width T	Dynamic ⁽¹⁾		Factors ⁽²⁾		Dynamic ⁽³⁾		Factors ⁽²⁾		Static C ₀	Inner	Outer
			C ₁	e	Y	C ₉₀	C _{a90}	K	N	N			
mm in.	mm in.	mm in.	N lbf			N lbf	N lbf		N lbf				
31.750 1.2500	73.025 2.8750	22.225 0.8750	65700 14800	0.45	1.32	17000 3830	13200 2980	1.29	74900 16800		02876	02820	
31.750 1.2500	73.025 2.8750	22.225 0.8750	73200 16400	0.37	1.63	19000 4260	12000 2690	1.59	83800 18800		2879	2820	
31.750 1.2500	73.025 2.8750	26.988 1.0625	89400 20100	0.37	1.62	23200 5210	14700 3300	1.58	102000 22900		23685	23620	
31.750 1.2500	73.025 2.8750	29.370 1.1563	103000 23200	0.55	1.10	26700 6010	25000 5620	1.07	111000 24900		HM88542	HM88510	
31.750 1.2500	76.200 3.0000	23.812 0.9375	86900 19500	0.30	1.98	22500 5060	11700 2630	1.93	102000 23000		2783	2720	
31.750 1.2500	76.200 3.0000	24.608 0.9688	92000 20700	0.67	0.90	23900 5360	27300 6130	0.87	76200 17100		43125	43300	
31.750 1.2500	76.200 3.0000	29.370 1.1563	110000 24800	0.55	1.10	28600 6440	26800 6020	1.07	119000 26700		HM89440	HM89410	
31.750 1.2500	76.200 3.0000	30.162 1.1875	94800 21300	0.33	1.80	24600 5520	14000 3140	1.76	102000 22800		3193	3129	
31.750 1.2500	76.200 3.0000	30.162 1.1875	94800 21300	0.33	1.80	24600 5520	14000 3140	1.76	102000 22800		3188	3129	
31.750 1.2500	79.375 3.1250	25.400 1.0000	92000 20700	0.67	0.90	23900 5360	27300 6130	0.87	76200 17100		43125	43312	
31.750 1.2500	79.375 3.1250	29.370 1.1563	105000 23500	0.37	1.64	27100 6100	17000 3820	1.60	119000 26800		3476	3420	
31.750 1.2500	80.000 3.1496	24.175 0.9518	94300 21200	0.27	2.20	24400 5490	11400 2570	2.14	83400 18700		346	332A	
31.750 1.2500	80.167 3.1562	26.988 1.0625	94300 21200	0.27	2.20	24400 5490	11400 2570	2.14	83400 18700		346	3320	
31.987 1.2593	66.987 2.6373	20.500 0.8071	63800 14300	0.42	1.44	16500 3720	11800 2650	1.40	70200 15800		02476X	02419	
31.987 1.2593	71.973 2.8336	27.000 1.0630	76800 17300	0.55	1.10	19900 4480	18600 4180	1.07	94200 21200		HM88638	HM88611	
32.000 1.2598	72.000 2.8346	19.000 0.7480	58800 13200	0.36	1.67	15200 3420	9390 2110	1.62	60100 13500		26126X	26283	
32.004 1.2600	72.000 2.8346	19.000 0.7480	58800 13200	0.36	1.67	15200 3420	9390 2110	1.62	60100 13500		26126	26283	

⁽¹⁾Based on 1×10^6 revolutions L_{10} life, for the ISO life-calculation method.

⁽²⁾Consult your Timken engineer for instructions on use or review the Timken Engineering Manual on timken.com/catalogs.

⁽³⁾Based on 90×10^6 revolutions L_{10} life, for The Timken Company life-calculation method. C_{90} and C_{a90} are radial and thrust values.

Bearing Dimensions											Geometry Factors			Bearing Weight
Width B	Width C	Eff. Ctr. a ⁽⁴⁾	Shaft			Housing			Cage		G ₁	G ₂	C _g	
			Max Shaft Fillet Radius R ⁽⁵⁾	Backing Shoulder Dia. d _a d _b		Max Housing Fillet Radius r ⁽⁵⁾	Backing Shoulder Dia. D _a D _b		A _a ⁽⁶⁾	A _b ⁽⁷⁾				
mm in.	mm in.	mm in.	mm in.	mm in.	mm in.	mm in.	mm in.	mm in.	mm in.	mm in.				kg lbs.
22.225 0.8750	17.462 0.6875	-3.8 -0.15	0.8 0.03	39.5 1.56	40.0 1.57	3.3 0.13	68.0 2.68	62.0 2.44	1.4 0.05	1.0 0.04	20.6	10.1	0.0740	0.44 0.99
23.812 0.9375	17.462 0.6875	-5.6 -0.22	0.8 0.03	38.5 1.52	39.5 1.56	3.3 0.13	68.0 2.68	63.0 2.48	0.9 0.03	0.2 0.01	23.1	12.4	0.0718	0.46 1.02
26.975 1.0620	22.225 0.8750	-8.1 -0.32	3.5 0.14	40.0 1.57	46.0 1.81	1.5 0.06	68.0 2.68	63.0 2.48	1.7 0.06	0.8 0.03	24.4	10.7	0.0734	0.55 1.22
27.783 1.0938	23.020 0.9063	-5.6 -0.22	1.3 0.05	42.6 1.68	45.5 1.79	3.3 0.13	70.0 2.76	59.0 2.32	1.9 0.07	1.8 0.08	26.3	8.7	0.0857	0.61 1.35
25.654 1.0100	19.050 0.7500	-8.1 -0.32	1.5 0.06	38.5 1.52	41.0 1.61	3.3 0.13	70.0 2.76	66.0 2.60	1.4 0.05	0.9 0.04	28.7	12.2	0.0725	0.57 1.25
24.074 0.9478	16.670 0.6563	-2.0 -0.08	1.5 0.06	41.5 1.63	44.0 1.73	3.3 0.13	73.0 2.87	64.0 2.52	3.4 0.13	2.4 0.10	16.8	7.6	0.0774	0.52 1.12
28.575 1.1250	23.020 0.9063	-5.6 -0.22	0.8 0.03	44.5 1.75	45.5 1.79	3.3 0.13	73.0 2.87	62.0 2.44	1.9 0.07	1.4 0.06	28.9	9.9	0.0883	0.68 1.50
29.997 1.1810	23.812 0.9375	-10.2 -0.40	3.5 0.14	39.5 1.56	45.5 1.79	0.8 0.03	69.0 2.72	65.0 2.56	1.5 0.06	0.6 0.02	23.4	8.8	0.0697	0.67 1.47
29.997 1.1810	23.812 0.9375	-10.2 -0.40	0.8 0.03	39.5 1.56	40.0 1.57	0.8 0.03	69.0 2.72	65.0 2.56	1.5 0.06	0.6 0.02	23.4	8.8	0.0697	0.67 1.48
24.074 0.9478	17.462 0.6875	-2.0 -0.08	1.5 0.06	41.5 1.63	44.0 1.73	1.5 0.06	74.0 2.91	67.0 2.64	3.4 0.13	2.4 0.10	16.8	7.6	0.0774	0.59 1.28
29.771 1.1721	23.812 0.9375	-8.6 -0.34	1.3 0.05	41.0 1.61	43.0 1.69	3.3 0.13	74.0 2.91	67.0 2.64	1.4 0.05	1.0 0.04	29.9	11.2	0.0781	0.74 1.64
22.403 0.8820	21.000 0.8268	-6.4 -0.25	0.8 0.03	39.5 1.56	40.0 1.57	2.3 0.09	75.0 2.95	71.0 2.80	0.7 0.02	1.1 0.05	26.5	13.0	0.0676	0.59 1.31
22.403 0.8820	23.812 0.9375	-6.4 -0.25	0.8 0.03	39.5 1.56	40.0 1.57	3.3 0.13	75.0 2.95	70.0 2.76	0.7 0.02	1.1 0.05	26.5	13.0	0.0676	0.62 1.38
20.500 0.8071	16.000 0.6299	-5.1 -0.20	0.8 0.03	38.5 1.52	39.5 1.56	1.5 0.06	62.0 2.44	59.0 2.32	1.1 0.04	2.7 0.11	17.5	8.5	0.0681	0.33 0.73
25.400 1.0000	21.443 0.8442	-4.6 -0.18	3.3 0.13	42.5 1.67	48.5 1.91	1.5 0.06	68.0 2.68	61.0 2.40	1.6 0.06	1.7 0.07	23.4	9.4	0.0822	0.54 1.21
18.923 0.7450	15.875 0.6250	-4.1 -0.16	2.0 0.08	37.5 1.48	40.5 1.59	1.5 0.06	65.0 2.56	62.0 2.44	0.5 0.02	1.1 0.05	16.1	10.1	0.0630	0.37 0.81
18.923 0.7450	15.875 0.6250	-4.1 -0.16	1.5 0.06	37.5 1.48	39.5 1.56	1.5 0.06	65.0 2.56	62.0 2.44	0.5 0.02	1.1 0.05	16.1	10.1	0.0630	0.37 0.81

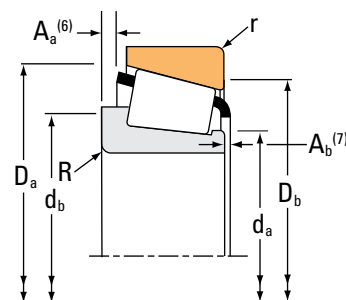
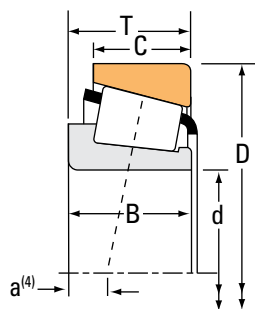
(4) Negative value indicates effective center inside cone (inner-ring) backface.
 (5) These maximum fillet radii will be cleared by the bearing corners.
 (6) Negative value indicates cage extends beyond cone (inner-ring) backface.
 (7) Negative value indicates cage that does not extend beyond cone (inner-ring) front face.

Continued on next page.

TAPERED ROLLER BEARINGS

SINGLE-ROW • TYPE TS

TYPE TS



Bearing Dimensions			Load Ratings						Part Number				
Bore d	O.D. D	Width T	Dynamic ⁽¹⁾		Factors ⁽²⁾		Dynamic ⁽³⁾		Factors ⁽²⁾		Static C ₀	Inner	Outer
			C ₁	e	Y	C ₉₀	C _{a90}	K	N	N			
mm in.	mm in.	mm in.	N lbf			N lbf	N lbf		N lbf				
32.532 1.2808	69.850 2.7500	25.400 1.0000	83700 18800	0.27	2.19	21700 4880	10200 2280	2.14	94400 21200			2584	2523
33.337 1.3125	66.421 2.6150	25.400 1.0000	83700 18800	0.27	2.19	21700 4880	10200 2280	2.14	94400 21200			2585	2520
33.337 1.3125	66.675 2.6250	20.638 0.8125	52500 11800	0.37	1.62	13600 3060	8650 1950	1.57	57900 13000			1680	1620
33.337 1.3125	66.675 2.6250	20.638 0.8125	62400 14000	0.35	1.70	16200 3640	9770 2200	1.66	72800 16400			M38545	M38510
33.337 1.3125	68.262 2.6875	22.225 0.8750	66700 15000	0.28	2.18	17300 3890	8150 1830	2.12	77900 17500			16582	16522
33.337 1.3125	68.262 2.6875	22.225 0.8750	76300 17100	0.55	1.10	19800 4450	18500 4160	1.07	77400 17400			M88048	M88010
33.337 1.3125	68.262 2.6875	22.225 0.8750	76300 17100	0.55	1.10	19800 4450	18500 4160	1.07	77400 17400			M88048	M88012
33.337 1.3125	68.262 2.6875	22.225 0.8750	76300 17100	0.55	1.10	19800 4450	18500 4160	1.07	77400 17400			M88048A	M88010
33.337 1.3125	68.262 2.6875	22.225 0.8750	76300 17100	0.55	1.10	19800 4450	18500 4160	1.07	77400 17400			M88048-S	M88010
33.338 1.3125	69.012 2.7170	19.845 0.7813	54600 12300	0.38	1.57	14200 3180	9260 2080	1.53	61700 13900			14130	14274
33.338 1.3125	69.012 2.7170	19.845 0.7813	54600 12300	0.38	1.57	14200 3180	9260 2080	1.53	61700 13900			14131	14276
33.338 1.3125	69.012 2.7170	19.845 0.7813	54600 12300	0.38	1.57	14200 3180	9260 2080	1.53	61700 13900			14131	14274
33.338 1.3125	69.012 2.7170	19.845 0.7813	54600 12300	0.38	1.57	14200 3180	9260 2080	1.53	61700 13900			14130	14276
33.337 1.3125	69.723 2.7450	19.050 0.7500	69600 15700	0.36	1.67	18100 4060	11100 2500	1.62	60100 13500			26132	26274
33.337 1.3125	69.850 2.7500	23.812 0.9375	83700 18800	0.27	2.19	21700 4880	10200 2280	2.14	94400 21200			2585	2523
33.337 1.3125	69.850 2.7500	23.812 0.9375	83700 18800	0.27	2.19	21700 4880	10200 2280	2.14	94400 21200			2581	2523
33.337 1.3125	69.850 2.7500	23.812 0.9375	83700 18800	0.27	2.19	21700 4880	10200 2280	2.14	94400 21200			2585	2523-S

⁽¹⁾Based on 1 x 10⁶ revolutions L₁₀ life, for the ISO life-calculation method.

⁽²⁾Consult your Timken engineer for instructions on use or review the Timken Engineering Manual on timken.com/catalogs.

⁽³⁾Based on 90 x 10⁶ revolutions L₁₀ life, for The Timken Company life-calculation method. C₉₀ and C_{a90} are radial and thrust values.

Bearing Dimensions											Geometry Factors			Bearing Weight
Width B	Width C	Eff. Ctr. a ⁽⁴⁾	Shaft			Housing			Cage		G ₁	G ₂	C _g	
			Max Shaft Fillet Radius R ⁽⁵⁾	Backing Shoulder Dia. d _a	Backing Shoulder Dia. d _b	Max Housing Fillet Radius r ⁽⁵⁾	Backing Shoulder Dia. D _a	Backing Shoulder Dia. D _b	A _a ⁽⁶⁾	A _b ⁽⁷⁾				
mm in.	mm in.	mm in.	mm in.	mm in.	mm in.	mm in.	mm in.	mm in.	mm in.	mm in.				kg lbs.
26.944 1.0608	19.050 0.7500	-10.2 -0.40	5.0 0.20	38.0 1.50	47.5 1.87	1.3 0.05	64.0 2.52	61.0 2.40	2.4 0.09	0.8 0.04	23.6	9.6	0.0656	0.45 0.98
25.357 0.9983	20.638 0.8125	-8.6 -0.34	3.5 0.14	39.0 1.54	45.0 1.77	3.3 0.13	62.5 2.46	56.9 2.24	0.8 0.03	0.8 0.04	23.6	9.6	0.0656	0.39 0.85
20.638 0.8125	15.875 0.6250	-5.3 -0.21	3.5 0.14	38.5 1.52	44.5 1.75	1.5 0.06	61.0 2.40	58.0 2.28	* *	* *	16.6	8.7	0.0644	0.31 0.68
20.638 0.8125	16.670 0.6563	-5.6 -0.22	3.5 0.14	39.0 1.54	45.0 1.77	2.3 0.09	62.0 2.44	58.0 2.28	0.4 0.01	2.4 0.10	20.3	12.9	0.0680	0.32 0.71
22.225 0.8750	17.462 0.6875	-7.4 -0.29	1.5 0.06	38.5 1.52	41.0 1.61	0.8 0.03	63.0 2.48	61.0 2.40	0.6 0.02	1.6 0.06	22.7	13.0	0.0650	0.38 0.82
22.225 0.8750	17.462 0.6875	-2.8 -0.11	0.8 0.03	41.2 1.62	42.5 1.67	1.5 0.06	65.0 2.56	58.0 2.28	1.4 0.05	1.0 0.04	19.4	10.0	0.0771	0.38 0.84
22.225 0.8750	17.462 0.6875	-2.8 -0.11	0.8 0.03	41.2 1.62	42.5 1.67	0.8 0.03	64.0 2.52	59.0 2.32	1.4 0.05	1.0 0.04	19.4	10.0	0.0771	0.39 0.84
22.225 0.8750	17.462 0.6875	-2.8 -0.11	1.3 0.05	41.2 1.62	43.5 1.71	1.5 0.06	65.0 2.56	58.0 2.28	1.4 0.05	1.0 0.04	19.4	10.0	0.0771	0.38 0.84
22.225 0.8750	17.462 0.6875	-2.8 -0.11	4.0 0.16	41.2 1.62	49.5 1.95	1.5 0.06	65.0 2.56	58.0 2.28	1.4 0.05	1.0 0.04	19.4	10.0	0.0771	0.37 0.83
19.583 0.7710	15.875 0.6250	-4.3 -0.17	3.5 0.14	40.0 1.57	46.5 1.83	3.3 0.13	63.0 2.48	59.0 2.32	1.0 0.04	1.5 0.06	18.0	13.3	0.0668	0.33 0.74
19.583 0.7710	15.875 0.6250	-4.3 -0.17	0.8 0.03	40.0 1.57	41.0 1.61	1.3 0.05	63.0 2.48	60.0 2.36	1.0 0.04	1.5 0.06	18.0	13.3	0.0668	0.33 0.75
19.583 0.7710	15.875 0.6250	-4.3 -0.17	0.8 0.03	40.0 1.57	41.0 1.61	3.3 0.13	63.0 2.48	59.0 2.32	1.0 0.04	1.5 0.06	18.0	13.3	0.0668	0.33 0.73
19.583 0.7710	15.875 0.6250	-4.3 -0.17	3.5 0.14	40.0 1.57	46.5 1.83	1.3 0.05	63.0 2.48	60.0 2.36	1.0 0.04	1.5 0.06	18.0	13.3	0.0668	0.33 0.76
18.923 0.7450	19.050 0.7500	-4.1 -0.16	1.5 0.06	38.5 1.52	40.5 1.59	1.5 0.06	64.9 2.56	61.0 2.40	0.5 0.02	1.1 0.05	16.1	10.1	0.0630	0.34 0.76
25.357 0.9983	19.050 0.7500	-8.6 -0.34	3.5 0.14	39.0 1.54	45.0 1.77	1.3 0.05	64.0 2.52	61.0 2.40	0.8 0.03	0.8 0.04	23.6	9.6	0.0656	0.44 0.96
25.357 0.9983	19.050 0.7500	-8.6 -0.34	0.8 0.03	39.0 1.54	39.5 1.56	1.3 0.05	64.0 2.52	61.0 2.40	0.8 0.03	0.8 0.04	23.6	9.6	0.0656	0.44 0.96
25.357 0.9983	19.050 0.7500	-8.6 -0.34	3.5 0.14	39.0 1.54	45.0 1.77	1.5 0.06	64.0 2.52	61.0 2.40	0.8 0.03	0.8 0.04	23.6	9.6	0.0656	0.44 0.95

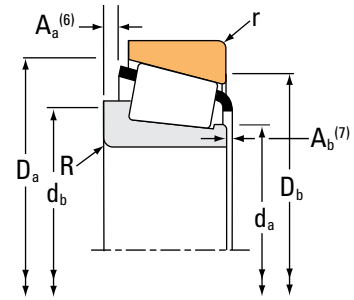
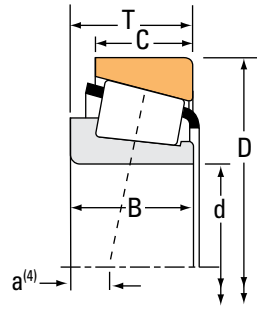
(4) Negative value indicates effective center inside cone (inner-ring) backface.
 (5) These maximum fillet radii will be cleared by the bearing corners.
 (6) Negative value indicates cage extends beyond cone (inner-ring) backface.
 (7) Negative value indicates cage that does not extend beyond cone (inner-ring) front face.
 (*) Contact your Timken engineer for details.

Continued on next page.

TAPERED ROLLER BEARINGS

SINGLE-ROW • TYPE TS

TYPE TS



Bearing Dimensions			Load Ratings							Part Number			
Bore d	O.D. D	Width T	Dynamic ⁽¹⁾		Factors ⁽²⁾		Dynamic ⁽³⁾		Factors ⁽²⁾		Static C ₀	Inner	Outer
			C ₁	e	Y	C ₉₀	C _{a90}	K	N	N			
mm in.	mm in.	mm in.	N lbf			N lbf	N lbf		N lbf				
33.337 1.3125	69.850 2.7500	23.812 0.9375	83700 18800	0.27	2.19	21700 4880	10200 2280	2.14	94400 21200		2581	2523-S	
33.338 1.3125	71.996 2.8345	19.002 0.7481	54600 12300	0.38	1.57	14200 3180	9260 2080	1.53	61700 13900		14130	14282	
33.337 1.3125	72.000 2.8346	19.000 0.7480	69600 15700	0.36	1.67	18100 4060	11100 2500	1.62	60100 13500		26131	26283	
33.337 1.3125	72.000 2.8346	19.000 0.7480	69600 15700	0.36	1.67	18100 4060	11100 2500	1.62	60100 13500		26131	26283-S	
33.337 1.3125	72.238 2.8440	20.638 0.8125	56600 12700	0.40	1.49	14700 3300	10100 2270	1.45	65800 14800		16131	16284	
33.337 1.3125	72.625 2.8593	30.162 1.1875	94800 21300	0.33	1.80	24600 5520	14000 3140	1.76	102000 22800		3197	3120	
33.337 1.3125	72.625 2.8593	30.162 1.1875	94800 21300	0.33	1.80	24600 5520	14000 3140	1.76	102000 22800		3196	3120	
33.337 1.3125	73.025 2.8750	23.812 0.9375	86900 19500	0.30	1.98	22500 5060	11700 2630	1.93	102000 23000		2790	2735X	
33.337 1.3125	73.025 2.8750	29.370 1.1563	103000 23200	0.55	1.10	26700 6010	25000 5620	1.07	111000 24900		HM88547	HM88510	
33.337 1.3125	73.025 2.8750	29.370 1.1563	103000 23200	0.55	1.10	26700 6010	25000 5620	1.07	111000 24900		HM88547	HM88511	
33.337 1.3125	73.812 2.9060	29.370 1.1563	103000 23200	0.55	1.10	26700 6010	25000 5620	1.07	111000 24900		HM88547	HM88512	
33.337 1.3125	76.200 3.0000	22.225 0.8750	76300 17100	0.55	1.10	19800 4450	18500 4160	1.07	77400 17400		M88048	M88022	
33.337 1.3125	76.200 3.0000	23.812 0.9375	86900 19500	0.30	1.98	22500 5060	11700 2630	1.93	102000 23000		2790	2729	
33.337 1.3125	76.200 3.0000	23.812 0.9375	86900 19500	0.30	1.98	22500 5060	11700 2630	1.93	102000 23000		2785	2729	
33.337 1.3125	76.200 3.0000	23.812 0.9375	86900 19500	0.30	1.98	22500 5060	11700 2630	1.93	102000 23000		2790	2720	
33.337 1.3125	76.200 3.0000	23.812 0.9375	86900 19500	0.30	1.98	22500 5060	11700 2630	1.93	102000 23000		2785	2720	
33.337 1.3125	76.200 3.0000	29.370 1.1563	94700 21300	0.40	1.49	24600 5520	16900 3800	1.45	107000 24100		31590	31520	

⁽¹⁾Based on 1 x 10⁶ revolutions L₁₀ life, for the ISO life-calculation method.

⁽²⁾Consult your Timken engineer for instructions on use or review the Timken Engineering Manual on timken.com/catalogs.

⁽³⁾Based on 90 x 10⁶ revolutions L₁₀ life, for The Timken Company life-calculation method. C₉₀ and C_{a90} are radial and thrust values.

Bearing Dimensions											Geometry Factors			Bearing Weight
Width B	Width C	Eff. Ctr. a ⁽⁴⁾	Shaft			Housing			Cage		G ₁	G ₂	C _g	
			Max Shaft Fillet Radius R ⁽⁵⁾	Backing Shoulder Dia. d _a	Shoulder Dia. d _b	Max Housing Fillet Radius r ⁽⁵⁾	Backing Shoulder Dia. D _a	Shoulder Dia. D _b	A _a ⁽⁶⁾	A _b ⁽⁷⁾				
mm in.	mm in.	mm in.	mm in.	mm in.	mm in.	mm in.	mm in.	mm in.	mm in.	mm in.				kg lbs.
25.357 0.9983	19.050 0.7500	-8.6 -0.34	0.8 0.03	39.0 1.54	39.5 1.56	1.5 0.06	64.0 2.52	61.0 2.40	0.8 0.03	0.8 0.04	23.6	9.6	0.0656	0.44 0.96
19.583 0.7710	15.032 0.5918	-4.3 -0.17	3.5 0.14	40.0 1.57	46.5 1.83	1.5 0.06	65.0 2.56	62.0 2.44	1.0 0.04	1.5 0.06	18.0	13.3	0.0668	0.36 0.82
18.923 0.7450	15.875 0.6250	-4.1 -0.16	3.5 0.14	38.5 1.52	44.5 1.75	1.5 0.06	65.0 2.56	62.0 2.44	0.5 0.02	1.1 0.05	16.1	10.1	0.0630	0.35 0.78
18.923 0.7450	15.875 0.6250	-4.1 -0.16	3.5 0.14	38.5 1.52	44.5 1.75	2.0 0.08	65.0 2.56	62.0 2.44	0.5 0.02	1.1 0.05	16.1	10.1	0.0630	0.35 0.78
20.638 0.8125	15.875 0.6250	-4.1 -0.16	3.5 0.14	39.5 1.56	46.0 1.81	1.3 0.05	67.0 2.64	63.0 2.48	1.1 0.04	1.1 0.05	20.3	14.5	0.0707	0.39 0.87
29.997 1.1810	23.812 0.9375	-10.2 -0.40	0.8 0.03	40.5 1.59	41.5 1.63	3.3 0.13	67.0 2.64	61.0 2.40	* *	* *	23.4	8.8	0.0697	0.57 1.25
29.997 1.1810	23.812 0.9375	-10.2 -0.40	3.5 0.14	40.5 1.59	47.0 1.85	3.3 0.13	67.0 2.64	61.0 2.40	1.5 0.06	0.6 0.02	23.4	8.8	0.0697	0.57 1.23
25.654 1.0100	19.050 0.7500	-8.1 -0.32	1.5 0.06	40.0 1.57	42.0 1.65	0.8 0.03	69.0 2.72	66.0 2.60	1.4 0.05	0.9 0.04	28.7	12.2	0.0725	0.51 1.12
27.783 1.0938	23.020 0.9063	-5.6 -0.22	0.8 0.03	42.6 1.68	45.5 1.79	3.3 0.13	70.0 2.76	59.0 2.32	1.9 0.07	1.8 0.08	26.3	8.7	0.0857	0.60 1.31
27.783 1.0938	23.020 0.9063	-5.6 -0.22	0.8 0.03	42.6 1.68	45.5 1.79	0.8 0.03	70.0 2.76	62.0 2.44	1.9 0.07	1.8 0.08	26.3	8.7	0.0857	0.60 1.32
27.783 1.0938	23.020 0.9063	-5.6 -0.22	0.8 0.03	42.6 1.68	45.5 1.79	3.3 0.13	70.0 2.76	60.0 2.36	1.9 0.07	1.8 0.08	26.3	8.7	0.0857	0.61 1.34
22.225 0.8750	17.462 0.6875	-2.8 -0.11	0.8 0.03	41.2 1.62	42.5 1.67	0.8 0.03	68.0 2.68	62.0 2.44	1.4 0.05	1.0 0.04	19.4	10.0	0.0771	0.51 1.11
25.654 1.0100	19.050 0.7500	-8.1 -0.32	1.5 0.06	40.0 1.57	42.0 1.65	0.8 0.03	70.0 2.76	68.0 2.68	1.4 0.05	0.9 0.04	28.7	12.2	0.0725	0.57 1.24
25.654 1.0100	19.050 0.7500	-8.1 -0.32	3.5 0.14	40.0 1.57	46.0 1.81	0.8 0.03	70.0 2.76	68.0 2.68	1.4 0.05	0.9 0.04	28.7	12.2	0.0725	0.56 1.23
25.654 1.0100	19.050 0.7500	-8.1 -0.32	1.5 0.06	40.0 1.57	42.0 1.65	3.3 0.13	70.0 2.76	66.0 2.60	1.4 0.05	0.9 0.04	28.7	12.2	0.0725	0.56 1.22
25.654 1.0100	19.050 0.7500	-8.1 -0.32	3.5 0.14	40.0 1.57	46.0 1.81	3.3 0.13	70.0 2.76	66.0 2.60	1.4 0.05	0.9 0.04	28.7	12.2	0.0725	0.55 1.21
28.575 1.1250	23.812 0.9375	-7.6 -0.30	0.8 0.03	42.5 1.67	43.0 1.69	3.3 0.13	72.0 2.83	64.0 2.52	1.6 0.06	1.3 0.05	26.3	9.1	0.0773	0.64 1.41

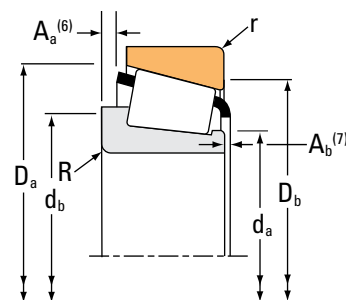
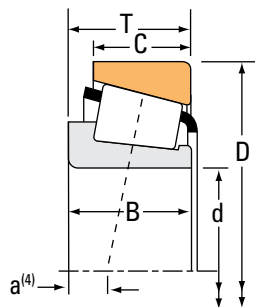
(4) Negative value indicates effective center inside cone (inner-ring) backface.
 (5) These maximum fillet radii will be cleared by the bearing corners.
 (6) Negative value indicates cage extends beyond cone (inner-ring) backface.
 (7) Negative value indicates cage that does not extend beyond cone (inner-ring) front face.
 (*) Contact your Timken engineer for details.

Continued on next page.

TAPERED ROLLER BEARINGS

SINGLE-ROW • TYPE TS

TYPE TS



Bearing Dimensions			Load Ratings							Part Number		
Bore d	O.D. D	Width T	Dynamic ⁽¹⁾		Factors ⁽²⁾		Dynamic ⁽³⁾		Factors ⁽²⁾	Static	Inner	Outer
			C ₁	e	Y	C ₉₀	C _{a90}	K	C ₀			
mm in.	mm in.	mm in.	N lbf			N lbf	N lbf			N lbf		
33.337 1.3125	76.200 3.0000	29.370 1.1563	110000 24800	0.55	1.10	28600 6440	26800 6020	1.07		119000 26700	HM89443	HM89410
33.337 1.3125	76.200 3.0000	29.370 1.1563	110000 24800	0.55	1.10	28600 6440	26800 6020	1.07		119000 26700	HM89444	HM89410
33.337 1.3125	76.200 3.0000	29.370 1.1563	110000 24800	0.55	1.10	28600 6440	26800 6020	1.07		119000 26700	HM89443	HM89411
33.337 1.3125	79.375 3.1250	25.400 1.0000	92000 20700	0.67	0.90	23900 5360	27300 6130	0.87		76200 17100	43131	43312
33.337 1.3125	79.375 3.1250	25.400 1.0000	92000 20700	0.67	0.90	23900 5360	27300 6130	0.87		76200 17100	43132	43312
33.337 1.3125	79.375 3.1250	29.370 1.1563	105000 23500	0.37	1.64	27100 6100	17000 3820	1.60		119000 26800	3477	3420
33.337 1.3125	79.375 3.1250	29.370 1.1563	105000 23500	0.37	1.64	27100 6100	17000 3820	1.60		119000 26800	3483	3420
33.337 1.3125	80.000 3.1496	21.000 0.8268	94300 21200	0.27	2.20	24400 5490	11400 2570	2.14		83400 18700	335-S	332
33.337 1.3125	80.167 3.1562	26.988 1.0625	94300 21200	0.27	2.20	24400 5490	11400 2570	2.14		83400 18700	335-S	3320
33.337 1.3125	88.500 3.4843	25.400 1.0000	99800 22400	0.78	0.77	25900 5810	34600 7770	0.75		88600 19900	44131	44348
34.925 1.3750	65.088 2.5625	18.034 0.7100	64600 14500	0.38	1.59	16700 3760	10800 2430	1.55		63100 14200	LM48548	LM48510
34.925 1.3750	65.088 2.5625	18.034 0.7100	64600 14500	0.38	1.59	16700 3760	10800 2430	1.55		63100 14200	LM48549X	LM48510
34.925 1.3750	65.088 2.5625	18.034 0.7100	64600 14500	0.38	1.59	16700 3760	10800 2430	1.55		63100 14200	LM48549	LM48510
34.925 1.3750	65.088 2.5625	18.034 0.7100	64600 14500	0.38	1.59	16700 3760	10800 2430	1.55		63100 14200	LM48548A	LM48510
34.925 1.3750	65.088 2.5625	21.082 0.8300	64600 14500	0.38	1.59	16700 3760	10800 2430	1.55		63100 14200	LM48548A	LM48511A
34.925 1.3750	65.088 2.5625	21.082 0.8300	64600 14500	0.38	1.59	16700 3760	10800 2430	1.55		63100 14200	LM48548	LM48511A
34.925 1.3750	65.987 2.5979	20.638 0.8125	62400 14000	0.35	1.70	16200 3640	9770 2200	1.66		72800 16400	M38549	M38511

⁽¹⁾Based on 1×10^6 revolutions L_{10} life, for the ISO life-calculation method.

⁽²⁾Consult your Timken engineer for instructions on use or review the Timken Engineering Manual on timken.com/catalogs.

⁽³⁾Based on 90×10^6 revolutions L_{10} life, for The Timken Company life-calculation method. C_{90} and C_{a90} are radial and thrust values.

Bearing Dimensions											Geometry Factors			Bearing Weight
Width B	Width C	Eff. Ctr. a ⁽⁴⁾	Shaft			Housing			Cage		G ₁	G ₂	C _g	
			Max Shaft Fillet Radius R ⁽⁵⁾	Backing Shoulder Dia. d _a	Backing Shoulder Dia. d _b	Max Housing Fillet Radius r ⁽⁵⁾	Backing Shoulder Dia. D _a	Backing Shoulder Dia. D _b	A _a ⁽⁶⁾	A _b ⁽⁷⁾				
mm in.	mm in.	mm in.	mm in.	mm in.	mm in.	mm in.	mm in.	mm in.	mm in.	mm in.				kg lbs.
28.575 1.1250	23.020 0.9063	-5.6 -0.22	0.8 0.03	44.5 1.75	46.5 1.83	3.3 0.13	73.0 2.87	62.0 2.44	1.9 0.07	1.4 0.06	28.9	9.9	0.0883	0.66 1.46
28.575 1.1250	23.020 0.9063	-5.6 -0.22	3.8 0.15	44.5 1.75	53.0 2.09	3.3 0.13	73.0 2.87	62.0 2.44	1.9 0.07	1.4 0.06	28.9	9.9	0.0883	0.65 1.45
28.575 1.1250	23.020 0.9063	-5.6 -0.22	0.8 0.03	44.5 1.75	46.5 1.83	0.8 0.03	73.0 2.87	65.0 2.56	1.9 0.07	1.4 0.06	28.9	9.9	0.0883	0.67 1.48
24.074 0.9478	17.462 0.6875	-2.0 -0.08	3.5 0.14	42.1 1.65	51.0 2.01	1.5 0.06	74.0 2.91	67.0 2.64	3.4 0.13	2.4 0.10	16.8	7.6	0.0774	0.57 1.24
24.074 0.9478	17.462 0.6875	-2.0 -0.08	2.0 0.08	42.1 1.65	48.0 1.89	1.5 0.06	74.0 2.91	67.0 2.64	3.4 0.13	2.4 0.10	16.8	7.6	0.0774	0.57 1.25
29.771 1.1721	23.812 0.9375	-8.6 -0.34	3.5 0.14	42.5 1.67	49.0 1.93	3.3 0.13	74.0 2.91	67.0 2.64	1.4 0.05	1.0 0.04	29.9	11.2	0.0781	0.71 1.58
29.771 1.1721	23.812 0.9375	-8.6 -0.34	0.8 0.03	42.5 1.67	43.0 1.69	3.3 0.13	74.0 2.91	67.0 2.64	1.4 0.05	1.0 0.04	29.9	11.2	0.0781	0.72 1.59
22.403 0.8820	17.826 0.7018	-6.4 -0.25	0.8 0.03	40.5 1.59	41.0 1.61	1.3 0.05	75.0 2.95	73.0 2.87	0.7 0.02	1.1 0.05	26.5	13.0	0.0676	0.54 1.20
22.403 0.8820	23.812 0.9375	-6.4 -0.25	0.8 0.03	40.5 1.59	41.0 1.61	3.3 0.13	75.0 2.95	70.0 2.76	0.7 0.02	1.1 0.05	26.5	13.0	0.0676	0.61 1.35
23.698 0.9330	17.462 0.6875	2.3 0.09	2.0 0.08	48.0 1.89	51.0 2.01	1.5 0.06	84.0 3.31	75.0 2.95	3.8 0.15	2.7 0.11	22.9	8.7	0.0899	0.76 1.67
18.288 0.7200	13.970 0.5500	-3.6 -0.14	3.5 0.14	41.5 1.63	48.0 1.89	1.3 0.05	61.0 2.40	58.0 2.28	0.7 0.02	1.3 0.05	18.0	10.6	0.0666	0.25 0.54
18.288 0.7200	13.970 0.5500	-3.6 -0.14	2.3 0.09	40.0 1.57	43.5 1.71	1.3 0.05	61.0 2.40	58.0 2.28	0.8 0.03	1.1 0.05	18.0	10.6	0.0666	0.26 0.55
18.288 0.7200	13.970 0.5500	-3.6 -0.14	1.5 0.06	40.0 1.57	42.0 1.65	1.3 0.05	61.0 2.40	58.0 2.28	0.8 0.03	1.1 0.05	18.0	10.6	0.0666	0.26 0.56
18.288 0.7200	13.970 0.5500	-3.6 -0.14	0.8 0.03	42.2 1.66	40.5 1.59	1.3 0.05	61.0 2.40	58.0 2.28	0.7 0.02	1.3 0.05	18.0	10.6	0.0666	0.26 0.56
18.288 0.7200	17.018 0.6700	-3.6 -0.14	0.8 0.03	42.2 1.66	40.5 1.59	1.5 0.06	61.0 2.40	58.0 2.28	0.7 0.02	1.3 0.05	18.0	10.6	0.0666	0.28 0.61
18.288 0.7200	17.018 0.6700	-3.6 -0.14	3.5 0.14	41.5 1.63	48.0 1.89	1.5 0.06	61.0 2.40	58.0 2.28	0.7 0.02	1.3 0.05	18.0	10.6	0.0666	0.27 0.59
20.638 0.8125	16.670 0.6563	-5.6 -0.22	3.5 0.14	40.0 1.57	46.5 1.83	2.3 0.09	62.0 2.44	58.0 2.28	0.4 0.01	2.4 0.10	20.3	12.9	0.0680	0.30 0.66

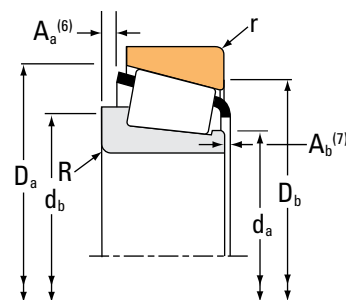
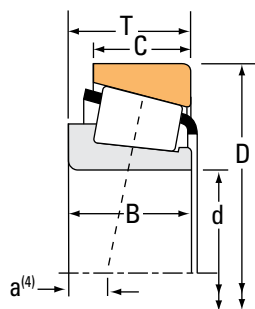
(4) Negative value indicates effective center inside cone (inner-ring) backface.
 (5) These maximum fillet radii will be cleared by the bearing corners.
 (6) Negative value indicates cage extends beyond cone (inner-ring) backface.
 (7) Negative value indicates cage that does not extend beyond cone (inner-ring) front face.

Continued on next page.

TAPERED ROLLER BEARINGS

SINGLE-ROW • TYPE TS

TYPE TS



Bearing Dimensions			Load Ratings						Part Number				
Bore d	O.D. D	Width T	Dynamic ⁽¹⁾		Factors ⁽²⁾		Dynamic ⁽³⁾		Factors ⁽²⁾		Static C ₀	Inner	Outer
			C ₁	e	Y	C ₉₀	C _{a90}	K					
mm in.	mm in.	mm in.	N lbf			N lbf	N lbf		N lbf				
34.925 1.3750	66.675 2.6250	20.638 0.8125	62400 14000	0.35	1.70	16200 3640	9770 2200	1.66	72800 16400		M38549	M38510	
34.925 1.3750	68.262 2.6875	18.034 0.7100	64600 14500	0.38	1.59	16700 3760	10800 2430	1.55	63100 14200		LM48548	LM48514	
34.925 1.3750	68.262 2.6875	20.638 0.8125	59200 13300	0.35	1.70	15400 3450	9270 2080	1.66	68100 15300		14585	14525	
34.925 1.3750	68.262 2.6875	20.638 0.8125	62400 14000	0.35	1.70	16200 3640	9770 2200	1.66	72800 16400		M38549	M38514	
34.925 1.3750	69.012 2.7170	19.845 0.7813	54600 12300	0.38	1.57	14200 3180	9260 2080	1.53	61700 13900		14138A	14274	
34.925 1.3750	69.012 2.7170	19.845 0.7813	54600 12300	0.38	1.57	14200 3180	9260 2080	1.53	61700 13900		14137A	14276	
34.925 1.3750	69.012 2.7170	19.845 0.7813	54600 12300	0.38	1.57	14200 3180	9260 2080	1.53	61700 13900		14138A	14276	
34.925 1.3750	69.012 2.7170	19.845 0.7813	54600 12300	0.38	1.57	14200 3180	9260 2080	1.53	61700 13900		14137A	14274	
34.925 1.3750	69.012 2.7170	22.385 0.8813	54600 12300	0.38	1.57	14200 3180	9260 2080	1.53	61700 13900		14138A	14277	
34.925 1.3750	69.850 2.7500	19.845 0.7813	54600 12300	0.38	1.57	14200 3180	9260 2080	1.53	61700 13900		14137A	14275A	
34.925 1.3750	71.973 2.8336	27.000 1.0630	76800 17300	0.55	1.10	19900 4480	18600 4180	1.07	94200 21200		HM88649	HM88611	
34.925 1.3750	72.233 2.8438	25.400 1.0000	76800 17300	0.55	1.10	19900 4480	18600 4180	1.07	94200 21200		HM88649	HM88610	
34.925 1.3750	72.233 2.8438	25.400 1.0000	76800 17300	0.55	1.10	19900 4480	18600 4180	1.07	94200 21200		HM88649A	HM88610	
34.925 1.3750	72.238 2.8440	20.638 0.8125	56600 12700	0.40	1.49	14700 3300	10100 2270	1.45	65800 14800		16137	16284	
34.925 1.3750	72.625 2.8593	25.400 1.0000	76800 17300	0.55	1.10	19900 4480	18600 4180	1.07	94200 21200		HM88649	HM88611AS	
34.925 1.3750	73.025 2.8750	22.225 0.8750	73200 16400	0.37	1.63	19000 4260	12000 2690	1.59	83800 18800		2877	2820	
34.925 1.3750	73.025 2.8750	22.225 0.8750	65700 14800	0.45	1.32	17000 3830	13200 2980	1.29	74900 16800		02877	02820	

⁽¹⁾Based on 1 x 10⁶ revolutions L₁₀ life, for the ISO life-calculation method.

⁽²⁾Consult your Timken engineer for instructions on use or review the Timken Engineering Manual on timken.com/catalogs.

⁽³⁾Based on 90 x 10⁶ revolutions L₁₀ life, for The Timken Company life-calculation method. C₉₀ and C_{a90} are radial and thrust values.

Bearing Dimensions											Geometry Factors			Bearing Weight
Width B	Width C	Eff. Ctr. a ⁽⁴⁾	Shaft			Housing			Cage		G ₁	G ₂	C _g	
			Max Shaft Fillet Radius R ⁽⁵⁾	Backing Shoulder Dia. d _a	Backing Shoulder Dia. d _b	Max Housing Fillet Radius r ⁽⁵⁾	Backing Shoulder Dia. D _a	Backing Shoulder Dia. D _b	A _a ⁽⁶⁾	A _b ⁽⁷⁾				
mm in.	mm in.	mm in.	mm in.	mm in.	mm in.	mm in.	mm in.	mm in.	mm in.	mm in.				kg lbs.
20.638 0.8125	16.670 0.6563	-5.6 -0.22	3.5 0.14	40.0 1.57	46.5 1.83	2.3 0.09	62.0 2.44	58.0 2.28	0.4 0.01	2.4 0.10	20.3	12.9	0.0680	0.31 0.68
18.288 0.7200	13.970 0.5500	-3.6 -0.14	3.5 0.14	41.5 1.63	48.0 1.89	1.3 0.05	63.0 2.48	59.0 2.32	0.7 0.02	1.3 0.05	18.0	10.6	0.0666	0.28 0.62
20.638 0.8125	15.875 0.6250	-5.8 -0.23	3.5 0.14	40.0 1.57	46.0 1.81	2.3 0.09	63.0 2.48	59.0 2.32	0.7 0.03	2.2 0.09	19.5	12.3	0.0670	0.32 0.71
20.638 0.8125	16.670 0.6563	-5.6 -0.22	3.5 0.14	40.0 1.57	46.5 1.83	2.3 0.09	63.0 2.48	59.0 2.32	0.4 0.01	2.4 0.10	20.3	12.9	0.0680	0.33 0.73
19.583 0.7710	15.875 0.6250	-4.3 -0.17	3.5 0.14	41.5 1.63	48.0 1.89	3.3 0.13	63.0 2.48	59.0 2.32	1.0 0.04	1.5 0.06	18.0	13.3	0.0668	0.32 0.70
19.583 0.7710	15.875 0.6250	-4.3 -0.17	1.5 0.06	41.5 1.63	43.5 1.71	1.3 0.05	63.0 2.48	60.0 2.36	1.0 0.04	1.5 0.06	18.0	13.3	0.0668	0.32 0.72
19.583 0.7710	15.875 0.6250	-4.3 -0.17	3.5 0.14	41.5 1.63	48.0 1.89	1.3 0.05	63.0 2.48	60.0 2.36	1.0 0.04	1.5 0.06	18.0	13.3	0.0668	0.32 0.71
19.583 0.7710	15.875 0.6250	-4.3 -0.17	1.5 0.06	41.5 1.63	43.5 1.71	3.3 0.13	63.0 2.48	59.0 2.32	1.0 0.04	1.5 0.06	18.0	13.3	0.0668	0.32 0.70
19.583 0.7710	18.415 0.7250	-4.3 -0.17	3.5 0.14	41.5 1.63	48.0 1.89	2.3 0.09	63.0 2.48	59.0 2.32	1.0 0.04	1.5 0.06	18.0	13.3	0.0668	0.35 0.77
19.583 0.7710	15.875 0.6250	-4.3 -0.17	1.5 0.06	41.5 1.63	43.5 1.71	1.5 0.06	64.0 2.52	60.0 2.36	1.0 0.04	1.5 0.06	18.0	13.3	0.0668	0.33 0.74
25.400 1.0000	21.443 0.8442	-4.6 -0.18	2.3 0.09	42.5 1.68	48.5 1.91	1.5 0.06	68.0 2.68	61.0 2.40	1.6 0.06	1.7 0.07	23.4	9.4	0.0822	0.51 1.14
25.400 1.0000	19.842 0.7812	-4.6 -0.18	2.3 0.09	42.5 1.68	48.5 1.91	2.3 0.09	69.0 2.72	60.0 2.36	1.6 0.06	1.7 0.07	23.4	9.4	0.0822	0.48 1.08
25.400 1.0000	19.842 0.7812	-4.6 -0.18	3.5 0.14	43.0 1.69	51.0 2.01	2.3 0.09	69.0 2.72	60.0 2.36	1.6 0.06	1.7 0.07	23.4	9.4	0.0822	0.48 1.07
20.638 0.8125	15.875 0.6250	-4.1 -0.16	3.5 0.14	40.5 1.59	47.0 1.85	1.3 0.05	67.0 2.64	63.0 2.48	1.1 0.04	1.1 0.05	20.3	14.5	0.0707	0.38 0.84
25.400 1.0000	19.842 0.7812	-4.6 -0.18	2.3 0.09	42.5 1.68	48.5 1.91	3.3 0.13	69.0 2.72	59.0 2.32	1.6 0.06	1.7 0.07	23.4	9.4	0.0822	0.49 1.08
23.812 0.9375	17.462 0.6875	-5.6 -0.22	3.5 0.14	41.0 1.61	47.5 1.87	3.3 0.13	68.0 2.68	63.0 2.48	0.9 0.03	0.2 0.01	23.1	12.4	0.0718	0.42 0.94
22.225 0.8750	17.462 0.6875	-3.8 -0.15	3.5 0.14	42.0 1.65	48.5 1.91	3.3 0.13	68.0 2.68	62.0 2.44	1.4 0.05	1.0 0.04	20.6	10.1	0.0740	0.41 0.91

⁽⁴⁾Negative value indicates effective center inside cone (inner-ring) backface.

⁽⁵⁾These maximum fillet radii will be cleared by the bearing corners.

⁽⁶⁾Negative value indicates cage extends beyond cone (inner-ring) backface.

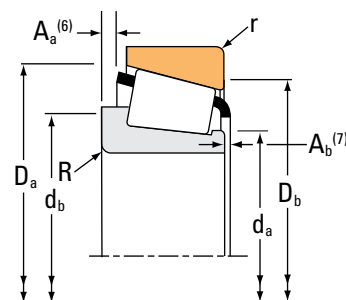
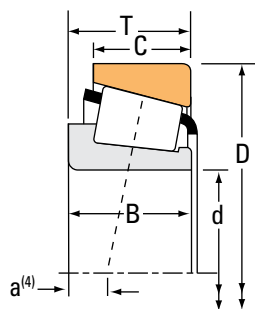
⁽⁷⁾Negative value indicates cage that does not extend beyond cone (inner-ring) front face.

Continued on next page.

TAPERED ROLLER BEARINGS

SINGLE-ROW • TYPE TS

TYPE TS



Bearing Dimensions			Load Ratings							Part Number		
Bore d	O.D. D	Width T	Dynamic ⁽¹⁾		Factors ⁽²⁾		Dynamic ⁽³⁾		Factors ⁽²⁾	Static	Inner	Outer
			C ₁	e	Y	C ₉₀	C _{a90}	K	C ₀			
mm in.	mm in.	mm in.	N lbf			N lbf	N lbf			N lbf		
34.925 1.3750	73.025 2.8750	22.225 0.8750	73200 16400	0.37	1.63	19000 4260	12000 2690	1.59		83800 18800	2878	2820
34.925 1.3750	73.025 2.8750	22.225 0.8750	65700 14800	0.45	1.32	17000 3830	13200 2980	1.29		74900 16800	02878	02830
34.925 1.3750	73.025 2.8750	22.225 0.8750	73200 16400	0.37	1.63	19000 4260	12000 2690	1.59		83800 18800	2878	2821
34.925 1.3750	73.025 2.8750	22.225 0.8750	65700 14800	0.45	1.32	17000 3830	13200 2980	1.29		74900 16800	02878	02820
34.925 1.3750	73.025 2.8750	23.812 0.9375	85100 19100	0.29	2.07	22100 4960	11000 2460	2.01		97400 21900	25877	25820
34.925 1.3750	73.025 2.8750	23.812 0.9375	85100 19100	0.29	2.07	22100 4960	11000 2460	2.01		97400 21900	25877	25821
34.925 1.3750	73.025 2.8750	23.812 0.9375	85100 19100	0.29	2.07	22100 4960	11000 2460	2.01		97400 21900	25878	25821
34.925 1.3750	73.025 2.8750	23.812 0.9375	85100 19100	0.29	2.07	22100 4960	11000 2460	2.01		97400 21900	25878	25820
34.925 1.3750	73.025 2.8750	23.812 0.9375	86900 19500	0.30	1.98	22500 5060	11700 2630	1.93		102000 23000	2793	2735X
34.925 1.3750	73.025 2.8750	23.812 0.9375	86900 19500	0.30	1.98	22500 5060	11700 2630	1.93		102000 23000	2786	2735X
34.925 1.3750	73.025 2.8750	23.812 0.9375	85100 19100	0.29	2.07	22100 4960	11000 2460	2.01		97400 21900	25877A	25821
34.925 1.3750	73.025 2.8750	26.988 1.0625	89400 20100	0.37	1.62	23200 5210	14700 3300	1.58		102000 22900	23690	23620
34.925 1.3750	76.200 3.0000	23.812 0.9375	86900 19500	0.30	1.98	22500 5060	11700 2630	1.93		102000 23000	2793	2720
34.925 1.3750	76.200 3.0000	23.812 0.9375	86900 19500	0.30	1.98	22500 5060	11700 2630	1.93		102000 23000	2786	2729
34.925 1.3750	76.200 3.0000	23.812 0.9375	86900 19500	0.30	1.98	22500 5060	11700 2630	1.93		102000 23000	2786	2720
34.925 1.3750	76.200 3.0000	23.812 0.9375	86900 19500	0.30	1.98	22500 5060	11700 2630	1.93		102000 23000	2793	2729
34.925 1.3750	76.200 3.0000	23.812 0.9375	86900 19500	0.30	1.98	22500 5060	11700 2630	1.93		102000 23000	2796	2729

⁽¹⁾Based on 1 x 10⁶ revolutions L₁₀ life, for the ISO life-calculation method.

⁽²⁾Consult your Timken engineer for instructions on use or review the Timken Engineering Manual on timken.com/catalogs.

⁽³⁾Based on 90 x 10⁶ revolutions L₁₀ life, for The Timken Company life-calculation method. C₉₀ and C_{a90} are radial and thrust values.

Bearing Dimensions											Geometry Factors			Bearing Weight
Width B	Width C	Eff. Ctr. a ⁽⁴⁾	Shaft			Housing			Cage		G ₁	G ₂	C _g	
			Max Shaft Fillet Radius R ⁽⁵⁾	Backing Shoulder Dia. d _a	Backing Shoulder Dia. d _b	Max Housing Fillet Radius r ⁽⁵⁾	Backing Shoulder Dia. D _a	Backing Shoulder Dia. D _b	A _a ⁽⁶⁾	A _b ⁽⁷⁾				
mm in.	mm in.	mm in.	mm in.	mm in.	mm in.	mm in.	mm in.	mm in.	mm in.	mm in.				kg lbs.
23.812 0.9375	17.462 0.6875	-5.6 -0.22	0.8 0.03	41.0 1.61	42.0 1.65	3.3 0.13	68.0 2.68	63.0 2.48	0.9 0.03	0.2 0.01	23.1	12.4	0.0718	0.43 0.96
22.225 0.8750	17.462 0.6875	-3.8 -0.15	0.8 0.03	42.0 1.65	42.5 1.67	0.8 0.03	68.0 2.68	64.0 2.52	1.4 0.05	1.0 0.04	20.6	10.1	0.0740	0.42 0.94
23.812 0.9375	17.462 0.6875	-5.6 -0.22	0.8 0.03	41.0 1.61	42.0 1.65	0.8 0.03	68.0 2.68	65.0 2.56	0.9 0.03	0.2 0.01	23.1	12.4	0.0718	0.44 0.97
22.225 0.8750	17.462 0.6875	-3.8 -0.15	0.8 0.03	42.0 1.65	42.5 1.67	3.3 0.13	68.0 2.68	62.0 2.44	1.4 0.05	1.0 0.04	20.6	10.1	0.0740	0.41 0.92
24.608 0.9688	19.050 0.7500	-8.1 -0.32	1.5 0.06	40.5 1.59	43.0 1.69	2.3 0.09	68.0 2.68	64.0 2.52	0.9 0.03	1.6 0.07	26.4	10.9	0.0695	0.47 1.03
24.608 0.9688	19.050 0.7500	-8.1 -0.32	1.5 0.06	40.5 1.59	43.0 1.69	0.8 0.03	68.0 2.68	65.0 2.56	0.9 0.03	1.6 0.07	26.4	10.9	0.0695	0.48 1.04
24.608 0.9688	19.050 0.7500	-8.1 -0.32	3.5 0.14	40.5 1.59	47.0 1.85	0.8 0.03	68.0 2.68	65.0 2.56	0.9 0.03	1.6 0.07	26.4	10.9	0.0695	0.47 1.03
24.608 0.9688	19.050 0.7500	-8.1 -0.32	3.5 0.14	40.5 1.59	47.0 1.85	2.3 0.09	68.0 2.68	64.0 2.52	0.9 0.03	1.6 0.07	26.4	10.9	0.0695	0.46 1.02
25.654 1.0100	19.050 0.7500	-8.1 -0.32	0.8 0.03	41.0 1.61	42.0 1.65	0.8 0.03	69.0 2.72	66.0 2.60	1.4 0.05	0.9 0.04	28.7	12.2	0.0725	0.49 1.08
25.654 1.0100	19.050 0.7500	-8.1 -0.32	5.0 0.20	41.0 1.61	51.0 2.01	0.8 0.03	69.0 2.72	66.0 2.60	1.4 0.05	0.9 0.04	28.7	12.2	0.0725	0.48 1.05
24.608 0.9688	19.050 0.7500	-8.1 -0.32	0.8 0.03	42.0 1.65	42.5 1.67	0.8 0.03	68.0 2.68	65.0 2.56	* *	* *	26.4	10.9	0.0695	0.48 1.04
26.975 1.0620	22.225 0.8750	-8.1 -0.32	3.5 0.14	42.1 1.65	49.0 1.93	1.5 0.06	68.0 2.68	63.0 2.48	1.7 0.06	0.8 0.03	24.4	10.7	0.0734	0.52 1.14
25.654 1.0100	19.050 0.7500	-8.1 -0.32	0.8 0.03	41.0 1.61	42.0 1.65	3.3 0.13	70.0 2.76	66.0 2.60	1.4 0.05	0.9 0.04	28.7	12.2	0.0725	0.54 1.18
25.654 1.0100	19.050 0.7500	-8.1 -0.32	5.0 0.20	41.0 1.61	51.0 2.01	0.8 0.03	70.0 2.76	68.0 2.68	1.4 0.05	0.9 0.04	28.7	12.2	0.0725	0.54 1.17
25.654 1.0100	19.050 0.7500	-8.1 -0.32	5.0 0.20	41.0 1.61	51.0 2.01	3.3 0.13	70.0 2.76	66.0 2.60	1.4 0.05	0.9 0.04	28.7	12.2	0.0725	0.53 1.15
25.654 1.0100	19.050 0.7500	-8.1 -0.32	0.8 0.03	41.0 1.61	42.0 1.65	0.8 0.03	70.0 2.76	68.0 2.68	1.4 0.05	0.9 0.04	28.7	12.2	0.0725	0.55 1.20
25.654 1.0100	19.050 0.7500	-8.1 -0.32	3.5 0.14	41.0 1.61	47.5 1.87	0.8 0.03	70.0 2.76	68.0 2.68	1.4 0.05	0.9 0.04	28.7	12.2	0.0725	0.55 1.20

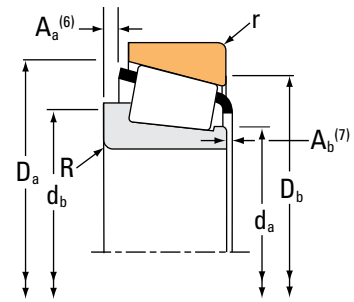
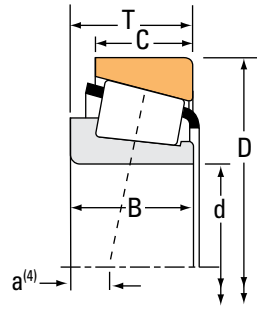
(4) Negative value indicates effective center inside cone (inner-ring) backface.
 (5) These maximum fillet radii will be cleared by the bearing corners.
 (6) Negative value indicates cage extends beyond cone (inner-ring) backface.
 (7) Negative value indicates cage that does not extend beyond cone (inner-ring) front face.
 (*) Contact your Timken engineer for details.

Continued on next page.

TAPERED ROLLER BEARINGS

SINGLE-ROW • TYPE TS

TYPE TS



Bearing Dimensions			Load Ratings							Part Number			
Bore d	O.D. D	Width T	Dynamic ⁽¹⁾		Factors ⁽²⁾		Dynamic ⁽³⁾		Factors ⁽²⁾		Static C ₀	Inner	Outer
			C ₁	e	Y	C ₉₀	C _{a90}	K	N	N			
mm in.	mm in.	mm in.	N lbf			N lbf	N lbf		N lbf				
34.925 1.3750	76.200 3.0000	29.370 1.1563	99900 22500	0.35	1.71	25900 5820	15500 3490	1.67	111000 24900		36137	36300	
34.925 1.3750	76.200 3.0000	29.370 1.1563	94700 21300	0.40	1.49	24600 5520	16900 3800	1.45	107000 24100		31593	31520	
34.925 1.3750	76.200 3.0000	29.370 1.1563	94700 21300	0.40	1.49	24600 5520	16900 3800	1.45	107000 24100		31593	31521	
34.925 1.3750	76.200 3.0000	29.370 1.1563	94700 21300	0.40	1.49	24600 5520	16900 3800	1.45	107000 24100		31594	31520	
34.925 1.3750	76.200 3.0000	29.370 1.1563	110000 24800	0.55	1.10	28600 6440	26800 6020	1.07	119000 26700		HM89446	HM89410	
34.925 1.3750	76.200 3.0000	29.370 1.1563	110000 24800	0.55	1.10	28600 6440	26800 6020	1.07	119000 26700		HM89446A	HM89410	
34.925 1.3750	79.325 3.1230	29.370 1.1563	105000 23500	0.37	1.64	27100 6100	17000 3820	1.60	119000 26800		3482	3426	
34.925 1.3750	79.375 3.1250	29.370 1.1563	105000 23500	0.37	1.64	27100 6100	17000 3820	1.60	119000 26800		3478	3420	
34.925 1.3750	79.375 3.1250	29.370 1.1563	105000 23500	0.37	1.64	27100 6100	17000 3820	1.60	119000 26800		3482	3420	
34.925 1.3750	80.000 3.1496	21.000 0.8268	94300 21200	0.27	2.20	24400 5490	11400 2570	2.14	83400 18700		335	332	
34.925 1.3750	80.000 3.1496	24.175 0.9518	94300 21200	0.27	2.20	24400 5490	11400 2570	2.14	83400 18700		335	332A	
34.925 1.3750	80.035 3.1510	21.433 0.8438	75200 16900	0.40	1.49	19500 4390	13400 3020	1.45	68900 15500		28137	28317	
34.925 1.3750	80.035 3.1510	24.608 0.9688	78000 17500	0.56	1.07	20200 4550	19400 4370	1.04	91100 20500		27875	27820	
34.925 1.3750	80.035 3.1510	29.370 1.1563	115000 25800	0.27	2.20	29800 6700	13900 3130	2.14	129000 29100		3379	3339	
34.925 1.3750	80.167 3.1562	26.988 1.0625	94300 21200	0.27	2.20	24400 5490	11400 2570	2.14	83400 18700		335	3320	
34.925 1.3750	80.167 3.1562	29.367 1.1562	115000 25800	0.27	2.20	29800 6700	13900 3130	2.14	129000 29100		3379	3320	
34.925 1.3750	80.962 3.1875	22.225 0.8750	65700 14800	0.45	1.32	17000 3830	13200 2980	1.29	74900 16800		02877	02831	

⁽¹⁾Based on 1 x 10⁶ revolutions L₁₀ life, for the ISO life-calculation method.

⁽²⁾Consult your Timken engineer for instructions on use or review the Timken Engineering Manual on timken.com/catalogs.

⁽³⁾Based on 90 x 10⁶ revolutions L₁₀ life, for The Timken Company life-calculation method. C₉₀ and C_{a90} are radial and thrust values.

Bearing Dimensions											Geometry Factors			Bearing Weight
Width B	Width C	Eff. Ctr. a ⁽⁴⁾	Shaft			Housing			Cage		G ₁	G ₂	C _g	
			Max Shaft Fillet Radius R ⁽⁵⁾	Backing Shoulder Dia. d _a	Shoulder Dia. d _b	Max Housing Fillet Radius r ⁽⁵⁾	Backing Shoulder Dia. D _a	Shoulder Dia. D _b	A _a ⁽⁶⁾	A _b ⁽⁷⁾				
mm in.	mm in.	mm in.	mm in.	mm in.	mm in.	mm in.	mm in.	mm in.	mm in.	mm in.				kg lbs.
29.845 1.1750	23.812 0.9375	-9.1 -0.36	1.5 0.06	42.5 1.67	45.0 1.77	3.3 0.13	71.0 2.80	66.0 2.60	* *	* *	26.7	10.5	0.0741	0.62 1.37
28.575 1.1250	23.812 0.9375	-7.6 -0.30	3.5 0.14	43.5 1.71	50.0 1.97	3.3 0.13	72.0 2.83	64.0 2.52	1.6 0.06	1.3 0.05	26.3	9.1	0.0773	0.61 1.35
28.575 1.1250	23.812 0.9375	-7.6 -0.30	3.5 0.14	43.5 1.71	50.0 1.97	1.3 0.05	72.0 2.83	66.0 2.60	1.6 0.06	1.3 0.05	26.3	9.1	0.0773	0.62 1.37
28.575 1.1250	23.812 0.9375	-7.6 -0.30	1.5 0.06	43.5 1.71	46.0 1.81	3.3 0.13	72.0 2.83	64.0 2.52	1.6 0.06	1.3 0.05	26.3	9.1	0.0773	0.62 1.36
28.575 1.1250	23.020 0.9063	-5.6 -0.22	3.5 0.14	44.5 1.75	56.0 2.20	3.3 0.13	73.0 2.87	62.0 2.44	1.9 0.07	1.4 0.06	28.9	9.9	0.0883	0.64 1.42
28.575 1.1250	23.020 0.9063	-5.6 -0.22	0.8 0.03	44.5 1.75	47.5 1.87	3.3 0.13	73.0 2.87	62.0 2.44	1.9 0.07	1.4 0.06	28.9	9.9	0.0883	0.64 1.42
29.771 1.1721	23.812 0.9375	-8.6 -0.34	0.8 0.03	43.5 1.71	44.0 1.73	3.3 0.13	74.0 2.91	67.0 2.64	1.4 0.05	1.0 0.04	29.9	11.2	0.0781	0.70 1.55
29.771 1.1721	23.812 0.9375	-8.6 -0.34	3.5 0.14	43.5 1.71	50.0 1.97	3.3 0.13	74.0 2.91	67.0 2.64	1.4 0.05	1.0 0.04	29.9	11.2	0.0781	0.69 1.54
29.771 1.1721	23.812 0.9375	-8.6 -0.34	0.8 0.03	43.5 1.71	44.0 1.73	3.3 0.13	74.0 2.91	67.0 2.64	1.4 0.05	1.0 0.04	29.9	11.2	0.0781	0.70 1.55
22.403 0.8820	17.826 0.7018	-6.4 -0.25	0.8 0.03	41.5 1.63	42.5 1.67	1.3 0.05	75.0 2.95	73.0 2.87	0.7 0.02	1.1 0.05	26.5	13.0	0.0676	0.52 1.17
22.403 0.8820	21.000 0.8268	-6.4 -0.25	0.8 0.03	41.5 1.63	42.5 1.67	2.3 0.09	75.0 2.95	71.0 2.80	0.7 0.02	1.1 0.05	26.5	13.0	0.0676	0.56 1.25
20.940 0.8244	15.875 0.6250	-4.8 -0.19	1.5 0.06	41.0 1.61	43.5 1.71	1.5 0.06	73.0 2.87	69.0 2.72	2.3 0.09	1.1 0.05	20.7	12.5	0.0709	0.49 1.09
23.698 0.9330	18.512 0.7288	-2.5 -0.10	0.8 0.03	44.5 1.75	45.5 1.79	1.5 0.06	75.0 2.95	68.0 2.68	3.2 0.12	1.5 0.06	24.6	12.6	0.0839	0.59 1.31
30.391 1.1965	23.812 0.9375	-10.9 -0.43	3.5 0.14	41.5 1.63	48.0 1.89	1.5 0.06	74.8 2.94	71.0 2.80	1.8 0.07	1.1 0.05	34.6	12.1	0.0744	0.71 1.59
22.403 0.8820	23.812 0.9375	-6.4 -0.25	0.8 0.03	41.5 1.63	42.5 1.67	3.3 0.13	75.0 2.95	70.0 2.76	0.7 0.02	1.1 0.05	26.5	13.0	0.0676	0.59 1.31
30.391 1.1965	23.812 0.9375	-10.9 -0.43	3.5 0.14	41.5 1.63	48.0 1.89	3.3 0.13	75.0 2.95	70.0 2.76	1.8 0.07	1.1 0.05	34.6	12.1	0.0744	0.71 1.58
22.225 0.8750	17.462 0.6875	-3.8 -0.15	3.5 0.14	42.0 1.65	48.5 1.91	0.8 0.03	72.0 2.83	67.0 2.64	1.4 0.05	1.0 0.04	20.6	10.1	0.0740	0.55 1.22

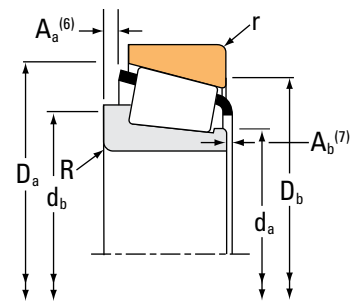
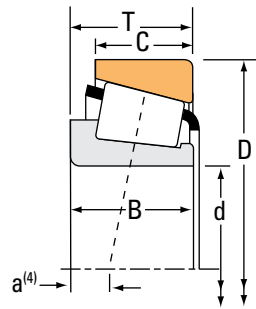
(4) Negative value indicates effective center inside cone (inner-ring) backface.
 (5) These maximum fillet radii will be cleared by the bearing corners.
 (6) Negative value indicates cage extends beyond cone (inner-ring) backface.
 (7) Negative value indicates cage that does not extend beyond cone (inner-ring) front face.
 (*) Contact your Timken engineer for details.

Continued on next page.

TAPERED ROLLER BEARINGS

SINGLE-ROW • TYPE TS

TYPE TS



Bearing Dimensions			Load Ratings							Part Number		
Bore d	O.D. D	Width T	Dynamic ⁽¹⁾		Factors ⁽²⁾		Dynamic ⁽³⁾		Factors ⁽²⁾	Static	Inner	Outer
			C ₁	e	Y	C ₉₀	C _{a90}	K	C ₀			
mm in.	mm in.	mm in.	N lbf			N lbf	N lbf			N lbf		
34.925 1.3750	81.755 3.2187	29.370 1.1563	115000 25800	0.27	2.20	29800 6700	13900 3130	2.14	129000 29100	3379	3329	
34.925 1.3750	84.138 3.3125	29.370 1.1563	115000 25800	0.27	2.20	29800 6700	13900 3130	2.14	129000 29100	3379	3328	
34.925 1.3750	85.725 3.3750	30.162 1.1875	124000 27900	0.40	1.49	32200 7240	22200 4980	1.45	148000 33200	3872	3821	
34.925 1.3750	85.725 3.3750	30.162 1.1875	124000 27900	0.40	1.49	32200 7240	22200 4980	1.45	148000 33200	3872A	3820	
34.925 1.3750	85.725 3.3750	30.162 1.1875	124000 27900	0.40	1.49	32200 7240	22200 4980	1.45	148000 33200	3872	3820	
34.925 1.3750	87.312 3.4375	30.162 1.1875	113000 25500	0.31	1.96	29400 6610	15400 3460	1.91	134000 30100	3581	3525	
34.925 1.3750	88.500 3.4843	26.988 1.0625	116000 26000	0.26	2.28	30000 6740	13500 3040	2.22	124000 28000	417	414	
34.925 1.3750	90.488 3.5625	39.688 1.5625	199000 44700	0.28	2.11	51500 11600	25100 5640	2.05	204000 45900	4368	4335	
34.925 1.3750	95.250 3.7500	27.783 1.0938	127000 28500	0.28	2.11	32900 7400	16000 3600	2.05	144000 32400	449	432	
34.976 1.3770	68.000 2.6772	16.019 0.6307	50700 11400	0.44	1.35	13100 2960	10000 2250	1.31	57800 13000	19138	19267X	
34.976 1.3770	68.262 2.6875	15.875 0.6250	50700 11400	0.44	1.35	13100 2960	10000 2250	1.31	57800 13000	19138	19268	
34.976 1.3770	69.012 2.7170	19.845 0.7813	54600 12300	0.38	1.57	14200 3180	9260 2080	1.53	61700 13900	14139	14274	
34.976 1.3770	69.012 2.7170	19.845 0.7813	54600 12300	0.38	1.57	14200 3180	9260 2080	1.53	61700 13900	14139	14276	
34.976 1.3770	71.996 2.8345	19.002 0.7481	54600 12300	0.38	1.57	14200 3180	9260 2080	1.53	61700 13900	14139	14282	
34.976 1.3770	72.000 2.8346	17.018 0.6700	50700 11400	0.44	1.35	13100 2960	10000 2250	1.31	57800 13000	19138	19283	
34.976 1.3770	72.085 2.8380	22.385 0.8813	54600 12300	0.38	1.57	14200 3180	9260 2080	1.53	61700 13900	14139	14283	
34.976 1.3770	76.200 3.0000	20.625 0.8120	63500 14300	0.40	1.49	16500 3700	11300 2550	1.45	68900 15500	28138	28300X	

⁽¹⁾Based on 1×10^6 revolutions L_{10} life, for the ISO life-calculation method.

⁽²⁾Consult your Timken engineer for instructions on use or review the Timken Engineering Manual on timken.com/catalogs.

⁽³⁾Based on 90×10^6 revolutions L_{10} life, for The Timken Company life-calculation method. C_{90} and C_{a90} are radial and thrust values.

Bearing Dimensions											Geometry Factors			Bearing Weight
Width B	Width C	Eff. Ctr. a ⁽⁴⁾	Shaft			Housing			Cage		G ₁	G ₂	C _g	
			Max Shaft Fillet Radius R ⁽⁵⁾	Backing Shoulder Dia. d _a	Backing Shoulder Dia. d _b	Max Housing Fillet Radius r ⁽⁵⁾	Backing Shoulder Dia. D _a	Backing Shoulder Dia. D _b	A _a ⁽⁶⁾	A _b ⁽⁷⁾				
mm in.	mm in.	mm in.	mm in.	mm in.	mm in.	mm in.	mm in.	mm in.	mm in.	mm in.				kg lbs.
30.391 1.1965	23.812 0.9375	-10.9 -0.43	3.5 0.14	41.5 1.63	48.0 1.89	3.3 0.13	75.0 2.95	71.0 2.80	1.8 0.07	1.1 0.05	34.6	12.1	0.0744	0.75 1.66
30.391 1.1965	23.812 0.9375	-10.9 -0.43	3.5 0.14	41.5 1.63	48.0 1.89	3.3 0.13	76.0 2.99	72.0 2.83	1.8 0.07	1.1 0.05	34.6	12.1	0.0744	0.80 1.79
30.162 1.1875	23.812 0.9375	-8.1 -0.32	3.5 0.14	46.0 1.81	53.0 2.09	1.3 0.05	81.0 3.19	75.0 2.95	1.4 0.05	2.2 0.09	37.8	13.5	0.0873	0.90 1.98
30.162 1.1875	23.812 0.9375	-8.1 -0.32	0.8 0.03	46.0 1.81	47.0 1.85	3.3 0.13	81.0 3.19	73.0 2.87	1.4 0.05	2.2 0.09	37.8	13.5	0.0873	0.89 1.96
30.162 1.1875	23.812 0.9375	-8.1 -0.32	3.5 0.14	46.0 1.81	53.0 2.09	3.3 0.13	81.0 3.19	73.0 2.87	1.4 0.05	2.2 0.09	37.8	13.5	0.0873	0.89 1.96
30.886 1.2160	23.812 0.9375	-10.2 -0.40	3.5 0.14	43.0 1.69	49.5 1.95	3.3 0.13	81.0 3.19	75.0 2.95	2.2 0.09	0.7 0.03	39.5	12.5	0.0808	0.92 2.00
29.083 1.1450	22.225 0.8750	-9.7 -0.38	0.8 0.03	42.0 1.65	42.5 1.67	1.5 0.06	80.0 3.15	77.0 3.03	1.2 0.04	0.8 0.03	34.4	9.9	0.0731	0.88 1.92
40.386 1.5900	33.338 1.3125	-15.0 -0.59	3.5 0.14	49.0 1.93	55.0 2.17	3.3 0.13	85.0 3.35	77.0 3.03	2.2 0.09	0.6 0.03	52.9	14.3	0.0872	1.36 3.01
29.900 1.1772	22.225 0.8750	-9.1 -0.36	0.8 0.03	43.5 1.71	44.0 1.73	2.3 0.09	87.0 3.43	83.0 3.27	1.6 0.06	0.5 0.02	42.5	11.3	0.0805	1.08 2.38
16.520 0.6504	12.000 0.4724	-1.5 -0.06	1.5 0.06	40.5 1.59	42.5 1.67	1.5 0.06	64.0 2.52	61.0 2.40	1.1 0.04	1.6 0.06	17.5	11.5	0.0694	0.26 0.57
16.520 0.6504	11.908 0.4688	-1.5 -0.06	1.5 0.06	40.5 1.59	42.5 1.67	1.5 0.06	65.0 2.56	61.0 2.40	1.1 0.04	1.6 0.06	17.5	11.5	0.0694	0.26 0.58
19.583 0.7710	15.875 0.6250	-4.3 -0.17	1.3 0.05	41.5 1.63	43.5 1.71	3.3 0.13	63.0 2.48	59.0 2.32	1.0 0.04	1.5 0.06	18.0	13.3	0.0668	0.32 0.70
19.583 0.7710	15.875 0.6250	-4.3 -0.17	1.3 0.05	41.5 1.63	43.5 1.71	1.3 0.05	63.0 2.48	60.0 2.36	1.0 0.04	1.5 0.06	18.0	13.3	0.0668	0.32 0.72
19.583 0.7710	15.032 0.5918	-4.3 -0.17	1.3 0.05	41.5 1.63	43.5 1.71	1.5 0.06	65.0 2.56	62.0 2.44	1.0 0.04	1.5 0.06	18.0	13.3	0.0668	0.35 0.78
16.520 0.6504	14.288 0.5625	-1.5 -0.06	1.5 0.06	40.5 1.59	42.5 1.67	1.5 0.06	66.0 2.60	63.0 2.48	1.1 0.04	1.6 0.06	17.5	11.5	0.0694	0.32 0.70
19.583 0.7710	18.415 0.7250	-4.3 -0.17	1.3 0.05	41.5 1.63	43.5 1.71	2.3 0.09	65.0 2.56	60.0 2.36	1.0 0.04	1.5 0.06	18.0	13.3	0.0668	0.40 0.88
20.940 0.8244	15.494 0.6100	-4.8 -0.19	1.5 0.06	41.0 1.61	43.5 1.71	1.5 0.06	71.0 2.80	68.0 2.68	2.3 0.09	1.1 0.05	20.7	12.5	0.0709	0.43 0.95

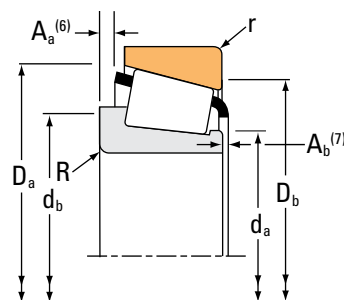
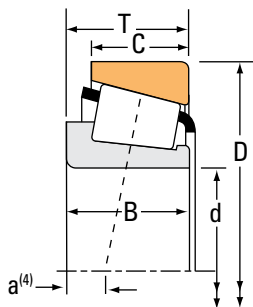
⁽⁴⁾Negative value indicates effective center inside cone (inner-ring) backface.
⁽⁵⁾These maximum fillet radii will be cleared by the bearing corners.
⁽⁶⁾Negative value indicates cage extends beyond cone (inner-ring) backface.
⁽⁷⁾Negative value indicates cage that does not extend beyond cone (inner-ring) front face.

Continued on next page.

TAPERED ROLLER BEARINGS

SINGLE-ROW • TYPE TS

TYPE TS



Bearing Dimensions			Load Ratings							Part Number			
Bore d	O.D. D	Width T	Dynamic ⁽¹⁾		Factors ⁽²⁾		Dynamic ⁽³⁾		Factors ⁽²⁾		Static C ₀	Inner	Outer
			C ₁	e	Y	C ₉₀	C _{a90}	K	N	N			
mm in.	mm in.	mm in.	N lbf			N lbf	N lbf				N lbf		
34.976 1.3770	80.000 3.1496	21.005 0.8270	63500 14300	0.40	1.49	16500 3700	11300 2550	1.45			68900 15500	28138	28315
34.987 1.3775	59.131 2.3280	15.875 0.6250	45500 10200	0.42	1.44	11800 2650	8400 1890	1.40			48700 11000	L68149	L68110
34.987 1.3775	59.975 2.3612	15.875 0.6250	45500 10200	0.42	1.44	11800 2650	8400 1890	1.40			48700 11000	L68149	L68111
34.987 1.3775	61.973 2.4399	16.700 0.6575	42500 9560	0.44	1.35	11000 2480	8380 1880	1.31			52400 11800	LM78349	LM78310A
34.987 1.3775	61.973 2.4399	16.701 0.6575	50400 11300	0.44	1.35	13100 2940	9940 2230	1.31			52400 11800	LM78349A	LM78310A
34.987 1.3775	61.973 2.4399	18.001 0.7087	42500 9560	0.44	1.35	11000 2480	8380 1880	1.31			52400 11800	LM78349	LM78310C
34.987 1.3775	61.973 2.4399	18.001 0.7087	50400 11300	0.44	1.35	13100 2940	9940 2230	1.31			52400 11800	LM78349A	LM78310C
34.987 1.3775	65.987 2.5979	20.638 0.8125	62400 14000	0.35	1.70	16200 3640	9770 2200	1.66			72800 16400	M38547	M38511
35.000 1.3780	70.000 2.7559	24.000 0.9949	66600 15000	0.55	1.10	17300 3880	16100 3630	1.07			84900 19100	JS-3549A	JS-3510
35.000 1.3780	72.000 2.8346	17.018 0.6700	50700 11400	0.44	1.35	13100 2960	10000 2250	1.31			57800 13000	19138X	19283
35.000 1.3780	72.000 2.8346	17.018 0.6700	50700 11400	0.44	1.35	13100 2960	10000 2250	1.31			57800 13000	19138X	19283X
35.000 1.3780	73.025 2.8750	26.988 1.0625	89400 20100	0.37	1.62	23200 5210	14700 3300	1.58			102000 22900	23691	23620
35.000 1.3780	73.025 2.8750	26.988 1.0625	89400 20100	0.37	1.62	23200 5210	14700 3300	1.58			102000 22900	23691	23621
35.000 1.3780	75.311 2.9650	19.845 0.7813	54600 12300	0.38	1.57	14200 3180	9260 2080	1.53			61700 13900	14139X	14274-S
35.000 1.3780	79.375 3.1250	23.812 0.9375	91100 20500	0.32	1.88	23600 5310	12900 2900	1.83			110000 24800	26883	26822
35.000 1.3780	80.000 3.1496	21.000 0.8268	94300 21200	0.27	2.20	24400 5490	11400 2570	2.14			83400 18700	339	332
35.000 1.3780	80.000 3.1496	23.813 0.9375	91100 20500	0.32	1.88	23600 5310	12900 2900	1.83			110000 24800	26883	26824

⁽¹⁾Based on 1 x 10⁶ revolutions L₁₀ life, for the ISO life-calculation method.

⁽²⁾Consult your Timken engineer for instructions on use or review the Timken Engineering Manual on timken.com/catalogs.

⁽³⁾Based on 90 x 10⁶ revolutions L₁₀ life, for The Timken Company life-calculation method. C₉₀ and C_{a90} are radial and thrust values.

Bearing Dimensions											Geometry Factors			Bearing Weight
Width B	Width C	Eff. Ctr. a ⁽⁴⁾	Shaft			Housing			Cage		G ₁	G ₂	C _g	
			Max Shaft Fillet Radius R ⁽⁵⁾	Backing Shoulder Dia. d _a	Backing Shoulder Dia. d _b	Max Housing Fillet Radius r ⁽⁵⁾	Backing Shoulder Dia. D _a	Backing Shoulder Dia. D _b	A _a ⁽⁶⁾	A _b ⁽⁷⁾				
mm in.	mm in.	mm in.	mm in.	mm in.	mm in.	mm in.	mm in.	mm in.	mm in.	mm in.				kg lbs.
20.940 0.8244	15.875 0.6250	-4.8 -0.19	1.5 0.06	41.0 1.61	43.5 1.71	1.5 0.06	73.0 2.87	69.0 2.72	2.3 0.09	1.1 0.05	20.7	12.5	0.0709	0.49 1.08
16.764 0.6600	11.938 0.4700	-2.5 -0.10	3.5 0.14	39.0 1.54	45.5 1.79	1.3 0.05	56.0 2.20	53.0 2.09	0.8 0.03	0.8 0.03	15.7	14.7	0.0657	0.17 0.37
16.764 0.6600	11.938 0.4700	-2.5 -0.10	3.5 0.14	39.0 1.54	45.5 1.79	1.3 0.05	56.0 2.20	53.0 2.09	0.8 0.03	0.8 0.03	15.7	14.7	0.0657	0.17 0.38
17.000 0.6693	13.600 0.5354	-2.5 -0.10	3.5 0.14	40.0 1.57	46.0 1.81	1.5 0.06	59.0 2.32	54.0 2.13	0.7 0.02	1.2 0.05	16.1	15.9	0.0678	0.19 0.44
17.000 0.6693	13.600 0.5354	-2.5 -0.10	1.5 0.06	39.5 1.56	42.0 1.65	1.5 0.06	59.0 2.32	54.0 2.13	0.7 0.02	1.2 0.05	16.1	15.9	0.0678	0.20 0.47
17.000 0.6693	15.000 0.5906	-2.5 -0.10	3.5 0.14	40.0 1.57	46.0 1.81	1.5 0.06	59.0 2.32	56.0 2.20	0.7 0.02	1.2 0.05	16.1	15.9	0.0678	0.20 0.46
17.000 0.6693	15.000 0.5906	-2.5 -0.10	1.5 0.06	39.5 1.56	42.0 1.65	1.5 0.06	59.0 2.32	56.0 2.20	0.7 0.02	1.2 0.05	16.1	15.9	0.0678	0.21 0.49
20.638 0.8125	16.670 0.6563	-5.6 -0.22	3.5 0.14	40.5 1.59	46.5 1.83	2.3 0.09	62.0 2.44	58.0 2.28	0.4 0.01	2.4 0.10	20.3	12.9	0.0680	0.30 0.66
23.500 0.9252	19.000 0.7480	-3.6 -0.14	2.0 0.08	42.0 1.65	47.0 1.85	1.5 0.06	66.5 2.62	60.0 2.36	1.5 0.06	1.6 0.07	20.7	11.0	0.0789	0.41 0.91
16.520 0.6504	14.288 0.5625	-1.5 -0.06	2.0 0.08	40.5 1.59	43.5 1.71	1.5 0.06	66.0 2.60	63.0 2.48	1.1 0.04	1.6 0.06	17.5	11.5	0.0694	0.32 0.70
16.520 0.6504	14.288 0.5625	-1.5 -0.06	2.0 0.08	40.5 1.59	43.5 1.71	2.0 0.08	66.0 2.60	62.0 2.44	1.1 0.04	1.6 0.06	17.5	11.5	0.0694	0.32 0.70
26.975 1.0620	22.225 0.8750	-8.1 -0.32	3.5 0.14	42.1 1.65	49.0 1.93	1.5 0.06	68.0 2.68	63.0 2.48	1.7 0.06	0.8 0.03	24.4	10.7	0.0734	0.52 1.14
26.975 1.0620	22.225 0.8750	-8.1 -0.32	3.5 0.14	42.1 1.65	49.0 1.93	0.8 0.03	68.0 2.68	63.0 2.48	1.7 0.06	0.8 0.03	24.4	10.7	0.0734	0.52 1.14
19.583 0.7710	15.875 0.6250	-4.3 -0.17	3.5 0.14	41.0 1.61	47.0 1.85	3.3 0.13	66.0 2.60	61.0 2.40	1.0 0.04	1.5 0.06	18.0	13.3	0.0668	0.40 0.89
25.400 1.0000	19.050 0.7500	-7.4 -0.29	0.8 0.03	42.0 1.65	42.5 1.67	0.8 0.03	74.0 2.91	71.0 2.80	1.4 0.05	1.3 0.05	32.8	13.3	0.0770	0.60 1.33
22.403 0.8820	17.826 0.7018	-6.4 -0.25	0.8 0.03	41.5 1.63	42.5 1.67	1.3 0.05	75.0 2.95	73.0 2.87	0.7 0.02	1.1 0.05	26.5	13.0	0.0676	0.52 1.17
25.400 1.0000	19.050 0.7500	-7.4 -0.29	0.8 0.03	42.0 1.65	42.5 1.67	1.3 0.05	74.0 2.91	70.0 2.76	1.4 0.05	1.3 0.05	32.8	13.3	0.0770	0.62 1.36

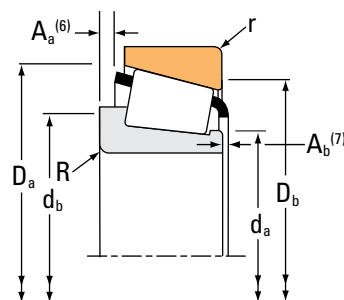
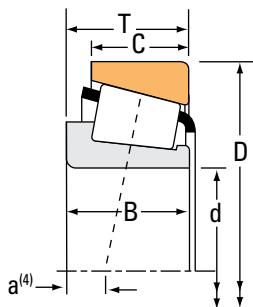
(4) Negative value indicates effective center inside cone (inner-ring) backface.
 (5) These maximum fillet radii will be cleared by the bearing corners.
 (6) Negative value indicates cage extends beyond cone (inner-ring) backface.
 (7) Negative value indicates cage that does not extend beyond cone (inner-ring) front face.

Continued on next page.

TAPERED ROLLER BEARINGS

SINGLE-ROW • TYPE TS

TYPE TS



Bearing Dimensions			Load Ratings							Part Number		
Bore d	O.D. D	Width T	Dynamic ⁽¹⁾		Factors ⁽²⁾		Dynamic ⁽³⁾		Factors ⁽²⁾	Static	Inner	Outer
			C ₁	e	Y	C ₉₀	C _{a90}	K	C ₀			
mm in.	mm in.	mm in.	N lbf			N lbf	N lbf		N lbf			
35.000 1.3780	80.167 3.1562	25.400 1.0000	91100 20500	0.32	1.88	23600 5310	12900 2900	1.83	110000 24800		26883	26820
35.000 1.3780	80.167 3.1562	29.370 1.1563	105000 23500	0.37	1.64	27100 6100	17000 3820	1.60	119000 26800		3480	3422
35.000 1.3780	82.550 3.2500	28.575 1.1250	116000 26000	0.26	2.28	30000 6740	13500 3040	2.22	124000 28000		421	412A
35.000 1.3780	88.500 3.4843	26.988 1.0625	116000 26000	0.26	2.28	30000 6740	13500 3040	2.22	124000 28000		421	414
35.306 1.3900	73.025 2.8750	22.225 0.8750	73200 16400	0.37	1.63	19000 4260	12000 2690	1.59	83800 18800		2880	2820
35.717 1.4062	72.233 2.8438	25.400 1.0000	76800 17300	0.55	1.10	19900 4480	18600 4180	1.07	94200 21200		HM88648	HM88610
36.487 1.4365	73.025 2.8750	23.812 0.9375	86900 19500	0.30	1.98	22500 5060	11700 2630	1.93	102000 23000		2794	2735X
36.487 1.4365	73.025 2.8750	23.812 0.9375	85100 19100	0.29	2.07	22100 4960	11000 2460	2.01	97400 21900		25880	25821
36.487 1.4365	73.025 2.8750	23.812 0.9375	86900 19500	0.30	1.98	22500 5060	11700 2630	1.93	102000 23000		2780	2735X
36.487 1.4365	73.025 2.8750	23.812 0.9375	85100 19100	0.29	2.07	22100 4960	11000 2460	2.01	97400 21900		25880	25820
36.487 1.4365	74.612 2.9375	23.812 0.9375	86900 19500	0.30	1.98	22500 5060	11700 2630	1.93	102000 23000		2780	2736
36.487 1.4365	76.200 3.0000	23.812 0.9375	86900 19500	0.30	1.98	22500 5060	11700 2630	1.93	102000 23000		2794	2720
36.487 1.4365	76.200 3.0000	23.812 0.9375	86900 19500	0.30	1.98	22500 5060	11700 2630	1.93	102000 23000		2780	2720
36.487 1.4365	76.200 3.0000	23.812 0.9375	86900 19500	0.30	1.98	22500 5060	11700 2630	1.93	102000 23000		2780	2729
36.487 1.4365	79.375 3.1250	23.812 0.9375	86900 19500	0.30	1.98	22500 5060	11700 2630	1.93	102000 23000		2780	2731
36.512 1.4375	68.262 2.6875	15.875 0.6250	50700 11400	0.44	1.35	13100 2960	10000 2250	1.31	57800 13000		19143	19268
36.512 1.4375	69.012 2.7170	19.050 0.7500	67200 15100	0.40	1.49	17400 3920	12000 2700	1.45	67900 15300		13682	13621

⁽¹⁾Based on 1 x 10⁶ revolutions L₁₀ life, for the ISO life-calculation method.

⁽²⁾Consult your Timken engineer for instructions on use or review the Timken Engineering Manual on timken.com/catalogs.

⁽³⁾Based on 90 x 10⁶ revolutions L₁₀ life, for The Timken Company life-calculation method. C₉₀ and C_{a90} are radial and thrust values.

Bearing Dimensions											Geometry Factors			Bearing Weight
Width B	Width C	Eff. Ctr. a ⁽⁴⁾	Shaft			Housing			Cage		G ₁	G ₂	C _g	
			Max Shaft Fillet Radius R ⁽⁵⁾	Backing Shoulder Dia. d _a	Backing Shoulder Dia. d _b	Max Housing Fillet Radius r ⁽⁵⁾	Backing Shoulder Dia. D _a	Backing Shoulder Dia. D _b	A _a ⁽⁶⁾	A _b ⁽⁷⁾				
mm in.	mm in.	mm in.	mm in.	mm in.	mm in.	mm in.	mm in.	mm in.	mm in.	mm in.				kg lbs.
25.400 1.0000	20.638 0.8125	-7.4 -0.29	0.8 0.03	42.0 1.65	42.5 1.67	3.3 0.13	74.0 2.91	69.0 2.72	1.4 0.05	1.3 0.05	32.8	13.3	0.0770	0.63 1.39
29.771 1.1721	23.812 0.9375	-8.6 -0.34	1.5 0.06	43.5 1.71	46.0 1.81	3.3 0.13	74.0 2.91	68.0 2.68	1.4 0.05	1.0 0.04	29.9	11.2	0.0781	0.72 1.59
29.083 1.1450	23.812 0.9375	-9.7 -0.38	0.8 0.03	42.0 1.65	42.5 1.67	1.5 0.06	77.7 3.06	73.9 2.91	1.2 0.04	0.8 0.03	34.4	9.9	0.0731	0.76 1.65
29.083 1.1450	22.225 0.8750	-9.7 -0.38	0.8 0.03	42.0 1.65	42.5 1.67	1.5 0.06	80.0 3.15	77.0 3.03	1.2 0.04	0.8 0.03	34.4	9.9	0.0731	0.88 1.92
23.812 0.9375	17.462 0.6875	-5.6 -0.22	3.5 0.14	41.5 1.63	48.0 1.89	3.3 0.13	68.0 2.68	63.0 2.48	0.9 0.03	0.2 0.01	23.1	12.4	0.0718	0.42 0.93
25.400 1.0000	19.842 0.7812	-4.6 -0.18	3.5 0.14	42.5 1.67	54.0 2.13	2.3 0.09	69.0 2.72	60.0 2.36	1.6 0.06	1.8 0.07	23.4	9.4	0.0822	0.47 1.05
25.654 1.0100	19.050 0.7500	-8.1 -0.32	3.5 0.14	42.5 1.67	49.0 1.93	0.8 0.03	69.0 2.72	66.0 2.60	1.4 0.05	0.9 0.04	28.7	12.2	0.0725	0.47 1.03
24.608 0.9688	19.050 0.7500	-8.1 -0.32	1.5 0.06	42.0 1.65	44.0 1.73	0.8 0.03	68.0 2.68	65.0 2.56	0.9 0.03	1.6 0.07	26.4	10.9	0.0695	0.46 1.00
25.654 1.0100	19.050 0.7500	-8.1 -0.32	1.5 0.06	42.5 1.67	44.5 1.75	0.8 0.03	69.0 2.72	66.0 2.60	1.4 0.05	0.9 0.04	28.7	12.2	0.0725	0.47 1.04
24.608 0.9688	19.050 0.7500	-8.1 -0.32	1.5 0.06	42.0 1.65	44.0 1.73	2.3 0.09	68.0 2.68	64.0 2.52	0.9 0.03	1.6 0.07	26.4	10.9	0.0695	0.45 0.99
25.654 1.0100	19.050 0.7500	-8.1 -0.32	1.5 0.06	42.5 1.67	44.5 1.75	0.8 0.03	70.0 2.76	67.0 2.64	1.4 0.05	0.9 0.04	28.7	12.2	0.0725	0.50 1.10
25.654 1.0100	19.050 0.7500	-8.1 -0.32	3.5 0.14	42.5 1.67	49.0 1.93	3.3 0.13	70.0 2.76	66.0 2.60	1.4 0.05	0.9 0.04	28.7	12.2	0.0725	0.52 1.13
25.654 1.0100	19.050 0.7500	-8.1 -0.32	1.5 0.06	42.5 1.67	44.5 1.75	3.3 0.13	70.0 2.76	66.0 2.60	1.4 0.05	0.9 0.04	28.7	12.2	0.0725	0.52 1.14
25.654 1.0100	19.050 0.7500	-8.1 -0.32	1.5 0.06	42.5 1.67	44.5 1.75	0.8 0.03	70.0 2.76	68.0 2.68	1.4 0.05	0.9 0.04	28.7	12.2	0.0725	0.53 1.16
25.654 1.0100	19.050 0.7500	-8.1 -0.32	1.5 0.06	42.5 1.67	44.5 1.75	3.3 0.13	72.0 2.83	67.0 2.64	1.4 0.05	0.9 0.04	28.7	12.2	0.0725	0.58 1.27
16.520 0.6504	11.908 0.4688	-1.5 -0.06	1.5 0.06	41.5 1.63	44.0 1.73	1.5 0.06	65.0 2.56	61.0 2.40	1.1 0.04	1.6 0.06	17.5	11.5	0.0694	0.25 0.55
19.050 0.7500	15.083 0.5938	-3.0 -0.12	3.5 0.14	41.5 1.63	48.0 1.89	2.3 0.09	65.0 2.56	61.0 2.40	0.9 0.03	0.7 0.03	20.7	12.2	0.0713	0.29 0.65

⁽⁴⁾Negative value indicates effective center inside cone (inner-ring) backface.

⁽⁵⁾These maximum fillet radii will be cleared by the bearing corners.

⁽⁶⁾Negative value indicates cage extends beyond cone (inner-ring) backface.

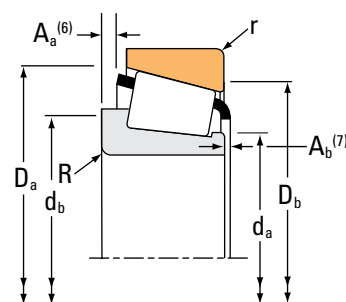
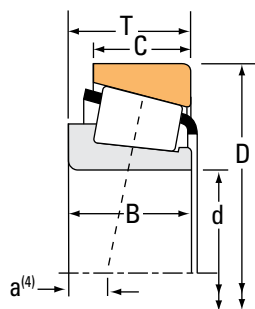
⁽⁷⁾Negative value indicates cage that does not extend beyond cone (inner-ring) front face.

Continued on next page.

TAPERED ROLLER BEARINGS

SINGLE-ROW • TYPE TS

TYPE TS



Bearing Dimensions			Load Ratings						Part Number				
Bore d	O.D. D	Width T	Dynamic ⁽¹⁾		Factors ⁽²⁾		Dynamic ⁽³⁾		Factors ⁽²⁾		Static C ₀	Inner	Outer
			C ₁	e	Y	C ₉₀	C _{a90}	K	N	N			
mm in.	mm in.	mm in.	N lbf			N lbf	N lbf		N lbf				
36.512 1.4375	72.000 2.8346	17.018 0.6700	50700 11400	0.44	1.35	13100 2960	10000 2250	1.31	57800 13000		19143	19283X	
36.512 1.4375	72.000 2.8346	17.018 0.6700	50700 11400	0.44	1.35	13100 2960	10000 2250	1.31	57800 13000		19143	19283	
36.512 1.4375	72.000 2.8346	19.000 0.7480	56600 12700	0.40	1.49	14700 3300	10100 2270	1.45	65800 14800		16143	16282	
36.512 1.4375	72.238 2.8440	20.638 0.8125	56600 12700	0.40	1.49	14700 3300	10100 2270	1.45	65800 14800		16143	16284	
36.512 1.4375	76.200 3.0000	29.370 1.1563	94700 21300	0.40	1.49	24600 5520	16900 3800	1.45	107000 24100		31597	31521	
36.512 1.4375	76.200 3.0000	29.370 1.1563	94700 21300	0.40	1.49	24600 5520	16900 3800	1.45	107000 24100		31597	31520	
36.512 1.4375	76.200 3.0000	29.370 1.1563	110000 24800	0.55	1.10	28600 6440	26800 6020	1.07	119000 26700		HM89449	HM89410	
36.512 1.4375	76.200 3.0000	29.370 1.1563	110000 24800	0.55	1.10	28600 6440	26800 6020	1.07	119000 26700		HM89449	HM89411	
36.512 1.4375	76.200 3.0000	29.370 1.1563	110000 24800	0.55	1.10	28600 6440	26800 6020	1.07	119000 26700		HM89448	HM89410	
36.512 1.4375	79.375 3.1250	29.370 1.1563	105000 23500	0.37	1.64	27100 6100	17000 3820	1.60	119000 26800		3479	3420	
36.512 1.4375	79.375 3.1250	29.370 1.1563	126000 28200	0.55	1.10	32600 7320	30400 6840	1.07	121000 27200		HM89249	HM89210	
36.512 1.4375	80.000 3.1496	23.812 0.9375	91100 20500	0.32	1.88	23600 5310	12900 2900	1.83	110000 24800		26877	26824	
36.512 1.4375	80.167 3.1562	25.400 1.0000	91100 20500	0.32	1.88	23600 5310	12900 2900	1.83	110000 24800		26877	26820	
36.512 1.4375	80.167 3.1562	29.370 1.1563	105000 23500	0.37	1.64	27100 6100	17000 3820	1.60	119000 26800		3479	3422	
36.512 1.4375	82.931 3.2650	23.812 0.9375	90500 20300	0.33	1.79	23500 5270	13500 3020	1.74	111000 24900		25570	25520	
36.512 1.4375	85.725 3.3750	30.162 1.1875	124000 27900	0.40	1.49	32200 7240	22200 4980	1.45	148000 33200		3878	3820	
36.512 1.4375	88.500 3.4843	25.400 1.0000	99800 22400	0.78	0.77	25900 5810	34600 7770	0.75	88600 19900		44143	44348	

⁽¹⁾Based on 1 x 10⁶ revolutions L₁₀ life, for the ISO life-calculation method.

⁽²⁾Consult your Timken engineer for instructions on use or review the Timken Engineering Manual on timken.com/catalogs.

⁽³⁾Based on 90 x 10⁶ revolutions L₁₀ life, for The Timken Company life-calculation method. C₉₀ and C_{a90} are radial and thrust values.

Bearing Dimensions											Geometry Factors			Bearing Weight
Width B	Width C	Eff. Ctr. a ⁽⁴⁾	Shaft			Housing			Cage		G ₁	G ₂	C _g	
			Max Shaft Fillet Radius R ⁽⁵⁾	Backing Shoulder Dia. d _a d _b		Max Housing Fillet Radius r ⁽⁵⁾	Backing Shoulder Dia. D _a D _b		A _a ⁽⁶⁾	A _b ⁽⁷⁾				
mm in.	mm in.	mm in.	mm in.	mm in.	mm in.	mm in.	mm in.	mm in.	mm in.	mm in.				kg lbs.
16.520 0.6504	14.288 0.5625	-1.5 -0.06	1.5 0.06	41.5 1.63	44.0 1.73	2.0 0.08	66.0 2.60	62.0 2.44	1.1 0.04	1.6 0.06	17.5	11.5	0.0694	0.31 0.68
16.520 0.6504	14.288 0.5625	-1.5 -0.06	1.5 0.06	41.5 1.63	44.0 1.73	1.5 0.06	66.0 2.60	63.0 2.48	1.1 0.04	1.6 0.06	17.5	11.5	0.0694	0.31 0.68
20.638 0.8125	14.237 0.5605	-4.1 -0.16	3.5 0.14	42.0 1.65	48.5 1.91	1.5 0.06	67.0 2.64	63.0 2.48	1.1 0.04	1.1 0.05	20.3	14.5	0.0707	0.34 0.76
20.638 0.8125	15.875 0.6250	-4.1 -0.16	3.5 0.14	42.0 1.65	48.5 1.91	1.3 0.05	67.0 2.64	63.0 2.48	1.1 0.04	1.1 0.05	20.3	14.5	0.0707	0.36 0.81
28.575 1.1250	23.812 0.9375	-7.6 -0.30	3.5 0.14	44.5 1.75	51.0 2.01	1.3 0.05	72.0 2.83	66.0 2.60	1.6 0.06	1.3 0.05	26.3	9.1	0.0773	0.60 1.33
28.575 1.1250	23.812 0.9375	-7.6 -0.30	3.5 0.14	44.5 1.75	51.0 2.01	3.3 0.13	72.0 2.83	64.0 2.52	1.6 0.06	1.3 0.05	26.3	9.1	0.0773	0.59 1.31
28.575 1.1250	23.020 0.9063	-5.6 -0.22	3.5 0.14	44.5 1.75	57.0 2.24	3.3 0.13	73.0 2.87	62.0 2.44	1.9 0.07	1.4 0.06	28.9	9.9	0.0883	0.62 1.37
28.575 1.1250	23.020 0.9063	-5.6 -0.22	3.5 0.14	44.5 1.75	57.0 2.24	0.8 0.03	73.0 2.87	65.0 2.56	1.9 0.07	1.4 0.06	28.9	9.9	0.0883	0.63 1.39
28.575 1.1250	23.020 0.9063	-5.6 -0.22	0.8 0.03	44.5 1.75	48.5 1.91	3.3 0.13	73.0 2.87	62.0 2.44	1.9 0.07	1.4 0.06	28.9	9.9	0.0883	0.62 1.38
29.771 1.1721	23.812 0.9375	-8.6 -0.34	0.8 0.03	44.5 1.75	45.5 1.79	3.3 0.13	74.0 2.91	67.0 2.64	1.4 0.05	1.0 0.04	29.9	11.2	0.0781	0.68 1.51
28.829 1.1350	22.664 0.8923	-5.8 -0.23	3.5 0.14	44.0 1.73	55.0 2.17	3.3 0.13	75.0 2.95	66.0 2.60	2.3 0.09	2.6 0.10	27.0	11.1	0.0861	0.70 1.53
25.400 1.0000	19.050 0.7500	-7.4 -0.29	0.8 0.03	43.0 1.69	44.0 1.73	1.3 0.05	74.0 2.91	70.0 2.76	1.4 0.05	1.3 0.05	32.8	13.3	0.0770	0.60 1.32
25.400 1.0000	20.638 0.8125	-7.4 -0.29	0.8 0.03	43.0 1.69	44.0 1.73	3.3 0.13	74.0 2.91	69.0 2.72	1.4 0.05	1.3 0.05	32.8	13.3	0.0770	0.61 1.36
29.771 1.1721	23.812 0.9375	-8.6 -0.34	0.8 0.03	44.5 1.75	45.5 1.79	3.3 0.13	74.0 2.91	68.0 2.68	1.4 0.05	1.0 0.04	29.9	11.2	0.0781	0.70 1.55
25.400 1.0000	19.050 0.7500	-6.4 -0.25	3.5 0.14	45.0 1.77	51.0 2.01	0.8 0.03	77.0 3.03	74.0 2.91	1.0 0.04	0.7 0.03	35.2	14.3	0.0801	0.66 1.45
30.162 1.1875	23.812 0.9375	-8.1 -0.32	0.8 0.03	47.0 1.85	48.0 1.89	3.3 0.13	81.0 3.19	73.0 2.87	1.4 0.05	2.2 0.09	37.8	13.5	0.0873	0.87 1.92
23.698 0.9330	17.462 0.6875	2.3 0.09	2.3 0.09	50.0 1.97	54.0 2.13	1.5 0.06	84.0 3.31	75.0 2.95	3.8 0.15	2.7 0.11	22.9	8.7	0.0899	0.73 1.60

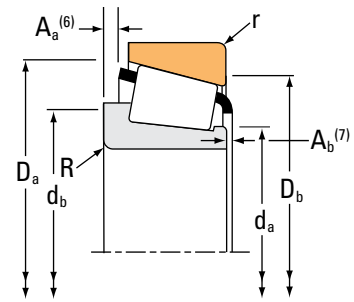
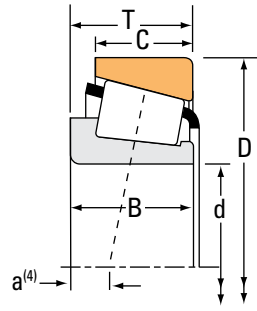
(4) Negative value indicates effective center inside cone (inner-ring) backface.
 (5) These maximum fillet radii will be cleared by the bearing corners.
 (6) Negative value indicates cage extends beyond cone (inner-ring) backface.
 (7) Negative value indicates cage that does not extend beyond cone (inner-ring) front face.

Continued on next page.

TAPERED ROLLER BEARINGS

SINGLE-ROW • TYPE TS

TYPE TS



Bearing Dimensions			Load Ratings							Part Number		
Bore d	O.D. D	Width T	Dynamic ⁽¹⁾		Factors ⁽²⁾		Dynamic ⁽³⁾		Factors ⁽²⁾	Static	Inner	Outer
			C ₁	e	Y	C ₉₀	C _{a90}	K	C ₀			
mm in.	mm in.	mm in.	N lbf			N lbf	N lbf			N lbf		
36.512 1.4375	93.662 3.6875	31.750 1.2500	129000 29100	0.40	1.49	33500 7540	23100 5190	1.45		158000 35500	46143	46368
38.000 1.4961	63.000 2.4803	17.000 0.6693	51000 11500	0.42	1.44	13200 2970	9410 2120	1.40		55000 12400	JL69349	JL69310
38.000 1.4961	63.000 2.4803	17.000 0.6693	51000 11500	0.42	1.44	13200 2970	9410 2120	1.40		55000 12400	JL69349A	JL69310
38.000 1.4961	63.000 2.4803	17.000 0.6693	51000 11500	0.42	1.44	13200 2970	9410 2120	1.40		55000 12400	JL69348	JL69310
38.000 1.4961	63.000 2.4803	17.000 0.6693	51000 11500	0.42	1.44	13200 2970	9410 2120	1.40		55000 12400	JL69349X	JL69310
38.000 1.4961	68.000 2.6772	16.020 0.6307	50700 11400	0.44	1.35	13100 2960	10000 2250	1.31		57800 13000	19149X	19267X
38.100 1.5000	63.500 2.5000	12.700 0.5000	27200 6100	0.35	1.73	7040 1580	4170 938	1.69		33000 7430	13889	13830
38.100 1.5000	65.088 2.5625	12.700 0.5000	27200 6100	0.35	1.73	7040 1580	4170 938	1.69		33000 7430	13889	13836
38.100 1.5000	65.088 2.5625	18.034 0.7100	48600 10900	0.33	1.80	12600 2830	7170 1610	1.76		60300 13600	LM29749	LM29710
38.100 1.5000	65.088 2.5625	18.034 0.7100	48600 10900	0.33	1.80	12600 2830	7170 1610	1.76		60300 13600	LM29748	LM29710
38.100 1.5000	65.088 2.5625	19.812 0.7800	48600 10900	0.33	1.80	12600 2830	7170 1610	1.76		60300 13600	LM29749	LM29711
38.100 1.5000	68.262 2.6875	15.875 0.6250	50700 11400	0.44	1.35	13100 2960	10000 2250	1.31		57800 13000	19150	19268
38.100 1.5000	68.262 2.6875	19.997 0.7873	50700 11400	0.44	1.35	13100 2960	10000 2250	1.31		57800 13000	19150	19269
38.100 1.5000	69.012 2.7170	19.050 0.7500	67200 15100	0.40	1.49	17400 3920	12000 2700	1.45		67900 15300	13685	13621
38.100 1.5000	69.012 2.7170	19.050 0.7500	67200 15100	0.40	1.49	17400 3920	12000 2700	1.45		67900 15300	13685A	13621
38.100 1.5000	69.012 2.7170	19.050 0.7500	67200 15100	0.40	1.49	17400 3920	12000 2700	1.45		67900 15300	13685	13620
38.100 1.5000	69.012 2.7170	19.050 0.7500	67200 15100	0.40	1.49	17400 3920	12000 2700	1.45		67900 15300	13687	13621

⁽¹⁾Based on 1 x 10⁶ revolutions L₁₀ life, for the ISO life-calculation method.

⁽²⁾Consult your Timken engineer for instructions on use or review the Timken Engineering Manual on timken.com/catalogs.

⁽³⁾Based on 90 x 10⁶ revolutions L₁₀ life, for The Timken Company life-calculation method. C₉₀ and C_{a90} are radial and thrust values.

Bearing Dimensions											Geometry Factors			Bearing Weight
Width B	Width C	Eff. Ctr. a ⁽⁴⁾	Shaft			Housing			Cage		G ₁	G ₂	C _g	
			Max Shaft Fillet Radius R ⁽⁵⁾	Backing Shoulder Dia. d _a	Shoulder Dia. d _b	Max Housing Fillet Radius r ⁽⁵⁾	Backing Shoulder Dia. D _a	Shoulder Dia. D _b	A _a ⁽⁶⁾	A _b ⁽⁷⁾				
mm in.	mm in.	mm in.	mm in.	mm in.	mm in.	mm in.	mm in.	mm in.	mm in.	mm in.				kg lbs.
31.750 1.2500	26.195 1.0313	-7.9 -0.31	1.5 0.06	48.0 1.89	50.0 1.97	3.3 0.13	87.0 3.43	79.0 3.11	2.1 0.08	1.1 0.05	44.4	13.6	0.0920	1.15 2.53
17.000 0.6693	13.500 0.5315	-2.3 -0.09	0.0 0.00	42.5 1.67	46.5 1.83	1.3 0.05	60.0 2.36	56.0 2.20	0.5 0.02	1.4 0.06	18.4	13.6	0.0692	0.20 0.45
17.000 0.6693	13.500 0.5315	-2.3 -0.09	1.3 0.05	42.5 1.67	44.5 1.75	1.3 0.05	60.0 2.36	56.0 2.20	0.5 0.02	1.3 0.05	18.4	13.6	0.0692	0.20 0.45
17.000 0.6693	13.500 0.5315	-2.3 -0.09	3.3 0.13	42.5 1.67	46.5 1.83	1.3 0.05	60.0 2.36	56.0 2.20	0.5 0.02	1.4 0.06	18.4	13.6	0.0692	0.20 0.45
17.000 0.6693	13.500 0.5315	-2.3 -0.09	2.3 0.09	43.0 1.69	47.0 1.85	1.3 0.05	60.0 2.36	56.0 2.20	0.5 0.02	1.3 0.05	18.4	13.6	0.0692	0.20 0.45
16.520 0.6504	12.000 0.4724	-1.5 -0.06	2.0 0.08	43.0 1.69	46.0 1.81	1.5 0.06	64.0 2.52	61.0 2.40	1.1 0.04	1.6 0.06	17.5	11.5	0.0694	0.24 0.52
11.908 0.4688	9.525 0.3750	-0.8 -0.03	1.5 0.06	42.5 1.67	45.0 1.77	0.8 0.03	60.0 2.36	59.0 2.32	0.2 0.00	1.4 0.06	14.8	23.3	0.0601	0.14 0.33
11.908 0.4688	9.525 0.3750	-0.8 -0.03	1.5 0.06	42.5 1.67	45.0 1.77	0.8 0.03	61.0 2.40	59.0 2.32	0.2 0.00	1.4 0.06	14.8	23.3	0.0601	0.16 0.35
18.288 0.7200	13.970 0.5500	-4.1 -0.16	2.3 0.09	42.5 1.67	46.5 1.83	1.3 0.05	62.0 2.44	58.9 2.32	0.7 0.02	1.1 0.05	20.4	15.0	0.0666	0.24 0.51
18.288 0.7200	13.970 0.5500	-4.1 -0.16	3.5 0.14	42.5 1.67	49.0 1.93	1.3 0.05	62.0 2.44	58.9 2.32	0.7 0.02	1.1 0.05	20.4	15.0	0.0666	0.23 0.50
18.288 0.7200	15.748 0.6200	-4.1 -0.16	2.3 0.09	42.5 1.67	46.5 1.83	1.3 0.05	62.0 2.44	58.0 2.28	0.7 0.02	1.1 0.05	20.4	15.0	0.0666	0.25 0.55
16.520 0.6504	11.908 0.4688	-1.5 -0.06	1.5 0.06	43.0 1.69	45.0 1.77	1.5 0.06	65.0 2.56	61.0 2.40	1.1 0.04	1.6 0.06	17.5	11.5	0.0694	0.24 0.53
16.520 0.6504	16.030 0.6311	-1.5 -0.06	1.5 0.06	43.0 1.69	45.0 1.77	1.5 0.06	65.0 2.56	60.0 2.36	1.1 0.04	1.6 0.06	17.5	11.5	0.0694	0.28 0.61
19.050 0.7500	15.083 0.5938	-3.0 -0.12	3.5 0.14	43.0 1.69	49.5 1.95	2.3 0.09	65.0 2.56	61.0 2.40	0.9 0.03	0.7 0.03	20.7	12.2	0.0713	0.28 0.62
19.050 0.7500	15.083 0.5938	-3.0 -0.12	0.8 0.03	43.0 1.69	44.0 1.73	2.3 0.09	65.0 2.56	61.0 2.40	0.9 0.03	0.7 0.03	20.7	12.2	0.0713	0.29 0.63
19.050 0.7500	15.083 0.5938	-3.0 -0.12	3.5 0.14	43.0 1.69	49.5 1.95	0.8 0.03	65.0 2.56	62.0 2.44	0.9 0.03	0.7 0.03	20.7	12.2	0.0713	0.28 0.63
19.050 0.7500	15.083 0.5938	-3.0 -0.12	2.0 0.08	43.0 1.69	46.5 1.83	2.3 0.09	65.0 2.56	61.0 2.40	0.9 0.03	0.7 0.03	20.7	12.2	0.0713	0.28 0.63

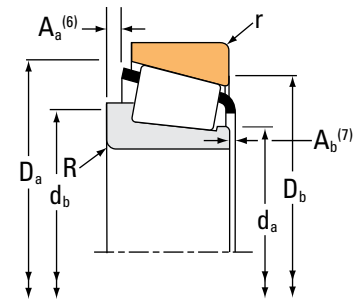
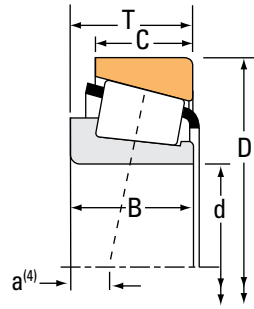
(4) Negative value indicates effective center inside cone (inner-ring) backface.
 (5) These maximum fillet radii will be cleared by the bearing corners.
 (6) Negative value indicates cage extends beyond cone (inner-ring) backface.
 (7) Negative value indicates cage that does not extend beyond cone (inner-ring) front face.

Continued on next page.

TAPERED ROLLER BEARINGS

SINGLE-ROW • TYPE TS

TYPE TS



Bearing Dimensions			Load Ratings							Part Number			
Bore d	O.D. D	Width T	Dynamic ⁽¹⁾		Factors ⁽²⁾		Dynamic ⁽³⁾		Factors ⁽²⁾		Static C ₀	Inner	Outer
			C ₁	e	Y	C ₉₀	C _{a90}	K	N	N			
mm in.	mm in.	mm in.	N lbf			N lbf	N lbf		N lbf				
38.100 1.5000	69.012 2.7170	19.050 0.7500	67200 15100	0.40	1.49	17400 3920	12000 2700	1.45	67900 15300		13687	13620	
38.100 1.5000	69.012 2.7170	19.050 0.7500	67200 15100	0.40	1.49	17400 3920	12000 2700	1.45	67900 15300		13685A	13620	
38.100 1.5000	69.012 2.7170	26.195 1.0313	67200 15100	0.40	1.49	17400 3920	12000 2700	1.45	67900 15300		13686	13621	
38.100 1.5000	69.012 2.7170	26.195 1.0313	67200 15100	0.40	1.49	17400 3920	12000 2700	1.45	67900 15300		13686	13620	
38.100 1.5000	69.969 2.7547	21.996 0.8660	67200 15100	0.40	1.49	17400 3920	12000 2700	1.45	67900 15300		13685	13624	
38.100 1.5000	69.969 2.7547	21.996 0.8660	67200 15100	0.40	1.49	17400 3920	12000 2700	1.45	67900 15300		13687	13624	
38.100 1.5000	71.438 2.8125	15.875 0.6250	50700 11400	0.44	1.35	13100 2960	10000 2250	1.31	57800 13000		19150	19281	
38.100 1.5000	72.000 2.8346	17.018 0.6700	50700 11400	0.44	1.35	13100 2960	10000 2250	1.31	57800 13000		19150	19283	
38.100 1.5000	72.000 2.8346	19.000 0.7480	56600 12700	0.40	1.49	14700 3300	10100 2270	1.45	65800 14800		16150	16282	
38.100 1.5000	72.238 2.8440	20.638 0.8125	56600 12700	0.40	1.49	14700 3300	10100 2270	1.45	65800 14800		16150	16284	
38.100 1.5000	72.238 2.8440	23.812 0.9375	56600 12700	0.40	1.49	14700 3300	10100 2270	1.45	65800 14800		16150	16283	
38.100 1.5000	73.025 2.8750	23.812 0.9375	86900 19500	0.30	1.98	22500 5060	11700 2630	1.93	102000 23000		2788	2735X	
38.100 1.5000	73.025 2.8750	23.812 0.9375	86900 19500	0.30	1.98	22500 5060	11700 2630	1.93	102000 23000		2788A	2735X	
38.100 1.5000	73.025 2.8750	23.812 0.9375	86900 19500	0.30	1.98	22500 5060	11700 2630	1.93	102000 23000		2776	2735X	
38.100 1.5000	74.612 2.9375	23.812 0.9375	86900 19500	0.30	1.98	22500 5060	11700 2630	1.93	102000 23000		2788A	2736	
38.100 1.5000	76.200 3.0000	20.625 0.8120	75200 16900	0.40	1.49	19500 4390	13400 3020	1.45	68900 15500		28150	28300X	
38.100 1.5000	76.200 3.0000	20.638 0.8125	63500 14300	0.40	1.49	16500 3700	11300 2550	1.45	68900 15500		28151	28300	

⁽¹⁾Based on 1 x 10⁶ revolutions L₁₀ life, for the ISO life-calculation method.

⁽²⁾Consult your Timken engineer for instructions on use or review the Timken Engineering Manual on timken.com/catalogs.

⁽³⁾Based on 90 x 10⁶ revolutions L₁₀ life, for The Timken Company life-calculation method. C₉₀ and C_{a90} are radial and thrust values.

Bearing Dimensions											Geometry Factors			Bearing Weight
Width B	Width C	Eff. Ctr. a ⁽⁴⁾	Shaft			Housing			Cage		G ₁	G ₂	C _g	
			Max Shaft Fillet Radius R ⁽⁵⁾	Backing Shoulder Dia. d _a	Backing Shoulder Dia. d _b	Max Housing Fillet Radius r ⁽⁵⁾	Backing Shoulder Dia. D _a	Backing Shoulder Dia. D _b	A _a ⁽⁶⁾	A _b ⁽⁷⁾				
mm in.	mm in.	mm in.	mm in.	mm in.	mm in.	mm in.	mm in.	mm in.	mm in.	mm in.				kg lbs.
19.050 0.7500	15.083 0.5938	-3.0 -0.12	2.0 0.08	43.0 1.69	46.5 1.83	0.8 0.03	65.0 2.56	62.0 2.44	0.9 0.03	0.7 0.03	20.7	12.2	0.0713	0.28 0.64
19.050 0.7500	15.083 0.5938	-3.0 -0.12	0.8 0.03	43.0 1.69	44.0 1.73	0.8 0.03	65.0 2.56	62.0 2.44	0.9 0.03	0.7 0.03	20.7	12.2	0.0713	0.29 0.64
26.195 1.0313	15.083 0.5938	-10.2 -0.40	1.5 0.06	43.0 1.69	45.5 1.79	2.3 0.09	65.0 2.56	61.0 2.40	8.0 0.31	0.7 0.03	20.7	12.2	0.0713	0.35 0.76
26.195 1.0313	15.083 0.5938	-10.2 -0.40	1.5 0.06	43.0 1.69	45.5 1.79	0.8 0.03	65.0 2.56	62.0 2.44	8.0 0.31	0.7 0.03	20.7	12.2	0.0713	0.35 0.77
19.050 0.7500	18.029 0.7098	-3.0 -0.12	3.5 0.14	43.0 1.69	49.5 1.95	1.5 0.06	65.0 2.56	61.0 2.40	0.9 0.03	0.7 0.03	20.7	12.2	0.0713	0.33 0.73
19.050 0.7500	18.029 0.7098	-3.0 -0.12	2.0 0.08	43.0 1.69	46.5 1.83	1.5 0.06	65.0 2.56	61.0 2.40	0.9 0.03	0.7 0.03	20.7	12.2	0.0713	0.33 0.73
16.520 0.6504	11.908 0.4688	-1.5 -0.06	1.5 0.06	43.0 1.69	45.0 1.77	1.0 0.04	66.0 2.60	63.0 2.48	1.1 0.04	1.6 0.06	17.5	11.5	0.0694	0.28 0.60
16.520 0.6504	14.288 0.5625	-1.5 -0.06	1.5 0.06	43.0 1.69	45.0 1.77	1.5 0.06	66.0 2.60	63.0 2.48	1.1 0.04	1.6 0.06	17.5	11.5	0.0694	0.30 0.66
20.638 0.8125	14.237 0.5605	-4.1 -0.16	3.5 0.14	43.0 1.69	49.5 1.95	1.5 0.06	67.0 2.64	63.0 2.48	1.1 0.04	1.1 0.05	20.3	14.5	0.0707	0.33 0.73
20.638 0.8125	15.875 0.6250	-4.1 -0.16	3.5 0.14	43.0 1.69	49.5 1.95	1.3 0.05	67.0 2.64	63.0 2.48	1.1 0.04	1.1 0.05	20.3	14.5	0.0707	0.35 0.78
20.638 0.8125	19.050 0.7500	-4.1 -0.16	3.5 0.14	43.0 1.69	49.5 1.95	2.3 0.09	67.0 2.64	61.0 2.40	1.1 0.04	1.1 0.05	20.3	14.5	0.0707	0.39 0.86
25.654 1.0100	19.050 0.7500	-8.1 -0.32	3.5 0.14	43.5 1.71	50.0 1.97	0.8 0.03	69.0 2.72	66.0 2.60	1.4 0.05	0.9 0.04	28.7	12.2	0.0725	0.45 0.99
25.654 1.0100	19.050 0.7500	-8.1 -0.32	1.5 0.06	43.5 1.71	46.0 1.81	0.8 0.03	69.0 2.72	66.0 2.60	1.4 0.05	0.9 0.04	28.7	12.2	0.0725	0.45 1.00
25.654 1.0100	19.050 0.7500	-8.1 -0.32	4.3 0.17	43.5 1.71	52.0 2.05	0.8 0.03	69.0 2.72	66.0 2.60	1.4 0.05	0.9 0.04	28.7	12.2	0.0725	0.45 0.99
25.654 1.0100	19.050 0.7500	-8.1 -0.32	1.5 0.06	43.5 1.71	46.0 1.81	0.8 0.03	70.0 2.76	67.0 2.64	1.4 0.05	0.9 0.04	28.7	12.2	0.0725	0.48 1.06
20.940 0.8244	15.494 0.6100	-4.8 -0.19	1.5 0.06	43.5 1.71	45.5 1.79	1.5 0.06	71.0 2.80	68.0 2.68	2.3 0.09	1.1 0.05	20.7	12.5	0.0709	0.40 0.89
20.940 0.8244	15.507 0.6105	-4.8 -0.19	3.5 0.14	43.5 1.71	50.0 1.97	1.3 0.05	71.0 2.80	68.0 2.68	2.3 0.09	1.1 0.05	20.7	12.5	0.0709	0.39 0.87

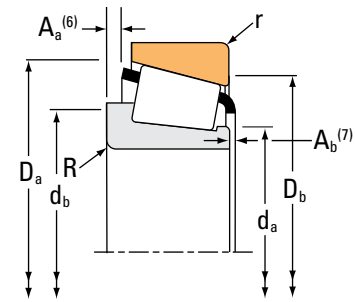
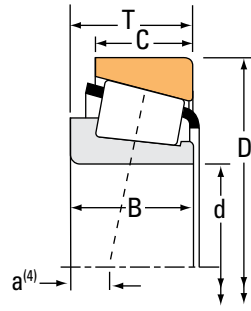
⁽⁴⁾Negative value indicates effective center inside cone (inner-ring) backface.
⁽⁵⁾These maximum fillet radii will be cleared by the bearing corners.
⁽⁶⁾Negative value indicates cage extends beyond cone (inner-ring) backface.
⁽⁷⁾Negative value indicates cage that does not extend beyond cone (inner-ring) front face.

Continued on next page.

TAPERED ROLLER BEARINGS

SINGLE-ROW • TYPE TS

TYPE TS



Bearing Dimensions			Load Ratings						Part Number			
Bore d	O.D. D	Width T	Dynamic ⁽¹⁾		Factors ⁽²⁾		Dynamic ⁽³⁾		Static		Inner	Outer
			C ₁	e	Y	C ₉₀	C _{a90}	K	C ₀			
mm in.	mm in.	mm in.	N lbf			N lbf	N lbf		N lbf			
38.100 1.5000	76.200 3.0000	20.638 0.8125	75200 16900	0.40	1.49	19500 4390	13400 3020	1.45	68900 15500		28150	28300
38.100 1.5000	76.200 3.0000	23.812 0.9375	86900 19500	0.30	1.98	22500 5060	11700 2630	1.93	102000 23000		2788	2720
38.100 1.5000	76.200 3.0000	23.812 0.9375	86900 19500	0.30	1.98	22500 5060	11700 2630	1.93	102000 23000		2788	2729X
38.100 1.5000	76.200 3.0000	23.812 0.9375	86900 19500	0.30	1.98	22500 5060	11700 2630	1.93	102000 23000		2776	2720
38.100 1.5000	76.200 3.0000	23.812 0.9375	86900 19500	0.30	1.98	22500 5060	11700 2630	1.93	102000 23000		2788A	2720
38.100 1.5000	76.200 3.0000	23.812 0.9375	86900 19500	0.30	1.98	22500 5060	11700 2630	1.93	102000 23000		2788	2729
38.100 1.5000	76.200 3.0000	23.812 0.9375	86900 19500	0.30	1.98	22500 5060	11700 2630	1.93	102000 23000		2777	2720
38.100 1.5000	76.200 3.0000	23.812 0.9375	86900 19500	0.30	1.98	22500 5060	11700 2630	1.93	102000 23000		2788A	2729
38.100 1.5000	76.200 3.0000	25.400 1.0000	91100 20500	0.32	1.88	23600 5310	12900 2900	1.83	110000 24800		26878	26823
38.100 1.5000	79.375 3.1250	23.812 0.9375	91100 20500	0.32	1.88	23600 5310	12900 2900	1.83	110000 24800		26878	26822
38.100 1.5000	79.375 3.1250	25.400 1.0000	86900 19500	0.30	1.98	22500 5060	11700 2630	1.93	102000 23000		2788	2734
38.100 1.5000	79.375 3.1250	25.400 1.0000	86900 19500	0.30	1.98	22500 5060	11700 2630	1.93	102000 23000		2776	2734
38.100 1.5000	79.375 3.1250	29.370 1.1563	105000 23500	0.37	1.64	27100 6100	17000 3820	1.60	119000 26800		3490	3420
38.100 1.5000	79.975 3.1486	29.370 1.1563	115000 25800	0.27	2.20	29800 6700	13900 3130	2.14	129000 29100		3387	3325
38.100 1.5000	80.000 3.1496	21.006 0.8270	75200 16900	0.40	1.49	19500 4390	13400 3020	1.45	68900 15500		28150	28315A
38.100 1.5000	80.000 3.1496	23.812 0.9375	91100 20500	0.32	1.88	23600 5310	12900 2900	1.83	110000 24800		26878	26824
38.100 1.5000	80.035 3.1510	24.608 0.9688	78000 17500	0.56	1.07	20200 4550	19400 4370	1.04	91100 20500		27880	27820

⁽¹⁾Based on 1 x 10⁶ revolutions L₁₀ life, for the ISO life-calculation method.

⁽²⁾Consult your Timken engineer for instructions on use or review the Timken Engineering Manual on timken.com/catalogs.

⁽³⁾Based on 90 x 10⁶ revolutions L₁₀ life, for The Timken Company life-calculation method. C₉₀ and C_{a90} are radial and thrust values.

Bearing Dimensions											Geometry Factors			Bearing Weight
Width B	Width C	Eff. Ctr. a ⁽⁴⁾	Shaft			Housing			Cage		G ₁	G ₂	C _g	
			Max Shaft Fillet Radius R ⁽⁵⁾	Backing Shoulder Dia. d _a	Shoulder Dia. d _b	Max Housing Fillet Radius r ⁽⁵⁾	Backing Shoulder Dia. D _a	Shoulder Dia. D _b	A _a ⁽⁶⁾	A _b ⁽⁷⁾				
mm in.	mm in.	mm in.	mm in.	mm in.	mm in.	mm in.	mm in.	mm in.	mm in.	mm in.				kg lbs.
20.940 0.8244	15.507 0.6105	-4.8 -0.19	1.5 0.06	43.5 1.71	45.5 1.79	1.3 0.05	71.0 2.80	68.0 2.68	2.3 0.09	1.1 0.05	20.7	12.5	0.0709	0.40 0.88
25.654 1.0100	19.050 0.7500	-8.1 -0.32	3.5 0.14	43.5 1.71	50.0 1.97	3.3 0.13	70.0 2.76	66.0 2.60	1.4 0.05	0.9 0.04	28.7	12.2	0.0725	0.50 1.09
25.654 1.0100	19.050 0.7500	-8.1 -0.32	3.5 0.14	43.5 1.71	50.0 1.97	1.5 0.06	70.0 2.76	67.0 2.64	1.4 0.05	0.9 0.04	28.7	12.2	0.0725	0.51 1.11
25.654 1.0100	19.050 0.7500	-8.1 -0.32	4.3 0.17	43.5 1.71	52.0 2.05	3.3 0.13	70.0 2.76	66.0 2.60	1.4 0.05	0.9 0.04	28.7	12.2	0.0725	0.50 1.09
25.654 1.0100	19.050 0.7500	-8.1 -0.32	1.5 0.06	43.5 1.71	46.0 1.81	3.3 0.13	70.0 2.76	66.0 2.60	1.4 0.05	0.9 0.04	28.7	12.2	0.0725	0.50 1.10
25.654 1.0100	19.050 0.7500	-8.1 -0.32	3.5 0.14	43.5 1.71	50.0 1.97	0.8 0.03	70.0 2.76	68.0 2.68	1.4 0.05	0.9 0.04	28.7	12.2	0.0725	0.51 1.12
25.654 1.0100	19.050 0.7500	-8.1 -0.32	5.5 0.22	43.5 1.71	54.0 2.13	3.3 0.13	70.0 2.76	66.0 2.60	1.4 0.05	0.9 0.04	28.7	12.2	0.0725	0.49 1.07
25.654 1.0100	19.050 0.7500	-8.1 -0.32	1.5 0.06	43.5 1.71	46.0 1.81	0.8 0.03	70.0 2.76	68.0 2.68	1.4 0.05	0.9 0.04	28.7	12.2	0.0725	0.51 1.12
25.400 1.0000	20.638 0.8125	-7.4 -0.29	0.8 0.03	44.5 1.75	45.0 1.77	1.5 0.06	73.0 2.87	69.0 2.72	1.4 0.05	1.3 0.05	32.8	13.3	0.0770	0.52 1.16
25.400 1.0000	19.050 0.7500	-7.4 -0.29	0.8 0.03	44.5 1.75	45.0 1.77	0.8 0.03	74.0 2.91	71.0 2.80	1.4 0.05	1.3 0.05	32.8	13.3	0.0770	0.56 1.26
25.654 1.0100	20.638 0.8125	-8.1 -0.32	3.5 0.14	43.5 1.71	50.0 1.97	3.3 0.13	72.0 2.83	67.0 2.64	1.4 0.05	0.9 0.04	28.7	12.2	0.0725	0.58 1.28
25.654 1.0100	20.638 0.8125	-8.1 -0.32	4.3 0.17	43.5 1.71	52.0 2.05	3.3 0.13	72.0 2.83	67.0 2.64	1.4 0.05	0.9 0.04	28.7	12.2	0.0725	0.58 1.27
29.771 1.1721	23.812 0.9375	-8.6 -0.34	3.5 0.14	45.5 1.80	52.0 2.05	3.3 0.13	74.0 2.91	67.0 2.64	1.4 0.05	1.0 0.04	29.9	11.2	0.0781	0.65 1.44
30.391 1.1965	23.812 0.9375	-10.9 -0.43	0.8 0.03	44.5 1.75	45.0 1.77	3.3 0.13	74.8 2.94	70.0 2.76	1.8 0.07	1.1 0.05	34.6	12.1	0.0744	0.67 1.48
20.940 0.8244	15.875 0.6250	-4.8 -0.19	1.5 0.06	43.5 1.71	45.5 1.79	2.0 0.08	73.0 2.87	69.0 2.72	2.3 0.09	1.1 0.05	20.7	12.5	0.0709	0.46 1.01
25.400 1.0000	19.050 0.7500	-7.4 -0.29	0.8 0.03	44.5 1.75	45.0 1.77	1.3 0.05	74.0 2.91	70.0 2.76	1.4 0.05	1.3 0.05	32.8	13.3	0.0770	0.58 1.28
23.698 0.9330	18.512 0.7288	-2.5 -0.10	0.8 0.03	47.0 1.85	48.0 1.89	1.5 0.06	75.0 2.95	68.0 2.68	3.2 0.12	1.5 0.06	24.6	12.6	0.0839	0.56 1.23

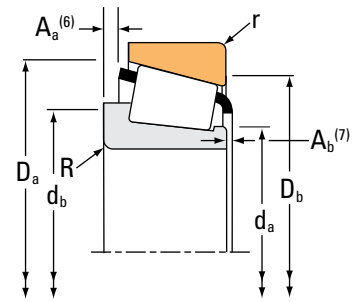
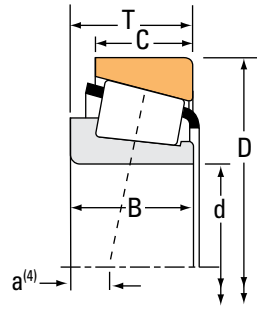
(4) Negative value indicates effective center inside cone (inner-ring) backface.
 (5) These maximum fillet radii will be cleared by the bearing corners.
 (6) Negative value indicates cage extends beyond cone (inner-ring) backface.
 (7) Negative value indicates cage that does not extend beyond cone (inner-ring) front face.

Continued on next page.

TAPERED ROLLER BEARINGS

SINGLE-ROW • TYPE TS

TYPE TS



Bearing Dimensions			Load Ratings							Part Number		
Bore d	O.D. D	Width T	Dynamic ⁽¹⁾		Factors ⁽²⁾		Dynamic ⁽³⁾		Factors ⁽²⁾	Static	Inner	Outer
			C ₁	e	Y	C ₉₀	C _{a90}	K	C ₀			
mm in.	mm in.	mm in.	N lbf			N lbf	N lbf			N lbf		
38.100 1.5000	80.035 3.1510	24.608 0.9688	78000 17500	0.56	1.07	20200 4550	19400 4370	1.04	91100 20500	27881	27820	
38.100 1.5000	80.035 3.1510	29.370 1.1563	115000 25800	0.27	2.20	29800 6700	13900 3130	2.14	129000 29100	3387	3339	
38.100 1.5000	80.167 3.1562	25.400 1.0000	91100 20500	0.32	1.88	23600 5310	12900 2900	1.83	110000 24800	26878	26820	
38.100 1.5000	80.167 3.1562	25.400 1.0000	91100 20500	0.32	1.88	23600 5310	12900 2900	1.83	110000 24800	26878	26830	
38.100 1.5000	80.167 3.1562	26.988 1.0625	79500 17900	0.27	2.20	20600 4640	9640 2170	2.14	83400 18700	347	3320	
38.100 1.5000	80.167 3.1562	29.370 1.1563	115000 25800	0.27	2.20	29800 6700	13900 3130	2.14	129000 29100	3381	3331	
38.100 1.5000	80.167 3.1562	29.370 1.1563	115000 25800	0.27	2.20	29800 6700	13900 3130	2.14	129000 29100	3381	3320	
38.100 1.5000	80.167 3.1562	29.370 1.1563	115000 25800	0.27	2.20	29800 6700	13900 3130	2.14	129000 29100	3387	3320	
38.100 1.5000	81.755 3.2187	29.370 1.1563	115000 25800	0.27	2.20	29800 6700	13900 3130	2.14	129000 29100	3381	3329	
38.100 1.5000	81.755 3.2187	29.370 1.1563	115000 25800	0.27	2.20	29800 6700	13900 3130	2.14	129000 29100	3387	3329	
38.100 1.5000	82.550 3.2500	29.370 1.1563	103000 23100	0.55	1.10	26600 5980	24900 5590	1.07	130000 29300	HM801346	HM801310	
38.100 1.5000	82.550 3.2500	29.370 1.1563	103000 23100	0.55	1.10	26600 5980	24900 5590	1.07	130000 29300	HM801346X	HM801310	
38.100 1.5000	82.550 3.2500	29.370 1.1563	103000 23100	0.55	1.10	26600 5980	24900 5590	1.07	130000 29300	HM801346	HM801311	
38.100 1.5000	82.931 3.2650	23.812 0.9375	90500 20300	0.33	1.79	23500 5270	13500 3020	1.74	111000 24900	25572	25520	
38.100 1.5000	85.000 3.3465	23.812 0.9375	90500 20300	0.33	1.79	23500 5270	13500 3020	1.74	111000 24900	25572	25526	
38.100 1.5000	85.725 3.3750	30.162 1.1875	124000 27900	0.40	1.49	32200 7240	22200 4980	1.45	148000 33200	3875	3820	
38.100 1.5000	85.725 3.3750	30.162 1.1875	124000 27900	0.40	1.49	32200 7240	22200 4980	1.45	148000 33200	3876	3821	

⁽¹⁾Based on 1 x 10⁶ revolutions L₁₀ life, for the ISO life-calculation method.

⁽²⁾Consult your Timken engineer for instructions on use or review the Timken Engineering Manual on timken.com/catalogs.

⁽³⁾Based on 90 x 10⁶ revolutions L₁₀ life, for The Timken Company life-calculation method. C₉₀ and C_{a90} are radial and thrust values.

Bearing Dimensions											Geometry Factors			Bearing Weight
Width B	Width C	Eff. Ctr. a ⁽⁴⁾	Shaft			Housing			Cage		G ₁	G ₂	C _g	
			Max Shaft Fillet Radius R ⁽⁵⁾	Backing Shoulder Dia. d _a	Backing Shoulder Dia. d _b	Max Housing Fillet Radius r ⁽⁵⁾	Backing Shoulder Dia. D _a	Backing Shoulder Dia. D _b	A _a ⁽⁶⁾	A _b ⁽⁷⁾				
mm in.	mm in.	mm in.	mm in.	mm in.	mm in.	mm in.	mm in.	mm in.	mm in.	mm in.				kg lbs.
23.698 0.9330	18.512 0.7288	-2.5 -0.10	3.5 0.14	47.0 1.85	53.0 2.09	1.5 0.06	75.0 2.95	68.0 2.68	3.2 0.12	1.5 0.06	24.6	12.6	0.0839	0.55 1.22
30.391 1.1965	23.812 0.9375	-10.9 -0.43	0.8 0.03	44.5 1.75	45.0 1.77	1.5 0.06	74.8 2.94	71.0 2.80	1.8 0.07	1.1 0.05	34.6	12.1	0.0744	0.67 1.50
25.400 1.0000	20.638 0.8125	-7.4 -0.29	0.8 0.03	44.5 1.75	45.0 1.77	3.3 0.13	74.0 2.91	69.0 2.72	1.4 0.05	1.3 0.05	32.8	13.3	0.0770	0.59 1.32
25.400 1.0000	20.638 0.8125	-7.4 -0.29	0.8 0.03	44.5 1.75	45.0 1.77	0.8 0.03	74.0 2.91	71.0 2.80	1.4 0.05	1.3 0.05	32.8	13.3	0.0770	0.60 1.34
22.403 0.8820	23.812 0.9375	-6.4 -0.25	3.5 0.14	44.0 1.73	50.0 1.97	3.3 0.13	75.0 2.95	70.0 2.76	0.7 0.02	1.1 0.05	26.5	13.0	0.0676	0.55 1.23
30.391 1.1965	23.812 0.9375	-10.9 -0.43	3.5 0.14	44.5 1.75	51.0 2.01	0.8 0.03	74.8 2.94	72.0 2.83	1.8 0.07	1.1 0.05	34.6	12.1	0.0744	0.68 1.51
30.391 1.1965	23.812 0.9375	-10.9 -0.43	3.5 0.14	44.5 1.75	51.0 2.01	3.3 0.13	75.0 2.95	70.0 2.76	1.8 0.07	1.1 0.05	34.6	12.1	0.0744	0.67 1.49
30.391 1.1965	23.812 0.9375	-10.9 -0.43	0.8 0.03	44.5 1.75	45.0 1.77	3.3 0.13	75.0 2.95	70.0 2.76	1.8 0.07	1.1 0.05	34.6	12.1	0.0744	0.67 1.49
30.391 1.1965	23.812 0.9375	-10.9 -0.43	3.5 0.14	44.5 1.75	51.0 2.01	3.3 0.13	75.0 2.95	71.0 2.80	1.8 0.07	1.1 0.05	34.6	12.1	0.0744	0.71 1.57
30.391 1.1965	23.812 0.9375	-10.9 -0.43	0.8 0.03	44.5 1.75	45.0 1.77	3.3 0.13	75.0 2.95	71.0 2.80	1.8 0.07	1.1 0.05	34.6	12.1	0.0744	0.71 1.57
28.575 1.1250	23.020 0.9063	-4.8 -0.19	0.8 0.03	49.1 1.93	51.0 2.01	3.3 0.13	78.0 3.07	68.0 2.68	2.1 0.08	1.9 0.08	33.7	14.0	0.0928	0.76 1.68
28.575 1.1250	23.020 0.9063	-4.8 -0.19	2.3 0.09	49.1 1.93	54.0 2.13	3.3 0.13	78.0 3.07	68.0 2.68	2.1 0.08	1.9 0.08	33.7	14.0	0.0928	0.76 1.68
28.575 1.1250	23.020 0.9063	-4.8 -0.19	0.8 0.03	49.1 1.93	51.0 2.01	0.8 0.03	78.0 3.07	70.0 2.76	2.1 0.08	1.9 0.08	33.7	14.0	0.0928	0.77 1.71
25.400 1.0000	19.050 0.7500	-6.4 -0.25	0.8 0.03	46.0 1.81	46.0 1.81	0.8 0.03	77.0 3.03	74.0 2.91	1.0 0.04	0.7 0.03	35.2	14.3	0.0801	0.65 1.42
25.400 1.0000	19.050 0.7500	-6.4 -0.25	0.8 0.03	46.0 1.81	46.0 1.81	2.3 0.09	78.0 3.07	74.0 2.91	1.0 0.04	0.7 0.03	35.2	14.3	0.0801	0.69 1.50
30.162 1.1875	23.812 0.9375	-8.1 -0.32	0.8 0.03	48.5 1.91	49.5 1.95	3.3 0.13	81.0 3.19	73.0 2.87	1.4 0.05	2.2 0.09	37.8	13.5	0.0873	0.85 1.87
30.162 1.1875	23.812 0.9375	-8.1 -0.32	3.5 0.14	48.5 1.91	55.0 2.17	1.3 0.05	81.0 3.19	75.0 2.95	1.4 0.05	2.2 0.09	37.8	13.5	0.0873	0.85 1.88

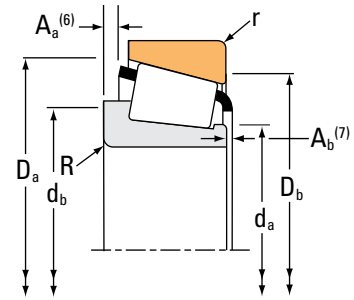
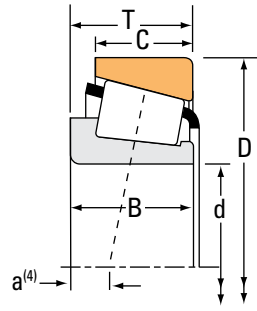
(4) Negative value indicates effective center inside cone (inner-ring) backface.
 (5) These maximum fillet radii will be cleared by the bearing corners.
 (6) Negative value indicates cage extends beyond cone (inner-ring) backface.
 (7) Negative value indicates cage that does not extend beyond cone (inner-ring) front face.

Continued on next page.

TAPERED ROLLER BEARINGS

SINGLE-ROW • TYPE TS

TYPE TS



Bearing Dimensions			Load Ratings							Part Number			
Bore d	O.D. D	Width T	Dynamic ⁽¹⁾		Factors ⁽²⁾		Dynamic ⁽³⁾		Factors ⁽²⁾		Static C ₀	Inner	Outer
			C ₁	e	Y	C ₉₀	C _{a90}	K	N	N			
mm in.	mm in.	mm in.	N lbf			N lbf	N lbf		N lbf				
38.100 1.5000	85.725 3.3750	30.162 1.1875	124000 27900	0.40	1.49	32200 7240	22200 4980	1.45	148000 33200			3876	3820
38.100 1.5000	87.312 3.4375	30.162 1.1875	113000 25500	0.31	1.96	29400 6610	15400 3460	1.91	134000 30100			3580	3525
38.100 1.5000	87.312 3.4375	30.162 1.1875	113000 25500	0.31	1.96	29400 6610	15400 3460	1.91	134000 30100			3583	3525
38.100 1.5000	88.500 3.4843	25.400 1.0000	99800 22400	0.78	0.77	25900 5810	34600 7770	0.75	88600 19900			44150	44348
38.100 1.5000	88.500 3.4843	26.988 1.0625	116000 26000	0.26	2.28	30000 6740	13500 3040	2.22	124000 28000			418	414
38.100 1.5000	88.500 3.4843	26.988 1.0625	116000 26000	0.26	2.28	30000 6740	13500 3040	2.22	124000 28000			418	414A
38.100 1.5000	88.900 3.5000	26.988 1.0625	116000 26000	0.26	2.28	30000 6740	13500 3040	2.22	124000 28000			418	414X
38.100 1.5000	90.488 3.5625	39.688 1.5625	199000 44700	0.28	2.11	51500 11600	25100 5640	2.05	204000 45900			4375	4335
38.100 1.5000	93.662 3.6875	31.750 1.2500	136000 30500	0.36	1.67	35200 7900	21700 4870	1.62	156000 35000			49151	49368
38.100 1.5000	95.250 3.7500	27.782 1.0938	127000 28500	0.28	2.11	32900 7400	16000 3600	2.05	144000 32400			440	432
38.100 1.5000	95.250 3.7500	27.783 1.0938	127000 28500	0.28	2.11	32900 7400	16000 3600	2.05	144000 32400			444	432
38.100 1.5000	95.250 3.7500	27.783 1.0938	130000 29200	0.33	1.82	33600 7560	19000 4270	1.77	161000 36200			33880	33821
38.100 1.5000	95.250 3.7500	30.958 1.2188	119000 26700	0.74	0.81	30800 6920	39000 8760	0.79	104000 23400			53150	53375
38.100 1.5000	98.425 3.8750	30.958 1.2188	119000 26700	0.74	0.81	30800 6920	39000 8760	0.79	104000 23400			53150	53387
38.100 1.5000	101.600 4.0000	34.925 1.3750	165000 37000	0.29	2.10	42700 9600	20800 4690	2.05	191000 43000			525	522
38.100 1.5000	101.600 4.0000	34.925 1.3750	165000 37000	0.29	2.10	42700 9600	20800 4690	2.05	191000 43000			525X	522
38.100 1.5000	103.188 4.0625	38.100 1.5000	172000 38700	0.30	2.02	44600 10000	22700 5090	1.97	206000 46200			542	533A

⁽¹⁾Based on 1 x 10⁶ revolutions L₁₀ life, for the ISO life-calculation method.

⁽²⁾Consult your Timken engineer for instructions on use or review the Timken Engineering Manual on timken.com/catalogs.

⁽³⁾Based on 90 x 10⁶ revolutions L₁₀ life, for The Timken Company life-calculation method. C₉₀ and C_{a90} are radial and thrust values.

Bearing Dimensions											Geometry Factors			Bearing Weight
Width B	Width C	Eff. Ctr. a ⁽⁴⁾	Shaft			Housing			Cage		G ₁	G ₂	C _g	
			Max Shaft Fillet Radius R ⁽⁵⁾	Backing Shoulder Dia. d _a	Shoulder Dia. d _b	Max Housing Fillet Radius r ⁽⁵⁾	Backing Shoulder Dia. D _a	Shoulder Dia. D _b	A _a ⁽⁶⁾	A _b ⁽⁷⁾				
mm in.	mm in.	mm in.	mm in.	mm in.	mm in.	mm in.	mm in.	mm in.	mm in.	mm in.				kg lbs.
30.162 1.1875	23.812 0.9375	-8.1 -0.32	3.5 0.14	48.5 1.91	55.0 2.17	3.3 0.13	81.0 3.19	73.0 2.87	1.4 0.05	2.2 0.09	37.8	13.5	0.0873	0.84 1.86
30.886 1.2160	23.812 0.9375	-10.2 -0.40	1.5 0.06	45.5 1.79	48.0 1.89	3.3 0.13	81.0 3.19	75.0 2.95	2.2 0.09	0.7 0.03	39.5	12.5	0.0808	0.88 1.91
30.886 1.2160	23.812 0.9375	-10.2 -0.40	3.5 0.14	45.5 1.79	52.0 2.05	3.3 0.13	81.0 3.19	75.0 2.95	2.2 0.09	0.7 0.03	39.5	12.5	0.0808	0.87 1.90
23.698 0.9330	17.462 0.6875	2.3 0.09	2.3 0.09	50.8 2.00	55.0 2.17	1.5 0.06	84.0 3.31	75.0 2.95	3.8 0.15	2.7 0.11	22.9	8.7	0.0899	0.71 1.56
29.083 1.1450	22.225 0.8750	-9.7 -0.38	3.5 0.14	44.5 1.75	51.0 2.01	1.5 0.06	80.0 3.15	77.0 3.03	1.2 0.04	0.8 0.03	34.4	9.9	0.0731	0.83 1.81
29.083 1.1450	22.225 0.8750	-9.7 -0.38	3.5 0.14	44.5 1.75	51.0 2.01	3.3 0.13	80.0 3.15	76.0 2.99	1.2 0.04	0.8 0.03	34.4	9.9	0.0731	0.82 1.80
29.083 1.1450	22.225 0.8750	-9.7 -0.38	3.5 0.14	44.5 1.75	51.0 2.01	0.8 0.03	80.0 3.15	77.5 3.07	1.2 0.04	0.8 0.03	34.4	9.9	0.0731	0.84 1.84
40.386 1.5900	33.338 1.3125	-15.0 -0.59	1.5 0.06	51.0 2.01	53.0 2.09	3.3 0.13	85.0 3.35	77.0 3.03	2.2 0.09	0.6 0.03	52.9	14.3	0.0872	1.31 2.89
31.750 1.2500	25.400 1.0000	-9.1 -0.36	0.8 0.03	48.0 1.89	48.5 1.91	3.3 0.13	87.0 3.43	82.0 3.23	2.9 0.11	0.8 0.04	42.4	13.6	0.0872	1.09 2.39
29.900 1.1772	22.225 0.8750	-9.1 -0.36	0.8 0.03	45.5 1.79	46.5 1.83	2.3 0.09	87.0 3.43	83.0 3.27	1.6 0.06	0.5 0.02	42.5	11.3	0.0805	1.04 2.29
29.900 1.1772	22.225 0.8750	-9.1 -0.36	3.5 0.14	45.5 1.79	52.0 2.05	2.3 0.09	87.0 3.43	83.0 3.27	1.6 0.06	0.5 0.02	42.5	11.3	0.0805	1.03 2.27
28.575 1.1250	22.225 0.8750	-7.6 -0.30	3.5 0.14	48.0 1.89	54.0 2.13	2.3 0.09	90.0 3.54	85.0 3.35	1.3 0.05	2.2 0.09	52.5	18.5	0.0910	1.05 2.31
28.300 1.1142	20.638 0.8125	-0.3 -0.01	1.5 0.06	52.7 2.07	55.0 2.17	0.8 0.03	89.0 3.50	81.0 3.19	5.7 0.22	2.2 0.09	26.7	9.6	0.0930	1.01 2.25
28.300 1.1142	20.638 0.8125	-0.3 -0.01	1.5 0.06	52.7 2.07	55.0 2.17	0.8 0.03	91.0 3.58	82.0 3.23	5.7 0.22	2.2 0.09	26.7	9.6	0.0930	1.09 2.42
36.068 1.4200	26.988 1.0625	-12.7 -0.50	3.5 0.14	48.0 1.89	54.0 2.13	3.3 0.13	95.0 3.74	89.0 3.50	2.7 0.10	1.8 0.07	57.9	13.4	0.0894	1.48 3.26
36.068 1.4200	26.988 1.0625	-12.7 -0.50	0.8 0.03	48.0 1.89	49.0 1.93	3.3 0.13	95.0 3.74	89.0 3.50	2.7 0.10	1.8 0.07	57.9	13.4	0.0894	1.49 3.28
36.957 1.4550	30.162 1.1875	-12.2 -0.48	3.5 0.14	49.0 1.93	55.0 2.17	1.5 0.06	98.0 3.86	93.0 3.66	2.7 0.10	1.0 0.04	64.3	16.1	0.0938	1.65 3.63

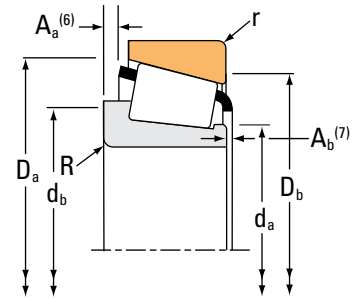
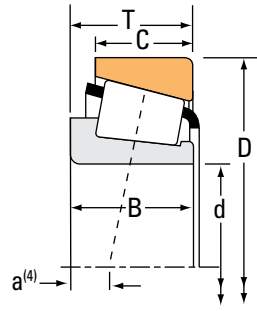
(4) Negative value indicates effective center inside cone (inner-ring) backface.
 (5) These maximum fillet radii will be cleared by the bearing corners.
 (6) Negative value indicates cage extends beyond cone (inner-ring) backface.
 (7) Negative value indicates cage that does not extend beyond cone (inner-ring) front face.

Continued on next page.

TAPERED ROLLER BEARINGS

SINGLE-ROW • TYPE TS

TYPE TS



Bearing Dimensions			Load Ratings							Part Number			
Bore d	O.D. D	Width T	Dynamic ⁽¹⁾		Factors ⁽²⁾		Dynamic ⁽³⁾		Factors ⁽²⁾		Static C ₀	Inner	Outer
			C ₁	e	Y	C ₉₀	C _{a90}	K	N	N			
mm in.	mm in.	mm in.	N lbf			N lbf	N lbf		N lbf				
38.100 1.5000	107.950 4.2500	27.783 1.0938	136000 30500	0.34	1.79	35200 7900	20200 4540	1.74	166000 37200		455A	453A	
38.100 1.5000	111.125 4.3750	38.100 1.5000	172000 38700	0.30	2.02	44600 10000	22700 5090	1.97	206000 46200		542	532A	
38.481 1.5150	63.500 2.5000	12.700 0.5000	27200 6100	0.35	1.73	7040 1580	4170 938	1.69	33000 7430		13890	13830	
38.481 1.5150	65.088 2.5625	12.700 0.5000	27200 6100	0.35	1.73	7040 1580	4170 938	1.69	33000 7430		13890	13836	
39.000 1.5354	72.014 2.8352	21.400 0.8425	56600 12700	0.40	1.49	14700 3300	10100 2270	1.45	65800 14800		J16154	J16285	
39.687 1.5625	73.025 2.8750	16.667 0.6562	50800 11400	0.35	1.71	13200 2960	7890 1770	1.67	58100 13100		18587	18520	
39.687 1.5625	73.025 2.8750	23.812 0.9375	86900 19500	0.30	1.98	22500 5060	11700 2630	1.93	102000 23000		2789	2735X	
39.687 1.5625	73.025 2.8750	25.654 1.0100	73400 16500	0.33	1.80	19000 4280	10800 2440	1.76	89100 20000		M201047	M201011	
39.687 1.5625	76.200 3.0000	23.812 0.9375	86900 19500	0.30	1.98	22500 5060	11700 2630	1.93	102000 23000		2789	2720	
39.687 1.5625	76.200 3.0000	23.812 0.9375	86900 19500	0.30	1.98	22500 5060	11700 2630	1.93	102000 23000		2789	2729	
39.687 1.5625	76.200 3.0000	25.400 1.0000	91100 20500	0.32	1.88	23600 5310	12900 2900	1.83	110000 24800		26881	26823	
39.687 1.5625	79.375 3.1250	23.812 0.9375	91100 20500	0.32	1.88	23600 5310	12900 2900	1.83	110000 24800		26880	26822	
39.687 1.5625	79.375 3.1250	23.812 0.9375	91100 20500	0.32	1.88	23600 5310	12900 2900	1.83	110000 24800		26881	26822	
39.687 1.5625	79.375 3.1250	23.812 0.9375	91100 20500	0.32	1.88	23600 5310	12900 2900	1.83	110000 24800		26880	26822A	
39.688 1.5625	79.975 3.1486	29.370 1.1563	115000 25800	0.27	2.20	29800 6700	13900 3130	2.14	129000 29100		3382	3325	
39.688 1.5625	79.975 3.1486	29.370 1.1563	115000 25800	0.27	2.20	29800 6700	13900 3130	2.14	129000 29100		3386	3325	
39.687 1.5625	80.000 3.1496	23.812 0.9375	91100 20500	0.32	1.88	23600 5310	12900 2900	1.83	110000 24800		26881	26824	

⁽¹⁾Based on 1 x 10⁶ revolutions L₁₀ life, for the ISO life-calculation method.

⁽²⁾Consult your Timken engineer for instructions on use or review the Timken Engineering Manual on timken.com/catalogs.

⁽³⁾Based on 90 x 10⁶ revolutions L₁₀ life, for The Timken Company life-calculation method. C₉₀ and C_{a90} are radial and thrust values.

Bearing Dimensions											Geometry Factors			Bearing Weight
Width B	Width C	Eff. Ctr. a ⁽⁴⁾	Shaft			Housing			Cage		G ₁	G ₂	C _g	
			Max Shaft Fillet Radius R ⁽⁵⁾	Backing Shoulder Dia. d _a	Backing Shoulder Dia. d _b	Max Housing Fillet Radius r ⁽⁵⁾	Backing Shoulder Dia. D _a	Backing Shoulder Dia. D _b	A _a ⁽⁶⁾	A _b ⁽⁷⁾				
mm in.	mm in.	mm in.	mm in.	mm in.	mm in.	mm in.	mm in.	mm in.	mm in.	mm in.				kg lbs.
29.317 1.1542	22.225 0.8750	-7.1 -0.28	3.5 0.14	49.5 1.95	56.0 2.20	0.8 0.03	100.0 3.94	97.0 3.82	2.1 0.08	1.4 0.06	58.6	17.1	0.0946	1.43 3.14
36.957 1.4550	30.162 1.1875	-12.2 -0.48	3.5 0.14	49.0 1.93	55.0 2.17	3.3 0.13	100.0 3.94	95.0 3.74	2.7 0.10	1.0 0.04	64.3	16.1	0.0938	1.96 4.30
11.908 0.4688	9.525 0.3750	-0.8 -0.03	0.4 0.02	43.0 1.69	43.0 1.69	0.8 0.03	60.0 2.36	59.0 2.32	0.2 0.00	1.4 0.06	14.8	23.3	0.0601	0.14 0.32
11.908 0.4688	9.525 0.3750	-0.8 -0.03	0.4 0.02	43.0 1.69	43.0 1.69	0.8 0.03	61.0 2.40	59.0 2.32	0.2 0.00	1.4 0.06	14.8	23.3	0.0601	0.16 0.35
20.638 0.8125	16.637 0.6550	-4.1 -0.16	3.5 0.14	44.5 1.75	51.0 2.01	0.4 0.02	67.0 2.64	63.0 2.48	1.1 0.04	1.1 0.05	20.3	14.5	0.0707	0.35 0.79
17.462 0.6875	12.700 0.5000	-2.8 -0.11	0.8 0.03	45.0 1.77	45.5 1.79	1.5 0.06	69.0 2.72	66.0 2.60	0.4 0.01	1.3 0.05	21.0	16.8	0.0681	0.30 0.65
25.654 1.0100	19.050 0.7500	-8.1 -0.32	3.5 0.14	45.0 1.77	52.0 2.05	0.8 0.03	69.0 2.72	66.0 2.60	1.4 0.05	0.9 0.04	28.7	12.2	0.0725	0.43 0.95
22.098 0.8700	21.336 0.8400	-5.8 -0.23	0.8 0.03	48.0 1.89	45.5 1.79	2.3 0.09	69.0 2.72	64.0 2.52	0.4 0.01	2.0 0.08	27.5	15.0	0.0736	0.44 0.94
25.654 1.0100	19.050 0.7500	-8.1 -0.32	3.5 0.14	45.0 1.77	52.0 2.05	3.3 0.13	70.0 2.76	66.0 2.60	1.4 0.05	0.9 0.04	28.7	12.2	0.0725	0.48 1.05
25.654 1.0100	19.050 0.7500	-8.1 -0.32	3.5 0.14	45.0 1.77	52.0 2.05	0.8 0.03	70.0 2.76	68.0 2.68	1.4 0.05	0.9 0.04	28.7	12.2	0.0725	0.49 1.07
25.400 1.0000	20.638 0.8125	-7.4 -0.29	3.5 0.14	45.5 1.79	52.0 2.05	1.5 0.06	73.0 2.87	69.0 2.72	1.4 0.05	1.3 0.05	32.8	13.3	0.0770	0.50 1.10
25.400 1.0000	19.050 0.7500	-7.4 -0.29	1.5 0.06	45.5 1.79	48.0 1.89	0.8 0.03	74.0 2.91	71.0 2.80	1.4 0.05	1.3 0.05	32.8	13.3	0.0770	0.54 1.21
25.400 1.0000	19.050 0.7500	-7.4 -0.29	3.5 0.14	45.5 1.79	52.0 2.05	0.8 0.03	74.0 2.91	71.0 2.80	1.4 0.05	1.3 0.05	32.8	13.3	0.0770	0.54 1.20
25.400 1.0000	19.050 0.7500	-7.4 -0.29	1.5 0.06	45.5 1.79	48.0 1.89	2.3 0.09	74.0 2.91	69.0 2.72	1.4 0.05	1.3 0.05	32.8	13.3	0.0770	0.54 1.20
30.391 1.1965	23.812 0.9375	-10.9 -0.43	3.5 0.14	45.5 1.79	52.0 2.05	3.3 0.13	74.8 2.94	70.0 2.76	1.8 0.07	1.1 0.05	34.6	12.1	0.0744	0.65 1.43
30.391 1.1965	23.812 0.9375	-10.9 -0.43	0.8 0.03	45.5 1.79	46.5 1.83	3.3 0.13	74.8 2.94	70.0 2.76	1.8 0.07	1.1 0.05	34.6	12.1	0.0744	0.65 1.43
25.400 1.0000	19.050 0.7500	-7.4 -0.29	3.5 0.14	45.5 1.79	52.0 2.05	1.3 0.05	74.0 2.91	70.0 2.76	1.4 0.05	1.3 0.05	32.8	13.3	0.0770	0.56 1.22

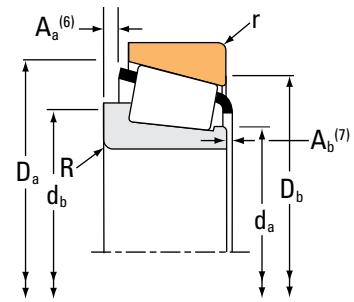
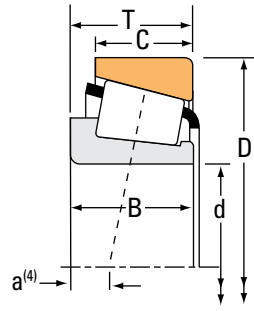
⁽⁴⁾Negative value indicates effective center inside cone (inner-ring) backface.
⁽⁵⁾These maximum fillet radii will be cleared by the bearing corners.
⁽⁶⁾Negative value indicates cage extends beyond cone (inner-ring) backface.
⁽⁷⁾Negative value indicates cage that does not extend beyond cone (inner-ring) front face.

Continued on next page.

TAPERED ROLLER BEARINGS

SINGLE-ROW • TYPE TS

TYPE TS



Bearing Dimensions			Load Ratings							Part Number			
Bore d	O.D. D	Width T	Dynamic ⁽¹⁾		Factors ⁽²⁾		Dynamic ⁽³⁾		Factors ⁽²⁾		Static C ₀	Inner	Outer
			C ₁	e	Y	C ₉₀	C _{a90}	K	N	N			
mm in.	mm in.	mm in.	N lbf			N lbf	N lbf		N lbf				
39.688 1.5625	80.035 3.1510	29.370 1.1563	115000 25800	0.27	2.20	29800 6700	13900 3130	2.14	129000 29100			3386	3339
39.687 1.5625	80.167 3.1562	25.400 1.0000	91100 20500	0.32	1.88	23600 5310	12900 2900	1.83	110000 24800			26881	26820
39.687 1.5625	80.167 3.1562	25.400 1.0000	91100 20500	0.32	1.88	23600 5310	12900 2900	1.83	110000 24800			26880	26830
39.687 1.5625	80.167 3.1562	25.400 1.0000	91100 20500	0.32	1.88	23600 5310	12900 2900	1.83	110000 24800			26880	26820
39.687 1.5625	80.167 3.1562	25.400 1.0000	91100 20500	0.32	1.88	23600 5310	12900 2900	1.83	110000 24800			26881	26830
39.687 1.5625	80.167 3.1562	29.370 1.1563	91100 20500	0.32	1.88	23600 5310	12900 2900	1.83	110000 24800			26880	26821
39.688 1.5625	80.167 3.1562	29.370 1.1563	115000 25800	0.27	2.20	29800 6700	13900 3130	2.14	129000 29100			3382	3331
39.688 1.5625	80.167 3.1562	29.370 1.1563	115000 25800	0.27	2.20	29800 6700	13900 3130	2.14	129000 29100			3382	3320
39.688 1.5625	80.167 3.1562	29.370 1.1563	115000 25800	0.27	2.20	29800 6700	13900 3130	2.14	129000 29100			3386	3331
39.688 1.5625	80.167 3.1562	29.370 1.1563	115000 25800	0.27	2.20	29800 6700	13900 3130	2.14	129000 29100			3386	3320
39.688 1.5625	84.138 3.3125	29.370 1.1563	115000 25800	0.27	2.20	29800 6700	13900 3130	2.14	129000 29100			3386	3328
39.688 1.5625	84.138 3.3125	29.370 1.1563	115000 25800	0.27	2.20	29800 6700	13900 3130	2.14	129000 29100			3382	3328
39.687 1.5625	88.500 3.4843	25.400 1.0000	99800 22400	0.78	0.77	25900 5810	34600 7770	0.75	88600 19900			44156	44348
39.687 1.5625	88.500 3.4843	25.400 1.0000	99800 22400	0.78	0.77	25900 5810	34600 7770	0.75	88600 19900			44158	44348
39.687 1.5625	120.650 4.7500	41.275 1.6250	207000 46600	0.31	1.91	53800 12100	28900 6510	1.86	244000 54800			620	612
39.980 1.5740	76.200 3.0000	19.347 0.7617	75200 16900	0.40	1.49	19500 4390	13400 3020	1.45	68900 15500			28156	28300
39.980 1.5740	76.200 3.0000	20.638 0.8125	63500 14300	0.40	1.49	16500 3700	11300 2550	1.45	68900 15500			28159	28300

⁽¹⁾Based on 1 x 10⁶ revolutions L₁₀ life, for the ISO life-calculation method.

⁽²⁾Consult your Timken engineer for instructions on use or review the Timken Engineering Manual on timken.com/catalogs.

⁽³⁾Based on 90 x 10⁶ revolutions L₁₀ life, for The Timken Company life-calculation method. C₉₀ and C_{a90} are radial and thrust values.

Bearing Dimensions											Geometry Factors			Bearing Weight
Width B	Width C	Eff. Ctr. a ⁽⁴⁾	Shaft			Housing			Cage		G ₁	G ₂	C _g	
			Max Shaft Fillet Radius R ⁽⁵⁾	Backing Shoulder Dia. d _a	Backing Shoulder Dia. d _b	Max Housing Fillet Radius r ⁽⁵⁾	Backing Shoulder Dia. D _a	Backing Shoulder Dia. D _b	A _a ⁽⁶⁾	A _b ⁽⁷⁾				
mm in.	mm in.	mm in.	mm in.	mm in.	mm in.	mm in.	mm in.	mm in.	mm in.	mm in.				kg lbs.
30.391 1.1965	23.812 0.9375	-10.9 -0.43	0.8 0.03	45.5 1.79	46.5 1.83	1.5 0.06	74.8 2.94	71.0 2.80	1.8 0.07	1.1 0.05	34.6	12.1	0.0744	0.65 1.45
25.400 1.0000	20.638 0.8125	-7.4 -0.29	3.5 0.14	45.5 1.79	52.0 2.05	3.3 0.13	74.0 2.91	69.0 2.72	1.4 0.05	1.3 0.05	32.8	13.3	0.0770	0.57 1.26
25.400 1.0000	20.638 0.8125	-7.4 -0.29	1.5 0.06	45.5 1.79	48.0 1.89	0.8 0.03	74.0 2.91	71.0 2.80	1.4 0.05	1.3 0.05	32.8	13.3	0.0770	0.58 1.29
25.400 1.0000	20.638 0.8125	-7.4 -0.29	1.5 0.06	45.5 1.79	48.0 1.89	3.3 0.13	74.0 2.91	69.0 2.72	1.4 0.05	1.3 0.05	32.8	13.3	0.0770	0.57 1.27
25.400 1.0000	20.638 0.8125	-7.4 -0.29	3.5 0.14	45.5 1.79	52.0 2.05	0.8 0.03	74.0 2.91	71.0 2.80	1.4 0.05	1.3 0.05	32.8	13.3	0.0770	0.58 1.28
25.400 1.0000	24.608 0.9688	-7.4 -0.29	1.5 0.06	45.5 1.79	48.0 1.89	3.3 0.13	74.0 2.91	68.0 2.68	1.4 0.05	1.3 0.05	32.8	13.3	0.0770	0.63 1.40
30.391 1.1965	23.812 0.9375	-10.9 -0.43	3.5 0.14	45.5 1.79	52.0 2.05	0.8 0.03	74.8 2.94	72.0 2.83	1.8 0.07	1.1 0.05	34.6	12.1	0.0744	0.66 1.46
30.391 1.1965	23.812 0.9375	-10.9 -0.43	3.5 0.14	45.5 1.79	52.0 2.05	3.3 0.13	75.0 2.95	70.0 2.76	1.8 0.07	1.1 0.05	34.6	12.1	0.0744	0.65 1.44
30.391 1.1965	23.812 0.9375	-10.9 -0.43	0.8 0.03	45.5 1.79	46.5 1.83	0.8 0.03	74.8 2.94	72.0 2.83	1.8 0.07	1.1 0.05	34.6	12.1	0.0744	0.66 1.46
30.391 1.1965	23.812 0.9375	-10.9 -0.43	0.8 0.03	45.5 1.79	46.5 1.83	3.3 0.13	75.0 2.95	70.0 2.76	1.8 0.07	1.1 0.05	34.6	12.1	0.0744	0.65 1.44
30.391 1.1965	23.812 0.9375	-10.9 -0.43	0.8 0.03	45.5 1.79	46.5 1.83	3.3 0.13	76.0 2.99	72.0 2.83	1.8 0.07	1.1 0.05	34.6	12.1	0.0744	0.74 1.65
30.391 1.1965	23.812 0.9375	-10.9 -0.43	3.5 0.14	45.5 1.79	52.0 2.05	3.3 0.13	76.0 2.99	72.0 2.83	1.8 0.07	1.1 0.05	34.6	12.1	0.0744	0.74 1.64
23.698 0.9330	17.462 0.6875	2.3 0.09	2.3 0.09	50.8 2.00	56.0 2.20	1.5 0.06	84.0 3.31	75.0 2.95	3.8 0.15	2.7 0.11	22.9	8.7	0.0899	0.69 1.52
23.698 0.9330	17.462 0.6875	2.3 0.09	3.5 0.14	50.8 2.00	58.0 2.28	1.5 0.06	84.0 3.31	75.0 2.95	3.8 0.15	2.7 0.11	22.9	8.7	0.0899	0.69 1.51
41.275 1.6250	31.750 1.2500	-14.0 -0.55	0.8 0.03	52.0 2.05	53.0 2.09	3.3 0.13	110.0 4.33	105.0 4.13	3.8 0.15	1.9 0.08	75.9	16.2	0.0694	2.53 5.58
19.650 0.7736	15.507 0.6105	-3.6 -0.14	2.3 0.09	45.0 1.77	49.0 1.93	1.3 0.05	71.0 2.80	68.0 2.68	1.0 0.04	1.1 0.05	20.7	12.5	0.0709	0.37 0.81
20.940 0.8244	15.507 0.6105	-4.8 -0.19	3.5 0.14	45.0 1.77	52.0 2.05	1.3 0.05	71.0 2.80	68.0 2.68	2.3 0.09	1.1 0.05	20.7	12.5	0.0709	0.37 0.83

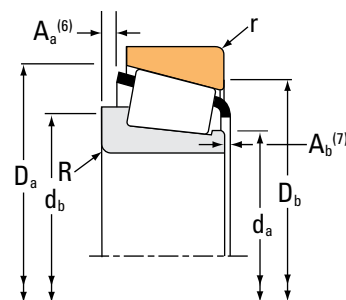
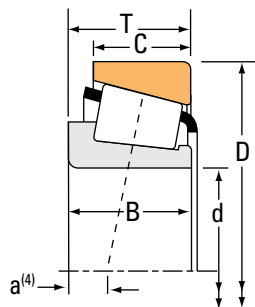
⁽⁴⁾Negative value indicates effective center inside cone (inner-ring) backface.
⁽⁵⁾These maximum fillet radii will be cleared by the bearing corners.
⁽⁶⁾Negative value indicates cage extends beyond cone (inner-ring) backface.
⁽⁷⁾Negative value indicates cage that does not extend beyond cone (inner-ring) front face.

Continued on next page.

TAPERED ROLLER BEARINGS

SINGLE-ROW • TYPE TS

TYPE TS



Bearing Dimensions			Load Ratings							Part Number			
Bore d	O.D. D	Width T	Dynamic ⁽¹⁾		Factors ⁽²⁾		Dynamic ⁽³⁾		Factors ⁽²⁾		Static C ₀	Inner	Outer
			C ₁	e	Y	C ₉₀	C _{a90}	K	N	N			
mm in.	mm in.	mm in.	N lbf			N lbf	N lbf		N lbf				
39.980 1.5740	80.035 3.1510	20.142 0.7930	75200 16900	0.40	1.49	19500 4390	13400 3020	1.45	68900 15500		28156	28317	
39.987 1.5743	90.975 3.5817	32.000 1.2598	170000 38300	0.33	1.80	44200 9930	25200 5660	1.76	172000 38600		HM204043	HM204010	
40.000 1.5748	76.200 3.0000	20.625 0.8120	75200 16900	0.40	1.49	19500 4390	13400 3020	1.45	68900 15500		28158	28300X	
40.000 1.5748	80.000 3.1496	21.000 0.8268	94300 21200	0.27	2.20	24400 5490	11400 2570	2.14	83400 18700		344A	332	
40.000 1.5748	80.000 3.1496	21.005 0.8270	75200 16900	0.40	1.49	19500 4390	13400 3020	1.45	68900 15500		28158	28315	
40.000 1.5748	80.000 3.1496	21.006 0.8270	75200 16900	0.40	1.49	19500 4390	13400 3020	1.45	68900 15500		28158	28315A	
40.000 1.5748	84.138 3.3125	26.988 1.0625	81800 18400	0.31	1.96	21200 4770	11100 2500	1.91	88800 20000		350	3520	
40.000 1.5748	85.000 3.3465	20.638 0.8125	81800 18400	0.31	1.96	21200 4770	11100 2500	1.91	88800 20000		350	354A	
40.000 1.5748	85.000 3.3465	20.638 0.8125	81800 18400	0.31	1.96	21200 4770	11100 2500	1.91	88800 20000		350	354X	
40.000 1.5748	85.000 3.3465	20.638 0.8125	97000 21800	0.31	1.96	25100 5650	13200 2960	1.91	88800 20000		357	354A	
40.000 1.5748	85.000 3.3465	33.000 1.2992	162000 36500	0.34	1.74	42100 9470	24800 5580	1.70	160000 35900		JF4049	JF4010	
40.000 1.5748	85.725 3.3750	30.162 1.1875	124000 27900	0.40	1.49	32200 7240	22200 4980	1.45	148000 33200		3879	3820	
40.000 1.5748	87.312 3.4375	30.162 1.1875	113000 25500	0.31	1.96	29400 6610	15400 3460	1.91	134000 30100		3582	3525	
40.000 1.5748	88.500 3.4843	24.765 0.9750	99800 22400	0.78	0.77	25900 5810	34600 7770	0.75	88600 19900		44157X	44348	
40.000 1.5748	88.500 3.4843	26.988 1.0625	116000 26000	0.26	2.28	30000 6740	13500 3040	2.22	124000 28000		420	414	
40.000 1.5748	88.900 3.5000	26.988 1.0625	116000 26000	0.26	2.28	30000 6740	13500 3040	2.22	124000 28000		420	414X	
40.000 1.5748	90.000 3.5433	23.000 0.9055	81800 18400	0.31	1.96	21200 4770	11100 2500	1.91	88800 20000		350	352X	

⁽¹⁾Based on 1 x 10⁶ revolutions L₁₀ life, for the ISO life-calculation method.

⁽²⁾Consult your Timken engineer for instructions on use or review the Timken Engineering Manual on timken.com/catalogs.

⁽³⁾Based on 90 x 10⁶ revolutions L₁₀ life, for The Timken Company life-calculation method. C₉₀ and C_{a90} are radial and thrust values.

Bearing Dimensions											Geometry Factors			Bearing Weight
Width B	Width C	Eff. Ctr. a ⁽⁴⁾	Shaft			Housing			Cage		G ₁	G ₂	C _g	
			Max Shaft Fillet Radius R ⁽⁵⁾	Backing Shoulder Dia. d _a	Shoulder Dia. d _b	Max Housing Fillet Radius r ⁽⁵⁾	Backing Shoulder Dia. D _a	Shoulder Dia. D _b	A _a ⁽⁶⁾	A _b ⁽⁷⁾				
mm in.	mm in.	mm in.	mm in.	mm in.	mm in.	mm in.	mm in.	mm in.	mm in.	mm in.				kg lbs.
19.650 0.7736	15.875 0.6250	-3.6 -0.14	2.3 0.09	45.0 1.77	49.0 1.93	1.5 0.06	73.0 2.87	69.0 2.72	1.0 0.04	1.1 0.05	20.7	12.5	0.0709	0.43 0.95
32.000 1.2598	26.500 1.0433	-9.7 -0.38	1.0 0.04	53.0 2.09	54.0 2.13	3.5 0.14	86.0 3.39	79.0 3.11	1.5 0.06	1.9 0.08	47.7	14.5	0.0885	1.02 2.26
20.940 0.8244	15.494 0.6100	-4.8 -0.19	1.5 0.06	45.0 1.77	47.5 1.87	1.5 0.06	71.0 2.80	68.0 2.68	2.3 0.09	1.1 0.05	20.7	12.5	0.0709	0.38 0.85
22.403 0.8820	17.826 0.7018	-6.4 -0.25	0.8 0.03	45.5 1.79	46.0 1.81	1.3 0.05	75.0 2.95	73.0 2.87	0.7 0.02	1.1 0.05	26.5	13.0	0.0676	0.47 1.05
20.940 0.8244	15.875 0.6250	-4.8 -0.19	1.5 0.06	45.0 1.77	47.5 1.87	1.5 0.06	73.0 2.87	69.0 2.72	2.3 0.09	1.1 0.05	20.7	12.5	0.0709	0.44 0.98
20.940 0.8244	15.875 0.6250	-4.8 -0.19	1.5 0.06	45.0 1.77	47.5 1.87	2.0 0.08	73.0 2.87	69.0 2.72	2.3 0.09	1.1 0.05	20.7	12.5	0.0709	0.44 0.97
21.692 0.8540	23.812 0.9375	-4.8 -0.19	4.0 0.16	46.5 1.83	54.0 2.13	3.3 0.13	79.5 3.13	74.0 2.91	0.4 0.01	1.7 0.07	30.0	12.2	0.0732	0.61 1.35
21.692 0.8540	17.462 0.6875	-4.8 -0.19	4.0 0.16	46.5 1.83	54.0 2.13	1.3 0.05	80.0 3.15	77.0 3.03	0.4 0.01	1.7 0.07	30.0	12.2	0.0732	0.55 1.22
21.692 0.8540	17.462 0.6875	-4.8 -0.19	4.0 0.16	46.5 1.83	54.0 2.13	1.5 0.06	80.0 3.15	77.0 3.03	0.4 0.01	1.7 0.07	30.0	12.2	0.0732	0.55 1.23
21.692 0.8540	17.462 0.6875	-4.8 -0.19	2.3 0.09	46.5 1.83	51.0 2.01	1.3 0.05	80.0 3.15	77.0 3.03	0.4 0.01	1.7 0.07	30.0	12.2	0.0732	0.56 1.23
32.500 1.2795	28.000 1.1024	-10.2 -0.40	2.5 0.10	49.0 1.93	55.0 2.17	2.0 0.08	80.0 3.15	75.0 2.95	1.1 0.04	2.0 0.08	39.5	13.6	0.0841	0.90 1.99
30.162 1.1875	23.812 0.9375	-8.1 -0.32	0.8 0.03	50.0 1.97	51.0 2.01	3.3 0.13	81.0 3.19	73.0 2.87	1.4 0.05	2.2 0.09	37.8	13.5	0.0873	0.82 1.81
30.886 1.2160	23.812 0.9375	-10.2 -0.40	3.5 0.14	47.0 1.85	53.0 2.09	3.3 0.13	81.0 3.19	75.0 2.95	2.2 0.09	0.7 0.03	39.5	12.5	0.0808	0.84 1.84
23.063 0.9080	17.462 0.6875	3.0 0.12	2.3 0.09	50.8 2.00	56.0 2.20	1.5 0.06	84.0 3.31	75.0 2.95	3.3 0.13	3.0 0.12	22.9	8.7	0.0899	0.68 1.50
29.083 1.1450	22.225 0.8750	-9.7 -0.38	3.5 0.14	46.0 1.81	52.0 2.05	1.5 0.06	80.0 3.15	77.0 3.03	1.2 0.04	0.8 0.03	34.4	9.9	0.0731	0.80 1.76
29.083 1.1450	22.225 0.8750	-9.7 -0.38	3.5 0.14	46.0 1.81	52.0 2.05	0.8 0.03	80.0 3.15	77.5 3.07	1.2 0.04	0.8 0.03	34.4	9.9	0.0731	0.81 1.78
21.692 0.8540	21.808 0.8586	-4.8 -0.19	4.0 0.16	46.5 1.83	54.0 2.13	2.3 0.09	82.0 3.23	78.0 3.07	0.4 0.01	1.7 0.07	30.0	12.2	0.0732	0.70 1.56

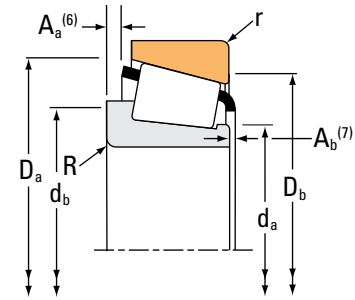
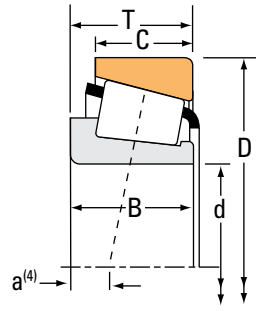
⁽⁴⁾Negative value indicates effective center inside cone (inner-ring) backface.
⁽⁵⁾These maximum fillet radii will be cleared by the bearing corners.
⁽⁶⁾Negative value indicates cage extends beyond cone (inner-ring) backface.
⁽⁷⁾Negative value indicates cage that does not extend beyond cone (inner-ring) front face.

Continued on next page.

TAPERED ROLLER BEARINGS

SINGLE-ROW • TYPE TS

TYPE TS



Bearing Dimensions			Load Ratings							Part Number			
Bore d	O.D. D	Width T	Dynamic ⁽¹⁾		Factors ⁽²⁾		Dynamic ⁽³⁾		Factors ⁽²⁾		Static C ₀	Inner	Outer
			C ₁	e	Y	C ₉₀	C _{a90}	K	N	N			
mm in.	mm in.	mm in.	N lbf			N lbf	N lbf		N lbf				
40.000 1.5748	90.119 3.5480	23.000 0.9055	81800 18400	0.31	1.96	21200 4770	11100 2500	1.91	88800 20000			350	352
40.000 1.5748	90.119 3.5480	23.000 0.9055	97000 21800	0.31	1.96	25100 5650	13200 2960	1.91	88800 20000			350A	352
40.000 1.5748	90.119 3.5480	23.000 0.9055	97000 21800	0.31	1.96	25100 5650	13200 2960	1.91	88800 20000			357	352
40.000 1.5748	95.250 3.7500	27.783 1.0938	127000 28500	0.28	2.11	32900 7400	16000 3600	2.05	144000 32400			442-S	432
40.000 1.5748	107.950 4.2500	36.512 1.4375	172000 38700	0.30	2.02	44600 10000	22700 5090	1.97	206000 46200			543	532X
40.483 1.5938	82.550 3.2500	29.370 1.1563	103000 23100	0.55	1.10	26600 5980	24900 5590	1.07	130000 29300			HM801349	HM801310
40.987 1.6137	67.975 2.6762	17.500 0.6890	59100 13300	0.35	1.72	15300 3440	9140 2050	1.68	63500 14300			LM300849	LM300811
41.275 1.6250	67.975 2.6762	17.500 0.6890	49800 11200	0.35	1.72	12900 2900	7710 1730	1.68	63500 14300			LM300848	LM300811
41.275 1.6250	73.025 2.8750	16.667 0.6562	50800 11400	0.35	1.71	13200 2960	7890 1770	1.67	58100 13100			18590	18520
41.275 1.6250	73.431 2.8910	19.558 0.7700	74800 16800	0.40	1.50	19400 4360	13300 2980	1.46	74200 16700			LM501349	LM501310
41.275 1.6250	73.431 2.8910	19.558 0.7700	74800 16800	0.40	1.50	19400 4360	13300 2980	1.46	74200 16700			LM501349A	LM501310
41.275 1.6250	73.431 2.8910	21.430 0.8437	74800 16800	0.40	1.50	19400 4360	13300 2980	1.46	74200 16700			LM501349	LM501314
41.275 1.6250	73.431 2.8910	23.012 0.9060	74800 16800	0.40	1.50	19400 4360	13300 2980	1.46	74200 16700			LM501349	LM501311
41.275 1.6250	76.200 3.0000	18.009 0.7090	48100 10800	0.49	1.23	12500 2800	10400 2340	1.20	55100 12400			11163	11300
41.275 1.6250	76.200 3.0000	18.009 0.7090	48100 10800	0.49	1.23	12500 2800	10400 2340	1.20	55100 12400			11162	11300
41.275 1.6250	76.200 3.0000	22.225 0.8750	75500 17000	0.39	1.53	19600 4400	13200 2960	1.49	89200 20100			24780	24722
41.275 1.6250	76.200 3.0000	22.225 0.8750	75500 17000	0.39	1.53	19600 4400	13200 2960	1.49	89200 20100			24780	24720

⁽¹⁾Based on 1×10^6 revolutions L_{10} life, for the ISO life-calculation method.

⁽²⁾Consult your Timken engineer for instructions on use or review the Timken Engineering Manual on timken.com/catalogs.

⁽³⁾Based on 90×10^6 revolutions L_{10} life, for The Timken Company life-calculation method. C_{90} and C_{a90} are radial and thrust values.

Bearing Dimensions											Geometry Factors			Bearing Weight
Width B	Width C	Eff. Ctr. a ⁽⁴⁾	Shaft			Housing			Cage		G ₁	G ₂	C _g	
			Max Shaft Fillet Radius R ⁽⁵⁾	Backing Shoulder Dia. d _a	Shoulder Dia. d _b	Max Housing Fillet Radius r ⁽⁵⁾	Backing Shoulder Dia. D _a	Shoulder Dia. D _b	A _a ⁽⁶⁾	A _b ⁽⁷⁾				
mm in.	mm in.	mm in.	mm in.	mm in.	mm in.	mm in.	mm in.	mm in.	mm in.	mm in.				kg lbs.
21.692 0.8540	21.808 0.8586	-4.8 -0.19	4.0 0.16	46.5 1.83	54.0 2.13	2.3 0.09	82.0 3.23	78.0 3.07	0.4 0.01	1.7 0.07	30.0	12.2	0.0732	0.71 1.57
21.692 0.8540	21.808 0.8586	-4.8 -0.19	0.8 0.03	46.5 1.83	47.5 1.87	2.3 0.09	82.0 3.23	78.0 3.07	0.4 0.01	1.7 0.07	30.0	12.2	0.0732	0.72 1.59
21.692 0.8540	21.808 0.8586	-4.8 -0.19	2.3 0.09	46.5 1.83	51.0 2.01	2.3 0.09	82.0 3.23	78.0 3.07	0.4 0.01	1.7 0.07	30.0	12.2	0.0732	0.72 1.58
29.900 1.1772	22.225 0.8750	-9.1 -0.36	3.5 0.14	47.0 1.85	54.0 2.13	2.3 0.09	87.0 3.43	83.0 3.27	1.6 0.06	0.5 0.02	42.5	11.3	0.0805	1.00 2.21
36.957 1.4550	28.575 1.1250	-12.2 -0.48	3.5 0.14	50.0 1.97	57.0 2.24	3.3 0.13	100.0 3.94	94.0 3.70	2.7 0.10	1.0 0.04	64.3	16.1	0.0938	1.74 3.85
28.575 1.1250	23.020 0.9063	-4.8 -0.19	3.5 0.14	49.1 1.93	58.0 2.28	3.3 0.13	78.0 3.07	68.0 2.68	2.1 0.08	1.9 0.08	33.7	14.0	0.0928	0.72 1.60
18.000 0.7087	13.500 0.5315	-3.6 -0.14	3.5 0.14	45.5 1.79	52.0 2.05	1.5 0.06	65.0 2.56	61.0 2.40	0.6 0.02	1.3 0.05	22.5	18.1	0.0698	0.24 0.53
18.000 0.7087	13.500 0.5315	-3.6 -0.14	3.5 0.14	45.5 1.79	52.0 2.05	1.5 0.06	65.0 2.56	61.0 2.40	0.6 0.02	1.3 0.05	22.5	18.1	0.0698	0.24 0.53
17.462 0.6875	12.700 0.5000	-2.8 -0.11	3.5 0.14	46.0 1.81	53.0 2.09	1.5 0.06	69.0 2.72	66.0 2.60	0.4 0.01	1.3 0.05	21.0	16.8	0.0681	0.28 0.61
19.812 0.7800	14.732 0.5800	-3.3 -0.13	3.5 0.14	48.0 1.89	54.0 2.13	0.8 0.03	70.0 2.76	67.0 2.64	0.9 0.03	1.0 0.04	23.3	13.3	0.0739	0.34 0.74
19.812 0.7800	14.732 0.5800	-3.3 -0.13	0.8 0.03	46.5 1.83	47.0 1.85	0.8 0.03	70.0 2.76	67.0 2.64	1.0 0.04	1.0 0.04	23.3	13.3	0.0739	0.33 0.73
19.812 0.7800	16.604 0.6537	-3.3 -0.13	3.5 0.14	48.0 1.89	54.0 2.13	0.8 0.03	70.0 2.76	65.0 2.56	0.9 0.03	1.0 0.04	23.3	13.3	0.0739	0.36 0.78
19.812 0.7800	18.186 0.7160	-3.3 -0.13	3.5 0.14	48.0 1.89	54.0 2.13	2.3 0.09	70.0 2.76	64.0 2.52	0.9 0.03	1.0 0.04	23.3	13.3	0.0739	0.37 0.81
17.384 0.6844	14.288 0.5625	-0.8 -0.03	0.8 0.03	46.5 1.83	47.0 1.85	1.5 0.06	71.0 2.80	67.0 2.64	* *	* *	19.2	16.0	0.0735	0.34 0.74
17.384 0.6844	14.288 0.5625	-0.8 -0.03	1.5 0.06	46.5 1.83	49.0 1.93	1.5 0.06	71.0 2.80	67.0 2.64	1.6 0.06	1.6 0.06	19.2	16.0	0.0735	0.34 0.74
23.020 0.9063	17.462 0.6875	-4.8 -0.19	3.5 0.14	47.0 1.85	54.0 2.13	3.3 0.13	72.0 2.83	66.0 2.60	1.1 0.04	1.1 0.05	26.4	16.5	0.0767	0.42 0.92
23.020 0.9063	17.462 0.6875	-4.8 -0.19	3.5 0.14	47.0 1.85	54.0 2.13	0.8 0.03	72.0 2.83	68.0 2.68	1.1 0.04	1.1 0.05	26.4	16.5	0.0767	0.43 0.94

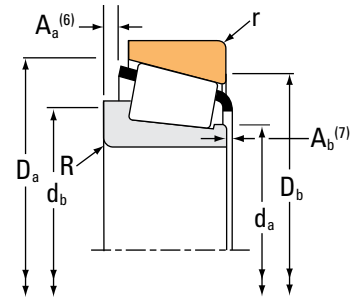
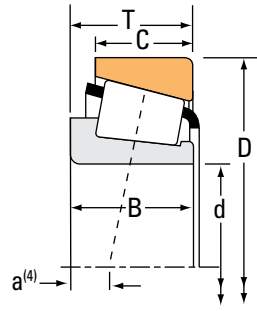
(4) Negative value indicates effective center inside cone (inner-ring) backface.
 (5) These maximum fillet radii will be cleared by the bearing corners.
 (6) Negative value indicates cage extends beyond cone (inner-ring) backface.
 (7) Negative value indicates cage that does not extend beyond cone (inner-ring) front face.
 (*) Contact your Timken engineer for details.

Continued on next page.

TAPERED ROLLER BEARINGS

SINGLE-ROW • TYPE TS

TYPE TS



Bearing Dimensions			Load Ratings							Part Number			
Bore d	O.D. D	Width T	Dynamic ⁽¹⁾		Factors ⁽²⁾		Dynamic ⁽³⁾		Factors ⁽²⁾		Static C ₀	Inner	Outer
			C ₁	e	Y	C ₉₀	C _{a90}	K	N	N			
mm in.	mm in.	mm in.	N lbf			N lbf	N lbf		N lbf				
41.275 1.6250	76.200 3.0000	22.225 0.8750	75500 17000	0.39	1.53	19600 4400	13200 2960	1.49	89200 20100		24781	24720	
41.275 1.6250	76.200 3.0000	25.400 1.0000	75500 17000	0.39	1.53	19600 4400	13200 2960	1.49	89200 20100		24780	24721	
41.275 1.6250	76.200 3.0000	25.400 1.0000	75500 17000	0.39	1.53	19600 4400	13200 2960	1.49	89200 20100		24781	24721	
41.275 1.6250	79.375 3.1250	23.812 0.9375	91100 20500	0.32	1.88	23600 5310	12900 2900	1.83	110000 24800		26882	26822	
41.275 1.6250	79.375 3.1250	23.812 0.9375	91100 20500	0.32	1.88	23600 5310	12900 2900	1.83	110000 24800		26885	26822	
41.275 1.6250	80.000 3.1496	18.009 0.7090	48100 10800	0.49	1.23	12500 2800	10400 2340	1.20	55100 12400		11162	11315	
41.275 1.6250	80.000 3.1496	21.000 0.8268	94300 21200	0.27	2.20	24400 5490	11400 2570	2.14	83400 18700		342	332	
41.275 1.6250	80.000 3.1496	21.000 0.8268	94300 21200	0.27	2.20	24400 5490	11400 2570	2.14	83400 18700		336	332	
41.275 1.6250	80.035 3.1510	29.370 1.1563	115000 25800	0.27	2.20	29800 6700	13900 3130	2.14	129000 29100		3383	3339	
41.275 1.6250	80.167 3.1562	25.400 1.0000	91100 20500	0.32	1.88	23600 5310	12900 2900	1.83	110000 24800		26882	26820	
41.275 1.6250	80.167 3.1562	26.988 1.0625	94300 21200	0.27	2.20	24400 5490	11400 2570	2.14	83400 18700		336	3320	
41.275 1.6250	80.167 3.1562	26.988 1.0625	94300 21200	0.27	2.20	24400 5490	11400 2570	2.14	83400 18700		342	3320	
41.275 1.6250	80.167 3.1562	29.370 1.1563	91100 20500	0.32	1.88	23600 5310	12900 2900	1.83	110000 24800		26882	26821	
41.275 1.6250	81.755 3.2187	29.370 1.1563	115000 25800	0.27	2.20	29800 6700	13900 3130	2.14	129000 29100		3383	3329	
41.275 1.6250	82.550 3.2500	26.195 1.0313	92900 20900	0.40	1.49	24100 5420	16600 3730	1.45	115000 25800		22778	22721	
41.275 1.6250	82.550 3.2500	26.543 1.0450	91700 20600	0.55	1.10	23800 5340	22200 4990	1.07	112000 25300		M802048	M802011	
41.275 1.6250	82.550 3.2500	26.543 1.0450	91700 20600	0.55	1.10	23800 5340	22200 4990	1.07	112000 25300		M802047	M802011	

⁽¹⁾Based on 1 x 10⁶ revolutions L₁₀ life, for the ISO life-calculation method.

⁽²⁾Consult your Timken engineer for instructions on use or review the Timken Engineering Manual on timken.com/catalogs.

⁽³⁾Based on 90 x 10⁶ revolutions L₁₀ life, for The Timken Company life-calculation method. C₉₀ and C_{a90} are radial and thrust values.

Bearing Dimensions											Geometry Factors			Bearing Weight
Width B	Width C	Eff. Ctr. a ⁽⁴⁾	Shaft			Housing			Cage		G ₁	G ₂	C _g	
			Max Shaft Fillet Radius R ⁽⁵⁾	Backing Shoulder Dia. d _a	Backing Shoulder Dia. d _b	Max Housing Fillet Radius r ⁽⁵⁾	Backing Shoulder Dia. D _a	Backing Shoulder Dia. D _b	A _a ⁽⁶⁾	A _b ⁽⁷⁾				
mm in.	mm in.	mm in.	mm in.	mm in.	mm in.	mm in.	mm in.	mm in.	mm in.	mm in.				kg lbs.
23.020 0.9063	17.462 0.6875	-4.8 -0.19	0.8 0.03	47.0 1.85	48.0 1.89	0.8 0.03	72.0 2.83	68.0 2.68	1.2 0.04	1.1 0.05	26.4	16.5	0.0767	0.43 0.95
23.020 0.9063	20.638 0.8125	-4.8 -0.19	3.5 0.14	47.0 1.85	54.0 2.13	2.3 0.09	72.0 2.83	66.0 2.60	1.1 0.04	1.1 0.05	26.4	16.5	0.0767	0.47 1.02
23.020 0.9063	20.638 0.8125	-4.8 -0.19	0.8 0.03	47.0 1.85	48.0 1.89	2.3 0.09	72.0 2.83	66.0 2.60	1.2 0.04	1.1 0.05	26.4	16.5	0.0767	0.47 1.03
25.400 1.0000	19.050 0.7500	-7.4 -0.29	3.5 0.14	47.0 1.85	54.0 2.13	0.8 0.03	74.0 2.91	71.0 2.80	1.4 0.05	1.3 0.05	32.8	13.3	0.0770	0.52 1.15
25.400 1.0000	19.050 0.7500	-7.4 -0.29	0.8 0.03	47.0 1.85	48.0 1.89	0.8 0.03	74.0 2.91	71.0 2.80	1.4 0.05	1.3 0.05	32.8	13.3	0.0770	0.52 1.17
17.384 0.6844	14.288 0.5625	-0.8 -0.03	1.5 0.06	46.5 1.83	49.0 1.93	1.5 0.06	73.0 2.87	69.0 2.72	1.6 0.06	1.6 0.06	19.2	16.0	0.0735	0.39 0.85
22.403 0.8820	17.826 0.7018	-6.4 -0.25	3.5 0.14	46.0 1.81	53.0 2.09	1.3 0.05	75.0 2.95	73.0 2.87	0.7 0.02	1.1 0.05	26.5	13.0	0.0676	0.45 1.01
22.403 0.8820	17.826 0.7018	-6.4 -0.25	0.8 0.03	46.0 1.81	47.0 1.85	1.3 0.05	75.0 2.95	73.0 2.87	0.7 0.02	1.1 0.05	26.5	13.0	0.0676	0.46 1.02
30.391 1.1965	23.812 0.9375	-10.9 -0.43	3.5 0.14	47.0 1.85	54.0 2.13	1.5 0.06	74.8 2.94	71.0 2.80	1.8 0.07	1.1 0.05	34.6	12.1	0.0744	0.62 1.39
25.400 1.0000	20.638 0.8125	-7.4 -0.29	3.5 0.14	47.0 1.85	54.0 2.13	3.3 0.13	74.0 2.91	69.0 2.72	1.4 0.05	1.3 0.05	32.8	13.3	0.0770	0.55 1.21
22.403 0.8820	23.812 0.9375	-6.4 -0.25	0.8 0.03	46.0 1.81	47.0 1.85	3.3 0.13	75.0 2.95	70.0 2.76	0.7 0.02	1.1 0.05	26.5	13.0	0.0676	0.53 1.17
22.403 0.8820	23.812 0.9375	-6.4 -0.25	3.5 0.14	46.0 1.81	53.0 2.09	3.3 0.13	75.0 2.95	70.0 2.76	0.7 0.02	1.1 0.05	26.5	13.0	0.0676	0.52 1.15
25.400 1.0000	24.608 0.9688	-7.4 -0.29	3.5 0.14	47.0 1.85	54.0 2.13	3.3 0.13	74.0 2.91	68.0 2.68	1.4 0.05	1.3 0.05	32.8	13.3	0.0770	0.61 1.35
30.391 1.1965	23.812 0.9375	-10.9 -0.43	3.5 0.14	47.0 1.85	54.0 2.13	3.3 0.13	75.0 2.95	71.0 2.80	1.8 0.07	1.1 0.05	34.6	12.1	0.0744	0.66 1.46
26.988 1.0625	20.638 0.8125	-6.4 -0.25	3.5 0.14	49.0 1.93	55.0 2.17	0.8 0.03	77.0 3.03	73.0 2.87	1.8 0.07	1.1 0.05	33.9	15.3	0.0841	0.64 1.40
25.654 1.0100	20.193 0.7950	-3.0 -0.12	3.5 0.14	50.6 1.99	57.0 2.24	3.3 0.13	79.0 3.11	70.0 2.76	2.2 0.09	1.7 0.07	30.9	11.9	0.0899	0.62 1.37
25.654 1.0100	20.193 0.7950	-3.0 -0.12	0.8 0.03	50.6 1.99	52.0 2.05	3.3 0.13	79.0 3.11	70.0 2.76	2.2 0.09	1.7 0.07	30.9	11.9	0.0899	0.63 1.39

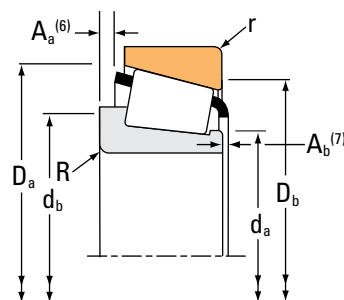
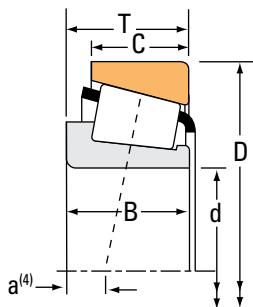
(4) Negative value indicates effective center inside cone (inner-ring) backface.
 (5) These maximum fillet radii will be cleared by the bearing corners.
 (6) Negative value indicates cage extends beyond cone (inner-ring) backface.
 (7) Negative value indicates cage that does not extend beyond cone (inner-ring) front face.

Continued on next page.

TAPERED ROLLER BEARINGS

SINGLE-ROW • TYPE TS

TYPE TS



Bearing Dimensions			Load Ratings							Part Number			
Bore d	O.D. D	Width T	Dynamic ⁽¹⁾		Factors ⁽²⁾		Dynamic ⁽³⁾		Factors ⁽²⁾		Static C ₀	Inner	Outer
			C ₁	e	Y	C ₉₀	C _{a90}	K	N	N			
mm in.	mm in.	mm in.	N lbf			N lbf	N lbf		N lbf		N lbf		
41.275 1.6250	84.138 3.3125	29.370 1.1563	115000 25800	0.27	2.20	29800 6700	13900 3130	2.14	129000 29100			3383	3328
41.275 1.6250	84.138 3.3125	30.162 1.1875	113000 25500	0.31	1.96	29400 6610	15400 3460	1.91	134000 30100			3576	3520
41.275 1.6250	84.138 3.3125	30.162 1.1875	113000 25500	0.31	1.96	29400 6610	15400 3460	1.91	134000 30100			3576	3530
41.275 1.6250	84.138 3.3125	30.162 1.1875	113000 25500	0.31	1.96	29400 6610	15400 3460	1.91	134000 30100			3577	3530
41.275 1.6250	85.725 3.3750	30.162 1.1875	124000 27900	0.40	1.49	32200 7240	22200 4980	1.45	148000 33200			3877	3820
41.275 1.6250	85.725 3.3750	30.162 1.1875	124000 27900	0.40	1.49	32200 7240	22200 4980	1.45	148000 33200			3880	3820
41.275 1.6250	85.725 3.3750	30.162 1.1875	124000 27900	0.40	1.49	32200 7240	22200 4980	1.45	148000 33200			3880	3821
41.275 1.6250	85.725 3.3750	30.162 1.1875	124000 27900	0.40	1.49	32200 7240	22200 4980	1.45	148000 33200			3877	3821
41.275 1.6250	85.725 3.3750	30.162 1.1875	124000 27900	0.40	1.49	32200 7240	22200 4980	1.45	148000 33200			3877A	3820
41.275 1.6250	87.312 3.4375	30.162 1.1875	113000 25500	0.31	1.96	29400 6610	15400 3460	1.91	134000 30100			3577	3525
41.275 1.6250	87.312 3.4375	30.162 1.1875	113000 25500	0.31	1.96	29400 6610	15400 3460	1.91	134000 30100			3576	3525
41.275 1.6250	87.312 3.4375	30.162 1.1875	113000 25500	0.31	1.96	29400 6610	15400 3460	1.91	134000 30100			3585	3525
41.275 1.6250	88.500 3.4843	25.400 1.0000	99800 22400	0.78	0.77	25900 5810	34600 7770	0.75	88600 19900			44162	44348
41.275 1.6250	88.500 3.4843	26.988 1.0625	116000 26000	0.26	2.28	30000 6740	13500 3040	2.22	124000 28000			419	414
41.275 1.6250	88.900 3.5000	20.638 0.8125	102000 22900	0.32	1.88	26400 5930	14400 3250	1.83	95800 21500			365A	362A
41.275 1.6250	88.900 3.5000	30.162 1.1875	114000 25600	0.55	1.10	29500 6630	27600 6200	1.07	144000 32400			HM803146	HM803110
41.275 1.6250	88.900 3.5000	30.162 1.1875	114000 25600	0.55	1.10	29500 6630	27600 6200	1.07	144000 32400			HM803145	HM803110

⁽¹⁾Based on 1 x 10⁶ revolutions L₁₀ life, for the ISO life-calculation method.

⁽²⁾Consult your Timken engineer for instructions on use or review the Timken Engineering Manual on timken.com/catalogs.

⁽³⁾Based on 90 x 10⁶ revolutions L₁₀ life, for The Timken Company life-calculation method. C₉₀ and C_{a90} are radial and thrust values.

Bearing Dimensions											Geometry Factors			Bearing Weight
Width B	Width C	Eff. Ctr. a ⁽⁴⁾	Shaft			Housing			Cage		G ₁	G ₂	C _g	
			Max Shaft Fillet Radius R ⁽⁵⁾	Backing Shoulder Dia. d _a	mm in.	Max Housing Fillet Radius r ⁽⁵⁾	Backing Shoulder Dia. D _a	mm in.	A _a ⁽⁶⁾	A _b ⁽⁷⁾				
mm in.	mm in.	mm in.	mm in.	mm in.	mm in.	mm in.	mm in.	mm in.	mm in.	mm in.			kg lbs.	
30.391 1.1965	23.812 0.9375	-10.9 -0.43	3.5 0.14	47.0 1.85	54.0 2.13	3.3 0.13	76.0 2.99	72.0 2.83	1.8 0.07	1.1 0.05	34.6	12.1	0.0744	0.71 1.58
30.886 1.2160	23.812 0.9375	-10.2 -0.40	0.8 0.03	48.0 1.89	49.0 1.93	3.3 0.13	79.5 3.13	74.0 2.91	2.2 0.09	0.7 0.03	39.5	12.5	0.0808	0.75 1.64
30.886 1.2160	23.812 0.9375	-10.2 -0.40	0.8 0.03	48.0 1.89	49.0 1.93	0.8 0.03	79.5 3.13	76.0 2.99	2.2 0.09	0.7 0.03	39.5	12.5	0.0808	0.76 1.66
30.886 1.2160	23.812 0.9375	-10.2 -0.40	3.5 0.14	48.0 1.89	54.0 2.13	0.8 0.03	79.5 3.13	76.0 2.99	2.2 0.09	0.7 0.03	39.5	12.5	0.0808	0.75 1.65
30.162 1.1875	23.812 0.9375	-8.1 -0.32	3.5 0.14	50.0 1.98	57.0 2.24	3.3 0.13	81.0 3.19	73.0 2.87	1.4 0.05	2.2 0.09	37.8	13.5	0.0873	0.80 1.76
30.162 1.1875	23.812 0.9375	-8.1 -0.32	0.8 0.03	50.0 1.98	52.0 2.05	3.3 0.13	81.0 3.19	73.0 2.87	1.4 0.05	2.2 0.09	37.8	13.5	0.0873	0.80 1.77
30.162 1.1875	23.812 0.9375	-8.1 -0.32	0.8 0.03	50.0 1.98	52.0 2.05	1.3 0.05	81.0 3.19	75.0 2.95	1.4 0.05	2.2 0.09	37.8	13.5	0.0873	0.81 1.79
30.162 1.1875	23.812 0.9375	-8.1 -0.32	3.5 0.14	50.0 1.98	57.0 2.24	1.3 0.05	81.0 3.19	75.0 2.95	1.4 0.05	2.2 0.09	37.8	13.5	0.0873	0.81 1.78
30.162 1.1875	23.812 0.9375	-8.1 -0.32	2.3 0.09	50.0 1.98	55.0 2.17	3.3 0.13	81.0 3.19	73.0 2.87	1.4 0.05	2.2 0.09	37.8	13.5	0.0873	0.80 1.76
30.886 1.2160	23.812 0.9375	-10.2 -0.40	3.5 0.14	48.0 1.89	54.0 2.13	3.3 0.13	81.0 3.19	75.0 2.95	2.2 0.09	0.7 0.03	39.5	12.5	0.0808	0.82 1.80
30.886 1.2160	23.812 0.9375	-10.2 -0.40	0.8 0.03	48.0 1.89	49.0 1.93	3.3 0.13	81.0 3.19	75.0 2.95	2.2 0.09	0.7 0.03	39.5	12.5	0.0808	0.83 1.81
30.886 1.2160	23.812 0.9375	-10.2 -0.40	1.5 0.06	48.0 1.89	50.0 1.97	3.3 0.13	81.0 3.19	75.0 2.95	2.2 0.09	0.7 0.03	39.5	12.5	0.0808	0.83 1.81
23.698 0.9330	17.462 0.6875	2.3 0.09	2.3 0.09	50.8 2.00	57.0 2.24	1.5 0.06	84.0 3.31	75.0 2.95	3.8 0.15	2.7 0.11	22.9	8.7	0.0899	0.67 1.48
29.083 1.1450	22.225 0.8750	-9.7 -0.38	3.5 0.14	47.0 1.85	54.0 2.13	1.5 0.06	80.0 3.15	77.0 3.03	1.2 0.04	0.8 0.03	34.4	9.9	0.0731	0.78 1.71
22.225 0.8750	16.513 0.6501	-4.3 -0.17	3.5 0.14	48.5 1.91	55.0 2.17	1.3 0.05	84.0 3.31	81.0 3.19	0.4 0.01	1.1 0.04	33.8	14.0	0.0773	0.63 1.38
29.370 1.1563	23.020 0.9063	-4.3 -0.17	3.5 0.14	53.0 2.09	60.0 2.36	3.3 0.13	85.0 3.35	74.0 2.91	1.5 0.05	2.2 0.09	39.2	10.6	0.0974	0.89 1.96
29.370 1.1563	23.020 0.9063	-4.3 -0.17	0.8 0.03	53.0 2.09	54.0 2.13	3.3 0.13	85.0 3.35	74.0 2.91	1.5 0.05	2.2 0.09	39.2	10.6	0.0974	0.89 1.98

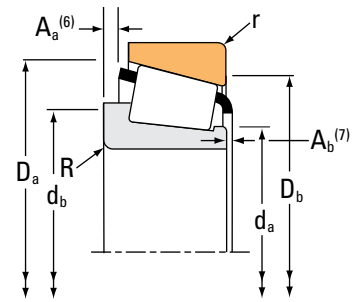
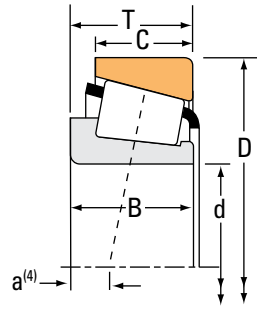
⁽⁴⁾Negative value indicates effective center inside cone (inner-ring) backface.
⁽⁵⁾These maximum fillet radii will be cleared by the bearing corners.
⁽⁶⁾Negative value indicates cage extends beyond cone (inner-ring) backface.
⁽⁷⁾Negative value indicates cage that does not extend beyond cone (inner-ring) front face.

Continued on next page.

TAPERED ROLLER BEARINGS

SINGLE-ROW • TYPE TS

TYPE TS



Bearing Dimensions			Load Ratings						Part Number				
Bore d	O.D. D	Width T	Dynamic ⁽¹⁾		Factors ⁽²⁾		Dynamic ⁽³⁾		Factors ⁽²⁾		Static C ₀	Inner	Outer
			C ₁	e	Y	C ₉₀	C _{a90}	K	N	N			
mm in.	mm in.	mm in.	N lbf			N lbf	N lbf		N lbf				
41.275 1.6250	90.000 3.5433	19.914 0.7874	102000 22900	0.32	1.88	26400 5930	14400 3250	1.83	95800 21500		365A	362	
41.275 1.6250	90.488 3.5625	39.688 1.5625	199000 44700	0.28	2.11	51500 11600	25100 5640	2.05	204000 45900		4388	4335	
41.275 1.6250	92.075 3.6250	26.195 1.0313	101000 22800	0.83	0.72	26300 5910	37400 8410	0.70	92500 20800		M903345	M903310	
41.275 1.6250	92.075 3.6250	30.162 1.1875	114000 25600	0.55	1.10	29500 6630	27600 6200	1.07	144000 32400		HM803146	HM803112	
41.275 1.6250	92.075 3.6250	30.162 1.1875	114000 25600	0.55	1.10	29500 6630	27600 6200	1.07	144000 32400		HM803145	HM803112	
41.275 1.6250	93.662 3.6875	31.750 1.2500	136000 30500	0.36	1.67	35200 7900	21700 4870	1.62	156000 35000		49162	49368	
41.275 1.6250	95.250 3.7500	27.783 1.0938	127000 28500	0.28	2.11	32900 7400	16000 3600	2.05	144000 32400		447	432	
41.275 1.6250	95.250 3.7500	30.162 1.1875	147000 33100	0.55	1.10	38200 8590	35700 8030	1.07	157000 35400		HM804840	HM804810	
41.275 1.6250	95.250 3.7500	30.958 1.2188	119000 26700	0.74	0.81	30800 6920	39000 8760	0.79	104000 23400		53162	53375	
41.275 1.6250	95.250 3.7500	30.958 1.2188	136000 30700	0.74	0.81	35400 7950	44800 10100	0.79	132000 29700		HM903245	HM903210	
41.275 1.6250	95.250 3.7500	30.958 1.2188	136000 30700	0.74	0.81	35400 7950	44800 10100	0.79	132000 29700		HM903244	HM903210	
41.275 1.6250	95.250 3.7500	31.753 1.2501	127000 28500	0.28	2.11	32900 7400	16000 3600	2.05	144000 32400		447	432X	
41.275 1.6250	98.425 3.8750	30.958 1.2188	119000 26700	0.74	0.81	30800 6920	39000 8760	0.79	104000 23400		53162	53387	
41.275 1.6250	98.425 3.8750	30.958 1.2188	136000 30700	0.74	0.81	35400 7950	44800 10100	0.79	132000 29700		HM903244	HM903216	
41.275 1.6250	101.600 4.0000	34.925 1.3750	165000 37000	0.29	2.10	42700 9600	20800 4690	2.05	191000 43000		526	522	
41.275 1.6250	104.775 4.1250	36.512 1.4375	172000 38600	0.49	1.23	44500 10000	37100 8350	1.20	223000 50200		HM807035	HM807010	
41.275 1.6250	107.950 4.2500	27.783 1.0938	136000 30500	0.34	1.79	35200 7900	20200 4540	1.74	166000 37200		464A	453A	

⁽¹⁾Based on 1 x 10⁶ revolutions L₁₀ life, for the ISO life-calculation method.

⁽²⁾Consult your Timken engineer for instructions on use or review the Timken Engineering Manual on timken.com/catalogs.

⁽³⁾Based on 90 x 10⁶ revolutions L₁₀ life, for The Timken Company life-calculation method. C₉₀ and C_{a90} are radial and thrust values.

Bearing Dimensions											Geometry Factors			Bearing Weight
Width B	Width C	Eff. Ctr. a ⁽⁴⁾	Shaft			Housing			Cage		G ₁	G ₂	C _g	
			Max Shaft Fillet Radius R ⁽⁵⁾	Backing Shoulder Dia. d _a	Shoulder Dia. d _b	Max Housing Fillet Radius r ⁽⁵⁾	Backing Shoulder Dia. D _a	Shoulder Dia. D _b	A _a ⁽⁶⁾	A _b ⁽⁷⁾				
mm in.	mm in.	mm in.	mm in.	mm in.	mm in.	mm in.	mm in.	mm in.	mm in.	mm in.				kg lbs.
22.225 0.8750	15.875 0.6250	-4.3 -0.17	3.5 0.14	48.5 1.91	55.0 2.17	2.0 0.08	84.0 3.31	81.0 3.19	0.4 0.01	1.1 0.04	33.8	14.0	0.0773	0.63 1.40
40.386 1.5900	33.338 1.3125	-15.0 -0.59	3.5 0.14	52.0 2.05	60.0 2.36	3.3 0.13	85.0 3.35	77.0 3.03	2.2 0.09	0.6 0.03	52.9	14.3	0.0872	1.24 2.74
23.812 0.9375	16.670 0.6563	3.6 0.14	3.5 0.14	54.0 2.13	65.0 2.56	1.5 0.06	88.0 3.46	78.0 3.07	4.8 0.19	3.4 0.14	25.6	13.1	0.0948	0.76 1.68
29.370 1.1563	23.020 0.9063	-4.3 -0.17	3.5 0.14	53.0 2.09	60.0 2.36	3.3 0.13	86.0 3.39	76.0 2.99	1.5 0.05	2.2 0.09	39.2	10.6	0.0974	0.97 2.14
29.370 1.1563	23.020 0.9063	-4.3 -0.17	0.8 0.03	53.0 2.09	54.0 2.13	3.3 0.13	86.0 3.39	76.0 2.99	1.5 0.05	2.2 0.09	39.2	10.6	0.0974	0.97 2.15
31.750 1.2500	25.400 1.0000	-9.1 -0.36	3.5 0.14	50.0 1.97	57.0 2.24	3.3 0.13	87.0 3.43	82.0 3.23	2.9 0.11	0.8 0.04	42.4	13.6	0.0872	1.03 2.27
29.900 1.1772	22.225 0.8750	-9.1 -0.36	3.5 0.14	48.5 1.91	55.0 2.17	2.3 0.09	87.0 3.43	83.0 3.27	1.6 0.06	0.5 0.02	42.5	11.3	0.0805	0.98 2.17
29.370 1.1563	23.020 0.9063	-3.8 -0.15	3.5 0.14	54.0 2.13	61.0 2.40	3.3 0.13	91.0 3.58	81.0 3.19	2.2 0.09	2.8 0.11	44.8	13.8	0.1017	1.07 2.36
28.300 1.1142	20.638 0.8125	-0.3 -0.01	1.5 0.06	52.7 2.07	57.0 2.24	0.8 0.03	89.0 3.50	81.0 3.19	5.7 0.22	2.2 0.09	26.7	9.6	0.0930	0.97 2.15
28.575 1.1250	22.225 0.8750	0.5 0.02	3.5 0.14	54.0 2.13	63.0 2.48	0.8 0.03	91.0 3.58	81.0 3.19	3.9 0.15	2.1 0.08	33.7	12.4	0.1010	1.04 2.30
28.300 1.1142	22.225 0.8750	0.5 0.02	1.5 0.06	54.0 2.13	59.0 2.32	0.8 0.03	91.0 3.58	81.0 3.19	3.9 0.15	2.3 0.09	33.7	12.4	0.1010	1.04 2.30
29.900 1.1772	26.195 1.0313	-9.1 -0.36	3.5 0.14	48.5 1.91	55.0 2.17	3.3 0.13	87.0 3.43	81.0 3.19	1.6 0.06	0.5 0.02	42.5	11.3	0.0805	1.06 2.35
28.300 1.1142	20.638 0.8125	-0.3 -0.01	1.5 0.06	52.7 2.07	57.0 2.24	0.8 0.03	91.0 3.58	82.0 3.23	5.7 0.22	2.2 0.09	26.7	9.6	0.0930	1.05 2.33
28.300 1.1142	22.225 0.8750	0.5 0.02	1.5 0.06	54.0 2.13	59.0 2.32	0.8 0.03	92.0 3.62	82.0 3.23	3.9 0.15	2.3 0.09	33.7	12.4	0.1010	1.13 2.48
36.068 1.4200	26.988 1.0625	-12.7 -0.50	3.5 0.14	50.0 1.97	57.0 2.24	3.3 0.13	95.0 3.74	89.0 3.50	2.7 0.10	1.8 0.07	57.9	13.4	0.0894	1.42 3.14
36.512 1.4375	28.575 1.1250	-7.4 -0.29	1.5 0.06	57.0 2.24	60.0 2.36	3.3 0.13	100.0 3.94	89.0 3.50	3.4 0.13	2.0 0.08	63.9	17.1	0.0760	1.66 3.66
29.317 1.1542	22.225 0.8750	-7.1 -0.28	1.5 0.06	52.0 2.05	54.0 2.13	0.8 0.03	100.0 3.94	97.0 3.82	2.1 0.08	1.4 0.06	58.6	17.1	0.0946	1.39 3.05

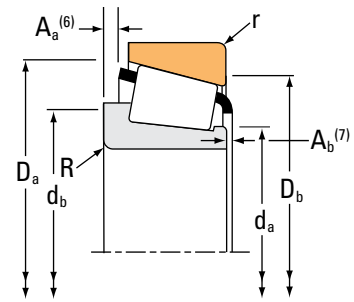
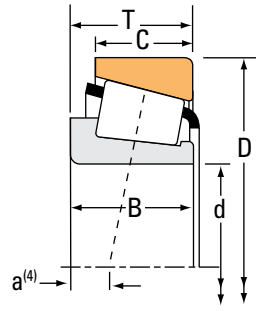
(4) Negative value indicates effective center inside cone (inner-ring) backface.
 (5) These maximum fillet radii will be cleared by the bearing corners.
 (6) Negative value indicates cage extends beyond cone (inner-ring) backface.
 (7) Negative value indicates cage that does not extend beyond cone (inner-ring) front face.

Continued on next page.

TAPERED ROLLER BEARINGS

SINGLE-ROW • TYPE TS

TYPE TS



Bearing Dimensions			Load Ratings							Part Number			
Bore d	O.D. D	Width T	Dynamic ⁽¹⁾		Factors ⁽²⁾		Dynamic ⁽³⁾		Factors ⁽²⁾		Static C ₀	Inner	Outer
			C ₁	e	Y	C ₉₀	C _{a90}	K	N	N			
mm in.	mm in.	mm in.	N lbf			N lbf	N lbf		N lbf				
41.275 1.6250	107.950 4.2500	27.783 1.0938	136000 30500	0.34	1.79	35200 7900	20200 4540	1.74	166000 37200		464	453A	
41.275 1.6250	107.950 4.2500	36.512 1.4375	172000 38700	0.30	2.02	44600 10000	22700 5090	1.97	206000 46200		541	532X	
42.000 1.6535	80.000 3.1496	18.009 0.7090	48100 10800	0.49	1.23	12500 2800	10400 2340	1.20	55100 12400		11165X	11315	
42.850 1.6870	104.775 4.1250	30.162 1.1875	136000 30500	0.34	1.79	35200 7900	20200 4540	1.74	166000 37200		461	453X	
42.850 1.6870	107.950 4.2500	27.795 1.0943	136000 30500	0.34	1.79	35200 7900	20200 4540	1.74	166000 37200		461	453	
42.850 1.6870	110.000 4.3307	27.795 1.0943	136000 30500	0.34	1.79	35200 7900	20200 4540	1.74	166000 37200		461	454	
42.862 1.6875	76.992 3.0312	17.462 0.6875	49500 11100	0.51	1.19	12800 2890	11100 2500	1.15	58100 13100		12168	12303	
42.862 1.6875	82.550 3.2500	19.842 0.7812	77400 17400	0.43	1.39	20100 4510	14800 3320	1.36	73200 16500		22168	22325	
42.862 1.6875	82.550 3.2500	26.195 1.0313	92900 20900	0.40	1.49	24100 5420	16600 3730	1.45	115000 25800		22780	22720	
42.862 1.6875	82.931 3.2650	23.812 0.9375	90500 20300	0.33	1.79	23500 5270	13500 3020	1.74	111000 24900		25578	25520	
42.862 1.6875	82.931 3.2650	26.988 1.0625	90500 20300	0.33	1.79	23500 5270	13500 3020	1.74	111000 24900		25578	25523	
42.862 1.6875	83.058 3.2700	23.812 0.9375	90500 20300	0.33	1.79	23500 5270	13500 3020	1.74	111000 24900		25576	25521	
42.862 1.6875	83.058 3.2700	23.876 0.9400	90500 20300	0.33	1.79	23500 5270	13500 3020	1.74	111000 24900		25578	25522	
42.862 1.6875	87.312 3.4375	30.162 1.1875	113000 25500	0.31	1.96	29400 6610	15400 3460	1.91	134000 30100		3579	3525	
42.862 1.6875	114.300 4.5000	44.450 1.7500	224000 50300	0.43	1.39	58000 13000	42700 9600	1.36	256000 57500		65383	65320	
42.875 1.6880	76.200 3.0000	25.400 1.0000	91100 20500	0.32	1.88	23600 5310	12900 2900	1.83	110000 24800		26884	26823	
42.875 1.6880	79.375 3.1250	23.812 0.9375	91100 20500	0.32	1.88	23600 5310	12900 2900	1.83	110000 24800		26884	26822	

⁽¹⁾Based on 1 x 10⁶ revolutions L₁₀ life, for the ISO life-calculation method.

⁽²⁾Consult your Timken engineer for instructions on use or review the Timken Engineering Manual on timken.com/catalogs.

⁽³⁾Based on 90 x 10⁶ revolutions L₁₀ life, for The Timken Company life-calculation method. C₉₀ and C_{a90} are radial and thrust values.

Bearing Dimensions											Geometry Factors			Bearing Weight
Width B	Width C	Eff. Ctr. a ⁽⁴⁾	Shaft			Housing			Cage		G ₁	G ₂	C _g	
			Max Shaft Fillet Radius R ⁽⁵⁾	Backing Shoulder Dia. d _a	Shoulder Dia. d _b	Max Housing Fillet Radius r ⁽⁵⁾	Backing Shoulder Dia. D _a	Shoulder Dia. D _b	A _a ⁽⁶⁾	A _b ⁽⁷⁾				
mm in.	mm in.	mm in.	mm in.	mm in.	mm in.	mm in.	mm in.	mm in.	mm in.	mm in.				kg lbs.
29.317 1.1542	22.225 0.8750	-7.1 -0.28	2.3 0.09	52.0 2.05	56.0 2.20	0.8 0.03	100.0 3.94	97.0 3.82	2.1 0.08	1.4 0.06	58.6	17.1	0.0946	1.38 3.05
36.957 1.4550	28.575 1.1250	-12.2 -0.48	3.5 0.14	51.0 2.01	58.0 2.28	3.3 0.13	100.0 3.94	94.0 3.70	2.7 0.10	1.0 0.04	64.3	16.1	0.0938	1.72 3.80
17.384 0.6844	14.288 0.5625	-0.8 -0.03	1.8 0.07	47.0 1.85	50.0 1.97	1.5 0.06	73.0 2.87	69.0 2.72	* *	* *	19.2	16.0	0.0735	0.38 0.83
29.317 1.1542	24.605 0.9687	-7.1 -0.28	0.8 0.03	53.0 2.09	54.0 2.13	3.3 0.13	98.0 3.86	92.0 3.62	2.1 0.08	1.4 0.06	58.6	17.1	0.0946	1.31 2.88
29.317 1.1542	27.000 1.0630	-7.1 -0.28	0.8 0.03	53.0 2.09	54.0 2.13	0.8 0.03	100.0 3.94	97.0 3.82	2.1 0.08	1.4 0.06	58.6	17.1	0.0946	1.42 3.12
29.317 1.1542	27.000 1.0630	-7.1 -0.28	0.8 0.03	53.0 2.09	54.0 2.13	2.0 0.08	100.0 3.94	96.0 3.78	2.1 0.08	1.4 0.06	58.6	17.1	0.0946	1.49 3.28
17.145 0.6750	11.908 0.4688	0.0 0.00	1.5 0.06	48.5 1.91	51.0 2.01	1.5 0.06	73.0 2.87	68.0 2.68	1.4 0.05	2.2 0.09	21.0	17.5	0.0766	0.33 0.71
19.837 0.7810	15.080 0.5937	-2.5 -0.10	2.3 0.09	48.5 1.91	52.0 2.05	1.5 0.06	76.0 2.99	73.0 2.87	1.1 0.04	1.8 0.07	23.7	14.4	0.0758	0.44 0.98
26.988 1.0625	20.638 0.8125	-6.4 -0.25	3.5 0.14	50.0 1.97	56.0 2.20	3.3 0.13	77.0 3.03	71.0 2.80	1.8 0.07	1.1 0.05	33.9	15.3	0.0841	0.60 1.32
25.400 1.0000	19.050 0.7500	-6.4 -0.25	2.3 0.09	49.5 1.95	53.0 2.09	0.8 0.03	77.0 3.03	74.0 2.91	1.0 0.04	0.7 0.03	35.2	14.3	0.0801	0.58 1.28
25.400 1.0000	22.225 0.8750	-6.4 -0.25	2.3 0.09	49.5 1.95	53.0 2.09	2.3 0.09	77.0 3.03	72.0 2.83	1.0 0.04	0.7 0.03	35.2	14.3	0.0801	0.62 1.37
25.400 1.0000	19.050 0.7500	-6.4 -0.25	3.5 0.14	49.0 1.93	55.0 2.17	3.3 0.13	77.0 3.03	72.0 2.83	1.0 0.04	0.7 0.03	35.2	14.3	0.0801	0.57 1.26
25.400 1.0000	19.114 0.7525	-6.4 -0.25	2.3 0.09	49.5 1.95	53.0 2.09	2.0 0.08	77.0 3.03	73.0 2.87	1.0 0.04	0.7 0.03	35.2	14.3	0.0801	0.58 1.29
30.886 1.2160	23.812 0.9375	-10.2 -0.40	3.5 0.14	49.5 1.95	56.0 2.20	3.3 0.13	81.0 3.19	75.0 2.95	2.2 0.09	0.7 0.03	39.5	12.5	0.0808	0.80 1.74
44.450 1.7500	34.925 1.3750	-12.4 -0.49	2.0 0.08	60.0 2.36	63.0 2.48	3.3 0.13	107.0 4.21	97.0 3.82	3.6 0.14	1.1 0.05	63.1	13.0	0.1053	2.35 5.19
25.400 1.0000	20.638 0.8125	-7.4 -0.29	3.5 0.14	48.5 1.91	55.0 2.17	1.5 0.06	73.0 2.87	69.0 2.72	1.4 0.05	1.3 0.05	32.8	13.3	0.0770	0.46 1.01
25.400 1.0000	19.050 0.7500	-7.4 -0.29	3.5 0.14	48.5 1.91	55.0 2.17	0.8 0.03	74.0 2.91	71.0 2.80	1.4 0.05	1.3 0.05	32.8	13.3	0.0770	0.50 1.11

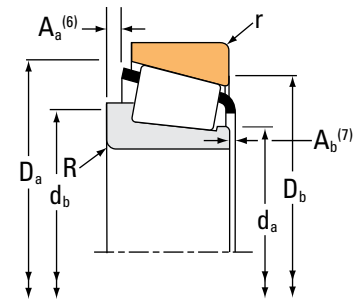
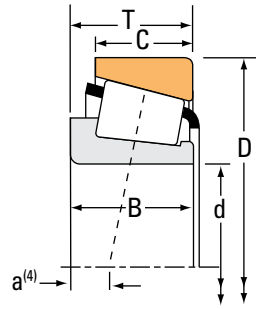
(4) Negative value indicates effective center inside cone (inner-ring) backface.
 (5) These maximum fillet radii will be cleared by the bearing corners.
 (6) Negative value indicates cage extends beyond cone (inner-ring) backface.
 (7) Negative value indicates cage that does not extend beyond cone (inner-ring) front face.
 (*) Contact your Timken engineer for details.

Continued on next page.

TAPERED ROLLER BEARINGS

SINGLE-ROW • TYPE TS

TYPE TS



Bearing Dimensions			Load Ratings							Part Number		
Bore d	O.D. D	Width T	Dynamic ⁽¹⁾		Factors ⁽²⁾		Dynamic ⁽³⁾		Factors ⁽²⁾	Static	Inner	Outer
			C ₁	e	Y	C ₉₀	C _{a90}	K	C ₀			
mm in.	mm in.	mm in.	N lbf			N lbf	N lbf		N lbf			
42.875 1.6880	80.000 3.1496	21.000 0.8268	94300 21200	0.27	2.20	24400 5490	11400 2570	2.14	83400 18700		342-S	332
42.875 1.6880	80.000 3.1496	23.812 0.9375	91100 20500	0.32	1.88	23600 5310	12900 2900	1.83	110000 24800		26884	26824
42.875 1.6880	80.000 3.1496	24.176 0.9518	94300 21200	0.27	2.20	24400 5490	11400 2570	2.14	83400 18700		342-S	332A
42.875 1.6880	80.167 3.1562	25.400 1.0000	91100 20500	0.32	1.88	23600 5310	12900 2900	1.83	110000 24800		26886	26830
42.875 1.6880	80.167 3.1562	25.400 1.0000	91100 20500	0.32	1.88	23600 5310	12900 2900	1.83	110000 24800		26886	26820
42.875 1.6880	81.973 3.2273	23.876 0.9400	90500 20300	0.33	1.79	23500 5270	13500 3020	1.74	111000 24900		25577	25518
42.875 1.6880	82.550 3.2500	23.812 0.9375	90500 20300	0.33	1.79	23500 5270	13500 3020	1.74	111000 24900		25577	25519
42.875 1.6880	82.931 3.2650	23.812 0.9375	90500 20300	0.33	1.79	23500 5270	13500 3020	1.74	111000 24900		25577	25520
42.875 1.6880	82.931 3.2650	26.988 1.0625	90500 20300	0.33	1.79	23500 5270	13500 3020	1.74	111000 24900		25577	25523
42.875 1.6880	83.058 3.2700	23.876 0.9400	90500 20300	0.33	1.79	23500 5270	13500 3020	1.74	111000 24900		25577	25522
42.987 1.6924	74.988 2.9523	19.368 0.7625	59500 13400	0.44	1.35	15400 3470	11700 2640	1.31	73500 16500		16986	16929
42.987 1.6924	79.375 3.1250	20.638 0.8125	68900 15500	0.37	1.64	17900 4020	11200 2510	1.60	83300 18700		17886	17830
42.987 1.6924	79.985 3.1490	19.842 0.7812	68900 15500	0.37	1.64	17900 4020	11200 2510	1.60	83300 18700		17886	17831
44.450 1.7500	71.438 2.8125	12.700 0.5000	36100 8110	0.31	1.97	9350 2100	4890 1100	1.91	43600 9790		LL103049	LL103010
44.450 1.7500	73.025 2.8750	18.258 0.7188	57000 12800	0.32	1.88	14800 3320	8060 1810	1.83	78300 17600		L102849	L102810
44.450 1.7500	76.992 3.0312	17.462 0.6875	49500 11100	0.51	1.19	12800 2890	11100 2500	1.15	58100 13100		12175	12303
44.450 1.7500	79.375 3.1250	17.462 0.6875	52000 11700	0.37	1.60	13500 3030	8630 1940	1.56	61300 13800		18685	18620

⁽¹⁾Based on 1 x 10⁶ revolutions L₁₀ life, for the ISO life-calculation method.

⁽²⁾Consult your Timken engineer for instructions on use or review the Timken Engineering Manual on timken.com/catalogs.

⁽³⁾Based on 90 x 10⁶ revolutions L₁₀ life, for The Timken Company life-calculation method. C₉₀ and C_{a90} are radial and thrust values.

Bearing Dimensions											Geometry Factors			Bearing Weight
Width B	Width C	Eff. Ctr. a ⁽⁴⁾	Shaft			Housing			Cage		G ₁	G ₂	C _g	
			Max Shaft Fillet Radius R ⁽⁵⁾	Backing Shoulder Dia. d _a	Backing Shoulder Dia. d _b	Max Housing Fillet Radius r ⁽⁵⁾	Backing Shoulder Dia. D _a	Backing Shoulder Dia. D _b	A _a ⁽⁶⁾	A _b ⁽⁷⁾				
mm in.	mm in.	mm in.	mm in.	mm in.	mm in.	mm in.	mm in.	mm in.	mm in.	mm in.				kg lbs.
22.403 0.8820	17.826 0.7018	-6.4 -0.25	3.5 0.14	47.5 1.87	54.0 2.13	1.3 0.05	75.0 2.95	73.0 2.87	0.7 0.02	1.1 0.05	26.5	13.0	0.0676	0.43 0.97
25.400 1.0000	19.050 0.7500	-7.4 -0.29	3.5 0.14	48.5 1.91	55.0 2.17	1.3 0.05	74.0 2.91	70.0 2.76	1.4 0.05	1.3 0.05	32.8	13.3	0.0770	0.52 1.13
22.403 0.8820	21.000 0.8268	-6.4 -0.25	3.5 0.14	47.5 1.87	54.0 2.13	2.3 0.09	75.0 2.95	71.0 2.80	0.7 0.02	1.1 0.05	26.5	13.0	0.0676	0.47 1.05
25.400 1.0000	20.638 0.8125	-7.4 -0.29	1.5 0.06	48.5 1.91	51.0 2.01	0.8 0.03	74.0 2.91	71.0 2.80	1.4 0.05	1.3 0.05	32.8	13.3	0.0770	0.54 1.20
25.400 1.0000	20.638 0.8125	-7.4 -0.29	1.5 0.06	48.5 1.91	51.0 2.01	3.3 0.13	74.0 2.91	69.0 2.72	1.4 0.05	1.3 0.05	32.8	13.3	0.0770	0.53 1.18
25.400 1.0000	19.114 0.7525	-6.4 -0.25	3.5 0.14	49.0 1.93	55.0 2.17	1.0 0.04	77.0 3.03	74.0 2.91	1.0 0.04	0.7 0.03	35.2	14.3	0.0801	0.56 1.23
25.400 1.0000	19.050 0.7500	-6.4 -0.25	3.5 0.14	49.0 1.93	55.0 2.17	2.0 0.08	77.0 3.03	73.0 2.87	1.0 0.04	0.7 0.03	35.2	14.3	0.0801	0.57 1.25
25.400 1.0000	19.050 0.7500	-6.4 -0.25	3.5 0.14	49.0 1.93	55.0 2.17	0.8 0.03	77.0 3.03	74.0 2.91	1.0 0.04	0.7 0.03	35.2	14.3	0.0801	0.58 1.27
25.400 1.0000	22.225 0.8750	-6.4 -0.25	3.5 0.14	49.0 1.93	55.0 2.17	2.3 0.09	77.0 3.03	72.0 2.83	1.0 0.04	0.7 0.03	35.2	14.3	0.0801	0.62 1.37
25.400 1.0000	19.114 0.7525	-6.4 -0.25	3.5 0.14	49.0 1.93	55.0 2.17	2.0 0.08	77.0 3.03	73.0 2.87	1.0 0.04	0.7 0.03	35.2	14.3	0.0801	0.58 1.28
19.837 0.7810	14.288 0.5625	-2.0 -0.08	1.5 0.06	48.5 1.91	51.0 2.01	1.3 0.05	71.0 2.80	68.0 2.68	* *	* *	25.1	17.4	0.0783	0.36 0.79
20.638 0.8125	15.875 0.6250	-3.8 -0.15	1.5 0.06	49.0 1.93	51.0 2.01	2.0 0.08	75.0 2.95	71.0 2.80	1.1 0.04	1.3 0.06	28.9	17.9	0.0770	0.42 0.94
20.638 0.8125	15.080 0.5937	-3.8 -0.15	1.5 0.06	49.0 1.93	51.0 2.01	1.3 0.05	75.0 2.95	72.0 2.83	1.1 0.04	1.3 0.06	28.9	17.9	0.0770	0.42 0.94
12.700 0.5000	9.525 0.3750	-1.3 -0.05	1.5 0.06	48.5 1.91	51.0 2.01	1.5 0.06	68.0 2.68	65.0 2.56	0.0 0.00	1.6 0.07	20.0	23.6	0.0637	0.18 0.39
18.258 0.7188	15.083 0.5938	-3.8 -0.15	1.5 0.06	49.0 1.93	51.0 2.01	1.5 0.06	69.0 2.72	66.0 2.60	0.0 0.00	1.8 0.07	30.6	25.9	0.0751	0.29 0.65
17.145 0.6750	11.908 0.4688	0.0 0.00	1.5 0.06	49.5 1.95	52.0 2.05	1.5 0.06	73.0 2.87	68.0 2.68	1.4 0.05	2.2 0.09	21.0	17.5	0.0766	0.31 0.68
17.462 0.6875	13.495 0.5313	-2.0 -0.08	2.8 0.11	49.5 1.95	54.0 2.13	1.5 0.06	74.0 2.91	71.0 2.80	0.7 0.02	1.6 0.07	23.9	18.7	0.0725	0.34 0.76

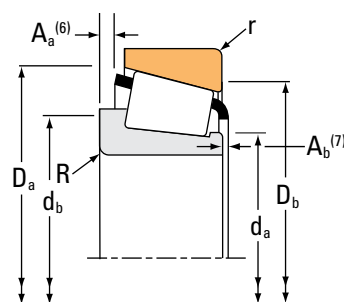
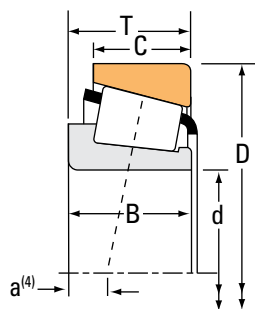
(4) Negative value indicates effective center inside cone (inner-ring) backface.
 (5) These maximum fillet radii will be cleared by the bearing corners.
 (6) Negative value indicates cage extends beyond cone (inner-ring) backface.
 (7) Negative value indicates cage that does not extend beyond cone (inner-ring) front face.
 (*) Contact your Timken engineer for details.

Continued on next page.

TAPERED ROLLER BEARINGS

SINGLE-ROW • TYPE TS

TYPE TS



Bearing Dimensions			Load Ratings						Part Number			
Bore d	O.D. D	Width T	Dynamic ⁽¹⁾		Factors ⁽²⁾		Dynamic ⁽³⁾		Static		Inner	Outer
			C ₁	e	Y	C ₉₀	C _{a90}	K	C ₀			
mm in.	mm in.	mm in.	N lbf			N lbf	N lbf		N lbf			
44.450 1.7500	80.962 3.1875	19.050 0.7500	50800 11400	0.53	1.14	13200 2960	11900 2680	1.11	61100 13700		13175	13318
44.450 1.7500	82.550 3.2500	23.812 0.9375	90500 20300	0.33	1.79	23500 5270	13500 3020	1.74	111000 24900		25580	25519
44.450 1.7500	82.550 3.2500	23.812 0.9375	90500 20300	0.33	1.79	23500 5270	13500 3020	1.74	111000 24900		25582	25519
44.450 1.7500	82.550 3.2500	34.290 1.3500	90500 20300	0.33	1.79	23500 5270	13500 3020	1.74	111000 24900		25583	25519
44.450 1.7500	82.931 3.2650	22.225 0.8750	82800 18600	0.30	2.02	21500 4820	10900 2460	1.96	89200 20100		35175	35326
44.450 1.7500	82.931 3.2650	22.225 0.8750	98100 22100	0.30	2.02	25400 5720	13000 2910	1.96	89200 20100		35176	35326
44.450 1.7500	82.931 3.2650	23.812 0.9375	90500 20300	0.33	1.79	23500 5270	13500 3020	1.74	111000 24900		25580	25520
44.450 1.7500	82.931 3.2650	23.812 0.9375	90500 20300	0.33	1.79	23500 5270	13500 3020	1.74	111000 24900		25581	25520
44.450 1.7500	82.931 3.2650	23.812 0.9375	90500 20300	0.33	1.79	23500 5270	13500 3020	1.74	111000 24900		25580	25524
44.450 1.7500	82.931 3.2650	23.812 0.9375	90500 20300	0.33	1.79	23500 5270	13500 3020	1.74	111000 24900		25582	25520
44.450 1.7500	82.931 3.2650	26.988 1.0625	90500 20300	0.33	1.79	23500 5270	13500 3020	1.74	111000 24900		25580	25523
44.450 1.7500	82.931 3.2650	34.290 1.3500	90500 20300	0.33	1.79	23500 5270	13500 3020	1.74	111000 24900		25583	25524
44.450 1.7500	82.931 3.2650	34.290 1.3500	90500 20300	0.33	1.79	23500 5270	13500 3020	1.74	111000 24900		25583	25520
44.450 1.7500	83.058 3.2700	23.812 0.9375	90500 20300	0.33	1.79	23500 5270	13500 3020	1.74	111000 24900		25580	25521
44.450 1.7500	83.058 3.2700	23.812 0.9375	90500 20300	0.33	1.79	23500 5270	13500 3020	1.74	111000 24900		25581	25521
44.450 1.7500	83.058 3.2700	23.812 0.9375	90500 20300	0.33	1.79	23500 5270	13500 3020	1.74	111000 24900		25582	25521
44.450 1.7500	83.058 3.2700	23.876 0.9400	90500 20300	0.33	1.79	23500 5270	13500 3020	1.74	111000 24900		25580	25522

⁽¹⁾Based on 1×10^6 revolutions L_{10} life, for the ISO life-calculation method.

⁽²⁾Consult your Timken engineer for instructions on use or review the Timken Engineering Manual on timken.com/catalogs.

⁽³⁾Based on 90×10^6 revolutions L_{10} life, for The Timken Company life-calculation method. C_{90} and C_{a90} are radial and thrust values.

Bearing Dimensions											Geometry Factors			Bearing Weight
Width B	Width C	Eff. Ctr. a ⁽⁴⁾	Shaft			Housing			Cage		G ₁	G ₂	C _g	
			Max Shaft Fillet Radius R ⁽⁵⁾	Backing Shoulder Dia. d _a d _b		Max Housing Fillet Radius r ⁽⁵⁾	Backing Shoulder Dia. D _a D _b		A _a ⁽⁶⁾	A _b ⁽⁷⁾				
mm in.	mm in.	mm in.	mm in.	mm in.	mm in.	mm in.	mm in.	mm in.	mm in.	mm in.				kg lbs.
17.462 0.6875	14.288 0.5625	0.8 0.03	0.1 0.01	50.0 1.97	50.0 1.97	1.5 0.06	76.0 2.99	72.0 2.83	1.6 0.06	2.0 0.08	23.0	19.2	0.0799	0.39 0.86
25.400 1.0000	19.050 0.7500	-6.4 -0.25	3.5 0.14	50.0 1.97	57.0 2.24	2.0 0.08	77.0 3.03	73.0 2.87	0.9 0.03	0.8 0.03	35.2	14.3	0.0801	0.55 1.20
25.400 1.0000	19.050 0.7500	-6.4 -0.25	5.0 0.20	50.0 1.97	60.0 2.36	2.0 0.08	77.0 3.03	73.0 2.87	1.0 0.04	0.7 0.03	35.2	14.3	0.0801	0.54 1.18
35.878 1.4125	19.050 0.7500	-16.8 -0.66	0.0 0.00	50.0 1.97	65.0 2.56	2.0 0.08	77.0 3.03	73.0 2.87	11.4 0.45	0.7 0.03	35.2	14.3	0.0801	0.67 1.46
23.012 0.9060	17.462 0.6875	-6.1 -0.24	3.5 0.14	49.5 1.95	56.0 2.20	0.8 0.03	78.0 3.07	76.0 2.99	1.1 0.04	1.2 0.05	29.1	12.0	0.0718	0.49 1.07
23.012 0.9060	17.462 0.6875	-6.1 -0.24	0.8 0.03	49.5 1.95	50.0 1.97	0.8 0.03	78.0 3.07	76.0 2.99	1.1 0.04	1.2 0.05	29.1	12.0	0.0718	0.50 1.09
25.400 1.0000	19.050 0.7500	-6.4 -0.25	3.5 0.14	50.0 1.97	57.0 2.24	0.8 0.03	77.0 3.03	74.0 2.91	0.9 0.03	0.8 0.03	35.2	14.3	0.0801	0.56 1.22
25.400 1.0000	19.050 0.7500	-6.4 -0.25	0.5 0.02	50.0 1.97	51.0 2.01	0.8 0.03	77.0 3.03	74.0 2.91	1.0 0.04	0.7 0.03	35.2	14.3	0.0801	0.56 1.24
25.400 1.0000	19.050 0.7500	-6.4 -0.25	3.5 0.14	50.0 1.97	57.0 2.24	2.3 0.09	77.0 3.03	73.0 2.87	0.9 0.03	0.8 0.03	35.2	14.3	0.0801	0.56 1.21
25.400 1.0000	19.050 0.7500	-6.4 -0.25	5.0 0.20	50.0 1.97	60.0 2.36	0.8 0.03	77.0 3.03	74.0 2.91	1.0 0.04	0.7 0.03	35.2	14.3	0.0801	0.55 1.21
25.400 1.0000	22.225 0.8750	-6.4 -0.25	3.5 0.14	50.0 1.97	57.0 2.24	2.3 0.09	77.0 3.03	72.0 2.83	0.9 0.03	0.8 0.03	35.2	14.3	0.0801	0.60 1.32
35.878 1.4125	19.050 0.7500	-16.8 -0.66	0.0 0.00	50.0 1.97	65.0 2.56	2.3 0.09	77.0 3.03	73.0 2.87	11.4 0.45	0.7 0.03	35.2	14.3	0.0801	0.68 1.48
35.878 1.4125	19.050 0.7500	-16.8 -0.66	0.0 0.00	50.0 1.97	65.0 2.56	0.8 0.03	77.0 3.03	74.0 2.91	11.4 0.45	0.7 0.03	35.2	14.3	0.0801	0.68 1.49
25.400 1.0000	19.050 0.7500	-6.4 -0.25	3.5 0.14	50.0 1.97	57.0 2.24	3.3 0.13	77.0 3.03	72.0 2.83	0.9 0.03	0.8 0.03	35.2	14.3	0.0801	0.55 1.21
25.400 1.0000	19.050 0.7500	-6.4 -0.25	0.5 0.02	50.0 1.97	51.0 2.01	3.3 0.13	77.0 3.03	72.0 2.83	1.0 0.04	0.7 0.03	35.2	14.3	0.0801	0.55 1.22
25.400 1.0000	19.050 0.7500	-6.4 -0.25	5.0 0.20	50.0 1.97	60.0 2.36	3.3 0.13	77.0 3.03	72.0 2.83	1.0 0.04	0.7 0.03	35.2	14.3	0.0801	0.54 1.19
25.400 1.0000	19.114 0.7525	-6.4 -0.25	3.5 0.14	50.0 1.97	57.0 2.24	2.0 0.08	77.0 3.03	73.0 2.87	0.9 0.03	0.8 0.03	35.2	14.3	0.0801	0.56 1.23

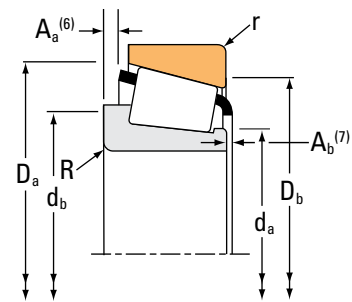
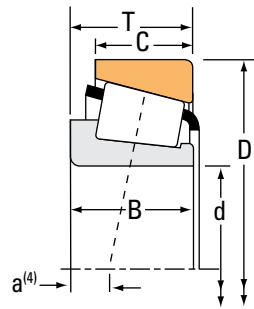
⁽⁴⁾Negative value indicates effective center inside cone (inner-ring) backface.
⁽⁵⁾These maximum fillet radii will be cleared by the bearing corners.
⁽⁶⁾Negative value indicates cage extends beyond cone (inner-ring) backface.
⁽⁷⁾Negative value indicates cage that does not extend beyond cone (inner-ring) front face.

Continued on next page.

TAPERED ROLLER BEARINGS

SINGLE-ROW • TYPE TS

TYPE TS



Bearing Dimensions			Load Ratings							Part Number		
Bore d	O.D. D	Width T	Dynamic ⁽¹⁾		Factors ⁽²⁾		Dynamic ⁽³⁾		Factors ⁽²⁾	Static	Inner	Outer
			C ₁	e	Y	C ₉₀	C _{a90}	K	C ₀			
mm in.	mm in.	mm in.	N lbf			N lbf	N lbf			N lbf		
44.450 1.7500	84.138 3.3125	26.988 1.0625	97000 21800	0.31	1.96	25100 5650	13200 2960	1.91	88800 20000	355	3520	
44.450 1.7500	84.138 3.3125	30.163 1.1875	113000 25500	0.31	1.96	29400 6610	15400 3460	1.91	134000 30100	3578	3520	
44.450 1.7500	85.000 3.3465	20.638 0.8125	97000 21800	0.31	1.96	25100 5650	13200 2960	1.91	88800 20000	355	354A	
44.450 1.7500	85.000 3.3465	20.638 0.8125	97000 21800	0.31	1.96	25100 5650	13200 2960	1.91	88800 20000	355X	354A	
44.450 1.7500	85.000 3.3465	20.638 0.8125	97000 21800	0.31	1.96	25100 5650	13200 2960	1.91	88800 20000	355A	354A	
44.450 1.7500	85.000 3.3465	23.812 0.9375	90500 20300	0.33	1.79	23500 5270	13500 3020	1.74	111000 24900	25580	25526	
44.450 1.7500	85.000 3.3465	25.400 1.0000	93300 21000	0.35	1.73	24200 5440	14300 3220	1.69	117000 26200	2975	2924	
44.450 1.7500	87.312 3.4375	26.988 1.0625	97000 21800	0.31	1.96	25100 5650	13200 2960	1.91	88800 20000	355	3525	
44.450 1.7500	87.312 3.4375	26.988 1.0625	93300 21000	0.35	1.73	24200 5440	14300 3220	1.69	117000 26200	2975	2925	
44.450 1.7500	87.312 3.4375	30.162 1.1875	113000 25500	0.31	1.96	29400 6610	15400 3460	1.91	134000 30100	3578	3525	
44.450 1.7500	87.312 3.4375	30.162 1.1875	113000 25500	0.31	1.96	29400 6610	15400 3460	1.91	134000 30100	3578	3526	
44.450 1.7500	87.312 3.4375	30.162 1.1875	113000 25500	0.31	1.96	29400 6610	15400 3460	1.91	134000 30100	3578A	3525	
44.450 1.7500	88.900 3.5000	30.162 1.1875	114000 25600	0.55	1.10	29500 6630	27600 6200	1.07	144000 32400	HM803149	HM803110	
44.450 1.7500	88.900 3.5000	30.162 1.1875	114000 25600	0.55	1.10	29500 6630	27600 6200	1.07	144000 32400	HM803149	HM803111	
44.450 1.7500	90.119 3.5480	23.000 0.9055	97000 21800	0.31	1.96	25100 5650	13200 2960	1.91	88800 20000	355X	352	
44.450 1.7500	93.264 3.6718	30.162 1.1875	122000 27500	0.34	1.77	31700 7120	18300 4120	1.73	153000 34300	3782	3720	
44.450 1.7500	93.662 3.6875	31.750 1.2500	136000 30500	0.36	1.67	35200 7900	21700 4870	1.62	156000 35000	49175	49368	

⁽¹⁾Based on 1 x 10⁶ revolutions L₁₀ life, for the ISO life-calculation method.

⁽²⁾Consult your Timken engineer for instructions on use or review the Timken Engineering Manual on timken.com/catalogs.

⁽³⁾Based on 90 x 10⁶ revolutions L₁₀ life, for The Timken Company life-calculation method. C₉₀ and C_{a90} are radial and thrust values.

Bearing Dimensions											Geometry Factors			Bearing Weight
Width B	Width C	Eff. Ctr. a ⁽⁴⁾	Shaft			Housing			Cage		G ₁	G ₂	C _g	
			Max Shaft Fillet Radius R ⁽⁵⁾	Backing Shoulder Dia. d _a d _b		Max Housing Fillet Radius r ⁽⁵⁾	Backing Shoulder Dia. D _a D _b		A _a ⁽⁶⁾	A _b ⁽⁷⁾				
mm in.	mm in.	mm in.	mm in.	mm in.	mm in.	mm in.	mm in.	mm in.	mm in.	mm in.				kg lbs.
21.692 0.8540	23.812 0.9375	-4.8 -0.19	2.3 0.09	50.0 1.97	54.0 2.13	3.3 0.13	79.5 3.13	74.0 2.91	0.4 0.01	1.7 0.07	30.0	12.2	0.0732	0.57 1.25
30.886 1.2160	23.812 0.9375	-10.2 -0.40	3.5 0.14	51.0 2.01	57.0 2.24	3.3 0.13	79.5 3.13	74.0 2.91	2.2 0.09	0.7 0.03	39.5	12.5	0.0808	0.69 1.51
21.692 0.8540	17.462 0.6875	-4.8 -0.19	2.3 0.09	50.0 1.97	54.0 2.13	1.3 0.05	80.0 3.15	77.0 3.03	0.4 0.01	1.7 0.07	30.0	12.2	0.0732	0.51 1.12
21.692 0.8540	17.462 0.6875	-4.8 -0.19	3.5 0.14	50.0 1.97	56.0 2.20	1.3 0.05	80.0 3.15	77.0 3.03	0.4 0.01	1.7 0.07	30.0	12.2	0.0732	0.50 1.11
21.692 0.8540	17.462 0.6875	-4.8 -0.19	0.8 0.03	50.0 1.97	51.0 2.01	1.3 0.05	80.0 3.15	77.0 3.03	0.4 0.01	1.7 0.07	30.0	12.2	0.0732	0.51 1.13
25.400 1.0000	19.050 0.7500	-6.4 -0.25	3.5 0.14	50.0 1.97	57.0 2.24	2.3 0.09	78.0 3.07	74.0 2.91	0.9 0.03	0.8 0.03	35.2	14.3	0.0801	0.60 1.30
25.608 1.0082	20.638 0.8125	-6.4 -0.25	3.5 0.14	51.0 2.01	57.0 2.24	1.3 0.05	80.0 3.15	76.0 2.99	1.7 0.07	1.1 0.05	38.2	15.7	0.0832	0.63 1.39
21.692 0.8540	23.812 0.9375	-4.8 -0.19	2.3 0.09	50.0 1.97	54.0 2.13	3.3 0.13	81.0 3.19	75.0 2.95	0.4 0.01	1.7 0.07	30.0	12.2	0.0732	0.65 1.42
25.608 1.0082	22.225 0.8750	-6.4 -0.25	3.5 0.14	51.0 2.01	57.0 2.24	2.3 0.09	81.0 3.19	75.0 2.95	1.7 0.07	1.1 0.05	38.2	15.7	0.0832	0.70 1.55
30.886 1.2160	23.812 0.9375	-10.2 -0.40	3.5 0.14	51.0 2.01	57.0 2.24	3.3 0.13	81.0 3.19	75.0 2.95	2.2 0.09	0.7 0.03	39.5	12.5	0.0808	0.77 1.68
30.886 1.2160	23.812 0.9375	-10.2 -0.40	3.5 0.14	51.0 2.01	57.0 2.24	0.8 0.03	81.0 3.19	77.0 3.03	2.2 0.09	0.7 0.03	39.5	12.5	0.0808	0.78 1.71
30.886 1.2160	23.812 0.9375	-10.2 -0.40	5.5 0.22	51.0 2.01	61.0 2.40	3.3 0.13	81.0 3.19	75.0 2.95	2.2 0.09	0.7 0.03	39.5	12.5	0.0808	0.76 1.66
29.370 1.1563	23.020 0.9063	-4.3 -0.17	3.5 0.14	53.4 2.10	62.0 2.44	3.3 0.13	85.0 3.35	74.0 2.91	1.5 0.05	2.2 0.09	39.2	10.6	0.0974	0.84 1.85
29.370 1.1563	23.020 0.9063	-4.3 -0.17	3.5 0.14	53.4 2.10	62.0 2.44	0.8 0.03	85.0 3.35	76.0 2.99	1.5 0.05	2.2 0.09	39.2	10.6	0.0974	0.85 1.88
21.692 0.8540	21.808 0.8586	-4.8 -0.19	3.5 0.14	50.0 1.97	56.0 2.20	2.3 0.09	82.0 3.23	78.0 3.07	0.4 0.01	1.7 0.07	30.0	12.2	0.0732	0.66 1.46
30.302 1.1930	23.812 0.9375	-8.1 -0.32	3.5 0.14	52.0 2.05	58.0 2.28	3.3 0.13	87.9 3.46	82.0 3.23	1.8 0.07	1.0 0.04	49.9	14.5	0.0903	0.97 2.12
31.750 1.2500	25.400 1.0000	-9.1 -0.36	3.5 0.14	53.0 2.09	59.0 2.32	3.3 0.13	87.0 3.43	82.0 3.23	2.9 0.11	0.8 0.04	42.4	13.6	0.0872	0.98 2.15

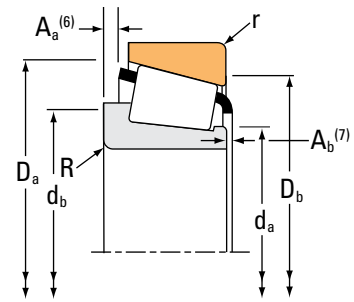
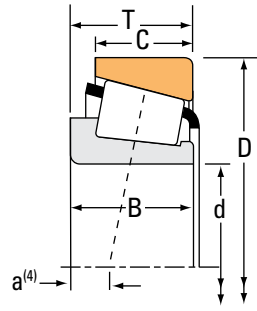
⁽⁴⁾Negative value indicates effective center inside cone (inner-ring) backface.
⁽⁵⁾These maximum fillet radii will be cleared by the bearing corners.
⁽⁶⁾Negative value indicates cage extends beyond cone (inner-ring) backface.
⁽⁷⁾Negative value indicates cage that does not extend beyond cone (inner-ring) front face.

Continued on next page.

TAPERED ROLLER BEARINGS

SINGLE-ROW • TYPE TS

TYPE TS



Bearing Dimensions			Load Ratings							Part Number			
Bore d	O.D. D	Width T	Dynamic ⁽¹⁾		Factors ⁽²⁾		Dynamic ⁽³⁾		Factors ⁽²⁾		Static C ₀	Inner	Outer
			C ₁	e	Y	C ₉₀	C _{a90}	K	N	N			
mm in.	mm in.	mm in.	N lbf			N lbf	N lbf		N lbf				
44.450 1.7500	93.662 3.6875	31.750 1.2500	136000 30500	0.36	1.67	35200 7900	21700 4870	1.62	156000 35000			49176	49368
44.450 1.7500	93.662 3.6875	31.750 1.2500	129000 29100	0.40	1.49	33500 7540	23100 5190	1.45	158000 35500			46175	46368
44.450 1.7500	93.662 3.6875	31.750 1.2500	129000 29100	0.40	1.49	33500 7540	23100 5190	1.45	158000 35500			46176	46368
44.450 1.7500	95.250 3.7500	27.783 1.0938	127000 28500	0.28	2.11	32900 7400	16000 3600	2.05	144000 32400			438	432
44.450 1.7500	95.250 3.7500	27.783 1.0938	127000 28500	0.28	2.11	32900 7400	16000 3600	2.05	144000 32400			435	432
44.450 1.7500	95.250 3.7500	27.783 1.0938	130000 29200	0.33	1.82	33600 7560	19000 4270	1.77	161000 36200			33885	33821
44.450 1.7500	95.250 3.7500	27.783 1.0938	127000 28500	0.28	2.11	32900 7400	16000 3600	2.05	144000 32400			438	432A
44.450 1.7500	95.250 3.7500	27.783 1.0938	130000 29200	0.33	1.82	33600 7560	19000 4270	1.77	161000 36200			33885	33822
44.450 1.7500	95.250 3.7500	30.162 1.1875	147000 33100	0.55	1.10	38200 8590	35700 8030	1.07	157000 35400			HM804843	HM804810
44.450 1.7500	95.250 3.7500	30.162 1.1875	147000 33100	0.55	1.10	38200 8590	35700 8030	1.07	157000 35400			HM804842	HM804811
44.450 1.7500	95.250 3.7500	30.162 1.1875	122000 27500	0.34	1.77	31700 7120	18300 4120	1.73	153000 34300			3782	3726
44.450 1.7500	95.250 3.7500	30.162 1.1875	147000 33100	0.55	1.10	38200 8590	35700 8030	1.07	157000 35400			HM804842	HM804810
44.450 1.7500	95.250 3.7500	30.958 1.2188	119000 26700	0.74	0.81	30800 6920	39000 8760	0.79	104000 23400			53176	53375
44.450 1.7500	95.250 3.7500	30.958 1.2188	119000 26700	0.74	0.81	30800 6920	39000 8760	0.79	104000 23400			53178	53375
44.450 1.7500	95.250 3.7500	30.958 1.2188	119000 26700	0.74	0.81	30800 6920	39000 8760	0.79	104000 23400			53177	53375
44.450 1.7500	95.250 3.7500	30.958 1.2188	136000 30700	0.74	0.81	35400 7950	44800 10100	0.79	132000 29700			HM903249	HM903210
44.450 1.7500	95.250 3.7500	30.958 1.2188	119000 26700	0.74	0.81	30800 6920	39000 8760	0.79	104000 23400			53176	53377

⁽¹⁾Based on 1 x 10⁶ revolutions L₁₀ life, for the ISO life-calculation method.

⁽²⁾Consult your Timken engineer for instructions on use or review the Timken Engineering Manual on timken.com/catalogs.

⁽³⁾Based on 90 x 10⁶ revolutions L₁₀ life, for The Timken Company life-calculation method. C₉₀ and C_{a90} are radial and thrust values.

Bearing Dimensions											Geometry Factors			Bearing Weight
Width B	Width C	Eff. Ctr. a ⁽⁴⁾	Shaft			Housing			Cage		G ₁	G ₂	C _g	
			Max Shaft Fillet Radius R ⁽⁵⁾	Backing Shoulder Dia. d _a	Shoulder Dia. d _b	Max Housing Fillet Radius r ⁽⁵⁾	Backing Shoulder Dia. D _a	Shoulder Dia. D _b	A _a ⁽⁶⁾	A _b ⁽⁷⁾				
mm in.	mm in.	mm in.	mm in.	mm in.	mm in.	mm in.	mm in.	mm in.	mm in.	mm in.				kg lbs.
31.750 1.2500	25.400 1.0000	-9.1 -0.36	0.8 0.03	53.0 2.09	54.0 2.13	3.3 0.13	87.0 3.43	82.0 3.23	2.9 0.11	0.8 0.04	42.4	13.6	0.0872	0.99 2.16
31.750 1.2500	26.195 1.0313	-7.9 -0.31	0.8 0.03	54.0 2.13	55.0 2.17	3.3 0.13	87.0 3.43	79.0 3.11	2.1 0.08	1.1 0.05	44.4	13.6	0.0920	1.03 2.25
31.750 1.2500	26.195 1.0313	-7.9 -0.31	3.5 0.14	54.0 2.13	60.0 2.36	3.3 0.13	87.0 3.43	79.0 3.11	2.1 0.08	1.1 0.05	44.4	13.6	0.0920	1.02 2.24
29.900 1.1772	22.225 0.8750	-9.1 -0.36	3.5 0.14	51.0 2.01	57.0 2.24	2.3 0.09	87.0 3.43	83.0 3.27	1.6 0.06	0.5 0.02	42.5	11.3	0.0805	0.93 2.06
29.900 1.1772	22.225 0.8750	-9.1 -0.36	0.8 0.03	51.0 2.01	52.0 2.05	2.3 0.09	87.0 3.43	83.0 3.27	1.6 0.06	0.5 0.02	42.5	11.3	0.0805	0.94 2.07
28.575 1.1250	22.225 0.8750	-7.6 -0.30	0.8 0.03	53.0 2.09	53.0 2.09	2.3 0.09	90.0 3.54	85.0 3.35	1.3 0.05	2.2 0.09	52.5	18.5	0.0910	0.96 2.12
29.900 1.1772	22.225 0.8750	-9.1 -0.36	3.5 0.14	51.0 2.01	57.0 2.24	0.8 0.03	87.0 3.43	84.0 3.31	1.6 0.06	0.5 0.02	42.5	11.3	0.0805	0.93 2.07
28.575 1.1250	22.225 0.8750	-7.6 -0.30	0.8 0.03	53.0 2.09	53.0 2.09	0.8 0.03	90.0 3.54	86.0 3.39	1.3 0.05	2.2 0.09	52.5	18.5	0.0910	0.97 2.13
29.370 1.1563	23.020 0.9063	-3.8 -0.15	3.5 0.14	57.0 2.24	63.0 2.48	3.3 0.13	91.0 3.58	81.0 3.19	2.2 0.09	2.8 0.11	44.8	13.8	0.1017	1.02 2.25
29.370 1.1563	23.020 0.9063	-3.8 -0.15	0.8 0.03	57.0 2.24	57.0 2.24	0.8 0.03	91.0 3.58	83.0 3.27	2.2 0.09	2.8 0.11	44.8	13.8	0.1017	1.04 2.28
30.302 1.1930	23.812 0.9375	-8.1 -0.32	3.5 0.14	52.0 2.05	58.0 2.28	3.3 0.13	88.9 3.50	83.1 3.27	1.8 0.07	1.0 0.04	49.9	14.5	0.0903	1.02 2.23
29.370 1.1563	23.020 0.9063	-3.8 -0.15	0.8 0.03	57.0 2.24	57.0 2.24	3.3 0.13	91.0 3.58	81.0 3.19	2.2 0.09	2.8 0.11	44.8	13.8	0.1017	1.03 2.27
28.300 1.1142	20.638 0.8125	-0.3 -0.01	1.3 0.05	52.7 2.07	59.0 2.32	0.8 0.03	89.0 3.50	81.0 3.19	5.7 0.22	2.2 0.09	26.7	9.6	0.0930	0.92 2.05
28.300 1.1142	20.638 0.8125	-0.3 -0.01	2.0 0.08	52.7 2.07	60.0 2.36	0.8 0.03	89.0 3.50	81.0 3.19	5.7 0.22	2.2 0.09	26.7	9.6	0.0930	0.92 2.05
28.300 1.1142	20.638 0.8125	-0.3 -0.01	3.5 0.14	52.7 2.07	63.0 2.48	0.8 0.03	89.0 3.50	81.0 3.19	5.7 0.22	2.2 0.09	26.7	9.6	0.0930	0.92 2.04
28.575 1.1250	22.225 0.8750	0.5 0.02	3.5 0.14	54.0 2.13	65.0 2.56	0.8 0.03	91.0 3.58	81.0 3.19	3.9 0.15	2.1 0.08	33.7	12.4	0.1010	0.99 2.19
28.300 1.1142	20.638 0.8125	-0.3 -0.01	1.3 0.05	52.7 2.07	59.0 2.32	2.3 0.09	89.0 3.50	80.0 3.15	5.7 0.22	2.2 0.09	26.7	9.6	0.0930	0.92 2.04

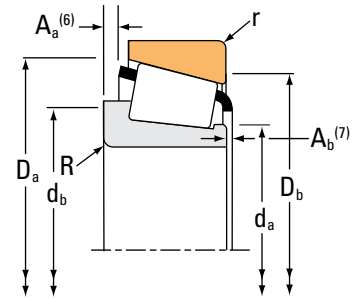
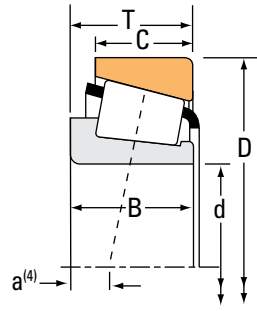
(4) Negative value indicates effective center inside cone (inner-ring) backface.
 (5) These maximum fillet radii will be cleared by the bearing corners.
 (6) Negative value indicates cage extends beyond cone (inner-ring) backface.
 (7) Negative value indicates cage that does not extend beyond cone (inner-ring) front face.

Continued on next page.

TAPERED ROLLER BEARINGS

SINGLE-ROW • TYPE TS

TYPE TS



Bearing Dimensions			Load Ratings							Part Number			
Bore d	O.D. D	Width T	Dynamic ⁽¹⁾		Factors ⁽²⁾		Dynamic ⁽³⁾		Factors ⁽²⁾		Static C ₀	Inner	Outer
			C ₁	e	Y	C ₉₀	C _{a90}	K	N	N			
mm in.	mm in.	mm in.	N lbf			N lbf	N lbf				N lbf		
44.450 1.7500	95.250 3.7500	30.958 1.2188	136000 30700	0.74	0.81	35400 7950	44800 10100	0.79			132000 29700	HM903247	HM903210
44.450 1.7500	95.250 3.7500	30.958 1.2188	136000 30700	0.74	0.81	35400 7950	44800 10100	0.79			132000 29700	HM903249A	HM903210
44.450 1.7500	96.838 3.8125	21.000 0.8268	98600 22200	0.35	1.69	25500 5740	15500 3480	1.65			107000 24100	386AS	382A
44.450 1.7500	98.425 3.8750	30.162 1.1875	122000 27500	0.34	1.77	31700 7120	18300 4120	1.73			153000 34300	3782	3732
44.450 1.7500	98.425 3.8750	30.958 1.2188	119000 26700	0.74	0.81	30800 6920	39000 8760	0.79			104000 23400	53176	53387
44.450 1.7500	98.425 3.8750	30.958 1.2188	119000 26700	0.74	0.81	30800 6920	39000 8760	0.79			104000 23400	53177	53387
44.450 1.7500	98.425 3.8750	30.958 1.2188	119000 26700	0.74	0.81	30800 6920	39000 8760	0.79			104000 23400	53177	53387X
44.450 1.7500	98.425 3.8750	30.958 1.2188	136000 30700	0.74	0.81	35400 7950	44800 10100	0.79			132000 29700	HM903247	HM903216
44.450 1.7500	98.425 3.8750	30.958 1.2188	136000 30700	0.74	0.81	35400 7950	44800 10100	0.79			132000 29700	HM903249A	HM903216
44.450 1.7500	98.425 3.8750	30.958 1.2188	136000 30700	0.74	0.81	35400 7950	44800 10100	0.79			132000 29700	HM903249	HM903216
44.450 1.7500	98.425 3.8750	30.958 1.2188	119000 26700	0.74	0.81	30800 6920	39000 8760	0.79			104000 23400	53176	53387X
44.450 1.7500	101.600 4.0000	30.958 1.2188	119000 26700	0.74	0.81	30800 6920	39000 8760	0.79			104000 23400	53177	53398
44.450 1.7500	101.600 4.0000	30.958 1.2188	119000 26700	0.74	0.81	30800 6920	39000 8760	0.79			104000 23400	53176	53398
44.450 1.7500	101.600 4.0000	31.750 1.2500	133000 29800	0.40	1.50	34400 7740	23600 5310	1.46			155000 35000	49577	49520
44.450 1.7500	101.600 4.0000	31.750 1.2500	157000 35400	0.40	1.50	40800 9170	28000 6290	1.46			155000 35000	49576	49520
44.450 1.7500	101.600 4.0000	34.925 1.3750	165000 37000	0.29	2.10	42700 9600	20800 4690	2.05			191000 43000	527	522
44.450 1.7500	103.188 4.0625	43.658 1.7188	212000 47700	0.30	2.02	55000 12400	27900 6280	1.97			267000 60100	5356	5335

⁽¹⁾Based on 1 x 10⁶ revolutions L₁₀ life, for the ISO life-calculation method.

⁽²⁾Consult your Timken engineer for instructions on use or review the Timken Engineering Manual on timken.com/catalogs.

⁽³⁾Based on 90 x 10⁶ revolutions L₁₀ life, for The Timken Company life-calculation method. C₉₀ and C_{a90} are radial and thrust values.

Bearing Dimensions											Geometry Factors			Bearing Weight
Width B	Width C	Eff. Ctr. a ⁽⁴⁾	Shaft			Housing			Cage		G ₁	G ₂	C _g	
			Max Shaft Fillet Radius R ⁽⁵⁾	Backing Shoulder Dia. d _a d _b		Max Housing Fillet Radius r ⁽⁵⁾	Backing Shoulder Dia. D _a D _b		A _a ⁽⁶⁾	A _b ⁽⁷⁾				
mm in.	mm in.	mm in.	mm in.	mm in.	mm in.	mm in.	mm in.	mm in.	mm in.	mm in.				kg lbs.
28.300 1.1142	22.225 0.8750	0.5 0.02	1.3 0.05	54.0 2.13	61.0 2.40	0.8 0.03	91.0 3.58	81.0 3.19	3.9 0.15	2.3 0.09	33.7	12.4	0.1010	0.99 2.20
28.300 1.1142	22.225 0.8750	0.5 0.02	3.5 0.14	54.0 2.13	65.0 2.56	0.8 0.03	91.0 3.58	81.0 3.19	3.9 0.15	2.3 0.09	33.7	12.4	0.1010	0.99 2.19
21.946 0.8640	15.875 0.6250	-3.0 -0.12	3.5 0.14	53.0 2.09	59.0 2.32	0.8 0.03	92.0 3.62	89.0 3.50	1.1 0.04	2.0 0.08	42.0	15.7	0.0859	0.76 1.68
30.302 1.1930	23.812 0.9375	-8.1 -0.32	3.5 0.14	52.0 2.05	58.0 2.28	3.3 0.13	89.9 3.54	84.1 3.31	1.8 0.07	1.0 0.04	49.9	14.5	0.0903	1.11 2.42
28.300 1.1142	20.638 0.8125	-0.3 -0.01	1.3 0.05	52.7 2.07	59.0 2.32	0.8 0.03	91.0 3.58	82.0 3.23	5.7 0.22	2.2 0.09	26.7	9.6	0.0930	1.00 2.22
28.300 1.1142	20.638 0.8125	-0.3 -0.01	3.5 0.14	52.7 2.07	63.0 2.48	0.8 0.03	91.0 3.58	82.0 3.23	5.7 0.22	2.2 0.09	26.7	9.6	0.0930	1.00 2.21
28.300 1.1142	20.638 0.8125	-0.3 -0.01	3.5 0.14	52.7 2.07	63.0 2.48	1.5 0.06	91.0 3.58	82.0 3.23	5.7 0.22	2.2 0.09	26.7	9.6	0.0930	1.00 2.20
28.300 1.1142	22.225 0.8750	0.5 0.02	1.3 0.05	54.0 2.13	61.0 2.40	0.8 0.03	92.0 3.62	82.0 3.23	3.9 0.15	2.3 0.09	33.7	12.4	0.1010	1.08 2.38
28.300 1.1142	22.225 0.8750	0.5 0.02	3.5 0.14	54.0 2.13	65.0 2.56	0.8 0.03	92.0 3.62	82.0 3.23	3.9 0.15	2.3 0.09	33.7	12.4	0.1010	1.08 2.37
28.575 1.1250	22.225 0.8750	0.5 0.02	3.5 0.14	54.0 2.13	65.0 2.56	0.8 0.03	92.0 3.62	82.0 3.23	3.9 0.15	2.1 0.08	33.7	12.4	0.1010	1.08 2.38
28.300 1.1142	20.638 0.8125	-0.3 -0.01	1.3 0.05	52.7 2.07	59.0 2.32	1.5 0.06	91.0 3.58	82.0 3.23	5.7 0.22	2.2 0.09	26.7	9.6	0.0930	1.00 2.22
28.300 1.1142	20.638 0.8125	-0.3 -0.01	3.5 0.14	52.7 2.07	63.0 2.48	0.8 0.03	92.0 3.62	84.0 3.31	5.7 0.22	2.2 0.09	26.7	9.6	0.0930	1.08 2.39
28.300 1.1142	20.638 0.8125	-0.3 -0.01	1.3 0.05	52.7 2.07	59.0 2.32	0.8 0.03	92.0 3.62	84.0 3.31	5.7 0.22	2.2 0.09	26.7	9.6	0.0930	1.08 2.40
31.750 1.2500	25.400 1.0000	-7.1 -0.28	3.5 0.14	54.0 2.13	60.0 2.36	3.3 0.13	96.0 3.78	88.0 3.46	2.3 0.09	1.4 0.06	49.1	16.8	0.0946	1.24 2.73
31.750 1.2500	25.400 1.0000	-7.1 -0.28	0.8 0.03	54.0 2.13	55.0 2.17	3.3 0.13	96.0 3.78	88.0 3.46	2.3 0.09	1.4 0.06	49.1	16.8	0.0946	1.25 2.74
36.068 1.4200	26.988 1.0625	-12.7 -0.50	3.5 0.14	53.0 2.09	59.0 2.32	3.3 0.13	95.0 3.74	89.0 3.50	2.7 0.10	1.8 0.07	57.9	13.4	0.0894	1.37 3.01
44.475 1.7510	36.512 1.4375	-16.0 -0.63	1.3 0.05	56.0 2.20	58.0 2.28	3.3 0.13	97.0 3.82	89.0 3.50	2.5 0.10	1.0 0.04	73.4	15.5	0.0985	1.85 4.07

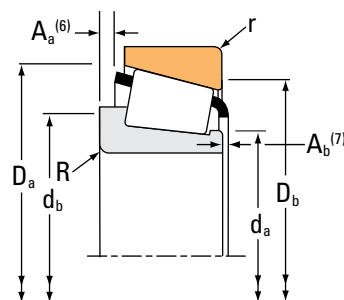
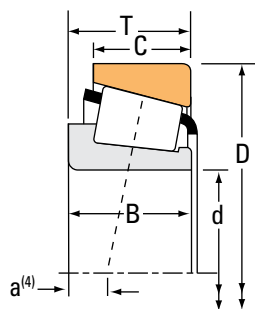
(4) Negative value indicates effective center inside cone (inner-ring) backface.
 (5) These maximum fillet radii will be cleared by the bearing corners.
 (6) Negative value indicates cage extends beyond cone (inner-ring) backface.
 (7) Negative value indicates cage that does not extend beyond cone (inner-ring) front face.

Continued on next page.

TAPERED ROLLER BEARINGS

SINGLE-ROW • TYPE TS

TYPE TS



Bearing Dimensions			Load Ratings							Part Number		
Bore d	O.D. D	Width T	Dynamic ⁽¹⁾		Factors ⁽²⁾		Dynamic ⁽³⁾		Factors ⁽²⁾	Static	Inner	Outer
			C ₁	e	Y	C ₉₀	C _{a90}	K	C ₀			
mm in.	mm in.	mm in.	N lbf			N lbf	N lbf			N lbf		
44.450 1.7500	104.775 4.1250	30.162 1.1875	153000 34500	0.33	1.80	39700 8930	22600 5090	1.76		189000 42600	45280	45220
44.450 1.7500	104.775 4.1250	30.162 1.1875	161000 36100	0.34	1.79	41700 9370	23900 5380	1.74		166000 37200	460	453X
44.450 1.7500	104.775 4.1250	36.512 1.4375	202000 45500	0.40	1.49	52400 11800	36100 8110	1.45		202000 45400	59175	59412
44.450 1.7500	104.775 4.1250	36.512 1.4375	202000 45500	0.40	1.49	52400 11800	36100 8110	1.45		202000 45400	59176	59413
44.450 1.7500	104.775 4.1250	36.512 1.4375	202000 45500	0.40	1.49	52400 11800	36100 8110	1.45		202000 45400	59175	59413
44.450 1.7500	104.775 4.1250	36.512 1.4375	203000 45700	0.49	1.23	52700 11900	44000 9890	1.20		223000 50200	HM807040	HM807010
44.450 1.7500	104.775 4.1250	36.512 1.4375	202000 45500	0.40	1.49	52400 11800	36100 8110	1.45		202000 45400	59176	59412
44.450 1.7500	105.000 4.1339	36.873 1.4517	203000 45700	0.49	1.23	52700 11900	44000 9890	1.20		223000 50200	HM807040	JHM807012
44.450 1.7500	107.950 4.2500	27.783 1.0938	161000 36100	0.34	1.79	41700 9370	23900 5380	1.74		166000 37200	460	453A
44.450 1.7500	107.950 4.2500	36.512 1.4375	202000 45500	0.40	1.49	52400 11800	36100 8110	1.45		202000 45400	59176	59425
44.450 1.7500	111.125 4.3750	30.162 1.1875	126000 28300	0.88	0.68	32700 7350	49500 11100	0.66		119000 26700	55175	55437
44.450 1.7500	111.125 4.3750	30.162 1.1875	123000 27700	0.88	0.68	31900 7170	48200 10800	0.66		153000 34400	HM907635	HM907614
44.450 1.7500	111.125 4.3750	30.162 1.1875	151000 34000	0.88	0.68	39200 8810	59300 13300	0.66		161000 36200	55176C	55437
44.450 1.7500	111.125 4.3750	30.162 1.1875	151000 34000	0.88	0.68	39200 8810	59300 13300	0.66		161000 36200	55175C	55437
44.450 1.7500	111.125 4.3750	38.100 1.5000	172000 38700	0.30	2.02	44600 10000	22700 5090	1.97		206000 46200	535	532A
44.450 1.7500	112.712 4.4375	30.162 1.1875	126000 28300	0.88	0.68	32700 7350	49500 11100	0.66		119000 26700	55175	55443
44.450 1.7500	112.712 4.4375	30.162 1.1875	123000 27700	0.88	0.68	31900 7170	48200 10800	0.66		153000 34400	HM907635	HM907616

⁽¹⁾Based on 1 x 10⁶ revolutions L₁₀ life, for the ISO life-calculation method.

⁽²⁾Consult your Timken engineer for instructions on use or review the Timken Engineering Manual on timken.com/catalogs.

⁽³⁾Based on 90 x 10⁶ revolutions L₁₀ life, for The Timken Company life-calculation method. C₉₀ and C_{a90} are radial and thrust values.

Bearing Dimensions											Geometry Factors			Bearing Weight
Width B	Width C	Eff. Ctr. a ⁽⁴⁾	Shaft			Housing			Cage		G ₁	G ₂	C _g	
			Max Shaft Fillet Radius R ⁽⁵⁾	Backing Shoulder Dia. d _a	Shoulder Dia. d _b	Max Housing Fillet Radius r ⁽⁵⁾	Backing Shoulder Dia. D _a	Shoulder Dia. D _b	A _a ⁽⁶⁾	A _b ⁽⁷⁾				
mm in.	mm in.	mm in.	mm in.	mm in.	mm in.	mm in.	mm in.	mm in.	mm in.	mm in.				kg lbs.
30.958 1.2188	23.812 0.9375	-8.1 -0.32	0.8 0.03	54.0 2.13	55.0 2.17	3.3 0.13	99.0 3.90	93.0 3.66	2.1 0.08	1.8 0.07	63.5	16.9	0.0971	1.34 2.93
29.317 1.1542	24.605 0.9687	-7.1 -0.28	3.5 0.14	54.0 2.13	60.0 2.36	3.3 0.13	98.0 3.86	92.0 3.62	2.1 0.08	1.4 0.06	58.6	17.1	0.0946	1.28 2.81
36.512 1.4375	28.575 1.1250	-9.7 -0.38	3.5 0.14	56.0 2.20	63.0 2.48	3.3 0.13	99.0 3.90	92.0 3.62	3.4 0.13	1.3 0.05	57.3	15.2	0.0999	1.54 3.39
36.512 1.4375	28.575 1.1250	-9.7 -0.38	0.8 0.03	56.0 2.20	57.0 2.24	0.8 0.03	102.0 4.02	87.0 3.43	3.4 0.13	1.3 0.05	57.3	15.2	0.0999	1.56 3.44
36.512 1.4375	28.575 1.1250	-9.7 -0.38	3.5 0.14	56.0 2.20	63.0 2.48	0.8 0.03	102.0 4.02	87.0 3.43	3.4 0.13	1.3 0.05	57.3	15.2	0.0999	1.55 3.42
36.512 1.4375	28.575 1.1250	-7.4 -0.29	3.5 0.14	59.0 2.32	66.0 2.60	3.3 0.13	100.0 3.94	89.0 3.50	3.4 0.13	2.0 0.08	63.9	17.1	0.0760	1.60 3.52
36.512 1.4375	28.575 1.1250	-9.7 -0.38	0.8 0.03	56.0 2.20	57.0 2.24	3.3 0.13	99.0 3.90	92.0 3.62	3.4 0.13	1.3 0.05	57.3	15.2	0.0999	1.55 3.41
36.512 1.4375	29.000 1.1417	-7.4 -0.29	3.5 0.14	59.0 2.32	66.0 2.60	2.5 0.10	100.0 3.94	90.0 3.54	3.4 0.13	2.0 0.08	63.9	17.1	0.0760	1.62 3.55
29.317 1.1542	22.225 0.8750	-7.1 -0.28	3.5 0.14	54.0 2.13	60.0 2.36	0.8 0.03	100.0 3.94	97.0 3.82	2.1 0.08	1.4 0.06	58.6	17.1	0.0946	1.33 2.93
36.512 1.4375	28.575 1.1250	-9.7 -0.38	0.8 0.03	56.0 2.20	57.0 2.24	3.3 0.13	101.0 3.98	93.0 3.66	3.4 0.13	1.3 0.05	57.3	15.2	0.0999	1.66 3.67
26.909 1.0594	20.638 0.8125	7.1 0.28	3.5 0.14	60.0 2.36	67.0 2.64	3.3 0.13	105.0 4.13	92.0 3.62	4.8 0.18	3.2 0.13	36.8	13.2	0.1085	1.36 3.02
28.575 1.1250	20.638 0.8125	7.6 0.30	0.8 0.03	65.3 2.56	64.0 2.52	3.3 0.13	105.0 4.13	91.0 3.58	4.6 0.18	2.1 0.08	46.9	17.5	0.1182	1.46 3.21
26.909 1.0594	20.638 0.8125	7.6 0.30	0.8 0.03	65.0 2.56	71.0 2.80	3.3 0.13	105.0 4.13	92.0 3.62	5.0 0.19	3.7 0.15	48.7	18.1	0.1198	1.46 3.20
26.909 1.0594	20.638 0.8125	7.6 0.30	3.5 0.14	64.0 2.52	70.0 2.76	3.3 0.13	105.0 4.13	92.0 3.62	5.0 0.19	3.7 0.15	48.7	18.1	0.1198	1.46 3.20
36.957 1.4550	30.162 1.1875	-12.2 -0.48	3.5 0.14	54.0 2.13	60.0 2.36	3.3 0.13	100.0 3.94	95.0 3.74	2.7 0.10	1.0 0.04	64.3	16.1	0.0938	1.84 4.04
26.909 1.0594	20.638 0.8125	7.1 0.28	3.5 0.14	60.0 2.36	67.0 2.64	3.3 0.13	106.0 4.17	92.0 3.62	4.8 0.18	3.2 0.13	36.8	13.2	0.1085	1.39 3.09
28.575 1.1250	20.638 0.8125	7.6 0.30	0.8 0.03	65.3 2.56	64.0 2.52	3.3 0.13	106.0 4.17	91.0 3.58	4.6 0.18	2.1 0.08	46.9	17.5	0.1182	1.52 3.35

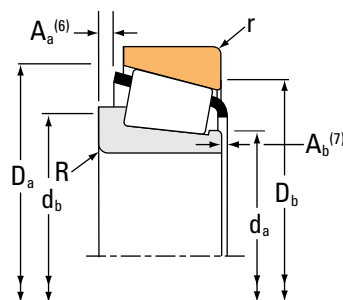
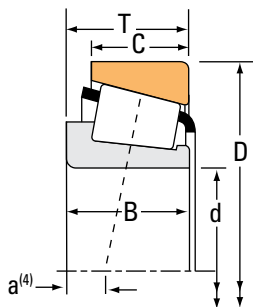
⁽⁴⁾Negative value indicates effective center inside cone (inner-ring) backface.
⁽⁵⁾These maximum fillet radii will be cleared by the bearing corners.
⁽⁶⁾Negative value indicates cage extends beyond cone (inner-ring) backface.
⁽⁷⁾Negative value indicates cage that does not extend beyond cone (inner-ring) front face.

Continued on next page.

TAPERED ROLLER BEARINGS

SINGLE-ROW • TYPE TS

TYPE TS



Bearing Dimensions			Load Ratings							Part Number			
Bore d	O.D. D	Width T	Dynamic ⁽¹⁾		Factors ⁽²⁾		Dynamic ⁽³⁾		Factors ⁽²⁾		Static C ₀	Inner	Outer
			C ₁	e	Y	C ₉₀	C _{a90}	K	N	N			
mm in.	mm in.	mm in.	N lbf			N lbf	N lbf		N lbf				
44.450 1.7500	112.712 4.4375	30.162 1.1875	151000 34000	0.88	0.68	39200 8810	59300 13300	0.66	161000 36200			55176C	55443
44.450 1.7500	114.300 4.5000	44.450 1.7500	224000 50300	0.43	1.39	58000 13000	42700 9600	1.36	256000 57500			65385	65320
44.450 1.7500	114.300 4.5000	44.450 1.7500	224000 50300	0.43	1.39	58000 13000	42700 9600	1.36	256000 57500			65384	65320
44.450 1.7500	120.650 4.7500	41.275 1.6250	207000 46600	0.31	1.91	53800 12100	28900 6510	1.86	244000 54800			615	612
44.450 1.7500	127.000 5.0000	50.800 2.0000	306000 68800	0.30	2.01	79300 17800	40500 9110	1.96	370000 83300			6277	6220
44.983 1.7710	82.931 3.2650	23.812 0.9375	90500 20300	0.33	1.79	23500 5270	13500 3020	1.74	111000 24900			25584	25520
44.983 1.7710	82.931 3.2650	26.988 1.0625	90500 20300	0.33	1.79	23500 5270	13500 3020	1.74	111000 24900			25584	25523
44.983 1.7710	83.058 3.2700	23.812 0.9375	90500 20300	0.33	1.79	23500 5270	13500 3020	1.74	111000 24900			25584	25521
44.983 1.7710	84.988 3.3460	18.999 0.7480	62400 14000	0.44	1.35	16200 3640	12300 2770	1.31	69200 15600			29177	29334
44.983 1.7710	85.000 3.3465	23.812 0.9375	90500 20300	0.33	1.79	23500 5270	13500 3020	1.74	111000 24900			25584	25526
44.983 1.7710	93.264 3.6718	30.162 1.1875	122000 27500	0.34	1.77	31700 7120	18300 4120	1.73	153000 34300			3776	3720
44.987 1.7712	81.973 3.2273	23.876 0.9400	90500 20300	0.33	1.79	23500 5270	13500 3020	1.74	111000 24900			25584A	25518
44.987 1.7712	82.931 3.2650	23.812 0.9375	90500 20300	0.33	1.79	23500 5270	13500 3020	1.74	111000 24900			25584A	25520
44.987 1.7712	90.000 3.5433	25.000 0.9843	85900 19300	0.32	1.88	22300 5010	12200 2740	1.83	95800 21500			367X	362X
44.987 1.7712	95.250 3.7500	30.958 1.2188	115000 25900	0.74	0.81	29800 6710	37800 8490	0.79	132000 29700			HM903248	HM903210
45.000 1.7717	85.000 3.3465	20.638 0.8125	97000 21800	0.31	1.96	25100 5650	13200 2960	1.91	88800 20000			358	354A
45.000 1.7717	85.000 3.3465	20.638 0.8125	81800 18400	0.31	1.96	21200 4770	11100 2500	1.91	88800 20000			358A	354A

⁽¹⁾Based on 1×10^6 revolutions L_{10} life, for the ISO life-calculation method.

⁽²⁾Consult your Timken engineer for instructions on use or review the Timken Engineering Manual on timken.com/catalogs.

⁽³⁾Based on 90×10^6 revolutions L_{10} life, for The Timken Company life-calculation method. C_{90} and C_{a90} are radial and thrust values.

Bearing Dimensions											Geometry Factors			Bearing Weight
Width B	Width C	Eff. Ctr. a ⁽⁴⁾	Shaft			Housing			Cage		G ₁	G ₂	C _g	
			Max Shaft Fillet Radius R ⁽⁵⁾	Backing Shoulder Dia. d _a	mm in.	Max Housing Fillet Radius r ⁽⁵⁾	Backing Shoulder Dia. D _a	mm in.	A _a ⁽⁶⁾	A _b ⁽⁷⁾				
mm in.	mm in.	mm in.	mm in.	mm in.	mm in.	mm in.	mm in.	mm in.	mm in.	mm in.			kg lbs.	
26.909 1.0594	20.638 0.8125	7.6 0.30	0.8 0.03	65.0 2.56	71.0 2.80	3.3 0.13	106.0 4.17	92.0 3.62	5.0 0.19	3.7 0.15	48.7	18.1	0.1198	1.49 3.28
44.450 1.7500	34.925 1.3750	-12.4 -0.49	3.5 0.14	60.0 2.36	67.0 2.64	3.3 0.13	107.0 4.21	97.0 3.82	3.6 0.14	1.1 0.05	63.1	13.0	0.1053	2.31 5.09
44.450 1.7500	34.925 1.3750	-12.4 -0.49	2.0 0.08	60.0 2.36	64.0 2.52	3.3 0.13	107.0 4.21	97.0 3.82	3.6 0.14	1.1 0.05	63.1	13.0	0.1053	2.32 5.10
41.275 1.6250	31.750 1.2500	-14.0 -0.55	3.5 0.14	56.0 2.20	62.0 2.44	3.3 0.13	110.0 4.33	105.0 4.13	3.8 0.15	1.9 0.08	75.9	16.2	0.0694	2.42 5.34
52.388 2.0625	41.275 1.6250	-19.6 -0.77	3.5 0.14	60.0 2.36	67.0 2.64	3.3 0.13	117.0 4.61	108.0 4.25	2.3 0.09	2.6 0.11	103.1	18.7	0.0757	3.57 7.85
25.400 1.0000	19.050 0.7500	-6.4 -0.25	1.5 0.06	51.0 2.01	53.0 2.09	0.8 0.03	77.0 3.03	74.0 2.91	1.0 0.04	0.7 0.03	35.2	14.3	0.0801	0.56 1.22
25.400 1.0000	22.225 0.8750	-6.4 -0.25	1.5 0.06	51.0 2.01	53.0 2.09	2.3 0.09	77.0 3.03	72.0 2.83	1.0 0.04	0.7 0.03	35.2	14.3	0.0801	0.60 1.31
25.400 1.0000	19.050 0.7500	-6.4 -0.25	1.5 0.06	51.0 2.01	53.0 2.09	3.3 0.13	77.0 3.03	72.0 2.83	1.0 0.04	0.7 0.03	35.2	14.3	0.0801	0.55 1.20
19.164 0.7545	15.875 0.6250	-1.3 -0.05	2.0 0.08	50.0 1.97	54.0 2.13	1.5 0.06	78.0 3.07	74.0 2.91	* *	* *	23.8	15.3	0.0766	0.46 1.01
25.400 1.0000	19.050 0.7500	-6.4 -0.25	1.5 0.06	51.0 2.01	53.0 2.09	2.3 0.09	78.0 3.07	74.0 2.91	1.0 0.04	0.7 0.03	35.2	14.3	0.0801	0.60 1.30
30.302 1.1930	23.812 0.9375	-8.1 -0.32	3.5 0.14	53.0 2.09	59.0 2.32	3.3 0.13	87.9 3.46	82.0 3.23	1.8 0.07	1.0 0.04	49.9	14.5	0.0903	0.96 2.10
25.400 1.0000	19.114 0.7525	-6.4 -0.25	3.5 0.14	51.0 2.01	57.0 2.24	1.0 0.04	77.0 3.03	74.0 2.91	1.0 0.04	0.7 0.03	35.2	14.3	0.0801	0.53 1.17
25.400 1.0000	19.050 0.7500	-6.4 -0.25	3.5 0.14	51.0 2.01	57.0 2.24	0.8 0.03	77.0 3.03	74.0 2.91	1.0 0.04	0.7 0.03	35.2	14.3	0.0801	0.55 1.21
22.225 0.8750	20.000 0.7874	-4.3 -0.17	1.5 0.06	51.0 2.01	54.0 2.13	2.0 0.08	84.0 3.31	80.0 3.15	0.4 0.01	1.1 0.04	33.8	14.0	0.0773	0.67 1.47
28.575 1.1250	22.225 0.8750	0.5 0.02	3.5 0.14	54.0 2.13	66.0 2.60	0.8 0.03	91.0 3.58	81.0 3.19	* *	* *	33.7	12.4	0.1010	0.98 2.18
21.692 0.8540	17.462 0.6875	-4.8 -0.19	1.5 0.06	50.0 1.97	53.0 2.09	1.3 0.05	80.0 3.15	77.0 3.03	0.4 0.01	1.7 0.07	30.0	12.2	0.0732	0.50 1.11
21.692 0.8540	17.462 0.6875	-4.8 -0.19	3.5 0.14	50.0 1.97	57.0 2.24	1.3 0.05	80.0 3.15	77.0 3.03	0.4 0.01	1.7 0.07	30.0	12.2	0.0732	0.50 1.10

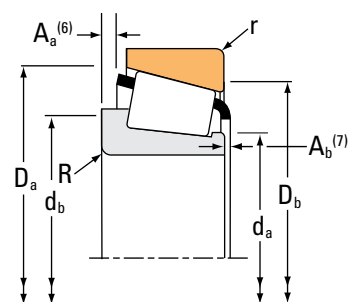
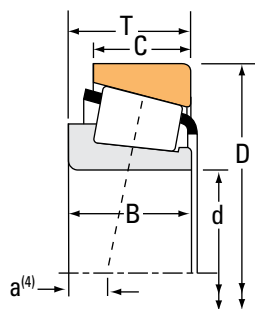
(4) Negative value indicates effective center inside cone (inner-ring) backface.
 (5) These maximum fillet radii will be cleared by the bearing corners.
 (6) Negative value indicates cage extends beyond cone (inner-ring) backface.
 (7) Negative value indicates cage that does not extend beyond cone (inner-ring) front face.
 (*) Contact your Timken engineer for details.

Continued on next page.

TAPERED ROLLER BEARINGS

SINGLE-ROW • TYPE TS

TYPE TS



Bearing Dimensions			Load Ratings							Part Number		
Bore d	O.D. D	Width T	Dynamic ⁽¹⁾ C ₁		Factors ⁽²⁾ e Y		Dynamic ⁽³⁾ C ₉₀ C _{a90}		Factors ⁽²⁾ K	Static C ₀	Inner	Outer
mm in.	mm in.	mm in.	N lbf				N lbf	N lbf		N lbf		
45.000 1.7717	85.000 3.3465	20.638 0.8125	97000 21800	0.31	1.96		25100 5650	13200 2960	1.91	88800 20000	358	354X
45.000 1.7717	85.000 3.3465	20.638 0.8125	81800 18400	0.31	1.96		21200 4770	11100 2500	1.91	88800 20000	358X	354X
45.000 1.7717	87.312 3.4375	26.988 1.0625	97000 21800	0.31	1.96		25100 5650	13200 2960	1.91	88800 20000	358	3525
45.000 1.7717	88.900 3.5000	20.638 0.8125	102000 22900	0.32	1.88		26400 5930	14400 3250	1.83	95800 21500	367	362A
45.000 1.7717	89.980 3.5425	24.750 0.9744	117000 26400	0.38	1.59		30400 6830	19600 4410	1.55	130000 29200	J28577	28520
45.000 1.7717	90.000 3.5433	20.000 0.7874	102000 22900	0.32	1.88		26400 5930	14400 3250	1.83	95800 21500	367	362
45.000 1.7717	90.000 3.5433	27.783 1.0938	127000 28500	0.28	2.11		32900 7400	16000 3600	2.05	144000 32400	435-S	430X
45.000 1.7717	90.119 3.5480	23.000 0.9055	97000 21800	0.31	1.96		25100 5650	13200 2960	1.91	88800 20000	358	352
45.000 1.7717	93.264 3.6718	20.638 0.8125	104000 23400	0.34	1.77		27000 6070	15700 3520	1.73	101000 22700	376	374
45.000 1.7717	95.000 3.7402	29.000 1.1417	118000 26600	0.87	0.69		30700 6900	45500 10200	0.67	114000 25600	JW4549	JW4510
45.000 1.7717	96.838 3.8125	22.225 0.8750	104000 23400	0.34	1.77		27000 6070	15700 3520	1.73	101000 22700	376	372A
45.000 1.7717	100.000 3.9370	24.999 0.9842	104000 23400	0.34	1.77		27000 6070	15700 3520	1.73	101000 22700	376	372
45.000 1.7717	104.775 4.1250	39.688 1.5625	180000 40500	0.34	1.79		46800 10500	26800 6030	1.74	237000 53200	4559	4535
45.000 1.7717	107.950 4.2500	27.783 1.0938	136000 30500	0.34	1.79		35200 7900	20200 4540	1.74	166000 37200	458-S	453A
45.230 1.7807	79.985 3.1490	19.842 0.7812	68900 15500	0.37	1.64		17900 4020	11200 2510	1.60	83300 18700	17887	17831
45.237 1.7810	84.138 3.3125	30.162 1.1875	113000 25500	0.31	1.96		29400 6610	15400 3460	1.91	134000 30100	3586	3520
45.237 1.7810	87.312 3.4375	30.162 1.1875	113000 25500	0.31	1.96		29400 6610	15400 3460	1.91	134000 30100	3586	3525

⁽¹⁾Based on 1×10^6 revolutions L_{10} life, for the ISO life-calculation method.

⁽²⁾Consult your Timken engineer for instructions on use or review the Timken Engineering Manual on timken.com/catalogs.

⁽³⁾Based on 90×10^6 revolutions L_{10} life, for The Timken Company life-calculation method. C_{90} and C_{a90} are radial and thrust values.

Bearing Dimensions											Geometry Factors			Bearing Weight
Width B	Width C	Eff. Ctr. a ⁽⁴⁾	Shaft			Housing			Cage		G ₁	G ₂	C _g	
			Max Shaft Fillet Radius R ⁽⁵⁾	Backing Shoulder Dia. d _a	Backing Shoulder Dia. d _b	Max Housing Fillet Radius r ⁽⁵⁾	Backing Shoulder Dia. D _a	Backing Shoulder Dia. D _b	A _a ⁽⁶⁾	A _b ⁽⁷⁾				
mm in.	mm in.	mm in.	mm in.	mm in.	mm in.	mm in.	mm in.	mm in.	mm in.	mm in.				kg lbs.
21.692 0.8540	17.462 0.6875	-4.8 -0.19	1.5 0.06	50.0 1.97	53.0 2.09	1.5 0.06	80.0 3.15	77.0 3.03	0.4 0.01	1.7 0.07	30.0	12.2	0.0732	0.50 1.12
21.692 0.8540	17.462 0.6875	-4.8 -0.19	2.0 0.08	50.0 1.97	54.0 2.13	1.5 0.06	80.0 3.15	77.0 3.03	0.4 0.01	1.7 0.07	30.0	12.2	0.0732	0.50 1.11
21.692 0.8540	23.812 0.9375	-4.8 -0.19	1.5 0.06	50.0 1.97	53.0 2.09	3.3 0.13	81.0 3.19	75.0 2.95	0.4 0.01	1.7 0.07	30.0	12.2	0.0732	0.64 1.41
22.225 0.8750	16.513 0.6501	-4.3 -0.17	2.0 0.08	51.0 2.01	55.0 2.17	1.3 0.05	84.0 3.31	81.0 3.19	0.4 0.01	1.1 0.04	33.8	14.0	0.0773	0.59 1.29
25.400 1.0000	19.987 0.7869	-4.8 -0.19	0.8 0.03	57.0 2.24	55.0 2.17	2.3 0.09	86.0 3.39	81.0 3.19	1.4 0.05	1.1 0.05	46.4	18.9	0.0912	0.75 1.64
22.225 0.8750	15.875 0.6250	-4.3 -0.17	2.0 0.08	51.0 2.01	55.0 2.17	2.0 0.08	84.0 3.31	81.0 3.19	0.4 0.01	1.1 0.04	33.8	14.0	0.0773	0.59 1.31
29.900 1.1772	22.225 0.8750	-9.1 -0.36	2.0 0.08	51.0 2.01	55.0 2.17	2.0 0.08	84.0 3.31	81.0 3.19	1.6 0.06	0.5 0.02	42.5	11.3	0.0805	0.80 1.76
21.692 0.8540	21.808 0.8586	-4.8 -0.19	1.5 0.06	50.0 1.97	53.0 2.09	2.3 0.09	82.0 3.23	78.0 3.07	0.4 0.01	1.7 0.07	30.0	12.2	0.0732	0.66 1.46
22.225 0.8750	15.083 0.5938	-3.8 -0.15	0.8 0.03	52.0 2.05	53.0 2.09	1.3 0.05	88.0 3.46	85.0 3.35	0.8 0.03	1.5 0.06	37.6	15.4	0.0816	0.67 1.48
26.500 1.0433	20.000 0.7874	4.0 0.16	2.5 0.10	54.0 2.13	64.0 2.52	2.5 0.10	90.0 3.56	78.0 3.07	4.6 0.18	3.1 0.12	30.7	12.9	0.1021	0.90 2.00
22.225 0.8750	19.050 0.7500	-3.8 -0.15	0.8 0.03	52.0 2.05	53.0 2.09	1.5 0.06	90.0 3.54	86.0 3.39	0.8 0.03	1.5 0.06	37.6	15.4	0.0816	0.79 1.75
22.225 0.8750	21.824 0.8592	-3.8 -0.15	0.8 0.03	52.0 2.05	53.0 2.09	2.0 0.08	90.0 3.54	86.0 3.39	0.8 0.03	1.5 0.06	37.6	15.4	0.0816	0.93 2.05
40.157 1.5810	33.338 1.3125	-12.4 -0.49	3.5 0.14	56.0 2.20	62.0 2.44	3.3 0.13	99.0 3.90	90.0 3.54	1.6 0.06	1.3 0.05	73.6	20.2	0.1027	1.76 3.88
29.317 1.1542	22.225 0.8750	-7.1 -0.28	2.3 0.09	55.0 2.17	58.0 2.28	0.8 0.03	100.0 3.94	97.0 3.82	2.1 0.08	1.4 0.06	58.6	17.1	0.0946	1.33 2.92
20.638 0.8125	15.080 0.5937	-3.8 -0.15	2.0 0.08	50.0 1.97	54.0 2.13	1.3 0.05	75.0 2.95	72.0 2.83	1.1 0.04	1.3 0.06	28.9	17.9	0.0770	0.39 0.88
30.886 1.2160	23.812 0.9375	-10.2 -0.40	3.5 0.14	52.0 2.05	58.0 2.28	3.3 0.13	79.5 3.13	74.0 2.91	2.2 0.09	0.7 0.03	39.5	12.5	0.0808	0.68 1.48
30.886 1.2160	23.812 0.9375	-10.2 -0.40	3.5 0.14	52.0 2.05	58.0 2.28	3.3 0.13	81.0 3.19	75.0 2.95	2.2 0.09	0.7 0.03	39.5	12.5	0.0808	0.76 1.65

⁽⁴⁾Negative value indicates effective center inside cone (inner-ring) backface.

⁽⁵⁾These maximum fillet radii will be cleared by the bearing corners.

⁽⁶⁾Negative value indicates cage extends beyond cone (inner-ring) backface.

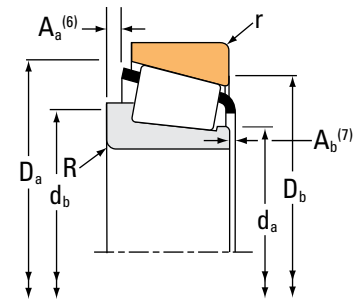
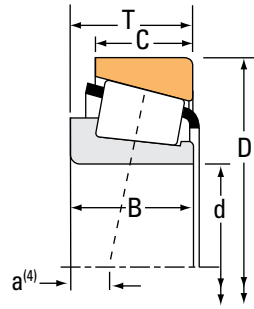
⁽⁷⁾Negative value indicates cage that does not extend beyond cone (inner-ring) front face.

Continued on next page.

TAPERED ROLLER BEARINGS

SINGLE-ROW • TYPE TS

TYPE TS



Bearing Dimensions			Load Ratings							Part Number			
Bore d	O.D. D	Width T	Dynamic ⁽¹⁾		Factors ⁽²⁾		Dynamic ⁽³⁾		Factors ⁽²⁾		Static C ₀	Inner	Outer
			C ₁	e	Y	C ₉₀	C _{a90}	K	N	N			
mm in.	mm in.	mm in.	N lbf			N lbf	N lbf		N lbf				
45.242 1.7812	73.431 2.8910	19.558 0.7700	72900 16400	0.31	1.97	18900 4250	9870 2220	1.91	81800 18400		LM102949	LM102910	
45.242 1.7812	73.431 2.8910	21.430 0.8437	72900 16400	0.31	1.97	18900 4250	9870 2220	1.91	81800 18400		LM102949	LM102911	
45.242 1.7812	77.788 3.0625	19.842 0.7812	76300 17200	0.43	1.41	19800 4450	14500 3250	1.37	77900 17500		LM603049	LM603011	
45.242 1.7812	77.788 3.0625	19.842 0.7812	76300 17200	0.43	1.41	19800 4450	14500 3250	1.37	77900 17500		LM603049AS	LM603011	
45.242 1.7812	77.788 3.0625	21.430 0.8437	76300 17200	0.43	1.41	19800 4450	14500 3250	1.37	77900 17500		LM603049	LM603012	
45.242 1.7812	79.975 3.1486	19.842 0.7812	76300 17200	0.43	1.41	19800 4450	14500 3250	1.37	77900 17500		LM603049	LM603014	
45.242 1.7812	79.975 3.1486	21.430 0.8437	76300 17200	0.43	1.41	19800 4450	14500 3250	1.37	77900 17500		LM603049	LM603015	
45.618 1.7960	82.931 3.2650	23.812 0.9375	90500 20300	0.33	1.79	23500 5270	13500 3020	1.74	111000 24900		25590	25520	
45.618 1.7960	82.931 3.2650	26.988 1.0625	90500 20300	0.33	1.79	23500 5270	13500 3020	1.74	111000 24900		25590	25523	
45.618 1.7960	83.058 3.2700	23.812 0.9375	90500 20300	0.33	1.79	23500 5270	13500 3020	1.74	111000 24900		25590	25521	
45.618 1.7960	83.058 3.2700	23.876 0.9400	90500 20300	0.33	1.79	23500 5270	13500 3020	1.74	111000 24900		25590	25522	
45.618 1.7960	85.000 3.3465	26.988 1.0625	90500 20300	0.33	1.79	23500 5270	13500 3020	1.74	111000 24900		25590	25527	
45.618 1.7960	92.075 3.6250	23.812 0.9375	90500 20300	0.33	1.79	23500 5270	13500 3020	1.74	111000 24900		25590	25528	
45.987 1.8105	74.975 2.9518	18.000 0.7087	67400 15100	0.40	1.49	17500 3930	12000 2700	1.45	75400 17000		LM503349	LM503310	
45.987 1.8105	74.975 2.9518	18.000 0.7087	67400 15100	0.40	1.49	17500 3930	12000 2700	1.45	75400 17000		LM503349A	LM503310	
45.987 1.8105	90.975 3.5817	32.000 1.2598	170000 38300	0.33	1.80	44200 9930	25200 5660	1.76	172000 38600		HM204049	HM204010	
46.037 1.8125	77.788 3.0625	12.700 0.5000	37300 8390	0.34	1.78	9680 2180	5570 1250	1.74	47200 10600		LL205442	LL205410	

⁽¹⁾Based on 1×10^6 revolutions L_{10} life, for the ISO life-calculation method.

⁽²⁾Consult your Timken engineer for instructions on use or review the Timken Engineering Manual on timken.com/catalogs.

⁽³⁾Based on 90×10^6 revolutions L_{10} life, for The Timken Company life-calculation method. C_{90} and C_{a90} are radial and thrust values.

Bearing Dimensions											Geometry Factors			Bearing Weight
Width B	Width C	Eff. Ctr. a ⁽⁴⁾	Shaft			Housing			Cage		G ₁	G ₂	C _g	
			Max Shaft Fillet Radius R ⁽⁵⁾	Backing Shoulder Dia. d _a	Shoulder Dia. d _b	Max Housing Fillet Radius r ⁽⁵⁾	Backing Shoulder Dia. D _a	Shoulder Dia. D _b	A _a ⁽⁶⁾	A _b ⁽⁷⁾				
mm in.	mm in.	mm in.	mm in.	mm in.	mm in.	mm in.	mm in.	mm in.	mm in.	mm in.				kg lbs.
19.812 0.7800	15.748 0.6200	-4.6 -0.18	3.5 0.14	50.0 1.97	56.0 2.20	0.8 0.03	70.0 2.76	68.0 2.68	0.7 0.02	1.1 0.05	31.1	18.8	0.0744	0.31 0.70
19.812 0.7800	17.620 0.6937	-4.6 -0.18	3.5 0.14	50.0 1.97	56.0 2.20	0.8 0.03	70.0 2.76	67.0 2.64	0.7 0.02	1.1 0.05	31.1	18.8	0.0744	0.33 0.74
19.842 0.7812	15.080 0.5937	-2.3 -0.09	3.5 0.14	52.0 2.05	58.0 2.28	0.8 0.03	74.0 2.91	71.0 2.80	1.3 0.05	1.4 0.06	26.4	14.4	0.0785	0.37 0.81
19.842 0.7812	15.080 0.5937	-2.3 -0.09	0.8 0.03	52.0 2.05	53.0 2.09	0.8 0.03	74.0 2.91	71.0 2.80	1.2 0.05	1.5 0.06	26.4	14.4	0.0785	0.37 0.81
19.842 0.7812	16.667 0.6562	-2.3 -0.09	3.5 0.14	52.0 2.05	58.0 2.28	0.8 0.03	74.0 2.91	70.0 2.76	1.3 0.05	1.4 0.06	26.4	14.4	0.0785	0.39 0.85
19.842 0.7812	15.080 0.5937	-2.3 -0.09	3.5 0.14	52.0 2.05	58.0 2.28	0.8 0.03	75.0 2.95	71.0 2.80	1.3 0.05	1.4 0.06	26.4	14.4	0.0785	0.40 0.88
19.842 0.7812	16.667 0.6562	-2.3 -0.09	3.5 0.14	52.0 2.05	58.0 2.28	0.8 0.03	75.0 2.95	71.0 2.80	1.3 0.05	1.4 0.06	26.4	14.4	0.0785	0.42 0.92
25.400 1.0000	19.050 0.7500	-6.4 -0.25	3.5 0.14	51.0 2.01	58.0 2.28	0.8 0.03	77.0 3.03	74.0 2.91	1.0 0.04	0.7 0.03	35.2	14.3	0.0801	0.54 1.19
25.400 1.0000	22.225 0.8750	-6.4 -0.25	3.5 0.14	51.0 2.01	58.0 2.28	2.3 0.09	77.0 3.03	72.0 2.83	1.0 0.04	0.7 0.03	35.2	14.3	0.0801	0.58 1.28
25.400 1.0000	19.050 0.7500	-6.4 -0.25	3.5 0.14	51.0 2.01	58.0 2.28	3.3 0.13	77.0 3.03	72.0 2.83	1.0 0.04	0.7 0.03	35.2	14.3	0.0801	0.53 1.17
25.400 1.0000	19.114 0.7525	-6.4 -0.25	3.5 0.14	51.0 2.01	58.0 2.28	2.0 0.08	77.0 3.03	73.0 2.87	1.0 0.04	0.7 0.03	35.2	14.3	0.0801	0.54 1.19
25.400 1.0000	22.225 0.8750	-6.4 -0.25	3.5 0.14	51.0 2.01	58.0 2.28	2.3 0.09	78.0 3.07	73.0 2.87	1.0 0.04	0.7 0.03	35.2	14.3	0.0801	0.63 1.39
25.400 1.0000	19.050 0.7500	-6.4 -0.25	3.5 0.14	51.0 2.01	58.0 2.28	0.8 0.03	80.0 3.15	78.0 3.07	1.0 0.04	0.7 0.03	35.2	14.3	0.0801	0.73 1.60
18.000 0.7087	14.000 0.5512	-2.0 -0.08	2.3 0.09	51.0 2.01	55.0 2.17	1.5 0.06	71.0 2.80	67.0 2.64	0.9 0.03	1.5 0.06	28.3	22.5	0.0789	0.30 0.67
18.000 0.7087	14.000 0.5512	-2.0 -0.08	0.0 0.00	51.0 2.01	57.0 2.24	1.5 0.06	71.0 2.80	67.0 2.64	0.9 0.03	1.5 0.06	28.3	22.5	0.0789	0.29 0.65
32.000 1.2598	26.500 1.0433	-9.7 -0.38	3.5 0.14	55.0 2.17	63.0 2.48	3.5 0.14	86.0 3.39	79.0 3.11	1.5 0.06	1.9 0.08	47.7	14.5	0.0885	0.91 2.02
12.700 0.5000	9.525 0.3750	0.0 0.00	1.5 0.06	52.0 2.05	54.0 2.13	1.5 0.06	74.0 2.91	71.0 2.80	0.2 0.00	1.7 0.07	24.2	29.1	0.0699	0.23 0.52

⁽⁴⁾Negative value indicates effective center inside cone (inner-ring) backface.

⁽⁵⁾These maximum fillet radii will be cleared by the bearing corners.

⁽⁶⁾Negative value indicates cage extends beyond cone (inner-ring) backface.

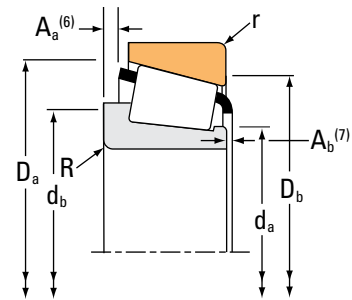
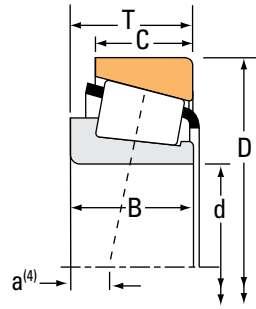
⁽⁷⁾Negative value indicates cage that does not extend beyond cone (inner-ring) front face.

Continued on next page.

TAPERED ROLLER BEARINGS

SINGLE-ROW • TYPE TS

TYPE TS



Bearing Dimensions			Load Ratings						Part Number			
Bore d	O.D. D	Width T	Dynamic ⁽¹⁾ C ₁		Factors ⁽²⁾ e Y		Dynamic ⁽³⁾ C ₉₀ C _{a90}		Factors ⁽²⁾ K	Static C ₀	Inner	Outer
mm in.	mm in.	mm in.	N lbf				N lbf	N lbf		N lbf		
46.037 1.8125	79.375 3.1250	17.462 0.6875	52000 11700	0.37	1.60		13500 3030	8630 1940	1.56	61300 13800	18690	18620
46.037 1.8125	80.962 3.1875	19.050 0.7500	50800 11400	0.53	1.14		13200 2960	11900 2680	1.11	61100 13700	13181	13318
46.037 1.8125	82.931 3.2650	23.812 0.9375	90500 20300	0.33	1.79		23500 5270	13500 3020	1.74	111000 24900	25592	25520
46.037 1.8125	84.138 3.3125	26.995 1.0628	97000 21800	0.31	1.96		25100 5650	13200 2960	1.91	88800 20000	359-S	3520
46.037 1.8125	85.000 3.3465	20.638 0.8125	97000 21800	0.31	1.96		25100 5650	13200 2960	1.91	88800 20000	359A	354A
46.037 1.8125	85.000 3.3465	20.638 0.8125	97000 21800	0.31	1.96		25100 5650	13200 2960	1.91	88800 20000	359-S	354A
46.037 1.8125	85.000 3.3465	20.638 0.8125	97000 21800	0.31	1.96		25100 5650	13200 2960	1.91	88800 20000	359-S	354X
46.037 1.8125	85.000 3.3465	25.400 1.0000	93300 21000	0.35	1.73		24200 5440	14300 3220	1.69	117000 26200	2984	2924
46.037 1.8125	85.000 3.3465	25.400 1.0000	93300 21000	0.35	1.73		24200 5440	14300 3220	1.69	117000 26200	2984A	2924
46.037 1.8125	87.312 3.4375	26.988 1.0625	97000 21800	0.31	1.96		25100 5650	13200 2960	1.91	88800 20000	359-S	3525
46.037 1.8125	87.312 3.4375	26.988 1.0625	93300 21000	0.35	1.73		24200 5440	14300 3220	1.69	117000 26200	2984	2925
46.037 1.8125	88.875 3.4990	23.000 0.9055	97000 21800	0.31	1.96		25100 5650	13200 2960	1.91	88800 20000	359-S	352A
46.037 1.8125	90.119 3.5480	23.000 0.9055	97000 21800	0.31	1.96		25100 5650	13200 2960	1.91	88800 20000	359-S	352
46.037 1.8125	93.264 3.6718	30.162 1.1875	122000 27500	0.34	1.77		31700 7120	18300 4120	1.73	153000 34300	3777	3720
46.037 1.8125	95.250 3.7500	27.783 1.0938	127000 28500	0.28	2.11		32900 7400	16000 3600	2.05	144000 32400	436	432
46.037 1.8125	95.250 3.7500	31.753 1.2501	127000 28500	0.28	2.11		32900 7400	16000 3600	2.05	144000 32400	436	432X
47.625 1.8750	88.900 3.5000	20.638 0.8125	102000 22900	0.32	1.88		26400 5930	14400 3250	1.83	95800 21500	369A	362A

⁽¹⁾Based on 1 x 10⁶ revolutions L₁₀ life, for the ISO life-calculation method.

⁽²⁾Consult your Timken engineer for instructions on use or review the Timken Engineering Manual on timken.com/catalogs.

⁽³⁾Based on 90 x 10⁶ revolutions L₁₀ life, for The Timken Company life-calculation method. C₉₀ and C_{a90} are radial and thrust values.

Bearing Dimensions											Geometry Factors			Bearing Weight
Width B	Width C	Eff. Ctr. a ⁽⁴⁾	Shaft			Housing			Cage		G ₁	G ₂	C _g	
			Max Shaft Fillet Radius R ⁽⁵⁾	Backing Shoulder Dia. d _a	mm in.	Max Housing Fillet Radius r ⁽⁵⁾	Backing Shoulder Dia. D _a	mm in.	A _a ⁽⁶⁾	A _b ⁽⁷⁾				
mm in.	mm in.	mm in.	mm in.	mm in.	mm in.	mm in.	mm in.	mm in.	mm in.	mm in.			kg lbs.	
17.462 0.6875	13.495 0.5313	-2.0 -0.08	2.8 0.11	51.0 2.01	56.0 2.20	1.5 0.06	74.0 2.91	71.0 2.80	0.7 0.02	1.6 0.07	23.9	18.7	0.0725	0.32 0.73
17.462 0.6875	14.288 0.5625	0.8 0.03	0.8 0.03	52.0 2.05	52.0 2.05	1.5 0.06	76.0 2.99	72.0 2.83	1.6 0.06	2.0 0.08	23.0	19.2	0.0799	0.37 0.83
25.400 1.0000	19.050 0.7500	-6.4 -0.25	3.5 0.14	52.0 2.05	58.0 2.28	0.8 0.03	77.0 3.03	74.0 2.91	1.0 0.04	0.7 0.03	35.2	14.3	0.0801	0.53 1.17
21.692 0.8540	23.812 0.9375	-4.8 -0.19	2.3 0.09	51.0 2.01	55.0 2.17	3.3 0.13	79.5 3.13	74.0 2.91	0.4 0.01	1.7 0.07	30.0	12.2	0.0732	0.55 1.21
21.692 0.8540	17.462 0.6875	-4.8 -0.19	3.5 0.14	51.0 2.01	57.0 2.24	1.3 0.05	80.0 3.15	77.0 3.03	0.4 0.01	1.7 0.07	30.0	12.2	0.0732	0.48 1.07
21.692 0.8540	17.462 0.6875	-4.8 -0.19	2.3 0.09	51.0 2.01	55.0 2.17	1.3 0.05	80.0 3.15	77.0 3.03	0.4 0.01	1.7 0.07	30.0	12.2	0.0732	0.49 1.08
21.692 0.8540	17.462 0.6875	-4.8 -0.19	2.3 0.09	51.0 2.01	55.0 2.17	1.5 0.06	80.0 3.15	77.0 3.03	0.4 0.01	1.7 0.07	30.0	12.2	0.0732	0.49 1.08
25.608 1.0082	20.638 0.8125	-6.4 -0.25	3.5 0.14	52.0 2.05	58.0 2.28	1.3 0.05	80.0 3.15	76.0 2.99	1.7 0.07	1.1 0.05	38.2	15.7	0.0832	0.61 1.34
25.608 1.0082	20.638 0.8125	-6.4 -0.25	0.8 0.03	52.0 2.05	53.0 2.09	1.3 0.05	80.0 3.15	76.0 2.99	1.7 0.07	1.1 0.05	38.2	15.7	0.0832	0.62 1.35
21.692 0.8540	23.812 0.9375	-4.8 -0.19	2.3 0.09	51.0 2.01	55.0 2.17	3.3 0.13	81.0 3.19	75.0 2.95	0.4 0.01	1.7 0.07	30.0	12.2	0.0732	0.63 1.38
25.608 1.0082	22.225 0.8750	-6.4 -0.25	3.5 0.14	52.0 2.05	58.0 2.28	2.3 0.09	81.0 3.19	75.0 2.95	1.7 0.07	1.1 0.05	38.2	15.7	0.0832	0.68 1.50
21.692 0.8540	21.808 0.8586	-4.8 -0.19	2.3 0.09	51.0 2.01	55.0 2.17	2.3 0.09	81.0 3.19	78.0 3.07	0.4 0.01	1.7 0.07	30.0	12.2	0.0732	0.62 1.36
21.692 0.8540	21.808 0.8586	-4.8 -0.19	2.3 0.09	51.0 2.01	55.0 2.17	2.3 0.09	82.0 3.23	78.0 3.07	0.4 0.01	1.7 0.07	30.0	12.2	0.0732	0.65 1.43
30.302 1.1930	23.812 0.9375	-8.1 -0.32	3.5 0.14	53.0 2.09	60.0 2.36	3.3 0.13	87.9 3.46	82.0 3.23	1.8 0.07	1.0 0.04	49.9	14.5	0.0903	0.94 2.06
29.900 1.1772	22.225 0.8750	-9.1 -0.36	3.5 0.14	52.0 2.05	59.0 2.32	2.3 0.09	87.0 3.43	83.0 3.27	1.6 0.06	0.5 0.02	42.5	11.3	0.0805	0.91 2.00
29.900 1.1772	26.195 1.0313	-9.1 -0.36	3.5 0.14	52.0 2.05	59.0 2.32	3.3 0.13	87.0 3.43	81.0 3.19	1.6 0.06	0.5 0.02	42.5	11.3	0.0805	0.99 2.18
22.225 0.8750	16.513 0.6501	-4.3 -0.17	3.5 0.14	53.0 2.09	60.0 2.36	1.3 0.05	84.0 3.31	81.0 3.19	0.4 0.01	1.1 0.04	33.8	14.0	0.0773	0.56 1.21

⁽⁴⁾Negative value indicates effective center inside cone (inner-ring) backface.

⁽⁵⁾These maximum fillet radii will be cleared by the bearing corners.

⁽⁶⁾Negative value indicates cage extends beyond cone (inner-ring) backface.

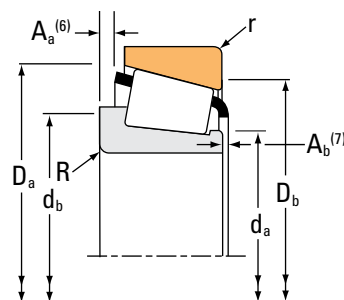
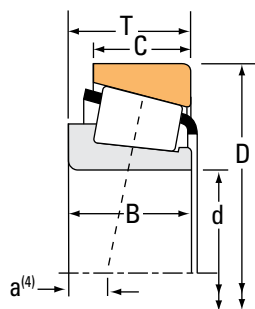
⁽⁷⁾Negative value indicates cage that does not extend beyond cone (inner-ring) front face.

Continued on next page.

TAPERED ROLLER BEARINGS

SINGLE-ROW • TYPE TS

TYPE TS



Bearing Dimensions			Load Ratings							Part Number		
Bore d	O.D. D	Width T	Dynamic ⁽¹⁾		Factors ⁽²⁾		Dynamic ⁽³⁾		Factors ⁽²⁾	Static	Inner	Outer
			C ₁	e	Y	C ₉₀	C _{a90}	K	C ₀			
mm in.	mm in.	mm in.	N lbf			N lbf	N lbf		N lbf			
47.625 1.8750	88.900 3.5000	20.638 0.8125	102000 22900	0.32	1.88	26400 5930	14400 3250	1.83	95800 21500		369-S	362A
47.625 1.8750	88.900 3.5000	25.400 1.0000	98600 22200	0.55	1.10	25600 5740	23900 5370	1.07	116000 26100		M804049	M804010
47.625 1.8750	88.900 3.5000	25.400 1.0000	98600 22200	0.55	1.10	25600 5740	23900 5370	1.07	116000 26100		M804048	M804010
47.625 1.8750	90.000 3.5433	20.000 0.7874	102000 22900	0.32	1.88	26400 5930	14400 3250	1.83	95800 21500		369-S	362
47.625 1.8750	90.000 3.5433	20.000 0.7874	102000 22900	0.32	1.88	26400 5930	14400 3250	1.83	95800 21500		369A	362
47.625 1.8750	93.264 3.6718	30.162 1.1875	122000 27500	0.34	1.77	31700 7120	18300 4120	1.73	153000 34300		3779	3720
47.625 1.8750	93.264 3.6718	30.162 1.1875	122000 27500	0.34	1.77	31700 7120	18300 4120	1.73	153000 34300		3778	3720
47.625 1.8750	93.264 3.6718	30.162 1.1875	122000 27500	0.34	1.77	31700 7120	18300 4120	1.73	153000 34300		3779	3730
47.625 1.8750	95.250 3.7500	30.162 1.1875	122000 27500	0.34	1.77	31700 7120	18300 4120	1.73	153000 34300		3779	3726
47.625 1.8750	95.250 3.7500	30.162 1.1875	147000 33100	0.55	1.10	38200 8590	35700 8030	1.07	157000 35400		HM804846	HM804810
47.625 1.8750	96.838 3.8125	21.000 0.8268	108000 24200	0.35	1.69	28000 6280	16900 3810	1.65	107000 24100		386A	382A
47.625 1.8750	98.425 3.8750	30.162 1.1875	122000 27500	0.34	1.77	31700 7120	18300 4120	1.73	153000 34300		3779	3732
47.625 1.8750	100.000 3.9370	34.925 1.3750	165000 37000	0.29	2.10	42700 9600	20800 4690	2.05	191000 43000		528	520X
47.625 1.8750	101.600 4.0000	31.750 1.2500	133000 29800	0.40	1.50	34400 7740	23600 5310	1.46	155000 35000		49580	49520
47.625 1.8750	101.600 4.0000	34.925 1.3750	165000 37000	0.29	2.10	42700 9600	20800 4690	2.05	191000 43000		528	522
47.625 1.8750	101.600 4.0000	34.925 1.3750	165000 37000	0.29	2.10	42700 9600	20800 4690	2.05	191000 43000		528A	522
47.625 1.8750	101.600 4.0000	34.925 1.3750	133000 29800	0.40	1.50	34400 7740	23600 5310	1.46	155000 35000		49580	49521

⁽¹⁾Based on 1 x 10⁶ revolutions L₁₀ life, for the ISO life-calculation method.

⁽²⁾Consult your Timken engineer for instructions on use or review the Timken Engineering Manual on timken.com/catalogs.

⁽³⁾Based on 90 x 10⁶ revolutions L₁₀ life, for The Timken Company life-calculation method. C₉₀ and C_{a90} are radial and thrust values.

Bearing Dimensions											Geometry Factors			Bearing Weight
Width B	Width C	Eff. Ctr. a ⁽⁴⁾	Shaft			Housing			Cage		G ₁	G ₂	C _g	
			Max Shaft Fillet Radius R ⁽⁵⁾	Backing Shoulder Dia. d _a	Shoulder Dia. d _b	Max Housing Fillet Radius r ⁽⁵⁾	Backing Shoulder Dia. D _a	Shoulder Dia. D _b	A _a ⁽⁶⁾	A _b ⁽⁷⁾				
mm in.	mm in.	mm in.	mm in.	mm in.	mm in.	mm in.	mm in.	mm in.	mm in.	mm in.				kg lbs.
22.225 0.8750	16.513 0.6501	-4.3 -0.17	2.3 0.09	53.0 2.09	57.0 2.24	1.3 0.05	84.0 3.31	81.0 3.19	0.4 0.01	1.1 0.04	33.8	14.0	0.0773	0.56 1.22
25.400 1.0000	19.050 0.7500	-1.8 -0.07	3.5 0.14	56.0 2.20	65.0 2.56	3.3 0.13	85.0 3.35	77.0 3.03	1.6 0.06	2.0 0.08	33.9	12.5	0.0924	0.66 1.45
25.400 1.0000	19.050 0.7500	-1.8 -0.07	0.8 0.03	56.0 2.20	59.0 2.32	3.3 0.13	85.0 3.35	77.0 3.03	1.6 0.06	2.0 0.08	33.9	12.5	0.0924	0.66 1.46
22.225 0.8750	15.875 0.6250	-4.3 -0.17	2.3 0.09	53.0 2.09	57.0 2.24	2.0 0.08	84.0 3.31	81.0 3.19	0.4 0.01	1.1 0.04	33.8	14.0	0.0773	0.56 1.23
22.225 0.8750	15.875 0.6250	-4.3 -0.17	3.5 0.14	53.0 2.09	60.0 2.36	2.0 0.08	84.0 3.31	81.0 3.19	0.4 0.01	1.1 0.04	33.8	14.0	0.0773	0.56 1.23
30.302 1.1930	23.812 0.9375	-8.1 -0.32	3.5 0.14	55.0 2.17	61.0 2.40	3.3 0.13	87.9 3.46	82.0 3.23	1.8 0.07	1.0 0.04	49.9	14.5	0.0903	0.91 2.00
30.302 1.1930	23.812 0.9375	-8.1 -0.32	6.4 0.25	55.0 2.17	67.0 2.64	3.3 0.13	87.9 3.46	82.0 3.23	1.8 0.07	1.0 0.04	49.9	14.5	0.0903	0.89 1.96
30.302 1.1930	23.812 0.9375	-8.1 -0.32	3.5 0.14	55.0 2.17	61.0 2.40	0.8 0.03	88.0 3.46	84.0 3.31	1.8 0.07	1.0 0.04	49.9	14.5	0.0903	0.92 2.01
30.302 1.1930	23.812 0.9375	-8.1 -0.32	3.5 0.14	55.0 2.17	61.0 2.40	3.3 0.13	88.9 3.50	83.1 3.27	1.8 0.07	1.0 0.04	49.9	14.5	0.0903	0.96 2.10
29.370 1.1563	23.020 0.9063	-3.8 -0.15	3.5 0.14	57.0 2.26	66.0 2.60	3.3 0.13	91.0 3.58	81.0 3.19	2.2 0.09	2.8 0.11	44.8	13.8	0.1017	0.97 2.14
21.946 0.8640	15.875 0.6250	-3.0 -0.12	0.8 0.03	55.0 2.17	56.0 2.20	0.8 0.03	92.0 3.62	89.0 3.50	1.1 0.04	2.0 0.08	42.0	15.7	0.0859	0.73 1.60
30.302 1.1930	23.812 0.9375	-8.1 -0.32	3.5 0.14	55.0 2.17	61.0 2.40	3.3 0.13	89.9 3.54	84.1 3.31	1.8 0.07	1.0 0.04	49.9	14.5	0.0903	1.05 2.30
36.068 1.4200	26.988 1.0625	-12.7 -0.50	3.5 0.14	55.0 2.17	62.0 2.44	3.3 0.13	94.0 3.70	88.0 3.46	2.7 0.10	1.8 0.07	57.9	13.4	0.0894	1.24 2.75
31.750 1.2500	25.400 1.0000	-7.1 -0.28	3.5 0.14	56.0 2.20	63.0 2.48	3.3 0.13	96.0 3.78	88.0 3.46	2.3 0.09	1.4 0.06	49.1	16.8	0.0946	1.18 2.60
36.068 1.4200	26.988 1.0625	-12.7 -0.50	3.5 0.14	55.0 2.17	62.0 2.44	3.3 0.13	95.0 3.74	89.0 3.50	2.7 0.10	1.8 0.07	57.9	13.4	0.0894	1.30 2.86
36.068 1.4200	26.988 1.0625	-12.7 -0.50	1.5 0.06	55.0 2.17	58.0 2.28	3.3 0.13	95.0 3.74	89.0 3.50	2.7 0.10	1.8 0.07	57.9	13.4	0.0894	1.30 2.88
31.750 1.2500	28.575 1.1250	-7.1 -0.28	3.5 0.14	56.0 2.20	63.0 2.48	3.3 0.13	96.0 3.78	87.0 3.43	2.3 0.09	1.4 0.06	49.1	16.8	0.0946	1.25 2.76

⁽⁴⁾Negative value indicates effective center inside cone (inner-ring) backface.

⁽⁵⁾These maximum fillet radii will be cleared by the bearing corners.

⁽⁶⁾Negative value indicates cage extends beyond cone (inner-ring) backface.

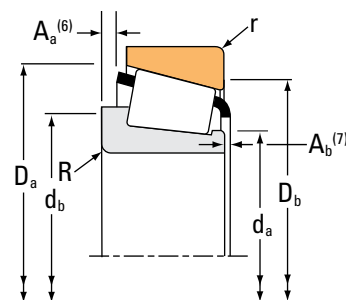
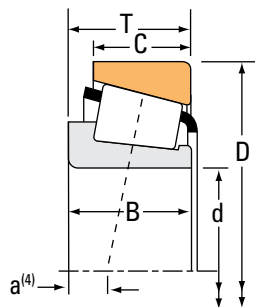
⁽⁷⁾Negative value indicates cage that does not extend beyond cone (inner-ring) front face.

Continued on next page.

TAPERED ROLLER BEARINGS

SINGLE-ROW • TYPE TS

TYPE TS



Bearing Dimensions			Load Ratings							Part Number		
Bore d	O.D. D	Width T	Dynamic ⁽¹⁾		Factors ⁽²⁾		Dynamic ⁽³⁾		Factors ⁽²⁾	Static	Inner	Outer
			C ₁	e	Y	C ₉₀	C _{a90}	K	C ₀			
mm in.	mm in.	mm in.	N lbf			N lbf	N lbf			N lbf		
47.625 1.8750	101.600 4.0000	34.925 1.3750	165000 37000	0.29	2.10	42700 9600	20800 4690	2.05	191000 43000	528R	522	
47.625 1.8750	103.188 4.0625	43.658 1.7188	212000 47700	0.30	2.02	55000 12400	27900 6280	1.97	267000 60100	5361	5335	
47.625 1.8750	103.188 4.0625	43.658 1.7188	212000 47700	0.30	2.02	55000 12400	27900 6280	1.97	267000 60100	5358	5335	
47.625 1.8750	104.775 4.1250	30.162 1.1875	153000 34500	0.33	1.80	39700 8930	22600 5090	1.76	189000 42600	45282	45221	
47.625 1.8750	104.775 4.1250	30.162 1.1875	153000 34500	0.33	1.80	39700 8930	22600 5090	1.76	189000 42600	45282	45220	
47.625 1.8750	104.775 4.1250	36.512 1.4375	202000 45500	0.40	1.49	52400 11800	36100 8110	1.45	202000 45400	59187	59412	
47.625 1.8750	104.775 4.1250	36.512 1.4375	202000 45500	0.40	1.49	52400 11800	36100 8110	1.45	202000 45400	59188	59412	
47.625 1.8750	107.950 4.2500	27.783 1.0938	161000 36100	0.34	1.79	41700 9370	23900 5380	1.74	166000 37200	467	453A	
47.625 1.8750	107.950 4.2500	36.512 1.4375	172000 38700	0.30	2.02	44600 10000	22700 5090	1.97	206000 46200	536	532X	
47.625 1.8750	108.966 4.2900	34.925 1.3750	202000 45500	0.40	1.49	52400 11800	36100 8110	1.45	202000 45400	59187	59429	
47.625 1.8750	108.966 4.2900	34.925 1.3750	202000 45500	0.40	1.49	52400 11800	36100 8110	1.45	202000 45400	59188	59429	
47.625 1.8750	111.125 4.3750	30.162 1.1875	123000 27700	0.88	0.68	31900 7170	48200 10800	0.66	153000 34400	HM907639	HM907614	
47.625 1.8750	111.125 4.3750	30.162 1.1875	151000 34000	0.88	0.68	39200 8810	59300 13300	0.66	161000 36200	55187C	55437	
47.625 1.8750	111.125 4.3750	38.100 1.5000	172000 38700	0.30	2.02	44600 10000	22700 5090	1.97	206000 46200	536	532	
47.625 1.8750	112.712 4.4375	30.162 1.1875	126000 28300	0.88	0.68	32700 7350	49500 11100	0.66	119000 26700	55187	55443	
47.625 1.8750	112.712 4.4375	30.162 1.1875	123000 27700	0.88	0.68	31900 7170	48200 10800	0.66	153000 34400	HM907639	HM907616	
47.625 1.8750	112.712 4.4375	30.162 1.1875	151000 34000	0.88	0.68	39200 8810	59300 13300	0.66	161000 36200	55187C	55443	

⁽¹⁾Based on 1 x 10⁶ revolutions L₁₀ life, for the ISO life-calculation method.

⁽²⁾Consult your Timken engineer for instructions on use or review the Timken Engineering Manual on timken.com/catalogs.

⁽³⁾Based on 90 x 10⁶ revolutions L₁₀ life, for The Timken Company life-calculation method. C₉₀ and C_{a90} are radial and thrust values.

Bearing Dimensions											Geometry Factors			Bearing Weight
Width B	Width C	Eff. Ctr. a ⁽⁴⁾	Shaft			Housing			Cage		G ₁	G ₂	C _g	
			Max Shaft Fillet Radius R ⁽⁵⁾	Backing Shoulder Dia. d _a	Shoulder Dia. d _b	Max Housing Fillet Radius r ⁽⁵⁾	Backing Shoulder Dia. D _a	Shoulder Dia. D _b	A _a ⁽⁶⁾	A _b ⁽⁷⁾				
mm in.	mm in.	mm in.	mm in.	mm in.	mm in.	mm in.	mm in.	mm in.	mm in.	mm in.				kg lbs.
36.068 1.4200	26.988 1.0625	-12.7 -0.50	8.0 0.31	55.0 2.17	70.0 2.76	3.3 0.13	95.0 3.74	89.0 3.50	2.7 0.10	1.8 0.07	57.9	13.4	0.0894	1.26 2.79
44.475 1.7510	36.512 1.4375	-16.0 -0.63	3.5 0.14	58.0 2.28	65.0 2.56	3.3 0.13	97.0 3.82	89.0 3.50	2.5 0.10	1.0 0.04	73.4	15.5	0.0985	1.76 3.88
44.475 1.7510	36.512 1.4375	-16.0 -0.63	1.3 0.05	58.0 2.28	60.0 2.36	3.3 0.13	97.0 3.82	89.0 3.50	2.5 0.10	1.0 0.04	73.4	15.5	0.0985	1.77 3.89
30.958 1.2188	23.812 0.9375	-8.1 -0.32	3.5 0.14	57.0 2.24	63.0 2.48	0.8 0.03	99.0 3.90	95.0 3.74	2.1 0.08	1.8 0.07	63.5	16.9	0.0971	1.27 2.80
30.958 1.2188	23.812 0.9375	-8.1 -0.32	3.5 0.14	57.0 2.24	63.0 2.48	3.3 0.13	99.0 3.90	93.0 3.66	2.1 0.08	1.8 0.07	63.5	16.9	0.0971	1.27 2.79
36.512 1.4375	28.575 1.1250	-9.7 -0.38	3.5 0.14	59.0 2.32	65.0 2.56	3.3 0.13	99.0 3.90	92.0 3.62	3.4 0.13	1.3 0.05	57.3	15.2	0.0999	1.48 3.25
36.512 1.4375	28.575 1.1250	-9.7 -0.38	1.5 0.06	59.0 2.32	61.0 2.40	3.3 0.13	99.0 3.90	92.0 3.62	3.4 0.13	1.3 0.05	57.3	15.2	0.0999	1.48 3.26
29.317 1.1542	22.225 0.8750	-7.1 -0.28	0.8 0.03	56.0 2.20	57.0 2.24	0.8 0.03	100.0 3.94	97.0 3.82	2.1 0.08	1.4 0.06	58.6	17.1	0.0946	1.28 2.83
36.957 1.4550	28.575 1.1250	-12.2 -0.48	3.5 0.14	56.0 2.20	62.0 2.44	3.3 0.13	100.0 3.94	94.0 3.70	2.7 0.10	1.0 0.04	64.3	16.1	0.0938	1.59 3.51
36.512 1.4375	26.988 1.0625	-9.7 -0.38	3.5 0.14	59.0 2.32	65.0 2.56	3.3 0.13	101.0 3.98	93.0 3.66	3.4 0.13	1.3 0.05	57.3	15.2	0.0999	1.59 3.49
36.512 1.4375	26.988 1.0625	-9.7 -0.38	1.5 0.06	59.0 2.32	61.0 2.40	3.3 0.13	101.0 3.98	93.0 3.66	3.4 0.13	1.3 0.05	57.3	15.2	0.0999	1.59 3.51
28.575 1.1250	20.638 0.8125	7.6 0.30	3.5 0.14	65.3 2.56	72.0 2.83	3.3 0.13	105.0 4.13	91.0 3.58	4.6 0.18	2.1 0.08	46.9	17.5	0.1182	1.40 3.08
26.909 1.0594	20.638 0.8125	7.6 0.30	3.5 0.14	62.0 2.44	69.0 2.72	3.3 0.13	105.0 4.13	92.0 3.62	5.0 0.19	3.7 0.15	48.7	18.1	0.1198	1.41 3.10
36.957 1.4550	33.338 1.3125	-12.2 -0.48	3.5 0.14	56.0 2.20	62.0 2.44	3.3 0.13	100.0 3.94	95.0 3.74	2.7 0.10	1.0 0.04	64.3	16.1	0.0938	1.82 4.01
26.909 1.0594	20.638 0.8125	7.1 0.28	3.5 0.14	62.0 2.44	69.0 2.72	3.3 0.13	106.0 4.17	92.0 3.62	4.8 0.18	3.2 0.13	36.8	13.2	0.1085	1.34 2.98
28.575 1.1250	20.638 0.8125	7.6 0.30	3.5 0.14	65.3 2.56	72.0 2.83	3.3 0.13	106.0 4.17	91.0 3.58	4.6 0.18	2.1 0.08	46.9	17.5	0.1182	1.46 3.22
26.909 1.0594	20.638 0.8125	7.6 0.30	3.5 0.14	62.0 2.44	69.0 2.72	3.3 0.13	106.0 4.17	92.0 3.62	5.0 0.19	3.7 0.15	48.7	18.1	0.1198	1.44 3.17

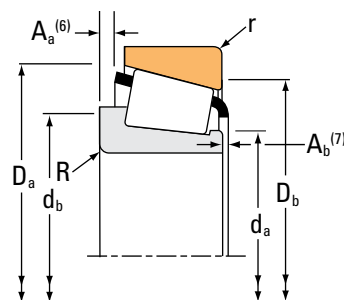
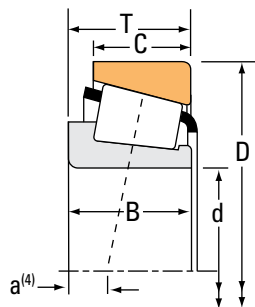
(4) Negative value indicates effective center inside cone (inner-ring) backface.
 (5) These maximum fillet radii will be cleared by the bearing corners.
 (6) Negative value indicates cage extends beyond cone (inner-ring) backface.
 (7) Negative value indicates cage that does not extend beyond cone (inner-ring) front face.

Continued on next page.

TAPERED ROLLER BEARINGS

SINGLE-ROW • TYPE TS

TYPE TS



Bearing Dimensions			Load Ratings							Part Number	
Bore d	O.D. D	Width T	Dynamic ⁽¹⁾ C ₁	Factors ⁽²⁾ e Y		Dynamic ⁽³⁾ C ₉₀	C _{a90}	Factors ⁽²⁾ K	Static C ₀	Inner	Outer
mm in.	mm in.	mm in.	N lbf			N lbf	N lbf		N lbf		
47.625 1.8750	117.475 4.6250	33.338 1.3125	177000 39700	0.63	0.96	45800 10300	49100 11000	0.93	166000 37300	66187	66462
47.625 1.8750	120.650 4.7500	41.275 1.6250	207000 46600	0.31	1.91	53800 12100	28900 6510	1.86	244000 54800	617	612
47.625 1.8750	123.825 4.8750	36.512 1.4375	214000 48200	0.74	0.81	55500 12500	70100 15800	0.79	208000 46800	72188C	72487
47.625 1.8750	123.825 4.8750	36.512 1.4375	214000 48200	0.74	0.81	55500 12500	70100 15800	0.79	208000 46800	72187C	72487
48.412 1.9060	95.250 3.7500	30.162 1.1875	147000 33100	0.55	1.10	38200 8590	35700 8030	1.07	157000 35400	HM804849	HM804810
48.412 1.9060	95.250 3.7500	30.162 1.1875	147000 33100	0.55	1.10	38200 8590	35700 8030	1.07	157000 35400	HM804848	HM804810
48.412 1.9060	95.250 3.7500	30.162 1.1875	147000 33100	0.55	1.10	38200 8590	35700 8030	1.07	157000 35400	HM804848A	HM804810
48.600 1.9134	88.000 3.4646	21.500 0.8465	96300 21700	0.31	1.97	25000 5610	13000 2930	1.91	104000 23400	JLM104942A	JLM104914
49.212 1.9375	88.900 3.5000	20.638 0.8125	102000 22900	0.32	1.88	26400 5930	14400 3250	1.83	95800 21500	365-S	362A
49.212 1.9375	90.000 3.5433	25.001 0.9843	102000 22900	0.32	1.88	26400 5930	14400 3250	1.83	95800 21500	365-S	362X
49.212 1.9375	93.264 3.6718	30.162 1.1875	122000 27500	0.34	1.77	31700 7120	18300 4120	1.73	153000 34300	3781	3720
49.212 1.9375	103.188 4.0625	43.658 1.7188	212000 47700	0.30	2.02	55000 12400	27900 6280	1.97	267000 60100	5395	5335
49.212 1.9375	104.775 4.1250	36.512 1.4375	203000 45700	0.49	1.23	52700 11900	44000 9890	1.20	223000 50200	HM807044	HM807010
49.212 1.9375	114.300 4.5000	44.450 1.7500	224000 50300	0.43	1.39	58000 13000	42700 9600	1.36	256000 57500	65390	65320
49.212 1.9375	114.300 4.5000	44.450 1.7500	246000 55300	0.40	1.49	63700 14300	43800 9860	1.45	290000 65100	HH506348	HH506310
49.212 1.9375	114.300 4.5000	44.450 1.7500	246000 55300	0.40	1.49	63700 14300	43800 9860	1.45	290000 65100	HH506348	HH506311
49.212 1.9375	122.238 4.8125	43.658 1.7188	237000 53200	0.36	1.67	61300 13800	37600 8460	1.63	327000 73500	5562	5535

⁽¹⁾Based on 1 x 10⁶ revolutions L₁₀ life, for the ISO life-calculation method.

⁽²⁾Consult your Timken engineer for instructions on use or review the Timken Engineering Manual on timken.com/catalogs.

⁽³⁾Based on 90 x 10⁶ revolutions L₁₀ life, for The Timken Company life-calculation method. C₉₀ and C_{a90} are radial and thrust values.

Bearing Dimensions											Geometry Factors			Bearing Weight
Width B	Width C	Eff. Ctr. a ⁽⁴⁾	Shaft			Housing			Cage		G ₁	G ₂	C _g	
			Max Shaft Fillet Radius R ⁽⁵⁾	Backing Shoulder Dia. d _a	Shoulder Dia. d _b	Max Housing Fillet Radius r ⁽⁵⁾	Backing Shoulder Dia. D _a	Shoulder Dia. D _b	A _a ⁽⁶⁾	A _b ⁽⁷⁾				
mm in.	mm in.	mm in.	mm in.	mm in.	mm in.	mm in.	mm in.	mm in.	mm in.	mm in.				kg lbs.
31.750 1.2500	23.812 0.9375	-0.3 -0.01	3.5 0.14	62.0 2.44	69.0 2.72	3.3 0.13	111.0 4.37	100.0 3.94	5.0 0.19	2.0 0.08	50.2	16.4	0.0751	1.69 3.74
41.275 1.6250	31.750 1.2500	-14.0 -0.55	3.5 0.14	58.0 2.28	65.0 2.56	3.3 0.13	110.0 4.33	105.0 4.13	3.8 0.15	1.9 0.08	75.9	16.2	0.0694	2.35 5.18
32.791 1.2910	25.400 1.0000	2.0 0.08	0.8 0.03	67.0 2.64	69.0 2.72	3.3 0.13	116.0 4.57	102.0 4.02	4.7 0.18	4.4 0.18	57.4	15.9	0.0825	2.18 4.81
32.791 1.2910	25.400 1.0000	2.0 0.08	3.5 0.14	66.0 2.60	75.0 2.95	3.3 0.13	116.0 4.57	102.0 4.02	4.7 0.18	4.4 0.18	57.4	15.9	0.0825	2.15 4.76
29.370 1.1563	23.020 0.9063	-3.8 -0.15	3.5 0.14	57.0 2.26	66.0 2.60	3.3 0.13	91.0 3.58	81.0 3.19	2.2 0.09	2.8 0.11	44.8	13.8	0.1017	0.96 2.11
29.370 1.1563	23.020 0.9063	-3.8 -0.15	2.3 0.09	57.0 2.26	63.0 2.48	3.3 0.13	91.0 3.58	81.0 3.19	2.2 0.09	2.8 0.11	44.8	13.8	0.1017	0.96 2.12
29.370 1.1563	23.020 0.9063	-3.8 -0.15	2.3 0.09	57.0 2.26	63.0 2.48	3.3 0.13	91.0 3.58	81.0 3.19	2.2 0.09	2.8 0.11	44.8	13.8	0.1017	0.96 2.11
21.500 0.8465	17.000 0.6693	-5.3 -0.21	0.0 0.00	55.0 2.17	54.0 2.13	0.8 0.03	81.0 3.19	78.0 3.07	0.7 0.03	2.2 0.09	38.8	19.3	0.0801	0.56 1.23
22.225 0.8750	16.513 0.6501	-4.3 -0.17	0.8 0.03	54.0 2.13	55.0 2.17	1.3 0.05	84.0 3.31	81.0 3.19	0.4 0.01	1.1 0.04	33.8	14.0	0.0773	0.54 1.17
22.225 0.8750	20.000 0.7874	-4.3 -0.17	0.8 0.03	54.0 2.13	55.0 2.17	2.0 0.08	84.0 3.31	80.0 3.15	0.4 0.01	1.1 0.04	33.8	14.0	0.0773	0.62 1.36
30.302 1.1930	23.812 0.9375	-8.1 -0.32	3.5 0.14	56.0 2.20	62.0 2.44	3.3 0.13	87.9 3.46	82.0 3.23	1.8 0.07	1.0 0.04	49.9	14.5	0.0903	0.88 1.94
44.475 1.7510	36.512 1.4375	-16.0 -0.63	3.5 0.14	60.0 2.36	66.0 2.60	3.3 0.13	97.0 3.82	89.0 3.50	2.5 0.10	1.0 0.04	73.4	15.5	0.0985	1.72 3.78
36.512 1.4375	28.575 1.1250	-7.4 -0.29	3.5 0.14	63.0 2.48	69.0 2.72	3.3 0.13	100.0 3.94	89.0 3.50	3.4 0.13	2.0 0.08	63.9	17.1	0.0760	1.50 3.29
44.450 1.7500	34.925 1.3750	-12.4 -0.49	3.5 0.14	60.0 2.36	70.0 2.76	3.3 0.13	107.0 4.21	97.0 3.82	3.6 0.14	1.1 0.05	63.1	13.0	0.1053	2.19 4.82
44.450 1.7500	36.068 1.4200	-13.5 -0.53	3.5 0.14	61.0 2.40	71.0 2.80	3.3 0.13	107.0 4.21	97.0 3.82	2.7 0.10	3.3 0.13	72.0	15.6	0.1078	2.26 4.97
44.450 1.7500	36.068 1.4200	-13.5 -0.53	3.5 0.14	61.0 2.40	71.0 2.80	0.8 0.03	107.0 4.21	99.0 3.90	2.7 0.10	3.3 0.13	72.0	15.6	0.1078	2.28 5.00
43.764 1.7230	36.512 1.4375	-12.2 -0.48	1.3 0.05	63.0 2.48	65.0 2.56	3.3 0.13	116.0 4.57	106.0 4.17	2.5 0.09	1.3 0.05	110.4	24.2	0.0825	2.72 6.02

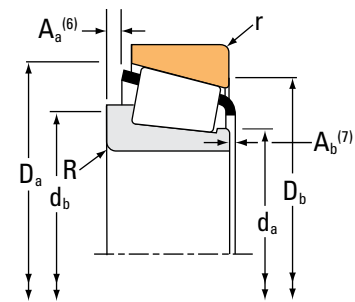
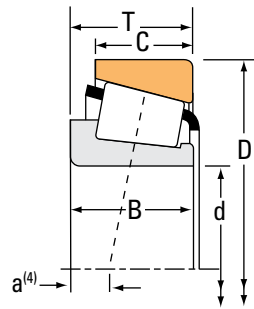
⁽⁴⁾Negative value indicates effective center inside cone (inner-ring) backface.
⁽⁵⁾These maximum fillet radii will be cleared by the bearing corners.
⁽⁶⁾Negative value indicates cage extends beyond cone (inner-ring) backface.
⁽⁷⁾Negative value indicates cage that does not extend beyond cone (inner-ring) front face.

Continued on next page.

TAPERED ROLLER BEARINGS

SINGLE-ROW • TYPE TS

TYPE TS



Bearing Dimensions			Load Ratings							Part Number			
Bore d	O.D. D	Width T	Dynamic ⁽¹⁾		Factors ⁽²⁾		Dynamic ⁽³⁾		Factors ⁽²⁾		Static C ₀	Inner	Outer
			C ₁	e	Y	C ₉₀	C _{a90}	K	N	N			
mm in.	mm in.	mm in.	N lbf			N lbf	N lbf		N lbf				
49.974 1.9675	111.125 4.3750	30.162 1.1875	126000 28300	0.88	0.68	32700 7350	49500 11100	0.66	119000 26700		55196	55437	
49.982 1.9678	107.950 4.2500	36.512 1.4375	172000 38700	0.30	2.02	44600 10000	22700 5090	1.97	206000 46200		546	532X	
49.987 1.9680	79.975 3.1486	18.258 0.7188	60800 13700	0.36	1.69	15800 3540	9590 2160	1.64	88800 20000		L305648	L305611	
49.987 1.9680	80.962 3.1875	18.258 0.7188	60800 13700	0.36	1.69	15800 3540	9590 2160	1.64	88800 20000		L305648	L305610	
49.987 1.9680	82.000 3.2283	21.976 0.8652	96300 21700	0.31	1.97	25000 5610	13000 2930	1.91	104000 23400		LM104947A	JLM104910	
49.987 1.9680	89.980 3.5425	24.750 0.9744	98900 22200	0.38	1.59	25700 5770	16600 3720	1.55	130000 29200		28579	28520	
49.987 1.9680	92.075 3.6250	24.608 0.9688	98900 22200	0.38	1.59	25700 5770	16600 3720	1.55	130000 29200		28579	28521	
49.987 1.9680	96.838 3.8125	22.225 0.8750	87900 19800	0.34	1.77	22800 5120	13200 2970	1.73	101000 22700		378A	372A	
49.987 1.9680	114.300 4.5000	44.450 1.7500	246000 55300	0.40	1.49	63700 14300	43800 9860	1.45	290000 65100		HH506349	HH506311	
50.000 1.9685	82.000 3.2283	21.500 0.8465	96300 21700	0.31	1.97	25000 5610	13000 2930	1.91	104000 23400		JLM104948	JLM104910	
50.000 1.9685	82.550 3.2500	21.115 0.8313	96300 21700	0.31	1.97	25000 5610	13000 2930	1.91	104000 23400		JLM104948	LM104911	
50.000 1.9685	82.550 3.2500	23.147 0.9113	96300 21700	0.31	1.97	25000 5610	13000 2930	1.91	104000 23400		JLM104948	LM104911A	
50.000 1.9685	82.931 3.2650	21.115 0.8313	96300 21700	0.31	1.97	25000 5610	13000 2930	1.91	104000 23400		JLM104948	LM104912	
50.000 1.9685	84.000 3.3071	22.000 0.8661	96500 21700	0.44	1.37	25000 5620	18700 4210	1.34	104000 23500		JLM704649	JLM704610	
50.000 1.9685	88.900 3.5000	20.638 0.8125	102000 22900	0.32	1.88	26400 5930	14400 3250	1.83	95800 21500		366	362A	
50.000 1.9685	88.900 3.5000	20.638 0.8125	102000 22900	0.32	1.88	26400 5930	14400 3250	1.83	95800 21500		365	362A	
50.000 1.9685	90.000 3.5433	20.000 0.7874	102000 22900	0.32	1.88	26400 5930	14400 3250	1.83	95800 21500		366	362	

⁽¹⁾Based on 1 x 10⁶ revolutions L₁₀ life, for the ISO life-calculation method.

⁽²⁾Consult your Timken engineer for instructions on use or review the Timken Engineering Manual on timken.com/catalogs.

⁽³⁾Based on 90 x 10⁶ revolutions L₁₀ life, for The Timken Company life-calculation method. C₉₀ and C_{a90} are radial and thrust values.

Bearing Dimensions											Geometry Factors			Bearing Weight
Width B	Width C	Eff. Ctr. a ⁽⁴⁾	Shaft			Housing			Cage		G ₁	G ₂	C _g	
			Max Shaft Fillet Radius R ⁽⁵⁾	Backing Shoulder Dia. d _a	Backing Shoulder Dia. d _b	Max Housing Fillet Radius r ⁽⁵⁾	Backing Shoulder Dia. D _a	Backing Shoulder Dia. D _b	A _a ⁽⁶⁾	A _b ⁽⁷⁾				
mm in.	mm in.	mm in.	mm in.	mm in.	mm in.	mm in.	mm in.	mm in.	mm in.	mm in.				kg lbs.
26.909 1.0594	20.638 0.8125	7.1 0.28	3.5 0.14	63.9 2.51	71.0 2.80	3.3 0.13	105.0 4.13	92.0 3.62	4.8 0.18	3.2 0.13	36.8	13.2	0.1085	1.28 2.82
36.957 1.4550	28.575 1.1250	-12.2 -0.48	3.5 0.14	58.0 2.28	65.0 2.56	3.3 0.13	100.0 3.94	94.0 3.70	2.7 0.10	1.0 0.04	64.3	16.1	0.0938	1.54 3.40
18.258 0.7188	14.288 0.5625	-2.5 -0.10	1.5 0.06	55.0 2.17	57.0 2.24	1.5 0.06	76.0 2.99	73.0 2.87	0.2 0.01	2.0 0.08	38.8	29.8	0.0841	0.34 0.76
18.258 0.7188	14.288 0.5625	-2.5 -0.10	1.5 0.06	55.0 2.17	57.0 2.24	1.5 0.06	77.0 3.03	73.0 2.87	0.2 0.01	2.0 0.08	38.8	29.8	0.0841	0.36 0.79
22.225 0.8750	17.000 0.6693	-5.8 -0.23	0.5 0.02	55.0 2.17	55.0 2.17	0.5 0.02	78.0 3.07	76.0 2.99	1.1 0.04	2.0 0.08	38.8	19.3	0.0801	0.44 0.97
25.400 1.0000	19.987 0.7869	-4.8 -0.19	2.3 0.09	56.0 2.20	60.0 2.36	2.3 0.09	86.0 3.39	81.0 3.19	1.4 0.05	1.1 0.05	46.4	18.9	0.0912	0.66 1.46
25.400 1.0000	19.845 0.7813	-4.8 -0.19	2.3 0.09	56.0 2.20	60.0 2.36	0.8 0.03	87.0 3.43	83.0 3.27	1.4 0.05	1.1 0.05	46.4	18.9	0.0912	0.70 1.57
22.225 0.8750	19.050 0.7500	-3.8 -0.15	2.3 0.09	56.0 2.20	60.0 2.36	1.5 0.06	90.0 3.54	86.0 3.39	0.8 0.03	1.5 0.06	37.6	15.4	0.0816	0.72 1.60
44.450 1.7500	36.068 1.4200	-13.5 -0.53	3.5 0.14	61.0 2.40	72.0 2.83	0.8 0.03	107.0 4.21	99.0 3.90	2.7 0.10	3.3 0.13	72.0	15.6	0.1078	2.25 4.96
21.500 0.8465	17.000 0.6693	-5.3 -0.21	3.0 0.12	55.0 2.17	61.0 2.40	0.5 0.02	78.0 3.07	76.0 2.99	0.7 0.03	2.2 0.09	38.8	19.3	0.0801	0.42 0.94
21.500 0.8465	16.510 0.6500	-5.3 -0.21	3.0 0.12	55.0 2.17	61.0 2.40	1.3 0.05	78.0 3.07	75.0 2.95	0.7 0.03	2.2 0.09	38.8	19.3	0.0801	0.42 0.94
21.500 0.8465	18.542 0.7300	-5.3 -0.21	3.0 0.12	55.0 2.17	61.0 2.40	0.8 0.03	78.0 3.07	75.0 2.95	0.7 0.03	2.2 0.09	38.8	19.3	0.0801	0.45 1.00
21.500 0.8465	16.510 0.6500	-5.3 -0.21	3.0 0.12	55.0 2.17	61.0 2.40	1.3 0.05	78.0 3.06	75.0 2.95	0.7 0.03	2.2 0.09	38.8	19.3	0.0801	0.43 0.96
22.000 0.8661	17.500 0.6890	-2.3 -0.09	3.5 0.14	56.0 2.20	64.0 2.52	1.5 0.06	80.0 3.15	76.0 2.99	1.1 0.04	1.6 0.07	35.6	16.7	0.0876	0.46 1.03
22.225 0.8750	16.513 0.6501	-4.3 -0.17	2.3 0.09	55.0 2.17	59.0 2.32	1.3 0.05	84.0 3.31	81.0 3.19	0.4 0.01	1.1 0.04	33.8	14.0	0.0773	0.53 1.15
22.225 0.8750	16.513 0.6501	-4.3 -0.17	2.0 0.08	55.0 2.17	58.0 2.28	1.3 0.05	84.0 3.31	81.0 3.19	0.4 0.01	1.1 0.04	33.8	14.0	0.0773	0.53 1.15
22.225 0.8750	15.875 0.6250	-4.3 -0.17	2.3 0.09	55.0 2.17	59.0 2.32	2.0 0.08	84.0 3.31	81.0 3.19	0.4 0.01	1.1 0.04	33.8	14.0	0.0773	0.53 1.16

⁽⁴⁾Negative value indicates effective center inside cone (inner-ring) backface.

⁽⁵⁾These maximum fillet radii will be cleared by the bearing corners.

⁽⁶⁾Negative value indicates cage extends beyond cone (inner-ring) backface.

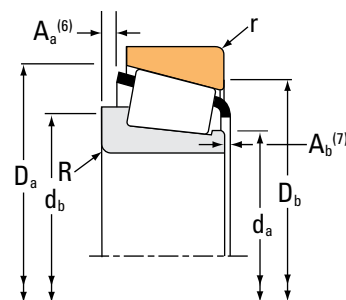
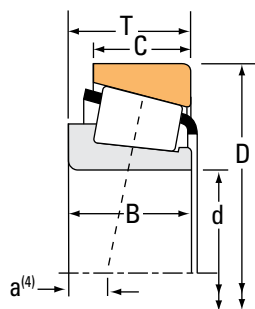
⁽⁷⁾Negative value indicates cage that does not extend beyond cone (inner-ring) front face.

Continued on next page.

TAPERED ROLLER BEARINGS

SINGLE-ROW • TYPE TS

TYPE TS



Bearing Dimensions			Load Ratings							Part Number			
Bore d	O.D. D	Width T	Dynamic ⁽¹⁾		Factors ⁽²⁾		Dynamic ⁽³⁾		Factors ⁽²⁾		Static C ₀	Inner	Outer
			C ₁	e	Y	C ₉₀	C _{a90}	K	N	N			
mm in.	mm in.	mm in.	N lbf			N lbf	N lbf		N lbf				
50.000 1.9685	90.000 3.5433	20.000 0.7874	102000 22900	0.32	1.88	26400 5930	14400 3250	1.83	95800 21500			366	363
50.000 1.9685	90.000 3.5433	20.000 0.7874	102000 22900	0.32	1.88	26400 5930	14400 3250	1.83	95800 21500			365	363
50.000 1.9685	90.000 3.5433	20.000 0.7874	102000 22900	0.32	1.88	26400 5930	14400 3250	1.83	95800 21500			365	362
50.000 1.9685	90.000 3.5433	28.000 1.1024	147000 33000	0.33	1.82	38000 8540	21400 4810	1.78	154000 34600			JM205149	JM205110
50.000 1.9685	90.000 3.5433	28.000 1.1024	147000 33000	0.33	1.82	38000 8540	21400 4810	1.78	154000 34600			JM205149A	JM205110
50.000 1.9685	90.000 3.5433	28.000 1.1024	147000 33000	0.33	1.82	38000 8540	21400 4810	1.78	154000 34600			JM205149	JM205110A
50.000 1.9685	90.000 3.5433	28.000 1.1024	147000 33000	0.33	1.82	38000 8540	21400 4810	1.78	154000 34600			JM205149AS	JM205110
50.000 1.9685	105.000 4.1339	32.000 1.2598	142000 31800	0.87	0.69	36700 8250	54400 12200	0.67	138000 31000			JW5049	JW5010
50.000 1.9685	105.000 4.1339	37.000 1.4567	203000 45700	0.49	1.23	52700 11900	44000 9890	1.20	223000 50200			JHM807045	JHM807012
50.800 2.0000	77.788 3.0625	12.700 0.5000	37300 8390	0.34	1.78	9680 2180	5570 1250	1.74	47200 10600			LL205449	LL205410
50.800 2.0000	80.962 3.1875	18.258 0.7188	60800 13700	0.36	1.69	15800 3540	9590 2160	1.64	88800 20000			L305649	L305610
50.800 2.0000	82.000 3.2283	21.976 0.8652	96300 21700	0.31	1.97	25000 5610	13000 2930	1.91	104000 23400			LM104949	JLM104910
50.800 2.0000	82.550 3.2500	21.590 0.8500	96300 21700	0.31	1.97	25000 5610	13000 2930	1.91	104000 23400			LM104949	LM104911
50.800 2.0000	82.550 3.2500	23.622 0.9300	96300 21700	0.31	1.97	25000 5610	13000 2930	1.91	104000 23400			LM104949	LM104911A
50.800 2.0000	82.931 3.2650	21.590 0.8500	96300 21700	0.31	1.97	25000 5610	13000 2930	1.91	104000 23400			LM104949	LM104912
50.800 2.0000	83.312 3.2800	17.462 0.6875	54700 12300	0.41	1.48	14200 3190	9840 2210	1.44	67500 15200			18790	18721
50.800 2.0000	85.000 3.3465	17.462 0.6875	54700 12300	0.41	1.48	14200 3190	9840 2210	1.44	67500 15200			18790	18720

⁽¹⁾Based on 1 x 10⁶ revolutions L₁₀ life, for the ISO life-calculation method.

⁽²⁾Consult your Timken engineer for instructions on use or review the Timken Engineering Manual on timken.com/catalogs.

⁽³⁾Based on 90 x 10⁶ revolutions L₁₀ life, for The Timken Company life-calculation method. C₉₀ and C_{a90} are radial and thrust values.

Bearing Dimensions											Geometry Factors			Bearing Weight
Width B	Width C	Eff. Ctr. a ⁽⁴⁾	Shaft			Housing			Cage		G ₁	G ₂	C _g	
			Max Shaft Fillet Radius R ⁽⁵⁾	Backing Shoulder Dia. d _a d _b		Max Housing Fillet Radius r ⁽⁵⁾	Backing Shoulder Dia. D _a D _b		A _a ⁽⁶⁾	A _b ⁽⁷⁾				
mm in.	mm in.	mm in.	mm in.	mm in.	mm in.	mm in.	mm in.	mm in.	mm in.	mm in.				kg lbs.
22.225 0.8750	20.000 0.7874	-4.3 -0.17	2.3 0.09	55.0 2.17	59.0 2.32	0.8 0.03	84.7 3.34	82.0 3.23	0.4 0.01	1.1 0.04	33.8	14.0	0.0773	0.56 1.24
22.225 0.8750	20.000 0.7874	-4.3 -0.17	2.0 0.08	55.0 2.17	58.0 2.28	0.8 0.03	84.7 3.34	82.0 3.23	0.4 0.01	1.1 0.04	33.8	14.0	0.0773	0.56 1.24
22.225 0.8750	15.875 0.6250	-4.3 -0.17	2.0 0.08	55.0 2.17	58.0 2.28	2.0 0.08	84.0 3.31	81.0 3.19	0.4 0.01	1.1 0.04	33.8	14.0	0.0773	0.53 1.16
28.000 1.1024	23.000 0.9055	-7.6 -0.30	3.0 0.12	57.0 2.24	63.0 2.48	2.5 0.10	85.0 3.35	80.0 3.15	0.8 0.03	2.3 0.09	48.2	15.2	0.0885	0.74 1.64
28.000 1.1024	23.000 0.9055	-7.6 -0.30	5.0 0.20	57.0 2.24	67.0 2.64	2.5 0.10	85.0 3.35	80.0 3.15	0.8 0.03	2.3 0.09	48.2	15.2	0.0885	0.74 1.63
28.000 1.1024	23.000 0.9055	-7.6 -0.30	3.0 0.12	57.0 2.24	63.0 2.48	0.8 0.03	85.0 3.35	81.0 3.19	0.8 0.03	2.3 0.09	48.2	15.2	0.0885	0.74 1.64
28.000 1.1024	23.000 0.9055	-7.6 -0.30	2.5 0.10	57.0 2.24	63.0 2.48	2.5 0.10	85.0 3.35	80.0 3.15	0.8 0.03	2.3 0.09	48.2	15.2	0.0885	0.74 1.64
29.000 1.1417	22.000 0.8661	4.3 0.17	3.0 0.12	60.0 2.36	76.0 2.99	3.0 0.12	100.0 3.94	86.0 3.39	4.9 0.19	3.6 0.15	39.0	14.6	0.1105	1.23 2.72
36.000 1.4173	29.000 1.1417	-7.6 -0.30	3.0 0.12	63.0 2.48	69.0 2.72	2.5 0.10	100.0 3.94	90.0 3.54	3.5 0.14	2.6 0.11	63.9	17.1	0.0760	1.50 3.28
12.700 0.5000	9.525 0.3750	0.0 0.00	1.5 0.06	55.0 2.17	57.0 2.24	1.5 0.06	74.0 2.91	71.0 2.80	0.2 0.00	1.7 0.07	24.2	29.1	0.0699	0.20 0.44
18.258 0.7188	14.288 0.5625	-2.5 -0.10	1.5 0.06	56.0 2.20	58.0 2.28	1.5 0.06	77.0 3.03	73.0 2.87	0.2 0.01	2.0 0.08	38.8	29.8	0.0841	0.35 0.77
22.225 0.8750	17.000 0.6693	-5.8 -0.23	3.5 0.14	56.0 2.20	63.0 2.48	0.5 0.02	78.0 3.07	76.0 2.99	1.1 0.04	2.0 0.08	38.8	19.3	0.0801	0.42 0.93
22.225 0.8750	16.510 0.6500	-5.8 -0.23	3.5 0.14	56.0 2.20	63.0 2.48	1.3 0.05	78.0 3.07	75.0 2.95	1.1 0.04	2.0 0.08	38.8	19.3	0.0801	0.42 0.93
22.225 0.8750	18.542 0.7300	-5.8 -0.23	3.5 0.14	56.0 2.20	63.0 2.48	0.8 0.03	78.0 3.07	75.0 2.95	1.1 0.04	2.0 0.08	38.8	19.3	0.0801	0.45 0.99
22.225 0.8750	16.510 0.6500	-5.8 -0.23	3.5 0.14	56.0 2.20	63.0 2.48	1.3 0.05	78.0 3.06	75.0 2.95	1.1 0.04	2.0 0.08	38.8	19.3	0.0801	0.43 0.95
17.462 0.6875	13.495 0.5313	-0.8 -0.03	3.5 0.14	56.0 2.20	62.0 2.44	0.8 0.03	79.0 3.11	77.0 3.03	0.8 0.03	1.6 0.07	28.6	23.4	0.0789	0.34 0.76
17.462 0.6875	13.495 0.5313	-0.8 -0.03	3.5 0.14	56.0 2.20	62.0 2.44	1.5 0.06	80.0 3.15	77.0 3.03	0.8 0.03	1.6 0.07	28.6	23.4	0.0789	0.36 0.81

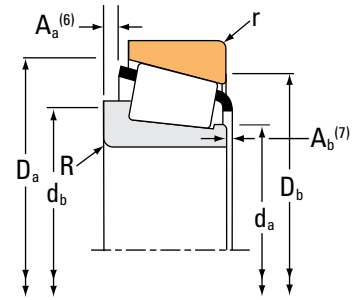
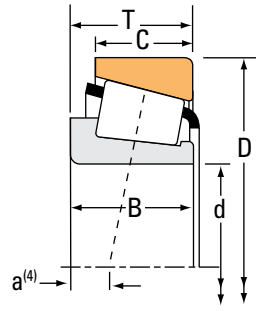
⁽⁴⁾Negative value indicates effective center inside cone (inner-ring) backface.
⁽⁵⁾These maximum fillet radii will be cleared by the bearing corners.
⁽⁶⁾Negative value indicates cage extends beyond cone (inner-ring) backface.
⁽⁷⁾Negative value indicates cage that does not extend beyond cone (inner-ring) front face.

Continued on next page.

TAPERED ROLLER BEARINGS

SINGLE-ROW • TYPE TS

TYPE TS



Bearing Dimensions			Load Ratings							Part Number		
Bore d	O.D. D	Width T	Dynamic ⁽¹⁾		Factors ⁽²⁾		Dynamic ⁽³⁾		Factors ⁽²⁾	Static	Inner	Outer
			C ₁	e	Y	C ₉₀	C _{a90}	K	C ₀			
mm in.	mm in.	mm in.	N lbf			N lbf	N lbf			N lbf		
50.800 2.0000	85.725 3.3750	19.050 0.7500	61100 13700	0.57	1.06	15800 3560	15400 3470	1.03		63900 14400	18200	18337
50.800 2.0000	88.900 3.5000	17.462 0.6875	54700 12300	0.41	1.48	14200 3190	9840 2210	1.44		67500 15200	18790	18724
50.800 2.0000	88.900 3.5000	20.638 0.8125	102000 22900	0.32	1.88	26400 5930	14400 3250	1.83		95800 21500	368A	362A
50.800 2.0000	88.900 3.5000	20.638 0.8125	102000 22900	0.32	1.88	26400 5930	14400 3250	1.83		95800 21500	368	362A
50.800 2.0000	88.900 3.5000	20.638 0.8125	54700 12300	0.41	1.48	14200 3190	9840 2210	1.44		67500 15200	18790	18723
50.800 2.0000	88.900 3.5000	20.638 0.8125	102000 22900	0.32	1.88	26400 5930	14400 3250	1.83		95800 21500	370A	362A
50.800 2.0000	88.900 3.5000	23.812 0.9375	102000 22900	0.32	1.88	26400 5930	14400 3250	1.83		95800 21500	368A	362AX
50.800 2.0000	89.980 3.5425	24.750 0.9744	98900 22200	0.38	1.59	25700 5770	16600 3720	1.55		130000 29200	28580	28520
50.800 2.0000	90.000 3.5433	20.000 0.7874	102000 22900	0.32	1.88	26400 5930	14400 3250	1.83		95800 21500	368	362
50.800 2.0000	90.000 3.5433	20.000 0.7874	102000 22900	0.32	1.88	26400 5930	14400 3250	1.83		95800 21500	368A	362
50.800 2.0000	90.000 3.5433	20.000 0.7874	102000 22900	0.32	1.88	26400 5930	14400 3250	1.83		95800 21500	368	363
50.800 2.0000	90.000 3.5433	20.000 0.7874	102000 22900	0.32	1.88	26400 5930	14400 3250	1.83		95800 21500	370A	362
50.800 2.0000	92.075 3.6250	24.608 0.9688	98900 22200	0.38	1.59	25700 5770	16600 3720	1.55		130000 29200	28580	28521
50.800 2.0000	92.075 3.6250	27.780 1.0937	98900 22200	0.38	1.59	25700 5770	16600 3720	1.55		130000 29200	28580	28523
50.800 2.0000	93.264 3.6718	20.638 0.8125	104000 23400	0.34	1.77	27000 6070	15700 3520	1.73		101000 22700	375	374
50.800 2.0000	93.264 3.6718	20.638 0.8125	104000 23400	0.34	1.77	27000 6070	15700 3520	1.73		101000 22700	375-S	374
50.800 2.0000	93.264 3.6718	26.988 1.0625	104000 23400	0.34	1.77	27000 6070	15700 3520	1.73		101000 22700	375	3720

⁽¹⁾Based on 1 x 10⁶ revolutions L₁₀ life, for the ISO life-calculation method.

⁽²⁾Consult your Timken engineer for instructions on use or review the Timken Engineering Manual on timken.com/catalogs.

⁽³⁾Based on 90 x 10⁶ revolutions L₁₀ life, for The Timken Company life-calculation method. C₉₀ and C_{a90} are radial and thrust values.

Bearing Dimensions											Geometry Factors			Bearing Weight
Width B	Width C	Eff. Ctr. a ⁽⁴⁾	Shaft			Housing			Cage		G ₁	G ₂	C _g	
			Max Shaft Fillet Radius R ⁽⁵⁾	Backing Shoulder Dia. d _a d _b		Max Housing Fillet Radius r ⁽⁵⁾	Backing Shoulder Dia. D _a D _b		A _a ⁽⁶⁾	A _b ⁽⁷⁾				
mm in.	mm in.	mm in.	mm in.	mm in.	mm in.	mm in.	mm in.	mm in.	mm in.	mm in.				kg lbs.
18.263 0.7190	12.700 0.5000	2.0 0.08	1.5 0.06	56.0 2.20	59.0 2.32	1.5 0.06	81.0 3.19	76.0 2.99	* *	* *	26.1	22.1	0.0852	0.39 0.87
17.462 0.6875	13.495 0.5313	-0.8 -0.03	3.5 0.14	56.0 2.20	62.0 2.44	1.3 0.05	82.0 3.23	78.0 3.07	0.8 0.03	1.6 0.07	28.6	23.4	0.0789	0.42 0.93
22.225 0.8750	16.513 0.6501	-4.3 -0.17	3.5 0.14	56.0 2.20	62.0 2.44	1.3 0.05	84.0 3.31	81.0 3.19	0.4 0.01	1.1 0.05	33.8	14.0	0.0773	0.51 1.11
22.225 0.8750	16.513 0.6501	-4.3 -0.17	1.5 0.06	56.0 2.20	58.0 2.28	1.3 0.05	84.0 3.31	81.0 3.19	0.4 0.01	1.1 0.04	33.8	14.0	0.0773	0.51 1.12
17.462 0.6875	16.670 0.6563	-0.8 -0.03	3.5 0.14	56.0 2.20	62.0 2.44	1.3 0.05	82.0 3.23	78.0 3.07	0.8 0.03	1.6 0.07	28.6	23.4	0.0789	0.48 1.06
22.225 0.8750	16.513 0.6501	-4.3 -0.17	5.0 0.20	56.0 2.20	65.0 2.56	1.3 0.05	84.0 3.31	81.0 3.19	0.4 0.01	1.1 0.04	33.8	14.0	0.0773	0.50 1.09
22.225 0.8750	19.688 0.7751	-4.3 -0.17	3.5 0.14	56.0 2.20	62.0 2.44	1.3 0.05	84.0 3.31	80.0 3.15	0.4 0.01	1.1 0.05	33.8	14.0	0.0773	0.55 1.21
25.400 1.0000	19.987 0.7869	-4.8 -0.19	3.5 0.14	57.0 2.24	63.0 2.48	2.3 0.09	86.0 3.39	81.0 3.19	1.4 0.05	1.1 0.05	46.4	18.9	0.0912	0.66 1.45
22.225 0.8750	15.875 0.6250	-4.3 -0.17	1.5 0.06	56.0 2.20	58.0 2.28	2.0 0.08	84.0 3.31	81.0 3.19	0.4 0.01	1.1 0.04	33.8	14.0	0.0773	0.51 1.14
22.225 0.8750	15.875 0.6250	-4.3 -0.17	3.5 0.14	56.0 2.20	62.0 2.44	2.0 0.08	84.0 3.31	81.0 3.19	0.4 0.01	1.1 0.05	33.8	14.0	0.0773	0.51 1.12
22.225 0.8750	20.000 0.7874	-4.3 -0.17	1.5 0.06	56.0 2.20	58.0 2.28	0.8 0.03	84.7 3.34	82.0 3.23	0.4 0.01	1.1 0.04	33.8	14.0	0.0773	0.54 1.21
22.225 0.8750	15.875 0.6250	-4.3 -0.17	5.0 0.20	56.0 2.20	65.0 2.56	2.0 0.08	84.0 3.31	81.0 3.19	0.4 0.01	1.1 0.04	33.8	14.0	0.0773	0.50 1.10
25.400 1.0000	19.845 0.7813	-4.8 -0.19	3.5 0.14	57.0 2.24	63.0 2.48	0.8 0.03	87.0 3.43	83.0 3.27	1.4 0.05	1.1 0.05	46.4	18.9	0.0912	0.70 1.55
25.400 1.0000	23.017 0.9062	-4.8 -0.19	3.5 0.14	57.0 2.24	63.0 2.48	2.3 0.09	87.0 3.43	81.0 3.19	1.4 0.05	1.1 0.05	46.4	18.9	0.0912	0.76 1.67
22.225 0.8750	15.083 0.5938	-3.8 -0.15	2.3 0.09	57.0 2.24	60.0 2.36	1.3 0.05	88.0 3.46	85.0 3.35	0.8 0.03	1.5 0.06	37.6	15.4	0.0816	0.59 1.31
22.225 0.8750	15.083 0.5938	-3.8 -0.15	3.5 0.14	57.0 2.24	63.0 2.48	1.3 0.05	88.0 3.46	85.0 3.35	0.8 0.03	1.5 0.06	37.6	15.4	0.0816	0.59 1.30
22.225 0.8750	23.812 0.9375	-3.8 -0.15	2.3 0.09	57.0 2.24	60.0 2.36	3.3 0.13	87.9 3.46	82.0 3.23	0.8 0.03	1.5 0.06	37.6	15.4	0.0816	0.71 1.57

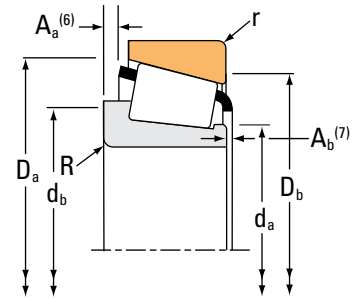
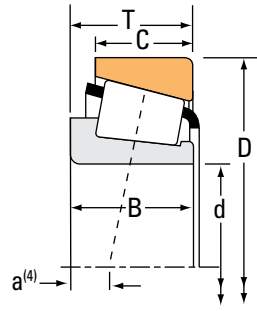
(4) Negative value indicates effective center inside cone (inner-ring) backface.
 (5) These maximum fillet radii will be cleared by the bearing corners.
 (6) Negative value indicates cage extends beyond cone (inner-ring) backface.
 (7) Negative value indicates cage that does not extend beyond cone (inner-ring) front face.
 (*) Contact your Timken engineer for details.

Continued on next page.

TAPERED ROLLER BEARINGS

SINGLE-ROW • TYPE TS

TYPE TS



Bearing Dimensions			Load Ratings							Part Number			
Bore d	O.D. D	Width T	Dynamic ⁽¹⁾		Factors ⁽²⁾		Dynamic ⁽³⁾		Factors ⁽²⁾		Static C ₀	Inner	Outer
			C ₁	e	Y	C ₉₀	C _{a90}	K	N	N			
mm in.	mm in.	mm in.	N lbf			N lbf	N lbf		N lbf				
50.800 2.0000	93.264 3.6718	26.988 1.0625	104000 23400	0.34	1.77	27000 6070	15700 3520	1.73	101000 22700			375	3730
50.800 2.0000	93.264 3.6718	30.162 1.1875	122000 27500	0.34	1.77	31700 7120	18300 4120	1.73	153000 34300			3780	3720
50.800 2.0000	93.264 3.6718	30.162 1.1875	122000 27500	0.34	1.77	31700 7120	18300 4120	1.73	153000 34300			3775	3720
50.800 2.0000	93.264 3.6718	30.162 1.1875	122000 27500	0.34	1.77	31700 7120	18300 4120	1.73	153000 34300			3784	3720
50.800 2.0000	93.264 3.6718	30.162 1.1875	122000 27500	0.34	1.77	31700 7120	18300 4120	1.73	153000 34300			3780	3730
50.800 2.0000	93.662 3.6875	30.162 1.1875	122000 27500	0.34	1.77	31700 7120	18300 4120	1.73	153000 34300			3784	3727
50.800 2.0000	95.250 3.7500	27.783 1.0938	130000 29200	0.33	1.82	33600 7560	19000 4270	1.77	161000 36200			33889	33821
50.800 2.0000	95.250 3.7500	27.783 1.0938	130000 29200	0.33	1.82	33600 7560	19000 4270	1.77	161000 36200			33889	33822
50.800 2.0000	95.250 3.7500	30.162 1.1875	122000 27500	0.34	1.77	31700 7120	18300 4120	1.73	153000 34300			3780	3726
50.800 2.0000	96.838 3.8125	21.000 0.8268	108000 24200	0.35	1.69	28000 6280	16900 3810	1.65	107000 24100			385A	382A
50.800 2.0000	96.838 3.8125	22.225 0.8750	104000 23400	0.34	1.77	27000 6070	15700 3520	1.73	101000 22700			375-S	372A
50.800 2.0000	96.838 3.8125	22.225 0.8750	104000 23400	0.34	1.77	27000 6070	15700 3520	1.73	101000 22700			375	372A
50.800 2.0000	96.838 3.8125	25.400 1.0000	108000 24200	0.35	1.69	28000 6280	16900 3810	1.65	107000 24100			385A	382-S
50.800 2.0000	98.425 3.8750	21.000 0.8268	108000 24200	0.35	1.69	28000 6280	16900 3810	1.65	107000 24100			385A	382
50.800 2.0000	98.425 3.8750	30.162 1.1875	122000 27500	0.34	1.77	31700 7120	18300 4120	1.73	153000 34300			3780	3732
50.800 2.0000	100.000 3.9370	21.000 0.8268	108000 24200	0.35	1.69	28000 6280	16900 3810	1.65	107000 24100			385A	383A
50.800 2.0000	100.000 3.9370	24.999 0.9842	104000 23400	0.34	1.77	27000 6070	15700 3520	1.73	101000 22700			375	372

⁽¹⁾Based on 1 x 10⁶ revolutions L₁₀ life, for the ISO life-calculation method.

⁽²⁾Consult your Timken engineer for instructions on use or review the Timken Engineering Manual on timken.com/catalogs.

⁽³⁾Based on 90 x 10⁶ revolutions L₁₀ life, for The Timken Company life-calculation method. C₉₀ and C_{a90} are radial and thrust values.

Bearing Dimensions											Geometry Factors			Bearing Weight
Width B	Width C	Eff. Ctr. a ⁽⁴⁾	Shaft			Housing			Cage		G ₁	G ₂	C _g	
			Max Shaft Fillet Radius R ⁽⁵⁾	Backing Shoulder Dia. d _a	Backing Shoulder Dia. d _b	Max Housing Fillet Radius r ⁽⁵⁾	Backing Shoulder Dia. D _a	Backing Shoulder Dia. D _b	A _a ⁽⁶⁾	A _b ⁽⁷⁾				
mm in.	mm in.	mm in.	mm in.	mm in.	mm in.	mm in.	mm in.	mm in.	mm in.	mm in.				kg lbs.
22.225 0.8750	23.812 0.9375	-3.8 -0.15	2.3 0.09	57.0 2.24	60.0 2.36	0.8 0.03	88.0 3.46	84.0 3.31	0.8 0.03	1.5 0.06	37.6	15.4	0.0816	0.72 1.58
30.302 1.1930	23.812 0.9375	-8.1 -0.32	3.5 0.14	58.0 2.28	64.0 2.52	3.3 0.13	87.9 3.46	82.0 3.23	1.8 0.07	1.0 0.04	49.9	14.5	0.0903	0.85 1.87
30.302 1.1930	23.812 0.9375	-8.1 -0.32	0.8 0.03	58.0 2.28	58.0 2.28	3.3 0.13	87.9 3.46	82.0 3.23	1.8 0.07	1.0 0.04	49.9	14.5	0.0903	0.86 1.89
30.302 1.1930	23.812 0.9375	-8.1 -0.32	6.4 0.25	58.0 2.28	70.0 2.76	3.3 0.13	87.9 3.46	82.0 3.23	1.8 0.07	1.0 0.04	49.9	14.5	0.0903	0.83 1.83
30.302 1.1930	23.812 0.9375	-8.1 -0.32	3.5 0.14	58.0 2.28	64.0 2.52	0.8 0.03	88.0 3.46	84.0 3.31	1.8 0.07	1.0 0.04	49.9	14.5	0.0903	0.86 1.88
30.302 1.1930	23.812 0.9375	-8.1 -0.32	6.4 0.25	58.0 2.28	70.0 2.76	3.3 0.13	87.8 3.46	82.0 3.23	1.8 0.07	1.0 0.04	49.9	14.5	0.0903	0.83 1.84
28.575 1.1250	22.225 0.8750	-7.6 -0.30	3.5 0.14	58.0 2.28	64.0 2.52	2.3 0.09	90.0 3.54	85.0 3.35	1.3 0.05	2.2 0.09	52.5	18.5	0.0910	0.85 1.87
28.575 1.1250	22.225 0.8750	-7.6 -0.30	3.5 0.14	58.0 2.28	64.0 2.52	0.8 0.03	90.0 3.54	86.0 3.39	1.3 0.05	2.2 0.09	52.5	18.5	0.0910	0.86 1.88
30.302 1.1930	23.812 0.9375	-8.1 -0.32	3.5 0.14	58.0 2.28	64.0 2.52	3.3 0.13	88.9 3.50	83.1 3.27	1.8 0.07	1.0 0.04	49.9	14.5	0.0903	0.90 1.98
21.946 0.8640	15.875 0.6250	-3.0 -0.12	2.3 0.09	60.0 2.36	61.0 2.40	0.8 0.03	92.0 3.62	89.0 3.50	1.1 0.04	2.0 0.08	42.0	15.7	0.0859	0.68 1.51
22.225 0.8750	19.050 0.7500	-3.8 -0.15	3.5 0.14	57.0 2.24	63.0 2.48	1.5 0.06	90.0 3.54	86.0 3.39	0.8 0.03	1.5 0.06	37.6	15.4	0.0816	0.71 1.56
22.225 0.8750	19.050 0.7500	-3.8 -0.15	2.3 0.09	57.0 2.24	60.0 2.36	1.5 0.06	90.0 3.54	86.0 3.39	0.8 0.03	1.5 0.06	37.6	15.4	0.0816	0.71 1.57
21.946 0.8640	20.274 0.7982	-3.0 -0.12	2.3 0.09	60.0 2.36	61.0 2.40	2.3 0.09	91.0 3.58	87.0 3.43	1.1 0.04	2.0 0.08	42.0	15.7	0.0859	0.75 1.66
21.946 0.8640	17.826 0.7018	-3.0 -0.12	2.3 0.09	60.0 2.36	61.0 2.40	0.8 0.03	92.0 3.62	90.0 3.54	1.1 0.04	2.0 0.08	42.0	15.7	0.0859	0.73 1.61
30.302 1.1930	23.812 0.9375	-8.1 -0.32	3.5 0.14	58.0 2.28	64.0 2.52	3.3 0.13	89.9 3.54	84.1 3.31	1.8 0.07	1.0 0.04	49.9	14.5	0.0903	0.99 2.17
21.946 0.8640	17.826 0.7018	-3.0 -0.12	2.3 0.09	60.0 2.36	61.0 2.40	2.0 0.08	93.0 3.66	89.0 3.50	1.1 0.04	2.0 0.08	42.0	15.7	0.0859	0.76 1.68
22.225 0.8750	21.824 0.8592	-3.8 -0.15	2.3 0.09	57.0 2.24	60.0 2.36	2.0 0.08	90.0 3.54	86.0 3.39	0.8 0.03	1.5 0.06	37.6	15.4	0.0816	0.85 1.88

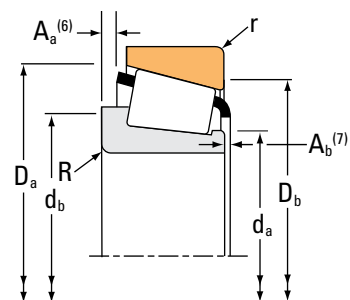
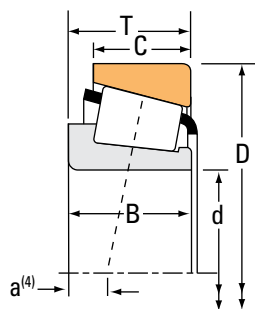
(4) Negative value indicates effective center inside cone (inner-ring) backface.
 (5) These maximum fillet radii will be cleared by the bearing corners.
 (6) Negative value indicates cage extends beyond cone (inner-ring) backface.
 (7) Negative value indicates cage that does not extend beyond cone (inner-ring) front face.

Continued on next page.

TAPERED ROLLER BEARINGS

SINGLE-ROW • TYPE TS

TYPE TS



Bearing Dimensions			Load Ratings							Part Number		
Bore d	O.D. D	Width T	Dynamic ⁽¹⁾		Factors ⁽²⁾		Dynamic ⁽³⁾		Factors ⁽²⁾	Static	Inner	Outer
			C ₁	e	Y	C ₉₀	C _{a90}	K	C ₀			
mm in.	mm in.	mm in.	N lbf			N lbf	N lbf			N lbf		
50.800 2.0000	100.000 3.9370	25.400 1.0000	108000 24200	0.35	1.69	28000 6280	16900 3810	1.65		107000 24100	385A	383X
50.800 2.0000	100.000 3.9370	34.925 1.3750	165000 37000	0.29	2.10	42700 9600	20800 4690	2.05		191000 43000	529	520X
50.800 2.0000	100.000 3.9370	34.925 1.3750	165000 37000	0.29	2.10	42700 9600	20800 4690	2.05		191000 43000	529X	520X
50.800 2.0000	100.000 3.9370	34.925 1.3750	165000 37000	0.29	2.10	42700 9600	20800 4690	2.05		191000 43000	529X	J520
50.800 2.0000	101.600 4.0000	31.750 1.2500	157000 35400	0.40	1.50	40800 9170	28000 6290	1.46		155000 35000	49585	49520
50.800 2.0000	101.600 4.0000	31.750 1.2500	157000 35400	0.40	1.50	40800 9170	28000 6290	1.46		155000 35000	49585	49522
50.800 2.0000	101.600 4.0000	34.925 1.3750	165000 37000	0.29	2.10	42700 9600	20800 4690	2.05		191000 43000	529	522
50.800 2.0000	101.600 4.0000	34.925 1.3750	165000 37000	0.29	2.10	42700 9600	20800 4690	2.05		191000 43000	529X	522
50.800 2.0000	104.775 4.1250	30.162 1.1875	161000 36100	0.34	1.79	41700 9370	23900 5380	1.74		166000 37200	455	453X
50.800 2.0000	104.775 4.1250	30.162 1.1875	161000 36100	0.34	1.79	41700 9370	23900 5380	1.74		166000 37200	455-S	453X
50.800 2.0000	104.775 4.1250	30.162 1.1875	153000 34500	0.33	1.80	39700 8930	22600 5090	1.76		189000 42600	45285	45220
50.800 2.0000	104.775 4.1250	30.162 1.1875	153000 34500	0.33	1.80	39700 8930	22600 5090	1.76		189000 42600	45284	45220
50.800 2.0000	104.775 4.1250	30.162 1.1875	153000 34500	0.33	1.80	39700 8930	22600 5090	1.76		189000 42600	45285	45221
50.800 2.0000	104.775 4.1250	30.162 1.1875	153000 34500	0.33	1.80	39700 8930	22600 5090	1.76		189000 42600	45285A	45220
50.800 2.0000	104.775 4.1250	30.162 1.1875	153000 34500	0.33	1.80	39700 8930	22600 5090	1.76		189000 42600	45284	45221
50.800 2.0000	104.775 4.1250	30.162 1.1875	153000 34500	0.33	1.80	39700 8930	22600 5090	1.76		189000 42600	45285A	45221
50.800 2.0000	104.775 4.1250	36.512 1.4375	202000 45500	0.40	1.49	52400 11800	36100 8110	1.45		202000 45400	59200	59412

⁽¹⁾Based on 1 x 10⁶ revolutions L₁₀ life, for the ISO life-calculation method.

⁽²⁾Consult your Timken engineer for instructions on use or review the Timken Engineering Manual on timken.com/catalogs.

⁽³⁾Based on 90 x 10⁶ revolutions L₁₀ life, for The Timken Company life-calculation method. C₉₀ and C_{a90} are radial and thrust values.

Bearing Dimensions											Geometry Factors			Bearing Weight
Width B	Width C	Eff. Ctr. a ⁽⁴⁾	Shaft			Housing			Cage		G ₁	G ₂	C _g	
			Max Shaft Fillet Radius R ⁽⁵⁾	Backing Shoulder Dia. d _a	Shoulder Dia. d _b	Max Housing Fillet Radius r ⁽⁵⁾	Backing Shoulder Dia. D _a	Shoulder Dia. D _b	A _a ⁽⁶⁾	A _b ⁽⁷⁾				
mm in.	mm in.	mm in.	mm in.	mm in.	mm in.	mm in.	mm in.	mm in.	mm in.	mm in.				kg lbs.
21.946 0.8640	22.225 0.8750	-3.0 -0.12	2.3 0.09	60.0 2.36	61.0 2.40	1.3 0.05	93.0 3.66	89.0 3.50	1.1 0.04	2.0 0.08	42.0	15.7	0.0859	0.85 1.88
36.068 1.4200	26.988 1.0625	-12.7 -0.50	0.8 0.03	60.0 2.36	61.0 2.40	3.3 0.13	94.0 3.70	88.0 3.46	2.7 0.10	1.8 0.07	57.9	13.4	0.0894	1.17 2.61
36.068 1.4200	26.988 1.0625	-12.7 -0.50	3.5 0.14	58.0 2.28	65.0 2.56	3.3 0.13	94.0 3.70	88.0 3.46	2.7 0.10	1.8 0.07	57.9	13.4	0.0894	1.17 2.59
36.068 1.4200	26.988 1.0625	-12.7 -0.50	3.5 0.14	58.0 2.28	65.0 2.56	3.3 0.13	94.0 3.70	88.0 3.46	2.7 0.10	1.8 0.07	57.9	13.4	0.0894	1.19 2.63
31.750 1.2500	25.400 1.0000	-7.1 -0.28	3.5 0.14	59.0 2.32	66.0 2.60	3.3 0.13	96.0 3.78	88.0 3.46	2.3 0.09	1.4 0.06	49.1	16.8	0.0946	1.12 2.46
31.750 1.2500	25.400 1.0000	-7.1 -0.28	3.5 0.14	59.0 2.32	66.0 2.60	0.8 0.03	96.0 3.78	90.0 3.54	2.3 0.09	1.4 0.06	49.1	16.8	0.0946	1.13 2.49
36.068 1.4200	26.988 1.0625	-12.7 -0.50	0.8 0.03	60.0 2.36	61.0 2.40	3.3 0.13	95.0 3.74	89.0 3.50	2.7 0.10	1.8 0.07	57.9	13.4	0.0894	1.23 2.73
36.068 1.4200	26.988 1.0625	-12.7 -0.50	3.5 0.14	58.0 2.28	65.0 2.56	3.3 0.13	95.0 3.74	89.0 3.50	2.7 0.10	1.8 0.07	57.9	13.4	0.0894	1.23 2.71
29.317 1.1542	24.605 0.9687	-7.1 -0.28	0.8 0.03	59.0 2.32	60.0 2.36	3.3 0.13	98.0 3.86	92.0 3.62	2.1 0.08	1.4 0.06	58.6	17.1	0.0946	1.18 2.58
29.317 1.1542	24.605 0.9687	-7.1 -0.28	3.5 0.14	59.0 2.32	65.0 2.56	3.3 0.13	98.0 3.86	92.0 3.62	2.1 0.08	1.4 0.06	58.6	17.1	0.0946	1.17 2.56
30.958 1.2188	23.812 0.9375	-8.1 -0.32	2.3 0.09	59.0 2.32	63.0 2.48	3.3 0.13	99.0 3.90	93.0 3.66	2.1 0.08	1.8 0.07	63.5	16.9	0.0971	1.22 2.68
30.958 1.2188	23.812 0.9375	-8.1 -0.32	6.4 0.25	59.0 2.32	71.0 2.80	3.3 0.13	99.0 3.90	93.0 3.66	2.1 0.08	1.8 0.07	63.5	16.9	0.0971	1.19 2.62
30.958 1.2188	23.812 0.9375	-8.1 -0.32	2.3 0.09	59.0 2.32	63.0 2.48	0.8 0.03	99.0 3.90	95.0 3.74	2.1 0.08	1.8 0.07	63.5	16.9	0.0971	1.22 2.69
30.958 1.2188	23.812 0.9375	-8.1 -0.32	0.8 0.03	59.0 2.32	60.0 2.36	3.3 0.13	99.0 3.90	93.0 3.66	2.1 0.08	1.8 0.07	63.5	16.9	0.0971	1.22 2.68
30.958 1.2188	23.812 0.9375	-8.1 -0.32	6.4 0.25	59.0 2.32	71.0 2.80	0.8 0.03	99.0 3.90	95.0 3.74	2.1 0.08	1.8 0.07	63.5	16.9	0.0971	1.19 2.62
30.958 1.2188	23.812 0.9375	-8.1 -0.32	0.8 0.03	59.0 2.32	60.0 2.36	0.8 0.03	99.0 3.90	95.0 3.74	2.1 0.08	1.8 0.07	63.5	16.9	0.0971	1.22 2.68
36.512 1.4375	28.575 1.1250	-9.7 -0.38	3.5 0.14	61.0 2.40	68.0 2.68	3.3 0.13	99.0 3.90	92.0 3.62	3.4 0.13	1.3 0.05	57.3	15.2	0.0999	1.41 3.09

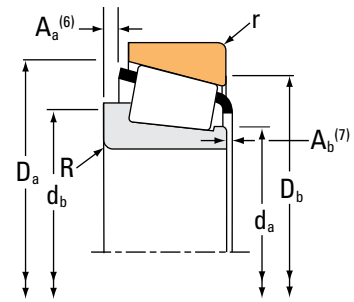
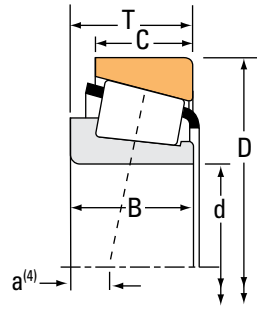
⁽⁴⁾Negative value indicates effective center inside cone (inner-ring) backface.
⁽⁵⁾These maximum fillet radii will be cleared by the bearing corners.
⁽⁶⁾Negative value indicates cage extends beyond cone (inner-ring) backface.
⁽⁷⁾Negative value indicates cage that does not extend beyond cone (inner-ring) front face.

Continued on next page.

TAPERED ROLLER BEARINGS

SINGLE-ROW • TYPE TS

TYPE TS



Bearing Dimensions			Load Ratings							Part Number			
Bore d	O.D. D	Width T	Dynamic ⁽¹⁾		Factors ⁽²⁾		Dynamic ⁽³⁾		Factors ⁽²⁾		Static C ₀	Inner	Outer
			C ₁	e	Y	C ₉₀	C _{a90}	K	N	N			
mm in.	mm in.	mm in.	N lbf			N lbf	N lbf		N lbf				
50.800 2.0000	104.775 4.1250	36.512 1.4375	202000 45500	0.40	1.49	52400 11800	36100 8110	1.45	202000 45400		59200	59413	
50.800 2.0000	104.775 4.1250	36.512 1.4375	203000 45700	0.49	1.23	52700 11900	44000 9890	1.20	223000 50200		HM807046	HM807010	
50.800 2.0000	104.775 4.1250	36.512 1.4375	203000 45700	0.49	1.23	52700 11900	44000 9890	1.20	223000 50200		HM807046	HM807011	
50.800 2.0000	104.775 4.1250	36.512 1.4375	202000 45500	0.40	1.49	52400 11800	36100 8110	1.45	202000 45400		59201	59412	
50.800 2.0000	104.775 4.1250	39.688 1.5625	180000 40500	0.34	1.79	46800 10500	26800 6030	1.74	237000 53200		4580	4535	
50.800 2.0000	105.000 4.1339	36.873 1.4517	203000 45700	0.49	1.23	52700 11900	44000 9890	1.20	223000 50200		HM807046	JHM807012	
50.800 2.0000	107.950 4.2500	27.783 1.0938	161000 36100	0.34	1.79	41700 9370	23900 5380	1.74	166000 37200		455	453A	
50.800 2.0000	107.950 4.2500	27.783 1.0938	161000 36100	0.34	1.79	41700 9370	23900 5380	1.74	166000 37200		455-S	453A	
50.800 2.0000	107.950 4.2500	27.795 1.0943	161000 36100	0.34	1.79	41700 9370	23900 5380	1.74	166000 37200		455	453	
50.800 2.0000	107.950 4.2500	36.512 1.4375	202000 45500	0.40	1.49	52400 11800	36100 8110	1.45	202000 45400		59200	59425	
50.800 2.0000	110.000 4.3307	27.795 1.0943	161000 36100	0.34	1.79	41700 9370	23900 5380	1.74	166000 37200		455	454	
50.800 2.0000	111.125 4.3750	30.162 1.1875	126000 28300	0.88	0.68	32700 7350	49500 11100	0.66	119000 26700		55200	55437	
50.800 2.0000	111.125 4.3750	30.162 1.1875	123000 27700	0.88	0.68	31900 7170	48200 10800	0.66	153000 34400		HM907643	HM907614	
50.800 2.0000	111.125 4.3750	30.162 1.1875	151000 34000	0.88	0.68	39200 8810	59300 13300	0.66	161000 36200		55200C	55437	
50.800 2.0000	111.125 4.3750	38.108 1.5003	161000 36100	0.34	1.79	41700 9370	23900 5380	1.74	166000 37200		455	4536	
50.800 2.0000	111.125 4.3750	38.108 1.5003	161000 36100	0.34	1.79	41700 9370	23900 5380	1.74	166000 37200		455-S	4536	
50.800 2.0000	112.712 4.4375	30.162 1.1875	126000 28300	0.88	0.68	32700 7350	49500 11100	0.66	119000 26700		55200	55443	

⁽¹⁾Based on 1 x 10⁶ revolutions L₁₀ life, for the ISO life-calculation method.

⁽²⁾Consult your Timken engineer for instructions on use or review the Timken Engineering Manual on timken.com/catalogs.

⁽³⁾Based on 90 x 10⁶ revolutions L₁₀ life, for The Timken Company life-calculation method. C₉₀ and C_{a90} are radial and thrust values.

Bearing Dimensions											Geometry Factors			Bearing Weight
Width B	Width C	Eff. Ctr. a ⁽⁴⁾	Shaft			Housing			Cage		G ₁	G ₂	C _g	
			Max Shaft Fillet Radius R ⁽⁵⁾	Backing Shoulder Dia. d _a	Backing Shoulder Dia. d _b	Max Housing Fillet Radius r ⁽⁵⁾	Backing Shoulder Dia. D _a	Backing Shoulder Dia. D _b	A _a ⁽⁶⁾	A _b ⁽⁷⁾				
mm in.	mm in.	mm in.	mm in.	mm in.	mm in.	mm in.	mm in.	mm in.	mm in.	mm in.				kg lbs.
36.512 1.4375	28.575 1.1250	-9.7 -0.38	3.5 0.14	61.0 2.40	68.0 2.68	0.8 0.03	102.0 4.02	87.0 3.43	3.4 0.13	1.3 0.05	57.3	15.2	0.0999	1.42 3.12
36.512 1.4375	28.575 1.1250	-7.4 -0.29	3.5 0.14	63.1 2.48	70.0 2.76	3.3 0.13	100.0 3.94	89.0 3.50	3.4 0.13	2.0 0.08	63.9	17.1	0.0760	1.47 3.24
36.512 1.4375	28.575 1.1250	-7.4 -0.29	3.5 0.14	63.1 2.48	70.0 2.76	0.8 0.03	100.0 3.94	91.0 3.58	3.4 0.13	2.0 0.08	63.9	17.1	0.0760	1.47 3.24
36.512 1.4375	28.575 1.1250	-9.7 -0.38	0.8 0.03	61.0 2.40	62.0 2.44	3.3 0.13	99.0 3.90	92.0 3.62	3.4 0.13	1.3 0.05	57.3	15.2	0.0999	1.42 3.11
40.157 1.5810	33.338 1.3125	-12.4 -0.49	3.5 0.14	61.0 2.40	67.0 2.64	3.3 0.13	99.0 3.90	90.0 3.54	1.6 0.06	1.3 0.05	73.6	20.2	0.1027	1.62 3.58
36.512 1.4375	29.000 1.1417	-7.4 -0.29	3.5 0.14	63.1 2.48	70.0 2.76	2.5 0.10	100.0 3.94	90.0 3.54	3.4 0.13	2.0 0.08	63.9	17.1	0.0760	1.49 3.27
29.317 1.1542	22.225 0.8750	-7.1 -0.28	0.8 0.03	59.0 2.32	60.0 2.36	0.8 0.03	100.0 3.94	97.0 3.82	2.1 0.08	1.4 0.06	58.6	17.1	0.0946	1.23 2.70
29.317 1.1542	22.225 0.8750	-7.1 -0.28	3.5 0.14	59.0 2.32	65.0 2.56	0.8 0.03	100.0 3.94	97.0 3.82	2.1 0.08	1.4 0.06	58.6	17.1	0.0946	1.22 2.69
29.317 1.1542	27.000 1.0630	-7.1 -0.28	0.8 0.03	59.0 2.32	60.0 2.36	0.8 0.03	100.0 3.94	97.0 3.82	2.1 0.08	1.4 0.06	58.6	17.1	0.0946	1.29 2.83
36.512 1.4375	28.575 1.1250	-9.7 -0.38	3.5 0.14	61.0 2.40	68.0 2.68	3.3 0.13	101.0 3.98	93.0 3.66	3.4 0.13	1.3 0.05	57.3	15.2	0.0999	1.52 3.35
29.317 1.1542	27.000 1.0630	-7.1 -0.28	0.8 0.03	59.0 2.32	60.0 2.36	2.0 0.08	100.0 3.94	96.0 3.78	2.1 0.08	1.4 0.06	58.6	17.1	0.0946	1.36 2.98
26.909 1.0594	20.638 0.8125	7.1 0.28	3.5 0.14	63.9 2.51	71.0 2.80	3.3 0.13	105.0 4.13	92.0 3.62	4.8 0.18	3.2 0.13	36.8	13.2	0.1085	1.26 2.79
28.575 1.1250	20.638 0.8125	7.6 0.30	3.5 0.14	65.3 2.56	74.0 2.91	3.3 0.13	105.0 4.13	91.0 3.58	4.6 0.18	2.1 0.08	46.9	17.5	0.1182	1.35 2.96
26.909 1.0594	20.638 0.8125	7.6 0.30	3.5 0.14	64.4 2.54	71.0 2.80	3.3 0.13	105.0 4.13	92.0 3.62	5.0 0.19	3.7 0.15	48.7	18.1	0.1198	1.36 2.98
29.317 1.1542	32.545 1.2813	-7.1 -0.28	0.8 0.03	59.0 2.32	60.0 2.36	3.3 0.13	100.0 3.94	93.0 3.66	2.1 0.08	1.4 0.06	58.6	17.1	0.0946	1.64 3.59
29.317 1.1542	32.545 1.2813	-7.1 -0.28	3.5 0.14	59.0 2.32	65.0 2.56	3.3 0.13	100.0 3.94	93.0 3.66	2.1 0.08	1.4 0.06	58.6	17.1	0.0946	1.63 3.58
26.909 1.0594	20.638 0.8125	7.1 0.28	3.5 0.14	63.9 2.51	71.0 2.80	3.3 0.13	106.0 4.17	92.0 3.62	4.8 0.18	3.2 0.13	36.8	13.2	0.1085	1.29 2.87

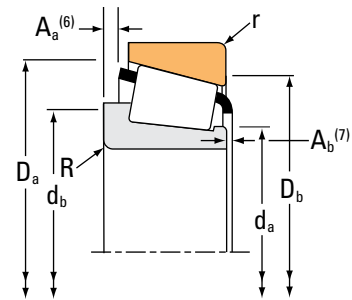
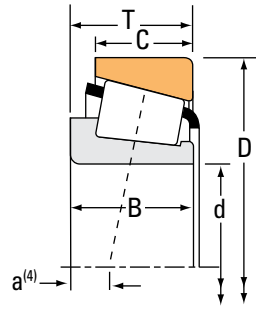
(4) Negative value indicates effective center inside cone (inner-ring) backface.
 (5) These maximum fillet radii will be cleared by the bearing corners.
 (6) Negative value indicates cage extends beyond cone (inner-ring) backface.
 (7) Negative value indicates cage that does not extend beyond cone (inner-ring) front face.

Continued on next page.

TAPERED ROLLER BEARINGS

SINGLE-ROW • TYPE TS

TYPE TS



Bearing Dimensions			Load Ratings							Part Number			
Bore d	O.D. D	Width T	Dynamic ⁽¹⁾		Factors ⁽²⁾		Dynamic ⁽³⁾		Factors ⁽²⁾		Static C ₀	Inner	Outer
			C ₁	e	Y	C ₉₀	C _{a90}	K	N	N			
mm in.	mm in.	mm in.	N lbf			N lbf	N lbf		N lbf				
50.800 2.0000	112.712 4.4375	30.162 1.1875	167000 37500	0.34	1.77	43300 9730	25100 5650	1.72	224000 50300			39575	39520
50.800 2.0000	112.712 4.4375	30.162 1.1875	167000 37500	0.34	1.77	43300 9730	25100 5650	1.72	224000 50300			39573	39521
50.800 2.0000	112.712 4.4375	30.162 1.1875	167000 37500	0.34	1.77	43300 9730	25100 5650	1.72	224000 50300			39573	39520
50.800 2.0000	112.712 4.4375	30.162 1.1875	167000 37500	0.34	1.77	43300 9730	25100 5650	1.72	224000 50300			39575	39521
50.800 2.0000	114.300 4.5000	44.450 1.7500	224000 50300	0.43	1.39	58000 13000	42700 9600	1.36	256000 57500			65395	65320
50.800 2.0000	117.475 4.6250	33.338 1.3125	177000 39700	0.63	0.96	45800 10300	49100 11000	0.93	166000 37300			66200	66462
50.800 2.0000	120.650 4.7500	41.275 1.6250	207000 46600	0.31	1.91	53800 12100	28900 6510	1.86	244000 54800			619	612
50.800 2.0000	122.238 4.8125	43.658 1.7188	237000 53200	0.36	1.67	61300 13800	37600 8460	1.63	327000 73500			5565	5535
50.800 2.0000	123.825 4.8750	36.512 1.4375	214000 48200	0.74	0.81	55500 12500	70100 15800	0.79	208000 46800			72200C	72487
50.800 2.0000	123.825 4.8750	36.512 1.4375	214000 48200	0.74	0.81	55500 12500	70100 15800	0.79	208000 46800			72201C	72487
50.800 2.0000	123.825 4.8750	38.100 1.5000	191000 42900	0.35	1.73	49400 11100	29300 6590	1.69	248000 55700			555	552A
50.800 2.0000	123.825 4.8750	38.100 1.5000	191000 42900	0.35	1.73	49400 11100	29300 6590	1.69	248000 55700			555	552
50.800 2.0000	127.000 5.0000	36.512 1.4375	229000 51500	0.50	1.20	59400 13400	51100 11500	1.16	256000 57600			HM813836	HM813810
50.800 2.0000	127.000 5.0000	44.450 1.7500	243000 54700	0.49	1.23	63100 14200	52700 11800	1.20	297000 66700			65200	65500
50.800 2.0000	127.000 5.0000	50.800 2.0000	306000 68800	0.30	2.01	79300 17800	40500 9110	1.96	370000 83300			6279	6220
51.592 2.0312	88.900 3.5000	20.638 0.8125	102000 22900	0.32	1.88	26400 5930	14400 3250	1.83	95800 21500			368-S	362A
51.592 2.0312	90.000 3.5433	20.000 0.7874	102000 22900	0.32	1.88	26400 5930	14400 3250	1.83	95800 21500			368-S	362

⁽¹⁾Based on 1 x 10⁶ revolutions L₁₀ life, for the ISO life-calculation method.

⁽²⁾Consult your Timken engineer for instructions on use or review the Timken Engineering Manual on timken.com/catalogs.

⁽³⁾Based on 90 x 10⁶ revolutions L₁₀ life, for The Timken Company life-calculation method. C₉₀ and C_{a90} are radial and thrust values.

Bearing Dimensions											Geometry Factors			Bearing Weight
Width B	Width C	Eff. Ctr. a ⁽⁴⁾	Shaft			Housing			Cage		G ₁	G ₂	C _g	
			Max Shaft Fillet Radius R ⁽⁵⁾	Backing Shoulder Dia. d _a	Backing Shoulder Dia. d _b	Max Housing Fillet Radius r ⁽⁵⁾	Backing Shoulder Dia. D _a	Backing Shoulder Dia. D _b	A _a ⁽⁶⁾	A _b ⁽⁷⁾				
mm in.	mm in.	mm in.	mm in.	mm in.	mm in.	mm in.	mm in.	mm in.	mm in.	mm in.				kg lbs.
30.162 1.1875	23.812 0.9375	-6.6 -0.26	3.5 0.14	61.0 2.40	68.0 2.68	3.3 0.13	107.0 4.21	101.0 3.98	1.6 0.06	2.7 0.11	84.3	23.7	0.1074	1.50 3.31
30.162 1.1875	23.812 0.9375	-6.6 -0.26	0.8 0.03	61.0 2.40	62.0 2.44	0.8 0.03	107.0 4.21	103.0 4.06	1.6 0.06	2.7 0.11	84.3	23.7	0.1074	1.51 3.35
30.162 1.1875	23.812 0.9375	-6.6 -0.26	0.8 0.03	61.0 2.40	62.0 2.44	3.3 0.13	107.0 4.21	101.0 3.98	1.6 0.06	2.7 0.11	84.3	23.7	0.1074	1.51 3.33
30.162 1.1875	23.812 0.9375	-6.6 -0.26	3.5 0.14	61.0 2.40	68.0 2.68	0.8 0.03	107.0 4.21	103.0 4.06	1.6 0.06	2.7 0.11	84.3	23.7	0.1074	1.50 3.33
44.450 1.7500	34.925 1.3750	-12.4 -0.49	3.5 0.14	60.0 2.36	72.0 2.83	3.3 0.13	107.0 4.21	97.0 3.82	3.6 0.14	1.1 0.05	63.1	13.0	0.1053	2.15 4.73
31.750 1.2500	23.812 0.9375	-0.3 -0.01	3.5 0.14	65.0 2.56	71.0 2.80	3.3 0.13	111.0 4.37	100.0 3.94	5.0 0.19	2.0 0.08	50.2	16.4	0.0751	1.63 3.61
41.275 1.6250	31.750 1.2500	-14.0 -0.55	3.5 0.14	61.0 2.40	67.0 2.64	3.3 0.13	110.0 4.33	105.0 4.13	3.8 0.15	1.9 0.08	75.9	16.2	0.0694	2.27 5.00
43.764 1.7230	36.512 1.4375	-12.2 -0.48	1.3 0.05	65.0 2.56	67.0 2.64	3.3 0.13	116.0 4.57	106.0 4.17	2.5 0.09	1.3 0.05	110.4	24.2	0.0825	2.68 5.92
32.791 1.2910	25.400 1.0000	2.0 0.08	3.5 0.14	67.0 2.64	77.0 3.03	3.3 0.13	116.0 4.57	102.0 4.02	4.7 0.18	4.4 0.18	57.4	15.9	0.0825	2.12 4.68
32.791 1.2910	25.400 1.0000	2.0 0.08	0.8 0.03	67.0 2.64	77.0 3.03	3.3 0.13	116.0 4.57	102.0 4.02	4.7 0.18	4.4 0.18	57.4	15.9	0.0825	2.12 4.68
36.678 1.4440	30.162 1.1875	-9.4 -0.37	2.3 0.09	62.0 2.44	66.0 2.60	3.3 0.13	116.0 4.57	109.0 4.29	2.3 0.09	1.3 0.05	91.0	21.1	0.1108	2.31 5.09
36.678 1.4440	33.338 1.3125	-9.4 -0.37	2.3 0.09	62.0 2.44	66.0 2.60	3.3 0.13	116.0 4.57	109.0 4.29	2.3 0.09	1.3 0.05	91.0	21.1	0.1108	2.36 5.20
36.512 1.4375	26.988 1.0625	-3.8 -0.15	3.5 0.14	69.0 2.72	75.0 2.95	3.3 0.13	121.0 4.76	111.0 4.37	4.0 0.15	1.3 0.06	91.7	22.9	0.1252	2.41 5.33
44.450 1.7500	34.925 1.3750	-9.4 -0.37	3.5 0.14	69.0 2.72	75.0 2.95	3.3 0.13	119.0 4.69	107.0 4.21	4.1 0.16	1.1 0.05	83.2	17.2	0.0827	2.90 6.38
52.388 2.0625	41.275 1.6250	-19.6 -0.77	3.5 0.14	65.0 2.56	71.0 2.80	3.3 0.13	117.0 4.61	108.0 4.25	2.3 0.09	2.6 0.11	103.1	18.7	0.0757	3.37 7.42
22.225 0.8750	16.513 0.6501	-4.3 -0.17	2.0 0.08	56.0 2.20	59.0 2.32	1.3 0.05	84.0 3.31	81.0 3.19	0.4 0.01	1.1 0.04	33.8	14.0	0.0773	0.50 1.10
22.225 0.8750	15.875 0.6250	-4.3 -0.17	2.0 0.08	56.0 2.20	59.0 2.32	2.0 0.08	84.0 3.31	81.0 3.19	0.4 0.01	1.1 0.04	33.8	14.0	0.0773	0.50 1.11

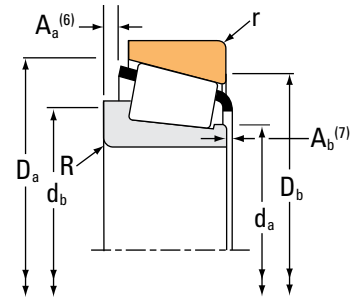
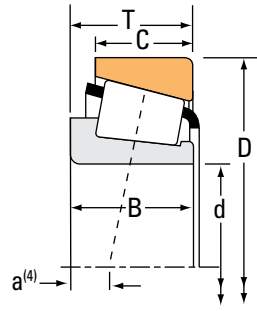
⁽⁴⁾Negative value indicates effective center inside cone (inner-ring) backface.
⁽⁵⁾These maximum fillet radii will be cleared by the bearing corners.
⁽⁶⁾Negative value indicates cage extends beyond cone (inner-ring) backface.
⁽⁷⁾Negative value indicates cage that does not extend beyond cone (inner-ring) front face.

Continued on next page.

TAPERED ROLLER BEARINGS

SINGLE-ROW • TYPE TS

TYPE TS



Bearing Dimensions			Load Ratings							Part Number			
Bore d	O.D. D	Width T	Dynamic ⁽¹⁾		Factors ⁽²⁾		Dynamic ⁽³⁾		Factors ⁽²⁾		Static C ₀	Inner	Outer
			C ₁	e	Y	C ₉₀	C _{a90}	K	N	N			
mm in.	mm in.	mm in.	N lbf			N lbf	N lbf		N lbf		N lbf		
52.000 2.0472	85.000 3.3465	19.050 0.7500	51600 11600	0.57	1.06	13400 3010	13000 2920	1.03	63900 14400			18204X	18335X
52.387 2.0625	89.980 3.5425	24.750 0.9744	98900 22200	0.38	1.59	25700 5770	16600 3720	1.55	130000 29200			28584	28520
52.387 2.0625	92.075 3.6250	24.608 0.9688	98900 22200	0.38	1.59	25700 5770	16600 3720	1.55	130000 29200			28584	28521
52.387 2.0625	93.264 3.6718	20.638 0.8125	87900 19800	0.34	1.77	22800 5120	13200 2970	1.73	101000 22700			377A	374
52.387 2.0625	93.264 3.6718	20.638 0.8125	104000 23400	0.34	1.77	27000 6070	15700 3520	1.73	101000 22700			377	374
52.387 2.0625	93.264 3.6718	26.988 1.0625	104000 23400	0.34	1.77	27000 6070	15700 3520	1.73	101000 22700			377	3720
52.387 2.0625	93.264 3.6718	26.988 1.0625	87900 19800	0.34	1.77	22800 5120	13200 2970	1.73	101000 22700			377A	3720
52.387 2.0625	93.264 3.6718	26.988 1.0625	104000 23400	0.34	1.77	27000 6070	15700 3520	1.73	101000 22700			377	3730
52.387 2.0625	93.264 3.6718	30.162 1.1875	122000 27500	0.34	1.77	31700 7120	18300 4120	1.73	153000 34300			3767	3720
52.387 2.0625	93.264 3.6718	30.162 1.1875	122000 27500	0.34	1.77	31700 7120	18300 4120	1.73	153000 34300			3767	3730
52.387 2.0625	95.250 3.7500	27.783 1.0938	130000 29200	0.33	1.82	33600 7560	19000 4270	1.77	161000 36200			33890	33821
52.387 2.0625	95.250 3.7500	27.783 1.0938	130000 29200	0.33	1.82	33600 7560	19000 4270	1.77	161000 36200			33891	33821
52.387 2.0625	96.838 3.8125	22.225 0.8750	104000 23400	0.34	1.77	27000 6070	15700 3520	1.73	101000 22700			377	372A
52.387 2.0625	98.425 3.8750	30.162 1.1875	122000 27500	0.34	1.77	31700 7120	18300 4120	1.73	153000 34300			3767	3732
52.387 2.0625	100.000 3.9370	24.999 0.9842	104000 23400	0.34	1.77	27000 6070	15700 3520	1.73	101000 22700			377	372
52.387 2.0625	104.775 4.1250	30.162 1.1875	161000 36100	0.34	1.79	41700 9370	23900 5380	1.74	166000 37200			468	453X
52.387 2.0625	107.950 4.2500	27.783 1.0938	161000 36100	0.34	1.79	41700 9370	23900 5380	1.74	166000 37200			468	453A

⁽¹⁾Based on 1 x 10⁶ revolutions L₁₀ life, for the ISO life-calculation method.

⁽²⁾Consult your Timken engineer for instructions on use or review the Timken Engineering Manual on timken.com/catalogs.

⁽³⁾Based on 90 x 10⁶ revolutions L₁₀ life, for The Timken Company life-calculation method. C₉₀ and C_{a90} are radial and thrust values.

Bearing Dimensions											Geometry Factors			Bearing Weight
Width B	Width C	Eff. Ctr. a ⁽⁴⁾	Shaft			Housing			Cage		G ₁	G ₂	C _g	
			Max Shaft Fillet Radius R ⁽⁵⁾	Backing Shoulder Dia. d _a	Backing Shoulder Dia. d _b	Max Housing Fillet Radius r ⁽⁵⁾	Backing Shoulder Dia. D _a	Backing Shoulder Dia. D _b	A _a ⁽⁶⁾	A _b ⁽⁷⁾				
mm in.	mm in.	mm in.	mm in.	mm in.	mm in.	mm in.	mm in.	mm in.	mm in.	mm in.				kg lbs.
18.263 0.7190	12.500 0.4921	2.0 0.08	2.0 0.08	57.0 2.24	60.0 2.36	1.5 0.06	81.0 3.19	76.0 2.99	2.5 0.10	1.7 0.07	26.1	22.1	0.0852	0.36 0.81
25.400 1.0000	19.987 0.7869	-4.8 -0.19	3.5 0.14	58.0 2.28	65.0 2.56	2.3 0.09	86.0 3.39	81.0 3.19	1.4 0.05	1.1 0.05	46.4	18.9	0.0912	0.62 1.36
25.400 1.0000	19.845 0.7813	-4.8 -0.19	3.5 0.14	58.0 2.28	65.0 2.56	0.8 0.03	87.0 3.43	83.0 3.27	1.4 0.05	1.1 0.05	46.4	18.9	0.0912	0.66 1.47
22.225 0.8750	15.083 0.5938	-3.8 -0.15	4.8 0.19	58.0 2.28	67.0 2.64	1.3 0.05	88.0 3.46	85.0 3.35	0.8 0.03	1.5 0.06	37.6	15.4	0.0816	0.56 1.23
22.225 0.8750	15.083 0.5938	-3.8 -0.15	2.3 0.09	58.0 2.28	62.0 2.44	1.3 0.05	88.0 3.46	85.0 3.35	0.8 0.03	1.5 0.06	37.6	15.4	0.0816	0.57 1.26
22.225 0.8750	23.812 0.9375	-3.8 -0.15	2.3 0.09	58.0 2.28	62.0 2.44	3.3 0.13	87.9 3.46	82.0 3.23	0.8 0.03	1.5 0.06	37.6	15.4	0.0816	0.69 1.52
22.225 0.8750	23.812 0.9375	-3.8 -0.15	4.8 0.19	58.0 2.28	67.0 2.64	3.3 0.13	87.9 3.46	82.0 3.23	0.8 0.03	1.5 0.06	37.6	15.4	0.0816	0.68 1.49
22.225 0.8750	23.812 0.9375	-3.8 -0.15	2.3 0.09	58.0 2.28	62.0 2.44	0.8 0.03	88.0 3.46	84.0 3.31	0.8 0.03	1.5 0.06	37.6	15.4	0.0816	0.70 1.53
30.302 1.1930	23.812 0.9375	-8.1 -0.32	2.3 0.09	59.0 2.32	63.0 2.48	3.3 0.13	87.9 3.46	82.0 3.23	1.8 0.07	1.0 0.04	49.9	14.5	0.0903	0.83 1.81
30.302 1.1930	23.812 0.9375	-8.1 -0.32	2.3 0.09	59.0 2.32	63.0 2.48	0.8 0.03	88.0 3.46	84.0 3.31	1.8 0.07	1.0 0.04	49.9	14.5	0.0903	0.84 1.83
28.575 1.1250	22.225 0.8750	-7.6 -0.30	1.5 0.06	59.0 2.32	61.0 2.40	2.3 0.09	90.0 3.54	85.0 3.35	1.3 0.05	2.2 0.09	52.5	18.5	0.0910	0.83 1.82
28.575 1.1250	22.225 0.8750	-7.6 -0.30	3.5 0.14	59.0 2.32	66.0 2.60	2.3 0.09	90.0 3.54	85.0 3.35	1.3 0.05	2.2 0.09	52.5	18.5	0.0910	0.82 1.80
22.225 0.8750	19.050 0.7500	-3.8 -0.15	2.3 0.09	58.0 2.28	62.0 2.44	1.5 0.06	90.0 3.54	86.0 3.39	0.8 0.03	1.5 0.06	37.6	15.4	0.0816	0.69 1.52
30.302 1.1930	23.812 0.9375	-8.1 -0.32	2.3 0.09	59.0 2.32	63.0 2.48	3.3 0.13	89.9 3.54	84.1 3.31	1.8 0.07	1.0 0.04	49.9	14.5	0.0903	0.97 2.12
22.225 0.8750	21.824 0.8592	-3.8 -0.15	2.3 0.09	58.0 2.28	62.0 2.44	2.0 0.08	90.0 3.54	86.0 3.39	0.8 0.03	1.5 0.06	37.6	15.4	0.0816	0.83 1.83
29.317 1.1542	24.605 0.9687	-7.1 -0.28	1.5 0.06	60.0 2.36	62.0 2.44	3.3 0.13	98.0 3.86	92.0 3.62	2.1 0.08	1.4 0.06	58.6	17.1	0.0946	1.13 2.48
29.317 1.1542	22.225 0.8750	-7.1 -0.28	1.5 0.06	60.0 2.36	62.0 2.44	0.8 0.03	100.0 3.94	97.0 3.82	2.1 0.08	1.4 0.06	58.6	17.1	0.0946	1.18 2.60

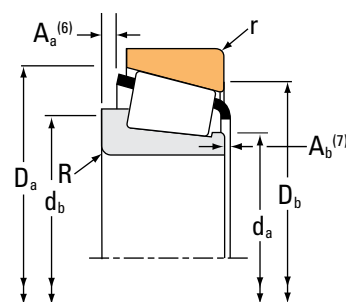
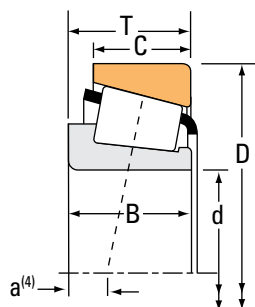
⁽⁴⁾Negative value indicates effective center inside cone (inner-ring) backface.
⁽⁵⁾These maximum fillet radii will be cleared by the bearing corners.
⁽⁶⁾Negative value indicates cage extends beyond cone (inner-ring) backface.
⁽⁷⁾Negative value indicates cage that does not extend beyond cone (inner-ring) front face.

Continued on next page.

TAPERED ROLLER BEARINGS

SINGLE-ROW • TYPE TS

TYPE TS



Bearing Dimensions			Load Ratings							Part Number			
Bore d	O.D. D	Width T	Dynamic ⁽¹⁾		Factors ⁽²⁾		Dynamic ⁽³⁾		Factors ⁽²⁾		Static C ₀	Inner	Outer
			C ₁	e	Y	C ₉₀	C _{a90}	K	N	N			
mm in.	mm in.	mm in.	N lbf			N lbf	N lbf		N lbf				
52.387 2.0625	107.950 4.2500	27.783 1.0938	161000 36100	0.34	1.79	41700 9370	23900 5380	1.74	166000 37200		468	453AS	
52.387 2.0625	107.950 4.2500	36.512 1.4375	172000 38700	0.30	2.02	44600 10000	22700 5090	1.97	206000 46200		540	532X	
52.387 2.0625	110.000 4.3307	34.130 1.3437	172000 38700	0.30	2.02	44600 10000	22700 5090	1.97	206000 46200		540	534	
52.387 2.0625	111.125 4.3750	30.162 1.1875	126000 28300	0.88	0.68	32700 7350	49500 11100	0.66	119000 26700		55206	55437	
52.387 2.0625	111.125 4.3750	30.162 1.1875	151000 34000	0.88	0.68	39200 8810	59300 13300	0.66	161000 36200		55206C	55437	
52.387 2.0625	111.125 4.3750	38.100 1.5000	172000 38700	0.30	2.02	44600 10000	22700 5090	1.97	206000 46200		540	532A	
52.387 2.0625	112.712 4.4375	30.162 1.1875	126000 28300	0.88	0.68	32700 7350	49500 11100	0.66	119000 26700		55206	55443	
53.975 2.1250	87.312 3.4375	18.258 0.7188	62700 14100	0.39	1.54	16300 3650	10800 2430	1.50	95600 21500		L507945	L507910	
53.975 2.1250	88.900 3.5000	19.050 0.7500	65500 14700	0.55	1.10	17000 3820	15900 3570	1.07	81800 18400		LM806649	LM806610	
53.975 2.1250	95.250 3.7500	27.783 1.0938	130000 29200	0.33	1.82	33600 7560	19000 4270	1.77	161000 36200		33895	33821	
53.975 2.1250	95.250 3.7500	27.783 1.0938	130000 29200	0.33	1.82	33600 7560	19000 4270	1.77	161000 36200		33895	33822	
53.975 2.1250	96.838 3.8125	21.000 0.8268	108000 24200	0.35	1.69	28000 6280	16900 3810	1.65	107000 24100		389A	382A	
53.975 2.1250	98.425 3.8750	21.000 0.8268	108000 24200	0.35	1.69	28000 6280	16900 3810	1.65	107000 24100		389A	382	
53.975 2.1250	100.000 3.9370	21.000 0.8268	108000 24200	0.35	1.69	28000 6280	16900 3810	1.65	107000 24100		389A	383A	
53.975 2.1250	104.775 4.1250	30.162 1.1875	153000 34500	0.33	1.80	39700 8930	22600 5090	1.76	189000 42600		45287	45221	
53.975 2.1250	104.775 4.1250	30.162 1.1875	161000 36100	0.34	1.79	41700 9370	23900 5380	1.74	166000 37200		456	453X	
53.975 2.1250	104.775 4.1250	30.162 1.1875	153000 34500	0.33	1.80	39700 8930	22600 5090	1.76	189000 42600		45287	45220	

⁽¹⁾Based on 1×10^6 revolutions L_{10} life, for the ISO life-calculation method.

⁽²⁾Consult your Timken engineer for instructions on use or review the Timken Engineering Manual on timken.com/catalogs.

⁽³⁾Based on 90×10^6 revolutions L_{10} life, for The Timken Company life-calculation method. C_{90} and C_{a90} are radial and thrust values.

Bearing Dimensions											Geometry Factors			Bearing Weight
Width B	Width C	Eff. Ctr. a ⁽⁴⁾	Shaft			Housing			Cage		G ₁	G ₂	C _g	
			Max Shaft Fillet Radius R ⁽⁵⁾	Backing Shoulder Dia. d _a	Backing Shoulder Dia. d _b	Max Housing Fillet Radius r ⁽⁵⁾	Backing Shoulder Dia. D _a	Backing Shoulder Dia. D _b	A _a ⁽⁶⁾	A _b ⁽⁷⁾				
mm in.	mm in.	mm in.	mm in.	mm in.	mm in.	mm in.	mm in.	mm in.	mm in.	mm in.				kg lbs.
29.317 1.1542	22.225 0.8750	-7.1 -0.28	1.5 0.06	60.0 2.36	62.0 2.44	2.3 0.09	100.0 3.94	95.0 3.74	2.1 0.08	1.4 0.06	58.6	17.1	0.0946	1.18 2.60
36.957 1.4550	28.575 1.1250	-12.2 -0.48	3.5 0.14	60.0 2.36	67.0 2.64	3.3 0.13	100.0 3.94	94.0 3.70	2.7 0.10	1.0 0.04	64.3	16.1	0.0938	1.48 3.27
36.957 1.4550	26.988 1.0625	-12.2 -0.48	3.5 0.14	60.0 2.36	67.0 2.64	3.3 0.13	100.0 3.94	94.0 3.70	2.7 0.10	1.0 0.04	64.3	16.1	0.0938	1.51 3.33
26.909 1.0594	20.638 0.8125	7.1 0.28	3.5 0.14	63.9 2.51	72.0 2.83	3.3 0.13	105.0 4.13	92.0 3.62	4.8 0.18	3.2 0.13	36.8	13.2	0.1085	1.24 2.73
26.909 1.0594	20.638 0.8125	7.6 0.30	3.5 0.14	64.4 2.54	72.0 2.83	3.3 0.13	105.0 4.13	92.0 3.62	5.0 0.19	3.7 0.15	48.7	18.1	0.1198	1.33 2.92
36.957 1.4550	30.162 1.1875	-12.2 -0.48	3.5 0.14	60.0 2.36	67.0 2.64	3.3 0.13	100.0 3.94	95.0 3.74	2.7 0.10	1.0 0.04	64.3	16.1	0.0938	1.66 3.65
26.909 1.0594	20.638 0.8125	7.1 0.28	3.5 0.14	63.9 2.51	72.0 2.83	3.3 0.13	106.0 4.17	92.0 3.62	4.8 0.18	3.2 0.13	36.8	13.2	0.1085	1.27 2.81
18.258 0.7188	14.288 0.5625	-0.8 -0.03	1.5 0.06	60.0 2.36	62.0 2.44	1.5 0.06	83.0 3.27	79.0 3.11	0.3 0.01	2.0 0.08	46.1	38.5	0.0914	0.43 0.93
19.050 0.7500	13.492 0.5312	2.3 0.09	2.3 0.09	61.0 2.40	65.0 2.56	2.0 0.08	85.0 3.35	80.0 3.15	1.5 0.05	1.6 0.07	31.8	22.1	0.0900	0.42 0.94
28.575 1.1250	22.225 0.8750	-7.6 -0.30	1.5 0.06	60.0 2.36	63.0 2.48	2.3 0.09	90.0 3.54	85.0 3.35	1.3 0.05	2.2 0.09	52.5	18.5	0.0910	0.80 1.75
28.575 1.1250	22.225 0.8750	-7.6 -0.30	1.5 0.06	60.0 2.36	63.0 2.48	0.8 0.03	90.0 3.54	86.0 3.39	1.3 0.05	2.2 0.09	52.5	18.5	0.0910	0.81 1.77
21.946 0.8640	15.875 0.6250	-3.0 -0.12	0.8 0.03	60.0 2.36	61.0 2.40	0.8 0.03	92.0 3.62	89.0 3.50	1.1 0.04	2.0 0.08	42.0	15.7	0.0859	0.64 1.41
21.946 0.8640	17.826 0.7018	-3.0 -0.12	0.8 0.03	60.0 2.36	61.0 2.40	0.8 0.03	92.0 3.62	90.0 3.54	1.1 0.04	2.0 0.08	42.0	15.7	0.0859	0.69 1.51
21.946 0.8640	17.826 0.7018	-3.0 -0.12	0.8 0.03	60.0 2.36	61.0 2.40	2.0 0.08	93.0 3.66	89.0 3.50	1.1 0.04	2.0 0.08	42.0	15.7	0.0859	0.72 1.59
30.958 1.2188	23.812 0.9375	-8.1 -0.32	0.8 0.03	62.0 2.44	62.0 2.44	0.8 0.03	99.0 3.90	95.0 3.74	2.1 0.08	1.8 0.07	63.5	16.9	0.0971	1.16 2.54
29.317 1.1542	24.605 0.9687	-7.1 -0.28	3.5 0.14	61.0 2.40	68.0 2.68	3.3 0.13	98.0 3.86	92.0 3.62	2.1 0.08	1.4 0.06	58.6	17.1	0.0946	1.11 2.43
30.958 1.2188	23.812 0.9375	-8.1 -0.32	0.8 0.03	62.0 2.44	62.0 2.44	3.3 0.13	99.0 3.90	93.0 3.66	2.1 0.08	1.8 0.07	63.5	16.9	0.0971	1.16 2.54

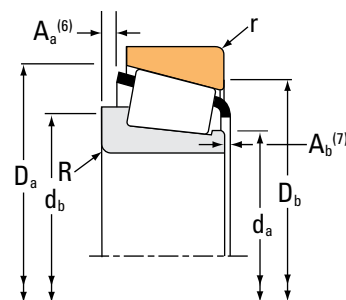
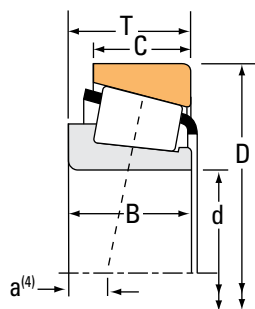
⁽⁴⁾Negative value indicates effective center inside cone (inner-ring) backface.
⁽⁵⁾These maximum fillet radii will be cleared by the bearing corners.
⁽⁶⁾Negative value indicates cage extends beyond cone (inner-ring) backface.
⁽⁷⁾Negative value indicates cage that does not extend beyond cone (inner-ring) front face.

Continued on next page.

TAPERED ROLLER BEARINGS

SINGLE-ROW • TYPE TS

TYPE TS



Bearing Dimensions			Load Ratings							Part Number		
Bore d	O.D. D	Width T	Dynamic ⁽¹⁾		Factors ⁽²⁾		Dynamic ⁽³⁾		Factors ⁽²⁾	Static	Inner	Outer
			C ₁	e	Y	C ₉₀	C _{a90}	K	C ₀			
mm in.	mm in.	mm in.	N lbf			N lbf	N lbf			N lbf		
53.975 2.1250	104.775 4.1250	36.512 1.4375	203000 45700	0.49	1.23	52700 11900	44000 9890	1.20		223000 50200	HM807049	HM807010
53.975 2.1250	104.775 4.1250	36.512 1.4375	203000 45700	0.49	1.23	52700 11900	44000 9890	1.20		223000 50200	HM807049	HM807011
53.975 2.1250	104.775 4.1250	36.512 1.4375	203000 45700	0.49	1.23	52700 11900	44000 9890	1.20		223000 50200	HM807049A	HM807011
53.975 2.1250	104.775 4.1250	39.688 1.5625	180000 40500	0.34	1.79	46800 10500	26800 6030	1.74		237000 53200	4595	4535
53.975 2.1250	107.950 4.2500	27.783 1.0938	161000 36100	0.34	1.79	41700 9370	23900 5380	1.74		166000 37200	456	453A
53.975 2.1250	107.950 4.2500	27.783 1.0938	161000 36100	0.34	1.79	41700 9370	23900 5380	1.74		166000 37200	456	453AS
53.975 2.1250	107.950 4.2500	27.795 1.0943	161000 36100	0.34	1.79	41700 9370	23900 5380	1.74		166000 37200	456	453
53.975 2.1250	107.950 4.2500	32.558 1.2818	161000 36100	0.34	1.79	41700 9370	23900 5380	1.74		166000 37200	456	452A
53.975 2.1250	107.950 4.2500	36.512 1.4375	204000 45900	0.30	2.02	52900 11900	26800 6040	1.97		206000 46200	539	532X
53.975 2.1250	107.950 4.2500	36.512 1.4375	204000 45900	0.30	2.02	52900 11900	26800 6040	1.97		206000 46200	539A	532X
53.975 2.1250	110.000 4.3307	27.783 1.0938	161000 36100	0.34	1.79	41700 9370	23900 5380	1.74		166000 37200	456	454
53.975 2.1250	110.000 4.3307	34.130 1.3437	204000 45900	0.30	2.02	52900 11900	26800 6040	1.97		206000 46200	539	534
53.975 2.1250	111.125 4.3750	38.100 1.5000	204000 45900	0.30	2.02	52900 11900	26800 6040	1.97		206000 46200	539A	532A
53.975 2.1250	111.125 4.3750	38.895 1.5313	180000 40500	0.34	1.79	46800 10500	26800 6030	1.74		237000 53200	4595	4536
53.975 2.1250	112.712 4.4375	30.162 1.1875	167000 37500	0.34	1.77	43300 9730	25100 5650	1.72		224000 50300	39578	39520
53.975 2.1250	117.475 4.6250	33.338 1.3125	177000 39700	0.63	0.96	45800 10300	49100 11000	0.93		166000 37300	66212	66461
53.975 2.1250	117.475 4.6250	33.338 1.3125	177000 39700	0.63	0.96	45800 10300	49100 11000	0.93		166000 37300	66212	66462

⁽¹⁾Based on 1 x 10⁶ revolutions L₁₀ life, for the ISO life-calculation method.

⁽²⁾Consult your Timken engineer for instructions on use or review the Timken Engineering Manual on timken.com/catalogs.

⁽³⁾Based on 90 x 10⁶ revolutions L₁₀ life, for The Timken Company life-calculation method. C₉₀ and C_{a90} are radial and thrust values.

Bearing Dimensions											Geometry Factors			Bearing Weight
Width B	Width C	Eff. Ctr. a ⁽⁴⁾	Shaft			Housing			Cage		G ₁	G ₂	C _g	
			Max Shaft Fillet Radius R ⁽⁵⁾	Backing Shoulder Dia. d _a d _b		Max Housing Fillet Radius r ⁽⁵⁾	Backing Shoulder Dia. D _a D _b		A _a ⁽⁶⁾	A _b ⁽⁷⁾				
mm in.	mm in.	mm in.	mm in.	mm in.	mm in.	mm in.	mm in.	mm in.	mm in.	mm in.				kg lbs.
36.512 1.4375	28.575 1.1250	-7.4 -0.29	3.5 0.14	63.1 2.48	73.0 2.87	3.3 0.13	100.0 3.94	89.0 3.50	3.4 0.13	2.0 0.08	63.9	17.1	0.0760	1.40 3.08
36.512 1.4375	28.575 1.1250	-7.4 -0.29	3.5 0.14	63.1 2.48	73.0 2.87	0.8 0.03	100.0 3.94	91.0 3.58	3.4 0.13	2.0 0.08	63.9	17.1	0.0760	1.40 3.08
36.512 1.4375	28.575 1.1250	-7.4 -0.29	1.5 0.06	63.1 2.48	69.0 2.72	0.8 0.03	100.0 3.94	91.0 3.58	3.4 0.13	2.0 0.08	63.9	17.1	0.0760	1.39 3.07
40.157 1.5810	33.338 1.3125	-12.4 -0.49	3.5 0.14	63.0 2.48	70.0 2.76	3.3 0.13	99.0 3.90	90.0 3.54	1.6 0.06	1.3 0.05	73.6	20.2	0.1027	1.54 3.39
29.317 1.1542	22.225 0.8750	-7.1 -0.28	3.5 0.14	61.0 2.40	68.0 2.68	0.8 0.03	100.0 3.94	97.0 3.82	2.1 0.08	1.4 0.06	58.6	17.1	0.0946	1.16 2.55
29.317 1.1542	22.225 0.8750	-7.1 -0.28	3.5 0.14	61.0 2.40	68.0 2.68	2.3 0.09	100.0 3.94	95.0 3.74	2.1 0.08	1.4 0.06	58.6	17.1	0.0946	1.16 2.55
29.317 1.1542	27.000 1.0630	-7.1 -0.28	3.5 0.14	61.0 2.40	68.0 2.68	0.8 0.03	100.0 3.94	97.0 3.82	2.1 0.08	1.4 0.06	58.6	17.1	0.0946	1.22 2.68
29.317 1.1542	27.000 1.0630	-7.1 -0.28	3.5 0.14	61.0 2.40	68.0 2.68	3.3 0.13	100.0 3.94	93.0 3.66	2.1 0.08	1.4 0.06	58.6	17.1	0.0946	1.27 2.79
36.957 1.4550	28.575 1.1250	-12.2 -0.48	3.5 0.14	61.0 2.40	68.0 2.68	3.3 0.13	100.0 3.94	94.0 3.70	2.7 0.10	1.0 0.04	64.3	16.1	0.0938	1.44 3.19
36.957 1.4550	28.575 1.1250	-12.2 -0.48	5.5 0.22	61.0 2.40	72.0 2.83	3.3 0.13	100.0 3.94	94.0 3.70	2.7 0.10	1.0 0.04	64.3	16.1	0.0938	1.43 3.16
29.317 1.1542	27.000 1.0630	-7.1 -0.28	3.5 0.14	61.0 2.40	68.0 2.68	2.0 0.08	100.0 3.94	96.0 3.78	2.1 0.08	1.4 0.06	58.6	17.1	0.0946	1.29 2.83
36.957 1.4550	26.988 1.0625	-12.2 -0.48	3.5 0.14	61.0 2.40	68.0 2.68	3.3 0.13	100.0 3.94	94.0 3.70	2.7 0.10	1.0 0.04	64.3	16.1	0.0938	1.47 3.24
36.957 1.4550	30.162 1.1875	-12.2 -0.48	5.5 0.22	61.0 2.40	72.0 2.83	3.3 0.13	100.0 3.94	95.0 3.74	2.7 0.10	1.0 0.04	64.3	16.1	0.0938	1.61 3.53
40.157 1.5810	32.545 1.2813	-12.4 -0.49	3.5 0.14	63.0 2.48	70.0 2.76	3.3 0.13	100.0 3.94	93.0 3.66	1.6 0.06	1.3 0.05	73.6	20.2	0.1027	1.80 3.95
30.162 1.1875	23.812 0.9375	-6.6 -0.26	3.5 0.14	64.0 2.52	70.0 2.76	3.3 0.13	107.0 4.21	101.0 3.98	1.6 0.06	2.7 0.11	84.3	23.7	0.1074	1.44 3.18
31.750 1.2500	23.812 0.9375	-0.3 -0.01	3.5 0.14	67.0 2.64	73.0 2.87	0.8 0.03	111.0 4.37	102.0 4.02	5.0 0.19	2.0 0.08	50.2	16.4	0.0751	1.58 3.50
31.750 1.2500	23.812 0.9375	-0.3 -0.01	3.5 0.14	67.0 2.64	73.0 2.87	3.3 0.13	111.0 4.37	100.0 3.94	5.0 0.19	2.0 0.08	50.2	16.4	0.0751	1.57 3.46

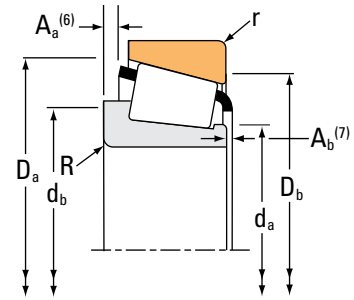
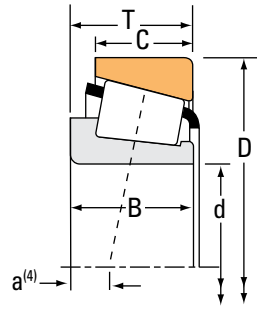
(4) Negative value indicates effective center inside cone (inner-ring) backface.
 (5) These maximum fillet radii will be cleared by the bearing corners.
 (6) Negative value indicates cage extends beyond cone (inner-ring) backface.
 (7) Negative value indicates cage that does not extend beyond cone (inner-ring) front face.

Continued on next page.

TAPERED ROLLER BEARINGS

SINGLE-ROW • TYPE TS

TYPE TS



Bearing Dimensions			Load Ratings							Part Number			
Bore d	O.D. D	Width T	Dynamic ⁽¹⁾		Factors ⁽²⁾		Dynamic ⁽³⁾		Factors ⁽²⁾		Static C ₀	Inner	Outer
			C ₁	e	Y	C ₉₀	C _{a90}	K	N	N			
mm in.	mm in.	mm in.	N lbf			N lbf	N lbf		N lbf				
53.975 2.1250	120.650 4.7500	41.275 1.6250	207000 46600	0.31	1.91	53800 12100	28900 6510	1.86	244000 54800		621	612	
53.975 2.1250	120.650 4.7500	41.275 1.6250	207000 46600	0.31	1.91	53800 12100	28900 6510	1.86	244000 54800		624	612	
53.975 2.1250	120.650 4.7500	41.275 1.6250	207000 46600	0.31	1.91	53800 12100	28900 6510	1.86	244000 54800		621	612-S	
53.975 2.1250	122.238 4.8125	33.338 1.3125	183000 41200	0.67	0.90	47500 10700	54100 12200	0.88	178000 39900		66584	66520	
53.975 2.1250	122.238 4.8125	43.658 1.7188	237000 53200	0.36	1.67	61300 13800	37600 8460	1.63	327000 73500		5578	5535	
53.975 2.1250	122.238 4.8125	43.658 1.7188	237000 53200	0.36	1.67	61300 13800	37600 8460	1.63	327000 73500		5577	5535	
53.975 2.1250	123.825 4.8750	36.512 1.4375	214000 48200	0.74	0.81	55500 12500	70100 15800	0.79	208000 46800		72212C	72487	
53.975 2.1250	123.825 4.8750	36.512 1.4375	214000 48200	0.74	0.81	55500 12500	70100 15800	0.79	208000 46800		72213C	72487	
53.975 2.1250	123.825 4.8750	38.100 1.5000	226000 50800	0.35	1.73	58600 13200	34700 7810	1.69	248000 55700		557-S	552A	
53.975 2.1250	127.000 5.0000	36.512 1.4375	214000 48200	0.74	0.81	55500 12500	70100 15800	0.79	208000 46800		72213C	72500	
53.975 2.1250	127.000 5.0000	44.450 1.7500	243000 54700	0.49	1.23	63100 14200	52700 11800	1.20	297000 66700		65212	65500	
53.975 2.1250	127.000 5.0000	50.800 2.0000	306000 68800	0.30	2.01	79300 17800	40500 9110	1.96	370000 83300		6280	6220	
53.975 2.1250	130.175 5.1250	34.100 1.3425	167000 37500	0.82	0.73	43200 9720	60700 13600	0.71	183000 41100		HM911243	HM911210	
53.975 2.1250	130.175 5.1250	36.512 1.4375	198000 44400	0.82	0.73	51200 11500	71900 16200	0.71	183000 41100		HM911242	HM911210	
53.975 2.1250	134.983 5.3143	33.449 1.3169	167000 37500	0.82	0.73	43200 9720	60700 13600	0.71	183000 41100		HM911243	HM911216	
53.975 2.1250	136.525 5.3750	36.512 1.4375	237000 53200	0.87	0.69	61300 13800	90900 20400	0.67	234000 52600		78215C	78537	
53.975 2.1250	136.525 5.3750	41.275 1.6250	276000 62100	0.36	1.66	71600 16100	44400 9980	1.61	298000 67000		636	632	

⁽¹⁾Based on 1 x 10⁶ revolutions L₁₀ life, for the ISO life-calculation method.

⁽²⁾Consult your Timken engineer for instructions on use or review the Timken Engineering Manual on timken.com/catalogs.

⁽³⁾Based on 90 x 10⁶ revolutions L₁₀ life, for The Timken Company life-calculation method. C₉₀ and C_{a90} are radial and thrust values.

Bearing Dimensions											Geometry Factors			Bearing Weight
Width B	Width C	Eff. Ctr. a ⁽⁴⁾	Shaft			Housing			Cage		G ₁	G ₂	C _g	
			Max Shaft Fillet Radius R ⁽⁵⁾	Backing Shoulder Dia. d _a	Shoulder Dia. d _b	Max Housing Fillet Radius r ⁽⁵⁾	Backing Shoulder Dia. D _a	Shoulder Dia. D _b	A _a ⁽⁶⁾	A _b ⁽⁷⁾				
mm in.	mm in.	mm in.	mm in.	mm in.	mm in.	mm in.	mm in.	mm in.	mm in.	mm in.				kg lbs.
41.275 1.6250	31.750 1.2500	-14.0 -0.55	3.5 0.14	63.0 2.48	70.0 2.76	3.3 0.13	110.0 4.33	105.0 4.13	3.8 0.15	1.9 0.08	75.9	16.2	0.0694	2.18 4.82
41.275 1.6250	31.750 1.2500	-14.0 -0.55	0.8 0.03	63.0 2.48	64.0 2.52	3.3 0.13	110.0 4.33	105.0 4.13	3.8 0.15	1.9 0.08	75.9	16.2	0.0694	2.19 4.84
41.275 1.6250	31.750 1.2500	-14.0 -0.55	3.5 0.14	63.0 2.48	70.0 2.76	0.8 0.03	110.0 4.33	107.0 4.21	3.8 0.15	1.9 0.08	75.9	16.2	0.0694	2.19 4.85
31.750 1.2500	23.812 0.9375	2.0 0.08	3.5 0.14	68.0 2.68	75.0 2.95	3.3 0.13	116.0 4.57	105.0 4.13	5.2 0.20	2.0 0.08	57.0	18.3	0.0797	1.76 3.89
43.764 1.7230	36.512 1.4375	-12.2 -0.48	3.5 0.14	67.0 2.64	73.0 2.87	3.3 0.13	116.0 4.57	106.0 4.17	2.5 0.09	1.3 0.05	110.4	24.2	0.0825	2.58 5.71
43.764 1.7230	36.512 1.4375	-12.2 -0.48	1.3 0.05	67.0 2.64	69.0 2.72	3.3 0.13	116.0 4.57	106.0 4.17	2.5 0.09	1.3 0.05	110.4	24.2	0.0825	2.59 5.72
32.791 1.2910	25.400 1.0000	2.0 0.08	3.5 0.14	67.0 2.64	79.0 3.11	3.3 0.13	116.0 4.57	102.0 4.02	4.7 0.18	4.4 0.18	57.4	15.9	0.0825	2.03 4.48
32.791 1.2910	25.400 1.0000	2.0 0.08	3.5 0.14	67.0 2.64	79.0 3.11	3.3 0.13	116.0 4.57	102.0 4.02	4.7 0.18	4.4 0.18	57.4	15.9	0.0825	2.05 4.53
36.678 1.4440	30.162 1.1875	-9.4 -0.37	3.5 0.14	67.0 2.64	73.0 2.87	3.3 0.13	116.0 4.57	109.0 4.29	2.3 0.09	1.3 0.05	91.0	21.1	0.1108	2.24 4.93
32.791 1.2910	25.400 1.0000	2.0 0.08	3.5 0.14	67.0 2.64	79.0 3.11	3.3 0.13	116.0 4.57	103.0 4.06	4.7 0.18	4.4 0.18	57.4	15.9	0.0825	2.16 4.78
44.450 1.7500	34.925 1.3750	-9.4 -0.37	3.5 0.14	71.0 2.80	77.0 3.03	3.3 0.13	119.0 4.69	107.0 4.21	4.1 0.16	1.1 0.05	83.2	17.2	0.0827	2.81 6.18
52.388 2.0625	41.275 1.6250	-19.6 -0.77	3.5 0.14	67.0 2.64	74.0 2.91	3.3 0.13	117.0 4.61	108.0 4.25	2.3 0.09	2.6 0.11	103.1	18.7	0.0757	3.26 7.19
30.924 1.2175	23.812 0.9375	7.9 0.31	3.5 0.14	74.0 2.91	79.0 3.11	3.3 0.13	123.6 4.87	109.0 4.29	4.9 0.19	4.3 0.17	56.4	16.5	0.0842	2.12 4.69
33.338 1.3125	23.812 0.9375	5.3 0.21	3.5 0.14	74.0 2.91	79.0 3.11	3.3 0.13	123.6 4.87	109.0 4.29	7.3 0.29	4.3 0.17	56.4	16.5	0.0842	2.22 4.90
30.924 1.2175	21.948 0.8641	7.9 0.31	3.5 0.14	74.0 2.91	79.0 3.11	3.5 0.14	123.0 4.84	112.0 4.41	4.9 0.19	4.3 0.17	56.4	16.5	0.0842	2.25 4.96
33.236 1.3085	23.520 0.9260	8.4 0.33	3.5 0.14	77.5 3.05	84.0 3.31	3.3 0.13	130.0 5.12	115.0 4.53	6.3 0.25	4.9 0.20	71.3	17.6	0.0926	2.60 5.72
41.275 1.6250	31.750 1.2500	-11.2 -0.44	3.5 0.14	67.0 2.64	73.0 2.87	3.3 0.13	125.0 4.92	118.0 4.65	4.1 0.16	2.0 0.08	106.4	21.0	0.0814	3.11 6.86

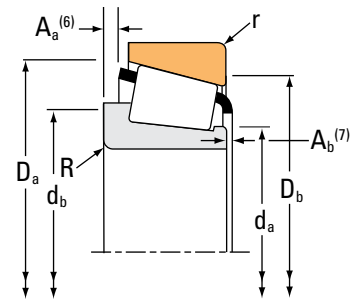
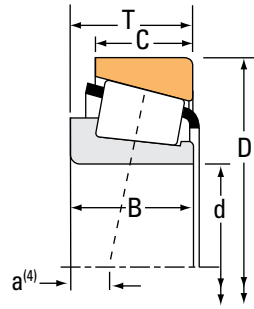
⁽⁴⁾Negative value indicates effective center inside cone (inner-ring) backface.
⁽⁵⁾These maximum fillet radii will be cleared by the bearing corners.
⁽⁶⁾Negative value indicates cage extends beyond cone (inner-ring) backface.
⁽⁷⁾Negative value indicates cage that does not extend beyond cone (inner-ring) front face.

Continued on next page.

TAPERED ROLLER BEARINGS

SINGLE-ROW • TYPE TS

TYPE TS



Bearing Dimensions			Load Ratings							Part Number			
Bore d	O.D. D	Width T	Dynamic ⁽¹⁾		Factors ⁽²⁾		Dynamic ⁽³⁾		Factors ⁽²⁾		Static C ₀	Inner	Outer
			C ₁	e	Y	C ₉₀	C _{a90}	K	N	N			
mm in.	mm in.	mm in.	N lbf			N lbf	N lbf		N lbf				
53.975 2.1250	140.030 5.5130	36.512 1.4375	237000 53200	0.87	0.69	61300 13800	90900 20400	0.67	234000 52600		78215C	78551	
53.975 2.1250	140.030 5.5130	36.512 1.4375	237000 53200	0.87	0.69	61300 13800	90900 20400	0.67	234000 52600		78214C	78551	
54.487 2.1452	104.775 4.1250	36.512 1.4375	203000 45700	0.49	1.23	52700 11900	44000 9890	1.20	223000 50200		HM807048	HM807010	
54.987 2.1649	103.188 4.0625	38.100 1.5000	172000 38700	0.30	2.02	44600 10000	22700 5090	1.97	206000 46200		538	533A	
54.987 2.1649	110.000 4.3307	38.100 1.5000	172000 38700	0.30	2.02	44600 10000	22700 5090	1.97	206000 46200		538	533X	
54.987 2.1649	135.755 5.3447	53.975 2.1250	321000 72300	0.32	1.85	83300 18700	46300 10400	1.80	404000 90900		6381	6320	
55.000 2.1654	90.000 3.5433	23.000 0.9055	109000 24500	0.40	1.49	28200 6340	19400 4370	1.45	123000 27600		JLM506849A	JLM506810	
55.000 2.1654	90.000 3.5433	23.000 0.9055	109000 24500	0.40	1.49	28200 6340	19400 4370	1.45	123000 27600		JLM506849	JLM506810	
55.000 2.1654	90.000 3.5433	25.000 0.9843	109000 24500	0.40	1.49	28200 6340	19400 4370	1.45	123000 27600		JLM506849A	JLM506811	
55.000 2.1654	95.000 3.7402	29.000 1.1417	131000 29300	0.33	1.79	33800 7610	19400 4360	1.74	168000 37700		JM207049	JM207010	
55.000 2.1654	95.000 3.7402	29.000 1.1417	131000 29300	0.33	1.79	33800 7610	19400 4360	1.74	168000 37700		JM207049A	JM207010	
55.000 2.1654	95.000 3.7402	30.000 1.1811	131000 29300	0.33	1.79	33800 7610	19400 4360	1.74	168000 37700		JM207049	JM207010A	
55.000 2.1654	96.838 3.8125	21.000 0.8268	108000 24200	0.35	1.69	28000 6280	16900 3810	1.65	107000 24100		385	382A	
55.000 2.1654	96.838 3.8125	21.000 0.8268	108000 24200	0.35	1.69	28000 6280	16900 3810	1.65	107000 24100		385X	382A	
55.000 2.1654	98.425 3.8750	21.000 0.8268	108000 24200	0.35	1.69	28000 6280	16900 3810	1.65	107000 24100		385	382	
55.000 2.1654	100.000 3.9370	21.000 0.8268	108000 24200	0.35	1.69	28000 6280	16900 3810	1.65	107000 24100		385	383A	
55.000 2.1654	110.000 4.3307	39.000 1.5354	249000 56000	0.35	1.73	64500 14500	38300 8600	1.69	251000 56500		JH307749	JH307710	

⁽¹⁾Based on 1 x 10⁶ revolutions L₁₀ life, for the ISO life-calculation method.

⁽²⁾Consult your Timken engineer for instructions on use or review the Timken Engineering Manual on timken.com/catalogs.

⁽³⁾Based on 90 x 10⁶ revolutions L₁₀ life, for The Timken Company life-calculation method. C₉₀ and C_{a90} are radial and thrust values.

Bearing Dimensions											Geometry Factors			Bearing Weight
Width B	Width C	Eff. Ctr. a ⁽⁴⁾	Shaft			Housing			Cage		G ₁	G ₂	C _g	
			Max Shaft Fillet Radius R ⁽⁵⁾	Backing Shoulder Dia. d _a	Shoulder Dia. d _b	Max Housing Fillet Radius r ⁽⁵⁾	Backing Shoulder Dia. D _a	Shoulder Dia. D _b	A _a ⁽⁶⁾	A _b ⁽⁷⁾				
mm in.	mm in.	mm in.	mm in.	mm in.	mm in.	mm in.	mm in.	mm in.	mm in.	mm in.				kg lbs.
33.236 1.3085	23.520 0.9260	8.4 0.33	3.5 0.14	77.5 3.05	84.0 3.31	2.3 0.09	132.0 5.20	117.0 4.61	6.3 0.25	4.9 0.20	71.3	17.6	0.0926	2.74 6.04
33.236 1.3085	23.520 0.9260	8.4 0.33	0.8 0.03	0.0 3.05	0.0 3.11	2.3 0.09	132.0 5.20	117.0 4.61	6.3 0.25	4.9 0.20	71.3	17.6	0.0926	2.74 6.06
36.512 1.4375	28.575 1.1250	-7.4 -0.29	3.5 0.14	63.0 2.48	73.0 2.87	3.3 0.13	100.0 3.94	89.0 3.50	3.4 0.13	2.0 0.08	63.9	17.1	0.0760	1.37 3.02
36.957 1.4550	30.162 1.1875	-12.2 -0.48	0.8 0.03	62.0 2.44	63.0 2.48	1.5 0.06	98.0 3.86	93.0 3.66	2.7 0.10	1.0 0.04	64.3	16.1	0.0938	1.29 2.86
36.957 1.4550	30.162 1.1875	-12.2 -0.48	0.8 0.03	62.0 2.44	63.0 2.48	3.3 0.13	100.0 3.94	95.0 3.74	2.7 0.10	1.0 0.04	64.3	16.1	0.0938	1.55 3.43
56.007 2.2050	44.450 1.7500	-19.3 -0.76	3.5 0.14	70.0 2.76	76.0 2.99	3.3 0.13	126.0 4.96	117.0 4.61	4.0 0.15	0.5 0.02	123.5	22.4	0.0827	4.05 8.93
23.000 0.9055	18.500 0.7283	-2.8 -0.11	3.5 0.14	60.0 2.36	67.0 2.64	0.5 0.02	86.0 3.39	82.0 3.23	1.0 0.04	1.6 0.06	45.6	20.4	0.0925	0.54 1.20
23.000 0.9055	18.500 0.7283	-2.8 -0.11	1.5 0.06	61.0 2.40	63.0 2.48	0.5 0.02	86.0 3.39	82.0 3.23	1.0 0.04	1.6 0.06	45.6	20.4	0.0925	0.54 1.21
23.000 0.9055	20.500 0.8071	-2.8 -0.11	3.5 0.14	60.0 2.36	67.0 2.64	0.5 0.02	86.0 3.39	82.0 3.23	1.0 0.04	1.6 0.06	45.6	20.4	0.0925	0.58 1.27
29.000 1.1417	23.500 0.9252	-7.6 -0.30	1.5 0.06	62.0 2.44	64.0 2.52	2.5 0.10	91.0 3.58	85.0 3.35	1.3 0.05	2.4 0.10	56.4	19.9	0.0937	0.83 1.84
29.000 1.1417	23.500 0.9252	-7.6 -0.30	6.0 0.24	62.0 2.44	73.0 2.87	2.5 0.10	91.0 3.58	85.0 3.35	1.3 0.05	2.4 0.10	56.4	19.9	0.0937	0.80 1.79
29.000 1.1417	24.500 0.9646	-7.6 -0.30	1.5 0.06	62.0 2.44	64.0 2.52	2.0 0.08	91.0 3.58	87.0 3.43	1.3 0.05	2.4 0.10	56.4	19.9	0.0937	0.86 1.90
21.946 0.8640	15.875 0.6250	-3.0 -0.12	2.3 0.09	61.0 2.40	65.0 2.56	0.8 0.03	92.0 3.62	89.0 3.50	1.1 0.04	2.0 0.08	42.0	15.7	0.0859	0.62 1.38
21.946 0.8640	15.875 0.6250	-3.0 -0.12	3.5 0.14	61.0 2.40	67.0 2.64	0.8 0.03	92.0 3.62	89.0 3.50	1.1 0.04	2.0 0.08	42.0	15.7	0.0859	0.62 1.37
21.946 0.8640	17.826 0.7018	-3.0 -0.12	2.3 0.09	61.0 2.40	65.0 2.56	0.8 0.03	92.0 3.62	90.0 3.54	1.1 0.04	2.0 0.08	42.0	15.7	0.0859	0.67 1.48
21.946 0.8640	17.826 0.7018	-3.0 -0.12	2.3 0.09	61.0 2.40	65.0 2.56	2.0 0.08	93.0 3.66	89.0 3.50	1.1 0.04	2.0 0.08	42.0	15.7	0.0859	0.70 1.55
39.000 1.5354	32.000 1.2598	-11.7 -0.46	3.0 0.12	64.0 2.52	71.0 2.80	2.5 0.10	104.0 4.09	97.0 3.82	0.8 0.03	3.1 0.13	72.0	16.9	0.0706	1.69 3.71

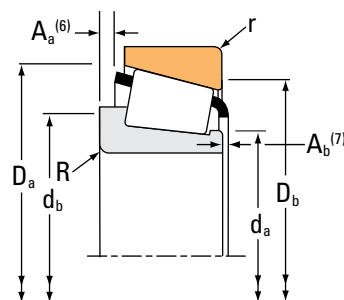
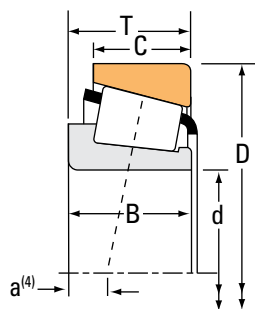
⁽⁴⁾Negative value indicates effective center inside cone (inner-ring) backface.
⁽⁵⁾These maximum fillet radii will be cleared by the bearing corners.
⁽⁶⁾Negative value indicates cage extends beyond cone (inner-ring) backface.
⁽⁷⁾Negative value indicates cage that does not extend beyond cone (inner-ring) front face.

Continued on next page.

TAPERED ROLLER BEARINGS

SINGLE-ROW • TYPE TS

TYPE TS



Bearing Dimensions			Load Ratings							Part Number		
Bore d	O.D. D	Width T	Dynamic ⁽¹⁾		Factors ⁽²⁾		Dynamic ⁽³⁾		Factors ⁽²⁾	Static	Inner	Outer
			C ₁	e	Y	C ₉₀	C _{a90}	K	C ₀			
mm in.	mm in.	mm in.	N lbf			N lbf	N lbf			N lbf		
55.000 2.1654	115.000 4.5276	34.000 1.3386	172000 38700	0.87	0.69	44600 10000	66200 14900	0.67		175000 39200	JW5549	JW5510
55.000 2.1654	115.000 4.5276	41.021 1.6150	207000 46600	0.31	1.91	53800 12100	28900 6510	1.86		244000 54800	622X	614X
55.000 2.1654	120.000 4.7244	29.002 1.1418	143000 32200	0.38	1.56	37200 8360	24500 5500	1.52		186000 41900	475	472A
55.000 2.1654	120.000 4.7244	29.794 1.1730	143000 32200	0.38	1.56	37200 8360	24500 5500	1.52		186000 41900	475	472
55.000 2.1654	120.000 4.7244	29.794 1.1730	143000 32200	0.38	1.56	37200 8360	24500 5500	1.52		186000 41900	475	473
55.000 2.1654	123.825 4.8750	38.100 1.5000	191000 42900	0.35	1.73	49400 11100	29300 6590	1.69		248000 55700	557	552A
55.006 2.1656	120.040 4.7260	41.275 1.6250	207000 46600	0.31	1.91	53800 12100	28900 6510	1.86		244000 54800	622A	612A
55.562 2.1875	97.630 3.8437	24.608 0.9688	123000 27700	0.40	1.49	32000 7180	22000 4950	1.45		142000 32000	28680	28622
55.562 2.1875	107.950 4.2500	27.783 1.0938	161000 36100	0.34	1.79	41700 9370	23900 5380	1.74		166000 37200	466-S	453A
55.562 2.1875	107.950 4.2500	27.783 1.0938	161000 36100	0.34	1.79	41700 9370	23900 5380	1.74		166000 37200	466-S	453AS
55.562 2.1875	122.238 4.8125	43.658 1.7188	237000 53200	0.36	1.67	61300 13800	37600 8460	1.63		327000 73500	5566	5535
55.562 2.1875	123.825 4.8750	36.512 1.4375	214000 48200	0.74	0.81	55500 12500	70100 15800	0.79		208000 46800	72218C	72487
55.562 2.1875	123.825 4.8750	36.512 1.4375	214000 48200	0.74	0.81	55500 12500	70100 15800	0.79		208000 46800	72219C	72487
55.562 2.1875	127.000 5.0000	36.512 1.4375	229000 51500	0.50	1.20	59400 13400	51100 11500	1.16		256000 57600	HM813840	HM813811
55.562 2.1875	127.000 5.0000	36.512 1.4375	229000 51500	0.50	1.20	59400 13400	51100 11500	1.16		256000 57600	HM813840	HM813810
55.575 2.1880	96.838 3.8125	21.000 0.8268	108000 24200	0.35	1.69	28000 6280	16900 3810	1.65		107000 24100	389	382A
55.575 2.1880	100.000 3.9370	20.980 0.8268	108000 24200	0.35	1.69	28000 6280	16900 3810	1.65		107000 24100	389	383A

⁽¹⁾Based on 1 x 10⁶ revolutions L₁₀ life, for the ISO life-calculation method.

⁽²⁾Consult your Timken engineer for instructions on use or review the Timken Engineering Manual on timken.com/catalogs.

⁽³⁾Based on 90 x 10⁶ revolutions L₁₀ life, for The Timken Company life-calculation method. C₉₀ and C_{a90} are radial and thrust values.

Bearing Dimensions											Geometry Factors			Bearing Weight
Width B	Width C	Eff. Ctr. a ⁽⁴⁾	Shaft			Housing			Cage		G ₁	G ₂	C _g	
			Max Shaft Fillet Radius R ⁽⁵⁾	Backing Shoulder Dia. d _a	Backing Shoulder Dia. d _b	Max Housing Fillet Radius r ⁽⁵⁾	Backing Shoulder Dia. D _a	Backing Shoulder Dia. D _b	A _a ⁽⁶⁾	A _b ⁽⁷⁾				
mm in.	mm in.	mm in.	mm in.	mm in.	mm in.	mm in.	mm in.	mm in.	mm in.	mm in.				kg lbs.
31.000 1.2205	23.500 0.9252	5.8 0.23	3.0 0.12	66.0 2.59	78.0 3.07	3.0 0.12	109.0 4.29	95.0 3.74	5.2 0.20	3.8 0.15	51.1	15.8	0.0831	1.57 3.46
41.275 1.6250	31.496 1.2400	-14.0 -0.55	3.0 0.12	64.0 2.52	70.0 2.76	3.0 0.12	108.0 4.25	101.0 3.98	3.8 0.15	1.9 0.08	75.9	16.2	0.0694	1.90 4.18
29.007 1.1420	23.444 0.9230	-4.1 -0.16	0.8 0.03	66.0 2.60	67.0 2.64	3.3 0.13	114.0 4.49	106.0 4.17	1.5 0.05	2.2 0.09	77.2	23.0	0.1083	1.62 3.57
29.007 1.1420	24.237 0.9542	-4.1 -0.16	0.8 0.03	66.0 2.60	67.0 2.64	2.0 0.08	114.0 4.49	107.0 4.21	1.5 0.05	2.2 0.09	77.2	23.0	0.1083	1.65 3.64
29.007 1.1420	29.000 1.1417	-4.1 -0.16	0.8 0.03	66.0 2.60	67.0 2.64	2.0 0.08	114.0 4.49	107.0 4.21	1.5 0.05	2.2 0.09	77.2	23.0	0.1083	1.70 3.75
36.678 1.4440	30.162 1.1875	-9.4 -0.37	3.5 0.14	66.0 2.60	72.0 2.83	3.3 0.13	116.0 4.57	109.0 4.29	2.3 0.09	1.3 0.05	91.0	21.1	0.1108	2.21 4.86
41.275 1.6250	31.750 1.2500	-14.0 -0.55	0.8 0.03	64.0 2.52	65.0 2.56	3.3 0.13	110.0 4.33	103.0 4.06	3.8 0.15	1.9 0.08	75.9	16.2	0.0694	2.13 4.72
24.608 0.9688	19.446 0.7656	-3.3 -0.13	3.5 0.14	62.0 2.44	68.0 2.68	0.8 0.03	92.0 3.62	88.0 3.46	1.5 0.06	1.8 0.08	54.0	22.6	0.0979	0.75 1.67
29.317 1.1542	22.225 0.8750	-7.1 -0.28	2.3 0.09	62.0 2.44	66.0 2.60	0.8 0.03	100.0 3.94	97.0 3.82	2.1 0.08	1.4 0.06	58.6	17.1	0.0946	1.13 2.50
29.317 1.1542	22.225 0.8750	-7.1 -0.28	2.3 0.09	62.0 2.44	66.0 2.60	2.3 0.09	100.0 3.94	95.0 3.74	2.1 0.08	1.4 0.06	58.6	17.1	0.0946	1.13 2.49
43.764 1.7230	36.512 1.4375	-12.2 -0.48	1.3 0.05	68.0 2.68	70.0 2.76	3.3 0.13	116.0 4.57	106.0 4.17	2.5 0.09	1.3 0.05	110.4	24.2	0.0825	2.54 5.62
32.791 1.2910	25.400 1.0000	2.0 0.08	3.5 0.14	67.0 2.64	80.0 3.15	3.3 0.13	116.0 4.57	102.0 4.02	4.7 0.18	4.4 0.18	57.4	15.9	0.0825	2.01 4.45
32.791 1.2910	25.400 1.0000	2.0 0.08	3.5 0.14	67.0 2.64	80.0 3.15	3.3 0.13	116.0 4.57	102.0 4.02	4.7 0.18	4.4 0.18	57.4	15.9	0.0825	2.01 4.45
36.512 1.4375	26.988 1.0625	-3.8 -0.15	3.5 0.14	72.0 2.83	78.0 3.07	1.5 0.06	121.0 4.76	113.0 4.45	4.0 0.15	1.3 0.06	91.7	22.9	0.1252	2.30 5.08
36.512 1.4375	26.988 1.0625	-3.8 -0.15	3.5 0.14	72.0 2.83	78.0 3.07	3.3 0.13	121.0 4.76	111.0 4.37	4.0 0.15	1.3 0.06	91.7	22.9	0.1252	2.30 5.08
21.946 0.8640	15.875 0.6250	-3.0 -0.12	2.3 0.09	61.0 2.40	65.0 2.56	0.8 0.03	92.0 3.62	89.0 3.50	1.1 0.04	2.0 0.08	42.0	15.7	0.0859	0.61 1.35
21.946 0.8640	17.826 0.7018	-3.0 -0.12	2.3 0.09	61.0 2.40	65.0 2.56	2.0 0.08	93.0 3.66	89.0 3.50	1.1 0.04	2.0 0.08	42.0	15.7	0.0859	0.69 1.53

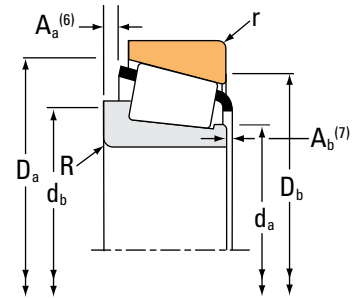
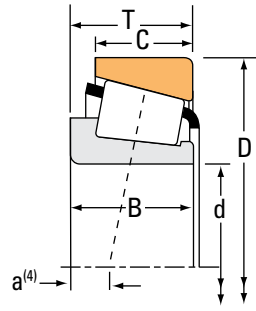
(4) Negative value indicates effective center inside cone (inner-ring) backface.
 (5) These maximum fillet radii will be cleared by the bearing corners.
 (6) Negative value indicates cage extends beyond cone (inner-ring) backface.
 (7) Negative value indicates cage that does not extend beyond cone (inner-ring) front face.

Continued on next page.

TAPERED ROLLER BEARINGS

SINGLE-ROW • TYPE TS

TYPE TS



Bearing Dimensions			Load Ratings							Part Number			
Bore d	O.D. D	Width T	Dynamic ⁽¹⁾		Factors ⁽²⁾		Dynamic ⁽³⁾		Factors ⁽²⁾		Static C ₀	Inner	Outer
			C ₁	e	Y	C ₉₀	C _{a90}	K	N	N			
mm in.	mm in.	mm in.	N lbf			N lbf	N lbf		N lbf				
57.150 2.2500	87.312 3.4375	18.258 0.7188	62700 14100	0.39	1.54	16300 3650	10800 2430	1.50	95600 21500		L507949	L507910	
57.150 2.2500	96.838 3.8125	21.000 0.8268	108000 24200	0.35	1.69	28000 6280	16900 3810	1.65	107000 24100		387	382A	
57.150 2.2500	96.838 3.8125	21.000 0.8268	108000 24200	0.35	1.69	28000 6280	16900 3810	1.65	107000 24100		387A	382A	
57.150 2.2500	96.838 3.8125	21.000 0.8268	108000 24200	0.35	1.69	28000 6280	16900 3810	1.65	107000 24100		387-S	382A	
57.150 2.2500	96.838 3.8125	21.001 0.8268	108000 24200	0.35	1.69	28000 6280	16900 3810	1.65	107000 24100		387AS	382A	
57.150 2.2500	96.838 3.8125	24.608 0.9688	123000 27700	0.40	1.49	32000 7180	22000 4950	1.45	142000 32000		28682	28621	
57.150 2.2500	96.838 3.8125	25.400 1.0000	108000 24200	0.35	1.69	28000 6280	16900 3810	1.65	107000 24100		387A	382-S	
57.150 2.2500	97.630 3.8437	24.608 0.9688	123000 27700	0.40	1.49	32000 7180	22000 4950	1.45	142000 32000		28682	28622	
57.150 2.2500	98.425 3.8750	21.000 0.8268	108000 24200	0.35	1.69	28000 6280	16900 3810	1.65	107000 24100		387	382	
57.150 2.2500	98.425 3.8750	21.000 0.8268	108000 24200	0.35	1.69	28000 6280	16900 3810	1.65	107000 24100		387A	382	
57.150 2.2500	98.425 3.8750	21.000 0.8268	108000 24200	0.35	1.69	28000 6280	16900 3810	1.65	107000 24100		387-S	382	
57.150 2.2500	98.425 3.8750	21.000 0.8268	108000 24200	0.35	1.69	28000 6280	16900 3810	1.65	107000 24100		387AS	382	
57.150 2.2500	98.425 3.8750	24.608 0.9688	123000 27700	0.40	1.49	32000 7180	22000 4950	1.45	142000 32000		28682	28623	
57.150 2.2500	100.000 3.9370	21.000 0.8268	108000 24200	0.35	1.69	28000 6280	16900 3810	1.65	107000 24100		387A	383A	
57.150 2.2500	100.000 3.9370	25.400 1.0000	108000 24200	0.35	1.69	28000 6280	16900 3810	1.65	107000 24100		387	383X	
57.150 2.2500	104.775 4.1250	30.162 1.1875	161000 36100	0.34	1.79	41700 9370	23900 5380	1.74	166000 37200		462	453X	
57.150 2.2500	104.775 4.1250	30.162 1.1875	161000 36100	0.34	1.79	41700 9370	23900 5380	1.74	166000 37200		469	453X	

⁽¹⁾Based on 1 x 10⁶ revolutions L₁₀ life, for the ISO life-calculation method.

⁽²⁾Consult your Timken engineer for instructions on use or review the Timken Engineering Manual on timken.com/catalogs.

⁽³⁾Based on 90 x 10⁶ revolutions L₁₀ life, for The Timken Company life-calculation method. C₉₀ and C_{a90} are radial and thrust values.

Bearing Dimensions											Geometry Factors			Bearing Weight
Width B	Width C	Eff. Ctr. a ⁽⁴⁾	Shaft			Housing			Cage		G ₁	G ₂	C _g	
			Max Shaft Fillet Radius R ⁽⁵⁾	Backing Shoulder Dia. d _a d _b		Max Housing Fillet Radius r ⁽⁵⁾	Backing Shoulder Dia. D _a D _b		A _a ⁽⁶⁾	A _b ⁽⁷⁾				
mm in.	mm in.	mm in.	mm in.	mm in.	mm in.	mm in.	mm in.	mm in.	mm in.	mm in.				kg lbs.
18.258 0.7188	14.288 0.5625	-0.8 -0.03	1.5 0.06	62.0 2.44	65.0 2.56	1.5 0.06	83.0 3.27	79.0 3.11	0.3 0.01	2.0 0.08	46.1	38.5	0.0914	0.39 0.85
21.946 0.8640	15.875 0.6250	-3.0 -0.12	2.3 0.09	63.0 2.48	67.0 2.64	0.8 0.03	92.0 3.62	89.0 3.50	1.1 0.04	2.0 0.08	42.0	15.7	0.0859	0.59 1.30
21.946 0.8640	15.875 0.6250	-3.0 -0.12	3.5 0.14	63.0 2.48	70.0 2.76	0.8 0.03	92.0 3.62	89.0 3.50	1.1 0.04	2.0 0.08	42.0	15.7	0.0859	0.59 1.30
21.946 0.8640	15.875 0.6250	-3.0 -0.12	0.8 0.03	63.0 2.48	64.0 2.52	0.8 0.03	92.0 3.62	89.0 3.50	1.1 0.04	2.0 0.08	42.0	15.7	0.0859	0.59 1.31
21.946 0.8640	15.875 0.6250	-3.0 -0.12	5.0 0.20	63.0 2.48	73.0 2.87	0.8 0.03	92.0 3.62	89.0 3.50	1.1 0.04	2.0 0.08	42.0	15.7	0.0859	0.59 1.29
24.608 0.9688	19.446 0.7656	-3.3 -0.13	3.5 0.14	63.0 2.48	70.0 2.76	0.8 0.03	92.0 3.62	88.0 3.46	1.5 0.06	1.8 0.08	54.0	22.6	0.0979	0.71 1.57
21.946 0.8640	20.274 0.7982	-3.0 -0.12	3.5 0.14	63.0 2.48	70.0 2.76	2.3 0.09	91.0 3.58	87.0 3.43	1.1 0.04	2.0 0.08	42.0	15.7	0.0859	0.66 1.45
24.608 0.9688	19.446 0.7656	-3.3 -0.13	3.5 0.14	63.0 2.48	70.0 2.76	0.8 0.03	92.0 3.62	88.0 3.46	1.5 0.06	1.8 0.08	54.0	22.6	0.0979	0.73 1.61
21.946 0.8640	17.826 0.7018	-3.0 -0.12	2.3 0.09	63.0 2.48	67.0 2.64	0.8 0.03	92.0 3.62	90.0 3.54	1.1 0.04	2.0 0.08	42.0	15.7	0.0859	0.64 1.41
21.946 0.8640	17.826 0.7018	-3.0 -0.12	3.5 0.14	63.0 2.48	70.0 2.76	0.8 0.03	92.0 3.62	90.0 3.54	1.1 0.04	2.0 0.08	42.0	15.7	0.0859	0.64 1.40
21.946 0.8640	17.826 0.7018	-3.0 -0.12	0.8 0.03	63.0 2.48	64.0 2.52	0.8 0.03	92.0 3.62	90.0 3.54	1.1 0.04	2.0 0.08	42.0	15.7	0.0859	0.64 1.41
21.946 0.8640	17.826 0.7018	-3.0 -0.12	5.0 0.20	63.0 2.48	73.0 2.87	0.8 0.03	92.0 3.62	90.0 3.54	1.1 0.04	2.0 0.08	42.0	15.7	0.0859	0.64 1.39
24.608 0.9688	19.446 0.7656	-3.3 -0.13	3.5 0.14	63.0 2.48	70.0 2.76	0.8 0.03	93.0 3.66	88.0 3.46	1.5 0.06	1.8 0.08	54.0	22.6	0.0979	0.75 1.65
21.946 0.8640	17.826 0.7018	-3.0 -0.12	3.5 0.14	63.0 2.48	70.0 2.76	2.0 0.08	93.0 3.66	89.0 3.50	1.1 0.04	2.0 0.08	42.0	15.7	0.0859	0.67 1.47
21.946 0.8640	22.225 0.8750	-3.0 -0.12	2.3 0.09	63.0 2.48	67.0 2.64	1.3 0.05	93.0 3.66	89.0 3.50	1.1 0.04	2.0 0.08	42.0	15.7	0.0859	0.76 1.67
29.317 1.1542	24.605 0.9687	-7.1 -0.28	2.3 0.09	63.0 2.48	67.0 2.64	3.3 0.13	98.0 3.86	92.0 3.62	2.1 0.08	1.4 0.06	58.6	17.1	0.0946	1.05 2.30
29.317 1.1542	24.605 0.9687	-7.1 -0.28	3.5 0.14	68.0 2.68	72.0 2.83	3.3 0.13	98.0 3.86	92.0 3.62	2.1 0.08	1.4 0.06	58.6	17.1	0.0946	1.05 2.30

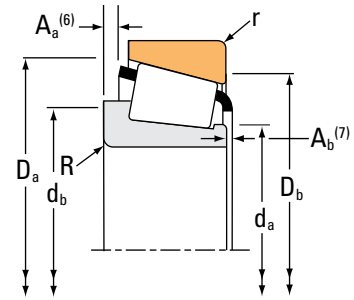
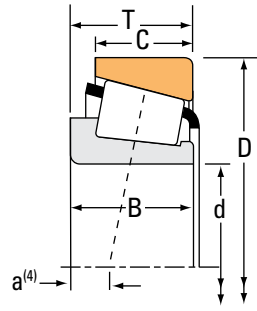
(4) Negative value indicates effective center inside cone (inner-ring) backface.
 (5) These maximum fillet radii will be cleared by the bearing corners.
 (6) Negative value indicates cage extends beyond cone (inner-ring) backface.
 (7) Negative value indicates cage that does not extend beyond cone (inner-ring) front face.

Continued on next page.

TAPERED ROLLER BEARINGS

SINGLE-ROW • TYPE TS

TYPE TS



Bearing Dimensions			Load Ratings							Part Number			
Bore d	O.D. D	Width T	Dynamic ⁽¹⁾		Factors ⁽²⁾		Dynamic ⁽³⁾		Factors ⁽²⁾		Static C ₀	Inner	Outer
			C ₁	e	Y	C ₉₀	C _{a90}	K	N	N			
mm in.	mm in.	mm in.	N lbf			N lbf	N lbf		N lbf				
57.150 2.2500	104.775 4.1250	30.162 1.1875	153000 34500	0.33	1.80	39700 8930	22600 5090	1.76	189000 42600			45290	45220
57.150 2.2500	104.775 4.1250	30.162 1.1875	161000 36100	0.34	1.79	41700 9370	23900 5380	1.74	166000 37200			462A	453X
57.150 2.2500	104.775 4.1250	30.162 1.1875	153000 34500	0.33	1.80	39700 8930	22600 5090	1.76	189000 42600			45289	45221
57.150 2.2500	104.775 4.1250	30.162 1.1875	153000 34500	0.33	1.80	39700 8930	22600 5090	1.76	189000 42600			45290	45221
57.150 2.2500	104.775 4.1250	30.162 1.1875	153000 34500	0.33	1.80	39700 8930	22600 5090	1.76	189000 42600			45291	45220
57.150 2.2500	104.775 4.1250	30.162 1.1875	153000 34500	0.33	1.80	39700 8930	22600 5090	1.76	189000 42600			45289	45220
57.150 2.2500	104.775 4.1250	30.162 1.1875	153000 34500	0.33	1.80	39700 8930	22600 5090	1.76	189000 42600			45291	45221
57.150 2.2500	107.950 4.2500	27.783 1.0938	161000 36100	0.34	1.79	41700 9370	23900 5380	1.74	166000 37200			462	453A
57.150 2.2500	107.950 4.2500	27.783 1.0938	161000 36100	0.34	1.79	41700 9370	23900 5380	1.74	166000 37200			469	453A
57.150 2.2500	107.950 4.2500	27.783 1.0938	161000 36100	0.34	1.79	41700 9370	23900 5380	1.74	166000 37200			462	453AS
57.150 2.2500	107.950 4.2500	32.558 1.2818	161000 36100	0.34	1.79	41700 9370	23900 5380	1.74	166000 37200			462	452A
57.150 2.2500	110.000 4.3307	22.000 0.8661	98900 22200	0.40	1.49	25600 5760	17600 3970	1.45	125000 28100			390	394A
57.150 2.2500	110.000 4.3307	22.000 0.8661	98900 22200	0.40	1.49	25600 5760	17600 3970	1.45	125000 28100			390	394AS
57.150 2.2500	110.000 4.3307	27.795 1.0943	161000 36100	0.34	1.79	41700 9370	23900 5380	1.74	166000 37200			462	454
57.150 2.2500	112.712 4.4375	25.400 1.0000	111000 24800	0.49	1.23	28600 6440	23900 5370	1.20	166000 37200			29665	29620
57.150 2.2500	112.712 4.4375	26.967 1.0617	98900 22200	0.40	1.49	25600 5760	17600 3970	1.45	125000 28100			390	3920
57.150 2.2500	112.712 4.4375	30.162 1.1875	139000 31200	0.40	1.49	36000 8090	24800 5570	1.45	191000 43000			3979	3920

⁽¹⁾Based on 1 x 10⁶ revolutions L₁₀ life, for the ISO life-calculation method.

⁽²⁾Consult your Timken engineer for instructions on use or review the Timken Engineering Manual on timken.com/catalogs.

⁽³⁾Based on 90 x 10⁶ revolutions L₁₀ life, for The Timken Company life-calculation method. C₉₀ and C_{a90} are radial and thrust values.

Bearing Dimensions											Geometry Factors			Bearing Weight
Width B	Width C	Eff. Ctr. a ⁽⁴⁾	Shaft			Housing			Cage		G ₁	G ₂	C _g	
			Max Shaft Fillet Radius R ⁽⁵⁾	Backing Shoulder Dia. d _a d _b		Max Housing Fillet Radius r ⁽⁵⁾	Backing Shoulder Dia. D _a D _b		A _a ⁽⁶⁾	A _b ⁽⁷⁾				
mm in.	mm in.	mm in.	mm in.	mm in.	mm in.	mm in.	mm in.	mm in.	mm in.	mm in.				kg lbs.
30.958 1.2188	23.812 0.9375	-8.1 -0.32	2.3 0.09	65.0 2.56	68.0 2.68	3.3 0.13	99.0 3.90	93.0 3.66	2.1 0.08	1.8 0.07	63.5	16.9	0.0971	1.09 2.39
29.317 1.1542	24.605 0.9687	-7.1 -0.28	2.3 0.09	68.0 2.68	67.0 2.64	3.3 0.13	98.0 3.86	92.0 3.62	2.1 0.08	1.4 0.06	58.6	17.1	0.0946	1.04 2.28
30.958 1.2188	23.812 0.9375	-8.1 -0.32	0.8 0.03	65.0 2.56	65.0 2.56	0.8 0.03	99.0 3.90	95.0 3.74	2.1 0.08	1.8 0.07	63.5	16.9	0.0971	1.09 2.40
30.958 1.2188	23.812 0.9375	-8.1 -0.32	2.3 0.09	65.0 2.56	68.0 2.68	0.8 0.03	99.0 3.90	95.0 3.74	2.1 0.08	1.8 0.07	63.5	16.9	0.0971	1.09 2.40
30.958 1.2188	23.812 0.9375	-8.1 -0.32	6.4 0.25	65.0 2.56	76.0 2.99	3.3 0.13	99.0 3.90	93.0 3.66	2.1 0.08	1.8 0.07	63.5	16.9	0.0971	1.06 2.32
30.958 1.2188	23.812 0.9375	-8.1 -0.32	0.8 0.03	65.0 2.56	65.0 2.56	3.3 0.13	99.0 3.90	93.0 3.66	2.1 0.08	1.8 0.07	63.5	16.9	0.0971	1.09 2.39
30.958 1.2188	23.812 0.9375	-8.1 -0.32	6.4 0.25	65.0 2.56	76.0 2.99	0.8 0.03	99.0 3.90	95.0 3.74	2.1 0.08	1.8 0.07	63.5	16.9	0.0971	1.06 2.33
29.317 1.1542	22.225 0.8750	-7.1 -0.28	2.3 0.09	63.0 2.48	67.0 2.64	0.8 0.03	100.0 3.94	97.0 3.82	2.1 0.08	1.4 0.06	58.6	17.1	0.0946	1.10 2.42
29.317 1.1542	22.225 0.8750	-7.1 -0.28	3.5 0.14	68.0 2.68	72.0 2.83	0.8 0.03	100.0 3.94	97.0 3.82	2.1 0.08	1.4 0.06	58.6	17.1	0.0946	1.10 2.42
29.317 1.1542	22.225 0.8750	-7.1 -0.28	2.3 0.09	63.0 2.48	67.0 2.64	2.3 0.09	100.0 3.94	95.0 3.74	2.1 0.08	1.4 0.06	58.6	17.1	0.0946	1.10 2.42
29.317 1.1542	27.000 1.0630	-7.1 -0.28	2.3 0.09	63.0 2.48	67.0 2.64	3.3 0.13	100.0 3.94	93.0 3.66	2.1 0.08	1.4 0.06	58.6	17.1	0.0946	1.21 2.66
21.996 0.8660	18.824 0.7411	-0.8 -0.03	2.3 0.09	66.0 2.60	70.0 2.76	1.3 0.05	105.0 4.13	101.0 3.98	1.6 0.06	2.3 0.09	56.0	21.4	0.0984	0.94 2.07
21.996 0.8660	18.824 0.7411	-0.8 -0.03	2.3 0.09	66.0 2.60	70.0 2.76	3.3 0.13	104.5 4.11	99.0 3.90	1.6 0.06	2.3 0.09	56.0	21.4	0.0984	0.93 2.04
29.317 1.1542	27.000 1.0630	-7.1 -0.28	2.3 0.09	63.0 2.48	67.0 2.64	2.0 0.08	100.0 3.94	96.0 3.78	2.1 0.08	1.4 0.06	58.6	17.1	0.0946	1.23 2.70
25.400 1.0000	19.050 0.7500	1.0 0.04	3.5 0.14	69.0 2.72	75.0 2.95	3.3 0.13	109.0 4.29	101.0 3.98	2.3 0.09	1.5 0.06	77.7	43.3	0.1170	1.20 2.65
21.996 0.8660	23.812 0.9375	-0.8 -0.03	2.3 0.09	66.0 2.60	70.0 2.76	3.3 0.13	106.0 4.17	99.0 3.90	1.6 0.06	2.3 0.09	56.0	21.4	0.0984	1.13 2.49
30.048 1.1830	23.812 0.9375	-4.6 -0.18	3.5 0.14	66.0 2.60	72.0 2.83	3.3 0.13	106.0 4.17	99.0 3.90	2.2 0.08	1.2 0.05	75.2	21.3	0.1092	1.37 3.04

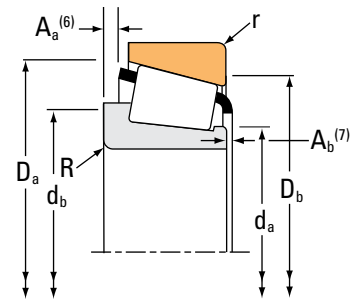
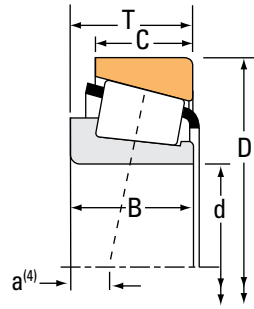
⁽⁴⁾Negative value indicates effective center inside cone (inner-ring) backface.
⁽⁵⁾These maximum fillet radii will be cleared by the bearing corners.
⁽⁶⁾Negative value indicates cage extends beyond cone (inner-ring) backface.
⁽⁷⁾Negative value indicates cage that does not extend beyond cone (inner-ring) front face.

Continued on next page.

TAPERED ROLLER BEARINGS

SINGLE-ROW • TYPE TS

TYPE TS



Bearing Dimensions			Load Ratings							Part Number		
Bore d	O.D. D	Width T	Dynamic ⁽¹⁾		Factors ⁽²⁾		Dynamic ⁽³⁾		Factors ⁽²⁾	Static	Inner	Outer
			C ₁	e	Y	C ₉₀	C _{a90}	K	C ₀			
mm in.	mm in.	mm in.	N lbf			N lbf	N lbf			N lbf		
57.150 2.2500	112.712 4.4375	30.162 1.1875	167000 37500	0.34	1.77	43300 9730	25100 5650	1.72		224000 50300	39580	39520
57.150 2.2500	112.712 4.4375	30.162 1.1875	167000 37500	0.34	1.77	43300 9730	25100 5650	1.72		224000 50300	39581	39520
57.150 2.2500	112.712 4.4375	30.162 1.1875	167000 37500	0.34	1.77	43300 9730	25100 5650	1.72		224000 50300	39580	39521
57.150 2.2500	117.475 4.6250	33.338 1.3125	177000 39700	0.63	0.96	45800 10300	49100 11000	0.93		166000 37300	66225	66462
57.150 2.2500	120.650 4.7500	41.275 1.6250	207000 46600	0.31	1.91	53800 12100	28900 6510	1.86		244000 54800	623	612
57.150 2.2500	120.650 4.7500	41.275 1.6250	207000 46600	0.31	1.91	53800 12100	28900 6510	1.86		244000 54800	623A	612
57.150 2.2500	120.650 4.7500	41.275 1.6250	207000 46600	0.31	1.91	53800 12100	28900 6510	1.86		244000 54800	623	612-S
57.150 2.2500	122.238 4.8125	33.338 1.3125	155000 34800	0.67	0.90	40100 9010	45600 10300	0.88		178000 39900	66587	66520
57.150 2.2500	123.825 4.8750	36.512 1.4375	214000 48200	0.74	0.81	55500 12500	70100 15800	0.79		208000 46800	72225C	72487
57.150 2.2500	123.825 4.8750	38.100 1.5000	226000 50800	0.35	1.73	58600 13200	34700 7810	1.69		248000 55700	555-S	552
57.150 2.2500	123.825 4.8750	38.100 1.5000	226000 50800	0.35	1.73	58600 13200	34700 7810	1.69		248000 55700	555-S	552A
57.150 2.2500	125.000 4.9213	38.100 1.5000	226000 50800	0.35	1.73	58600 13200	34700 7810	1.69		248000 55700	555-S	553A
57.150 2.2500	127.000 5.0000	44.450 1.7500	243000 54700	0.49	1.23	63100 14200	52700 11800	1.20		297000 66700	65225	65500
57.150 2.2500	129.944 5.1159	38.100 1.5000	226000 50800	0.35	1.73	58600 13200	34700 7810	1.69		248000 55700	555-S	553-SA
57.150 2.2500	135.755 5.3447	53.975 2.1250	321000 72300	0.32	1.85	83300 18700	46300 10400	1.80		404000 90900	6375	6320
57.150 2.2500	135.755 5.3447	53.975 2.1250	321000 72300	0.32	1.85	83300 18700	46300 10400	1.80		404000 90900	6387	6320
57.150 2.2500	136.525 5.3750	36.512 1.4375	237000 53200	0.87	0.69	61300 13800	90900 20400	0.67		234000 52600	78225C	78537

⁽¹⁾Based on 1 x 10⁶ revolutions L₁₀ life, for the ISO life-calculation method.

⁽²⁾Consult your Timken engineer for instructions on use or review the Timken Engineering Manual on timken.com/catalogs.

⁽³⁾Based on 90 x 10⁶ revolutions L₁₀ life, for The Timken Company life-calculation method. C₉₀ and C_{a90} are radial and thrust values.

Bearing Dimensions											Geometry Factors			Bearing Weight
Width B	Width C	Eff. Ctr. a ⁽⁴⁾	Shaft			Housing			Cage		G ₁	G ₂	C _g	
			Max Shaft Fillet Radius R ⁽⁵⁾	Backing Shoulder Dia. d _a	Backing Shoulder Dia. d _b	Max Housing Fillet Radius r ⁽⁵⁾	Backing Shoulder Dia. D _a	Backing Shoulder Dia. D _b	A _a ⁽⁶⁾	A _b ⁽⁷⁾				
mm in.	mm in.	mm in.	mm in.	mm in.	mm in.	mm in.	mm in.	mm in.	mm in.	mm in.				kg lbs.
30.162 1.1875	23.812 0.9375	-6.6 -0.26	3.5 0.14	68.0 2.68	74.0 2.91	3.3 0.13	107.0 4.21	101.0 3.98	1.6 0.06	2.7 0.11	84.3	23.7	0.1074	1.38 3.04
30.162 1.1875	23.812 0.9375	-6.6 -0.26	8.0 0.31	66.0 2.60	81.0 3.19	3.3 0.13	107.0 4.21	101.0 3.98	1.6 0.06	2.7 0.11	84.3	23.7	0.1074	1.37 3.01
30.162 1.1875	23.812 0.9375	-6.6 -0.26	3.5 0.14	68.0 2.68	74.0 2.91	0.8 0.03	107.0 4.21	103.0 4.06	1.6 0.06	2.7 0.11	84.3	23.7	0.1074	1.38 3.06
31.750 1.2500	23.812 0.9375	-0.3 -0.01	3.5 0.14	68.9 2.71	76.0 2.99	3.3 0.13	111.0 4.37	100.0 3.94	5.0 0.19	2.0 0.08	50.2	16.4	0.0751	1.50 3.31
41.275 1.6250	31.750 1.2500	-14.0 -0.55	3.5 0.14	66.0 2.60	72.0 2.83	3.3 0.13	110.0 4.33	105.0 4.13	3.8 0.15	1.9 0.08	75.9	16.2	0.0694	2.09 4.62
41.275 1.6250	31.750 1.2500	-14.0 -0.55	6.4 0.25	66.0 2.60	78.0 3.07	3.3 0.13	110.0 4.33	105.0 4.13	3.8 0.15	1.9 0.08	75.9	16.2	0.0694	2.07 4.57
41.275 1.6250	31.750 1.2500	-14.0 -0.55	3.5 0.14	66.0 2.60	72.0 2.83	0.8 0.03	110.0 4.33	107.0 4.21	3.8 0.15	1.9 0.08	75.9	16.2	0.0694	2.10 4.65
31.750 1.2500	23.812 0.9375	2.0 0.08	3.5 0.14	71.0 2.80	77.0 3.03	3.3 0.13	116.0 4.57	105.0 4.13	5.2 0.20	2.0 0.08	57.0	18.3	0.0797	1.69 3.74
32.791 1.2910	25.400 1.0000	2.0 0.08	3.5 0.14	67.0 2.64	81.0 3.19	3.3 0.13	116.0 4.57	102.0 4.02	4.7 0.18	4.4 0.18	57.4	15.9	0.0825	1.98 4.37
36.678 1.4440	33.338 1.3125	-9.4 -0.37	3.5 0.14	70.0 2.76	76.0 2.99	3.3 0.13	116.0 4.57	109.0 4.29	2.3 0.09	1.3 0.05	91.0	21.1	0.1108	2.21 4.85
36.678 1.4440	30.162 1.1875	-9.4 -0.37	3.5 0.14	70.0 2.76	76.0 2.99	3.3 0.13	116.0 4.57	109.0 4.29	2.3 0.09	1.3 0.05	91.0	21.1	0.1108	2.16 4.75
36.678 1.4440	30.162 1.1875	-9.4 -0.37	3.5 0.14	70.0 2.76	76.0 2.99	3.3 0.13	116.0 4.57	109.0 4.29	2.3 0.09	1.3 0.05	91.0	21.1	0.1108	2.21 4.87
44.450 1.7500	34.925 1.3750	-9.4 -0.37	3.5 0.14	71.0 2.79	80.0 3.15	3.3 0.13	119.0 4.69	107.0 4.21	4.1 0.16	1.1 0.05	83.2	17.2	0.0827	2.71 5.97
36.678 1.4440	30.162 1.1875	-9.4 -0.37	3.5 0.14	70.0 2.76	76.0 2.99	3.3 0.13	116.0 4.57	111.0 4.37	2.3 0.09	1.3 0.05	91.0	21.1	0.1108	2.45 5.38
56.007 2.2050	44.450 1.7500	-19.3 -0.76	4.3 0.17	72.0 2.83	80.0 3.15	3.3 0.13	126.0 4.96	117.0 4.61	4.0 0.15	0.5 0.02	123.5	22.4	0.0827	3.96 8.74
56.007 2.2050	44.450 1.7500	-19.3 -0.76	0.8 0.03	72.0 2.83	72.0 2.83	3.3 0.13	126.0 4.96	117.0 4.61	4.0 0.15	0.5 0.02	123.5	22.4	0.0827	3.97 8.77
33.236 1.3085	23.520 0.9260	8.4 0.33	3.5 0.14	77.5 3.05	86.0 3.39	3.3 0.13	130.0 5.12	115.0 4.53	6.3 0.25	4.9 0.20	71.3	17.6	0.0926	2.52 5.56

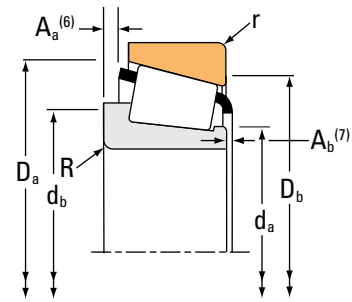
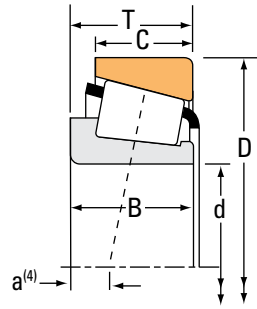
(4) Negative value indicates effective center inside cone (inner-ring) backface.
 (5) These maximum fillet radii will be cleared by the bearing corners.
 (6) Negative value indicates cage extends beyond cone (inner-ring) backface.
 (7) Negative value indicates cage that does not extend beyond cone (inner-ring) front face.

Continued on next page.

TAPERED ROLLER BEARINGS

SINGLE-ROW • TYPE TS

TYPE TS



Bearing Dimensions			Load Ratings							Part Number			
Bore d	O.D. D	Width T	Dynamic ⁽¹⁾		Factors ⁽²⁾		Dynamic ⁽³⁾		Factors ⁽²⁾		Static C ₀	Inner	Outer
			C ₁	e	Y	C ₉₀	C _{a90}	K	N	N			
mm in.	mm in.	mm in.	N lbf			N lbf	N lbf		N lbf				
57.150 2.2500	136.525 5.3750	41.275 1.6250	233000 52400	0.36	1.66	60400 13600	37400 8420	1.61	298000 67000		635	632	
57.150 2.2500	140.030 5.5130	36.512 1.4375	203000 45600	0.87	0.69	52600 11800	77900 17500	0.67	193000 43400		78225	78551	
57.150 2.2500	140.030 5.5130	36.512 1.4375	237000 53200	0.87	0.69	61300 13800	90900 20400	0.67	234000 52600		78225C	78551	
57.150 2.2500	149.225 5.8750	53.975 2.1250	411000 92400	0.36	1.66	107000 24000	66000 14800	1.61	463000 104000		6455	6420	
57.150 2.2500	149.225 5.8750	53.975 2.1250	411000 92400	0.36	1.66	107000 24000	66000 14800	1.61	463000 104000		6465	6420	
57.150 2.2500	149.225 5.8750	53.975 2.1250	411000 92400	0.36	1.66	107000 24000	66000 14800	1.61	463000 104000		6465	6420A	
57.150 2.2500	152.400 6.0000	53.975 2.1250	339000 76100	0.49	1.23	87800 19700	73200 16500	1.20	423000 95000		HH814540	HH814510	
57.531 2.2650	96.838 3.8125	21.000 0.8268	108000 24200	0.35	1.69	28000 6280	16900 3810	1.65	107000 24100		388A	382A	
57.531 2.2650	98.425 3.8750	21.000 0.8268	108000 24200	0.35	1.69	28000 6280	16900 3810	1.65	107000 24100		388A	382	
57.531 2.2650	100.000 3.9370	21.000 0.8268	108000 24200	0.35	1.69	28000 6280	16900 3810	1.65	107000 24100		388A	383A	
58.737 2.3125	112.712 4.4375	30.162 1.1875	139000 31200	0.40	1.49	36000 8090	24800 5570	1.45	191000 43000		3981	3920	
58.737 2.3125	127.000 5.0000	44.450 1.7500	243000 54700	0.49	1.23	63100 14200	52700 11800	1.20	297000 66700		65231	65500	
59.530 2.3437	112.712 4.4375	30.162 1.1875	139000 31200	0.40	1.49	36000 8090	24800 5570	1.45	191000 43000		3978	3920	
59.880 2.3575	127.000 5.0000	44.450 1.7500	243000 54700	0.49	1.23	63100 14200	52700 11800	1.20	297000 66700		65235	65500	
59.931 2.3595	150.089 5.9090	44.450 1.7500	318000 71400	0.33	1.84	82400 18500	45900 10300	1.80	417000 93800		745	742	
59.977 2.3613	100.000 3.9370	25.400 1.0000	106000 23800	0.43	1.41	27500 6180	20000 4500	1.37	149000 33500		28980	28921	
59.977 2.3613	122.238 4.8125	33.338 1.3125	155000 34800	0.67	0.90	40100 9010	45600 10300	0.88	178000 39900		66586	66520	

⁽¹⁾Based on 1 x 10⁶ revolutions L₁₀ life, for the ISO life-calculation method.

⁽²⁾Consult your Timken engineer for instructions on use or review the Timken Engineering Manual on timken.com/catalogs.

⁽³⁾Based on 90 x 10⁶ revolutions L₁₀ life, for The Timken Company life-calculation method. C₉₀ and C_{a90} are radial and thrust values.

Bearing Dimensions											Geometry Factors			Bearing Weight
Width B	Width C	Eff. Ctr. a ⁽⁴⁾	Shaft			Housing			Cage		G ₁	G ₂	C _g	
			Max Shaft Fillet Radius R ⁽⁵⁾	Backing Shoulder Dia. d _a d _b		Max Housing Fillet Radius r ⁽⁵⁾	Backing Shoulder Dia. D _a D _b		A _a ⁽⁶⁾	A _b ⁽⁷⁾				
mm in.	mm in.	mm in.	mm in.	mm in.	mm in.	mm in.	mm in.	mm in.	mm in.	mm in.			kg lbs.	
41.275 1.6250	31.750 1.2500	-11.2 -0.44	3.5 0.14	69.0 2.72	75.0 2.95	3.3 0.13	125.0 4.92	118.0 4.65	4.1 0.16	2.0 0.08	106.4	21.0	0.0814	3.02 6.66
33.236 1.3085	23.520 0.9260	7.9 0.31	3.5 0.14	77.0 3.03	83.0 3.27	2.3 0.09	132.0 5.20	117.0 4.61	6.9 0.27	4.2 0.17	62.6	19.1	0.0884	2.57 5.67
33.236 1.3085	23.520 0.9260	8.4 0.33	3.5 0.14	77.5 3.05	86.0 3.39	2.3 0.09	132.0 5.20	117.0 4.61	6.3 0.25	4.9 0.20	71.3	17.6	0.0926	2.66 5.88
54.229 2.1350	44.450 1.7500	-15.0 -0.59	3.5 0.14	75.0 2.95	81.0 3.19	3.3 0.13	140.0 5.51	129.0 5.08	2.7 0.10	0.7 0.03	158.3	29.1	0.0931	5.09 11.23
54.229 2.1350	44.450 1.7500	-15.0 -0.59	6.8 0.27	75.0 2.95	88.0 3.46	3.3 0.13	140.0 5.51	129.0 5.08	2.7 0.10	0.7 0.03	158.3	29.1	0.0931	5.07 11.18
54.229 2.1350	44.450 1.7500	-15.0 -0.59	6.8 0.27	75.0 2.95	88.0 3.46	0.8 0.03	140.0 5.51	131.0 5.16	2.7 0.10	0.7 0.03	158.3	29.1	0.0931	5.09 11.22
57.150 2.2500	41.275 1.6250	-12.2 -0.48	3.5 0.14	81.0 3.19	87.0 3.43	3.3 0.13	143.0 5.63	130.0 5.12	5.2 0.20	0.2 0.01	129.7	23.6	0.0957	5.21 11.48
21.946 0.8640	15.875 0.6250	-3.0 -0.12	3.5 0.14	63.0 2.48	70.0 2.76	0.8 0.03	92.0 3.62	89.0 3.50	1.1 0.04	2.0 0.08	42.0	15.7	0.0859	0.58 1.29
21.946 0.8640	17.826 0.7018	-3.0 -0.12	3.5 0.14	63.0 2.48	70.0 2.76	0.8 0.03	92.0 3.62	90.0 3.54	1.1 0.04	2.0 0.08	42.0	15.7	0.0859	0.63 1.39
21.946 0.8640	17.826 0.7018	-3.0 -0.12	3.5 0.14	63.0 2.48	70.0 2.76	2.0 0.08	93.0 3.66	89.0 3.50	1.1 0.04	2.0 0.08	42.0	15.7	0.0859	0.66 1.46
30.048 1.1830	23.812 0.9375	-4.6 -0.18	3.5 0.14	67.0 2.64	73.0 2.87	3.3 0.13	106.0 4.17	99.0 3.90	2.2 0.08	1.2 0.05	75.2	21.3	0.1092	1.34 2.96
44.450 1.7500	34.925 1.3750	-9.4 -0.37	3.5 0.14	71.0 2.79	81.0 3.19	3.3 0.13	119.0 4.69	107.0 4.21	4.1 0.16	1.1 0.05	83.2	17.2	0.0827	2.66 5.86
30.048 1.1830	23.812 0.9375	-4.6 -0.18	1.5 0.06	68.0 2.68	70.0 2.76	3.3 0.13	106.0 4.17	99.0 3.90	2.2 0.08	1.2 0.05	75.2	21.3	0.1092	1.33 2.94
44.450 1.7500	34.925 1.3750	-9.4 -0.37	3.5 0.14	71.0 2.79	82.0 3.23	3.3 0.13	119.0 4.69	107.0 4.21	4.1 0.16	1.1 0.05	83.2	17.2	0.0827	2.63 5.78
46.672 1.8375	36.512 1.4375	-11.9 -0.47	3.5 0.14	75.0 2.95	81.0 3.19	3.3 0.13	142.0 5.59	134.0 5.28	1.8 0.07	1.3 0.05	159.6	26.3	0.0898	4.29 9.45
25.400 1.0000	19.845 0.7813	-2.5 -0.10	3.5 0.14	67.0 2.64	73.0 2.87	3.3 0.13	96.0 3.78	89.0 3.50	2.0 0.07	1.4 0.06	60.1	24.5	0.1032	0.75 1.67
31.750 1.2500	23.812 0.9375	2.0 0.08	1.5 0.06	73.0 2.87	75.0 2.95	3.3 0.13	116.0 4.57	105.0 4.13	5.2 0.20	2.0 0.08	57.0	18.3	0.0797	1.63 3.61

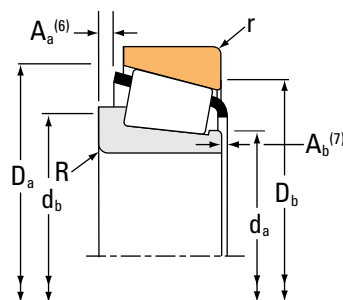
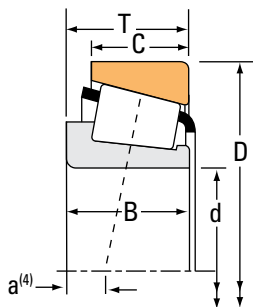
(4) Negative value indicates effective center inside cone (inner-ring) backface.
 (5) These maximum fillet radii will be cleared by the bearing corners.
 (6) Negative value indicates cage extends beyond cone (inner-ring) backface.
 (7) Negative value indicates cage that does not extend beyond cone (inner-ring) front face.

Continued on next page.

TAPERED ROLLER BEARINGS

SINGLE-ROW • TYPE TS

TYPE TS



Bearing Dimensions			Load Ratings							Part Number			
Bore d	O.D. D	Width T	Dynamic ⁽¹⁾		Factors ⁽²⁾		Dynamic ⁽³⁾		Factors ⁽²⁾		Static C ₀	Inner	Outer
			C ₁	e	Y	C ₉₀	C _{a90}	K	N	N			
mm in.	mm in.	mm in.	N lbf			N lbf	N lbf		N lbf				
59.987 2.3617	104.775 4.1250	21.433 0.8438	115000 25800	0.39	1.55	29700 6680	19700 4440	1.51	120000 27000		39236	39412	
59.987 2.3617	109.985 4.3301	29.751 1.1713	139000 31200	0.40	1.49	36000 8090	24800 5570	1.45	191000 43000		3977X	3921XA	
59.987 2.3617	110.058 4.3330	22.000 0.8661	115000 25800	0.39	1.55	29700 6680	19700 4440	1.51	120000 27000		39236	39433	
59.987 2.3617	112.712 4.4375	30.162 1.1875	139000 31200	0.40	1.49	36000 8090	24800 5570	1.45	191000 43000		3977X	3920	
59.987 2.3617	125.000 4.9213	38.100 1.5000	191000 42900	0.35	1.73	49400 11100	29300 6590	1.69	248000 55700		558-S	553A	
59.987 2.3617	127.000 5.0000	36.512 1.4375	229000 51500	0.50	1.20	59400 13400	51100 11500	1.16	256000 57600		HM813839	HM813810	
59.987 2.3617	129.944 5.1159	38.100 1.5000	191000 42900	0.35	1.73	49400 11100	29300 6590	1.69	248000 55700		558-S	553-SA	
59.987 2.3617	130.175 5.1250	34.100 1.3425	198000 44400	0.82	0.73	51200 11500	71900 16200	0.71	183000 41100		HM911244	HM911210	
59.987 2.3617	134.983 5.3143	33.450 1.3169	198000 44400	0.82	0.73	51200 11500	71900 16200	0.71	183000 41100		HM911244	HM911216	
59.987 2.3617	146.050 5.7500	41.275 1.6250	273000 61300	0.78	0.77	70700 15900	94700 21300	0.75	256000 57500		H913840	H913810	
60.000 2.3622	95.000 3.7402	24.000 0.9449	97600 21900	0.40	1.49	25300 5690	17400 3910	1.45	135000 30400		JLM508748	JLM508710	
60.000 2.3622	100.000 3.9370	21.000 0.8268	82500 18500	0.47	1.27	21400 4810	17300 3890	1.24	101000 22800		JP6049	JP6010	
60.000 2.3622	107.950 4.2500	25.400 1.0000	131000 29400	0.46	1.31	33800 7610	26600 5970	1.27	161000 36300		29580	29520	
60.000 2.3622	107.950 4.2500	25.400 1.0000	131000 29400	0.46	1.31	33800 7610	26600 5970	1.27	161000 36300		29582	29520	
60.000 2.3622	107.950 4.2500	25.400 1.0000	131000 29400	0.46	1.31	33800 7610	26600 5970	1.27	161000 36300		29582	29522	
60.000 2.3622	110.000 4.3307	22.000 0.8661	98900 22200	0.40	1.49	25600 5760	17600 3970	1.45	125000 28100		397	394AS	
60.000 2.3622	110.000 4.3307	22.000 0.8661	98900 22200	0.40	1.49	25600 5760	17600 3970	1.45	125000 28100		397	394A	

⁽¹⁾Based on 1 x 10⁶ revolutions L₁₀ life, for the ISO life-calculation method.

⁽²⁾Consult your Timken engineer for instructions on use or review the Timken Engineering Manual on timken.com/catalogs.

⁽³⁾Based on 90 x 10⁶ revolutions L₁₀ life, for The Timken Company life-calculation method. C₉₀ and C_{a90} are radial and thrust values.

Bearing Dimensions											Geometry Factors			Bearing Weight
Width B	Width C	Eff. Ctr. a ⁽⁴⁾	Shaft			Housing			Cage		G ₁	G ₂	C _g	
			Max Shaft Fillet Radius R ⁽⁵⁾	Backing Shoulder Dia. d _a	Backing Shoulder Dia. d _b	Max Housing Fillet Radius r ⁽⁵⁾	Backing Shoulder Dia. D _a	Backing Shoulder Dia. D _b	A _a ⁽⁶⁾	A _b ⁽⁷⁾				
mm in.	mm in.	mm in.	mm in.	mm in.	mm in.	mm in.	mm in.	mm in.	mm in.	mm in.				kg lbs.
22.000 0.8661	15.875 0.6250	-1.5 -0.06	2.3 0.09	67.0 2.64	71.0 2.80	2.0 0.08	100.0 3.94	96.0 3.78	1.6 0.06	2.4 0.10	51.7	19.5	0.0947	0.74 1.62
28.000 1.1024	23.812 0.9375	-4.6 -0.18	2.3 0.09	68.0 2.68	72.0 2.83	0.5 0.02	104.6 4.12	100.0 3.94	2.2 0.08	3.2 0.13	75.2	21.3	0.1092	1.20 2.65
22.000 0.8661	17.236 0.6786	-1.5 -0.06	2.3 0.09	67.0 2.64	71.0 2.80	2.3 0.09	103.0 4.06	98.0 3.86	1.6 0.06	2.4 0.10	51.7	19.5	0.0947	0.86 1.91
28.000 1.1024	23.812 0.9375	-4.6 -0.18	2.3 0.09	68.0 2.68	72.0 2.83	3.3 0.13	106.0 4.17	99.0 3.90	2.2 0.08	3.2 0.13	75.2	21.3	0.1092	1.29 2.85
36.678 1.4440	30.162 1.1875	-9.4 -0.37	3.5 0.14	69.0 2.72	75.0 2.95	3.3 0.13	116.0 4.57	109.0 4.29	2.3 0.09	1.3 0.05	91.0	21.1	0.1108	2.13 4.69
36.512 1.4375	26.988 1.0625	-3.8 -0.15	3.5 0.14	75.0 2.95	82.0 3.23	3.3 0.13	121.0 4.76	111.0 4.37	4.0 0.15	1.3 0.06	91.7	22.9	0.1252	2.18 4.82
36.678 1.4440	30.162 1.1875	-9.4 -0.37	3.5 0.14	69.0 2.72	75.0 2.95	3.3 0.13	116.0 4.57	111.0 4.37	2.3 0.09	1.3 0.05	91.0	21.1	0.1108	2.37 5.20
30.924 1.2175	23.812 0.9375	7.9 0.31	3.5 0.14	74.4 2.93	84.0 3.31	3.3 0.13	123.6 4.87	109.0 4.29	4.9 0.19	4.3 0.17	56.4	16.5	0.0842	1.99 4.40
30.924 1.2175	21.948 0.8641	7.9 0.31	3.5 0.14	74.4 2.93	84.0 3.31	3.5 0.14	123.0 4.84	112.0 4.41	4.9 0.19	4.3 0.17	56.4	16.5	0.0842	2.12 4.67
39.688 1.5625	25.400 1.0000	4.3 0.17	3.5 0.14	82.0 3.23	97.0 3.82	3.3 0.13	138.0 5.43	124.0 4.88	8.2 0.32	3.6 0.14	78.5	17.3	0.0927	3.19 7.02
24.000 0.9449	19.000 0.7480	-2.8 -0.11	5.0 0.20	66.0 2.60	75.0 2.95	2.5 0.10	91.0 3.58	85.0 3.35	1.4 0.05	1.6 0.07	54.2	27.5	0.0979	0.59 1.30
20.000 0.7874	15.500 0.6102	1.3 0.05	2.0 0.08	66.0 2.60	69.0 2.72	2.0 0.08	95.5 3.76	91.0 3.58	1.4 0.05	2.9 0.12	39.5	22.5	0.9220	0.59 1.31
25.400 1.0000	19.050 0.7500	-0.8 -0.03	3.5 0.14	68.0 2.68	75.0 2.95	3.3 0.13	103.0 4.06	96.0 3.78	2.1 0.08	1.4 0.06	70.3	25.9	0.1112	0.98 2.15
25.400 1.0000	19.050 0.7500	-0.8 -0.03	0.8 0.03	68.0 2.68	69.0 2.72	3.3 0.13	103.0 4.06	96.0 3.78	2.1 0.08	1.4 0.06	70.3	25.9	0.1112	0.99 2.18
25.400 1.0000	19.050 0.7500	-0.8 -0.03	0.8 0.03	68.0 2.68	69.0 2.72	0.8 0.03	103.0 4.06	98.0 3.86	2.1 0.08	1.4 0.06	70.3	25.9	0.1112	1.00 2.20
21.996 0.8660	18.824 0.7411	-0.8 -0.03	0.8 0.03	68.0 2.68	69.0 2.72	3.3 0.13	104.5 4.11	99.0 3.90	1.6 0.06	2.3 0.09	56.0	21.4	0.0984	0.89 1.95
21.996 0.8660	18.824 0.7411	-0.8 -0.03	0.8 0.03	68.0 2.68	69.0 2.72	1.3 0.05	105.0 4.13	101.0 3.98	1.6 0.06	2.3 0.09	56.0	21.4	0.0984	0.90 1.98

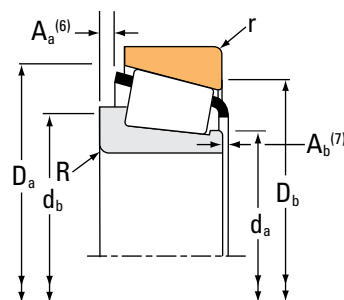
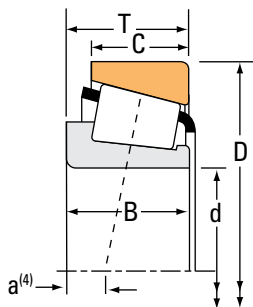
(4) Negative value indicates effective center inside cone (inner-ring) backface.
 (5) These maximum fillet radii will be cleared by the bearing corners.
 (6) Negative value indicates cage extends beyond cone (inner-ring) backface.
 (7) Negative value indicates cage that does not extend beyond cone (inner-ring) front face.

Continued on next page.

TAPERED ROLLER BEARINGS

SINGLE-ROW • TYPE TS

TYPE TS



Bearing Dimensions			Load Ratings							Part Number			
Bore d	O.D. D	Width T	Dynamic ⁽¹⁾		Factors ⁽²⁾		Dynamic ⁽³⁾		Factors ⁽²⁾		Static C ₀	Inner	Outer
			C ₁	e	Y	C ₉₀	C _{a90}	K	N	N			
mm in.	mm in.	mm in.	N lbf			N lbf	N lbf		N lbf				
60.000 2.3622	110.000 4.3307	25.400 1.0000	131000 29400	0.46	1.31	33800 7610	26600 5970	1.27	161000 36300		29580	29521	
60.000 2.3622	112.712 4.4375	30.162 1.1875	139000 31200	0.40	1.49	36000 8090	24800 5570	1.45	191000 43000		3977	3920	
60.000 2.3622	112.712 4.4375	30.162 1.1875	139000 31200	0.40	1.49	36000 8090	24800 5570	1.45	191000 43000		3977	3925	
60.000 2.3622	120.000 4.7244	29.794 1.1730	143000 32200	0.38	1.56	37200 8360	24500 5500	1.52	186000 41900		476	472	
60.000 2.3622	122.238 4.8125	33.338 1.3125	183000 41200	0.67	0.90	47500 10700	54100 12200	0.88	178000 39900		66585	66520	
60.000 2.3622	125.000 4.9213	37.000 1.4567	204000 45800	0.82	0.73	52800 11900	74100 16600	0.71	210000 47100		JW6049	JW6010	
60.325 2.3750	100.000 3.9370	25.400 1.0000	106000 23800	0.43	1.41	27500 6180	20000 4500	1.37	149000 33500		28985	28921A	
60.325 2.3750	100.000 3.9370	25.400 1.0000	106000 23800	0.43	1.41	27500 6180	20000 4500	1.37	149000 33500		28985	28921	
60.325 2.3750	101.600 4.0000	25.400 1.0000	106000 23800	0.43	1.41	27500 6180	20000 4500	1.37	149000 33500		28985	28920	
60.325 2.3750	112.712 4.4375	30.162 1.1875	139000 31200	0.40	1.49	36000 8090	24800 5570	1.45	191000 43000		3980	3920	
60.325 2.3750	112.712 4.4375	30.162 1.1875	139000 31200	0.40	1.49	36000 8090	24800 5570	1.45	191000 43000		3980	3925	
60.325 2.3750	122.238 4.8125	38.100 1.5000	267000 60000	0.34	1.78	69200 15600	40000 8990	1.73	279000 62700		HM212044	HM212011	
60.325 2.3750	122.238 4.8125	38.100 1.5000	267000 60000	0.34	1.78	69200 15600	40000 8990	1.73	279000 62700		HM212044	HM212010	
60.325 2.3750	122.238 4.8125	43.658 1.7188	280000 63000	0.36	1.67	72700 16300	44600 10000	1.63	327000 73500		5582	5535	
60.325 2.3750	122.238 4.8125	43.658 1.7188	280000 63000	0.36	1.67	72700 16300	44600 10000	1.63	327000 73500		5583	5535	
60.325 2.3750	123.825 4.8750	38.100 1.5000	226000 50800	0.35	1.73	58600 13200	34700 7810	1.69	248000 55700		558	552A	
60.325 2.3750	123.825 4.8750	38.100 1.5000	226000 50800	0.35	1.73	58600 13200	34700 7810	1.69	248000 55700		558	552	

⁽¹⁾Based on 1 x 10⁶ revolutions L₁₀ life, for the ISO life-calculation method.

⁽²⁾Consult your Timken engineer for instructions on use or review the Timken Engineering Manual on timken.com/catalogs.

⁽³⁾Based on 90 x 10⁶ revolutions L₁₀ life, for The Timken Company life-calculation method. C₉₀ and C_{a90} are radial and thrust values.

Bearing Dimensions											Geometry Factors			Bearing Weight
Width B	Width C	Eff. Ctr. a ⁽⁴⁾	Shaft			Housing			Cage		G ₁	G ₂	C _g	
			Max Shaft Fillet Radius R ⁽⁵⁾	Backing Shoulder Dia. d _a	Backing Shoulder Dia. d _b	Max Housing Fillet Radius r ⁽⁵⁾	Backing Shoulder Dia. D _a	Backing Shoulder Dia. D _b	A _a ⁽⁶⁾	A _b ⁽⁷⁾				
mm in.	mm in.	mm in.	mm in.	mm in.	mm in.	mm in.	mm in.	mm in.	mm in.	mm in.				kg lbs.
25.400 1.0000	19.050 0.7500	-0.8 -0.03	3.5 0.14	68.0 2.68	75.0 2.95	1.3 0.05	104.0 4.09	99.0 3.90	2.1 0.08	1.4 0.06	70.3	25.9	0.1112	1.05 2.30
30.048 1.1830	23.812 0.9375	-4.6 -0.18	3.5 0.14	68.0 2.68	74.0 2.91	3.3 0.13	106.0 4.17	99.0 3.90	2.2 0.08	1.2 0.05	75.2	21.3	0.1092	1.31 2.90
30.048 1.1830	23.812 0.9375	-4.6 -0.18	3.5 0.14	68.0 2.68	74.0 2.91	0.8 0.03	106.0 4.17	101.0 3.98	2.2 0.08	1.2 0.05	75.2	21.3	0.1092	1.32 2.91
29.007 1.1420	24.237 0.9542	-4.1 -0.16	2.0 0.08	69.0 2.72	73.0 2.87	2.0 0.08	114.0 4.49	107.0 4.21	1.5 0.05	2.2 0.09	77.2	23.0	0.1083	1.55 3.40
31.750 1.2500	23.812 0.9375	2.0 0.08	3.5 0.14	73.0 2.87	79.0 3.11	3.3 0.13	116.0 4.57	105.0 4.13	5.2 0.20	2.0 0.08	57.0	18.3	0.0797	1.62 3.59
33.500 1.3189	26.000 1.0236	4.8 0.19	3.0 0.12	72.0 2.83	89.0 3.50	3.0 0.12	119.0 4.69	104.0 4.09	5.9 0.23	4.1 0.16	64.1	18.6	0.0883	2.02 4.46
25.400 1.0000	19.845 0.7813	-2.5 -0.10	3.5 0.14	67.0 2.64	73.0 2.87	0.8 0.03	96.0 3.78	91.0 3.58	2.0 0.07	1.4 0.06	60.1	24.5	0.1032	0.76 1.68
25.400 1.0000	19.845 0.7813	-2.5 -0.10	3.5 0.14	67.0 2.64	73.0 2.87	3.3 0.13	96.0 3.78	89.0 3.50	2.0 0.07	1.4 0.06	60.1	24.5	0.1032	0.74 1.65
25.400 1.0000	19.845 0.7813	-2.5 -0.10	3.5 0.14	67.0 2.64	73.0 2.87	3.3 0.13	97.0 3.82	90.0 3.54	2.0 0.07	1.4 0.06	60.1	24.5	0.1032	0.78 1.74
30.048 1.1830	23.812 0.9375	-4.6 -0.18	3.5 0.14	68.0 2.68	75.0 2.95	3.3 0.13	106.0 4.17	99.0 3.90	2.2 0.08	1.2 0.05	75.2	21.3	0.1092	1.30 2.89
30.048 1.1830	23.812 0.9375	-4.6 -0.18	3.5 0.14	68.0 2.68	75.0 2.95	0.8 0.03	106.0 4.17	101.0 3.98	2.2 0.08	1.2 0.05	75.2	21.3	0.1092	1.31 2.90
38.354 1.5100	29.718 1.1700	-10.9 -0.43	8.0 0.31	70.0 2.76	85.0 3.35	3.3 0.13	116.0 4.57	108.0 4.25	2.2 0.08	3.1 0.12	92.2	18.1	0.0759	2.03 4.45
38.354 1.5100	29.718 1.1700	-10.9 -0.43	8.0 0.31	70.0 2.76	85.0 3.35	1.5 0.06	116.0 4.57	110.0 4.33	2.2 0.08	3.1 0.12	92.2	18.1	0.0759	2.03 4.46
43.764 1.7230	36.512 1.4375	-12.2 -0.48	0.8 0.03	72.0 2.83	73.0 2.87	3.3 0.13	116.0 4.57	106.0 4.17	2.5 0.09	1.3 0.05	110.4	24.2	0.0825	2.40 5.30
43.764 1.7230	36.512 1.4375	-12.2 -0.48	3.5 0.14	72.0 2.83	78.0 3.07	3.3 0.13	116.0 4.57	106.0 4.17	2.5 0.09	1.3 0.05	110.4	24.2	0.0825	2.39 5.28
36.678 1.4440	30.162 1.1875	-9.4 -0.37	2.3 0.09	72.0 2.83	76.0 2.99	3.3 0.13	116.0 4.57	109.0 4.29	2.3 0.09	1.3 0.05	91.0	21.1	0.1108	2.08 4.57
36.678 1.4440	33.338 1.3125	-9.4 -0.37	2.3 0.09	72.0 2.83	76.0 2.99	3.3 0.13	116.0 4.57	109.0 4.29	2.3 0.09	1.3 0.05	91.0	21.1	0.1108	2.13 4.67

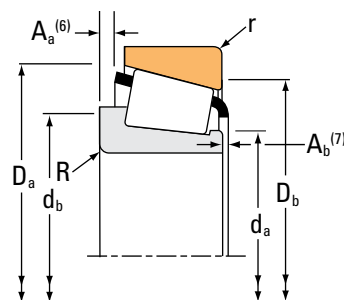
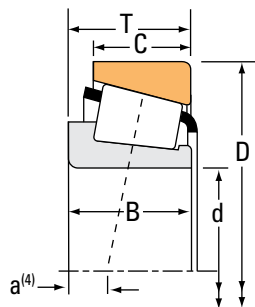
⁽⁴⁾Negative value indicates effective center inside cone (inner-ring) backface.
⁽⁵⁾These maximum fillet radii will be cleared by the bearing corners.
⁽⁶⁾Negative value indicates cage extends beyond cone (inner-ring) backface.
⁽⁷⁾Negative value indicates cage that does not extend beyond cone (inner-ring) front face.

Continued on next page.

TAPERED ROLLER BEARINGS

SINGLE-ROW • TYPE TS

TYPE TS



Bearing Dimensions			Load Ratings							Part Number		
Bore d	O.D. D	Width T	Dynamic ⁽¹⁾		Factors ⁽²⁾		Dynamic ⁽³⁾		Factors ⁽²⁾	Static	Inner	Outer
			C ₁	e	Y	C ₉₀	C _{a90}	K	C ₀			
mm in.	mm in.	mm in.	N lbf			N lbf	N lbf			N lbf		
60.325 2.3750	123.825 4.8750	38.100 1.5000	191000 42900	0.35	1.73	49400 11100	29300 6590	1.69		248000 55700	558A	552A
60.325 2.3750	127.000 5.0000	36.512 1.4375	229000 51500	0.50	1.20	59400 13400	51100 11500	1.16		256000 57600	HM813841	HM813811
60.325 2.3750	127.000 5.0000	36.512 1.4375	229000 51500	0.50	1.20	59400 13400	51100 11500	1.16		256000 57600	HM813841A	HM813811
60.325 2.3750	127.000 5.0000	36.512 1.4375	229000 51500	0.50	1.20	59400 13400	51100 11500	1.16		256000 57600	HM813841	HM813810
60.325 2.3750	127.000 5.0000	44.450 1.7500	243000 54700	0.49	1.23	63100 14200	52700 11800	1.20		297000 66700	65237	65500
60.325 2.3750	127.000 5.0000	44.450 1.7500	243000 54700	0.49	1.23	63100 14200	52700 11800	1.20		297000 66700	65237	65501
60.325 2.3750	127.000 5.0000	44.450 1.7500	243000 54700	0.49	1.23	63100 14200	52700 11800	1.20		297000 66700	65237A	65500
60.325 2.3750	130.175 5.1250	36.512 1.4375	198000 44400	0.82	0.73	51200 11500	71900 16200	0.71		183000 41100	HM911245	HM911210
60.325 2.3750	130.175 5.1250	41.275 1.6250	233000 52400	0.36	1.66	60400 13600	37400 8420	1.61		298000 67000	637	633
60.325 2.3750	135.755 5.3447	53.975 2.1250	321000 72300	0.32	1.85	83300 18700	46300 10400	1.80		404000 90900	6376	6320
60.325 2.3750	136.525 5.3750	36.512 1.4375	237000 53200	0.87	0.69	61300 13800	90900 20400	0.67		234000 52600	78238C	78537
60.325 2.3750	136.525 5.3750	41.275 1.6250	233000 52400	0.36	1.66	60400 13600	37400 8420	1.61		298000 67000	637	632
60.325 2.3750	136.525 5.3750	46.038 1.8125	319000 71700	0.47	1.27	82700 18600	67000 15100	1.24		405000 91000	H715332	H715311
60.325 2.3750	136.525 5.3750	46.038 1.8125	243000 54700	0.49	1.23	63100 14200	52700 11800	1.20		297000 66700	65237	65537
60.325 2.3750	139.700 5.5000	46.038 1.8125	319000 71700	0.47	1.27	82700 18600	67000 15100	1.24		405000 91000	H715332	H715310
60.325 2.3750	140.030 5.5130	36.512 1.4375	237000 53200	0.87	0.69	61300 13800	90900 20400	0.67		234000 52600	78238C	78551
60.325 2.3750	152.400 6.0000	52.705 2.0750	354000 79600	0.49	1.23	91800 20600	76600 17200	1.20		451000 101000	HH814542	HH814510

⁽¹⁾Based on 1 x 10⁶ revolutions L₁₀ life, for the ISO life-calculation method.

⁽²⁾Consult your Timken engineer for instructions on use or review the Timken Engineering Manual on timken.com/catalogs.

⁽³⁾Based on 90 x 10⁶ revolutions L₁₀ life, for The Timken Company life-calculation method. C₉₀ and C_{a90} are radial and thrust values.

Bearing Dimensions											Geometry Factors			Bearing Weight
Width B	Width C	Eff. Ctr. a ⁽⁴⁾	Shaft			Housing			Cage		G ₁	G ₂	C _g	
			Max Shaft Fillet Radius R ⁽⁵⁾	Backing Shoulder Dia. d _a	Shoulder Dia. d _b	Max Housing Fillet Radius r ⁽⁵⁾	Backing Shoulder Dia. D _a	Shoulder Dia. D _b	A _a ⁽⁶⁾	A _b ⁽⁷⁾				
mm in.	mm in.	mm in.	mm in.	mm in.	mm in.	mm in.	mm in.	mm in.	mm in.	mm in.				kg lbs.
36.678 1.4440	30.162 1.1875	-9.4 -0.37	3.5 0.14	69.0 2.72	76.0 2.99	3.3 0.13	116.0 4.57	109.0 4.29	2.3 0.09	1.3 0.05	91.0	21.1	0.1108	2.07 4.55
36.512 1.4375	26.988 1.0625	-3.8 -0.15	3.5 0.14	77.0 3.02	83.0 3.27	1.5 0.06	121.0 4.76	113.0 4.45	4.0 0.15	1.3 0.06	91.7	22.9	0.1252	2.17 4.80
36.512 1.4375	26.988 1.0625	-3.8 -0.15	1.5 0.06	76.0 2.99	78.0 3.07	1.5 0.06	121.0 4.76	113.0 4.45	4.0 0.15	1.3 0.06	91.7	22.9	0.1252	2.18 4.81
36.512 1.4375	26.988 1.0625	-3.8 -0.15	3.5 0.14	77.0 3.02	83.0 3.27	3.3 0.13	121.0 4.76	111.0 4.37	4.0 0.15	1.3 0.06	91.7	22.9	0.1252	2.17 4.80
44.450 1.7500	34.925 1.3750	-9.4 -0.37	3.5 0.14	71.0 2.80	87.0 3.43	3.3 0.13	119.0 4.69	107.0 4.21	4.1 0.16	1.1 0.05	83.2	17.2	0.0827	2.61 5.76
44.450 1.7500	34.925 1.3750	-9.4 -0.37	3.5 0.14	71.0 2.80	87.0 3.43	1.3 0.05	119.0 4.69	108.0 4.25	4.1 0.16	1.1 0.05	83.2	17.2	0.0827	2.61 5.76
44.450 1.7500	34.925 1.3750	-9.4 -0.37	1.5 0.06	71.1 2.80	78.0 3.07	3.3 0.13	119.0 4.69	107.0 4.21	4.1 0.16	1.1 0.05	83.2	17.2	0.0827	2.62 5.76
33.338 1.3125	23.812 0.9375	5.3 0.21	5.0 0.20	74.0 2.91	93.0 3.66	3.3 0.13	123.6 4.87	109.0 4.29	7.3 0.29	4.3 0.17	56.4	16.5	0.0842	2.06 4.55
41.275 1.6250	31.750 1.2500	-11.2 -0.44	3.5 0.14	72.0 2.83	78.0 3.07	3.3 0.13	124.0 4.88	116.0 4.57	4.1 0.16	2.0 0.08	106.4	21.0	0.0814	2.59 5.69
56.007 2.2050	44.450 1.7500	-19.3 -0.76	3.5 0.14	74.0 2.91	81.0 3.19	3.3 0.13	126.0 4.96	117.0 4.61	4.0 0.15	0.5 0.02	123.5	22.4	0.0827	3.83 8.46
33.236 1.3085	23.520 0.9260	8.4 0.33	5.0 0.20	77.5 3.05	91.0 3.58	3.3 0.13	130.0 5.12	115.0 4.53	6.3 0.25	4.9 0.20	71.3	17.6	0.0926	2.44 5.37
41.275 1.6250	31.750 1.2500	-11.2 -0.44	3.5 0.14	72.0 2.83	78.0 3.07	3.3 0.13	125.0 4.92	118.0 4.65	4.1 0.16	2.0 0.08	106.4	21.0	0.0814	2.93 6.45
46.038 1.8125	36.512 1.4375	-8.6 -0.34	3.5 0.14	80.0 3.15	86.0 3.39	3.3 0.13	132.0 5.20	118.0 4.65	4.1 0.16	2.0 0.08	147.1	33.5	0.0993	3.53 7.77
44.450 1.7500	36.512 1.4375	-9.4 -0.37	3.5 0.14	71.0 2.80	87.0 3.43	3.0 0.12	120.0 4.72	112.0 4.41	4.1 0.16	1.1 0.05	83.2	17.2	0.0827	3.23 7.12
46.038 1.8125	36.512 1.4375	-8.6 -0.34	3.5 0.14	80.0 3.15	86.0 3.39	3.3 0.13	133.0 5.24	120.0 4.72	4.1 0.16	2.0 0.08	147.1	33.5	0.0993	3.71 8.17
33.236 1.3085	23.520 0.9260	8.4 0.33	5.0 0.20	77.5 3.05	91.0 3.58	2.3 0.09	132.0 5.20	117.0 4.61	6.3 0.25	4.9 0.20	71.3	17.6	0.0926	2.58 5.69
52.705 2.0750	41.275 1.6250	-10.9 -0.43	3.5 0.14	83.0 3.27	89.0 3.50	3.3 0.13	143.0 5.63	130.0 5.12	4.0 0.16	2.5 0.10	135.7	24.6	0.0973	5.02 11.06

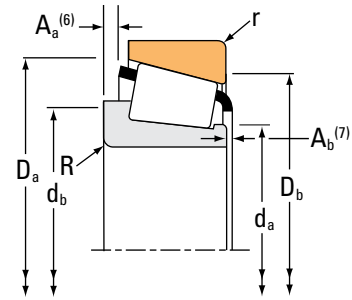
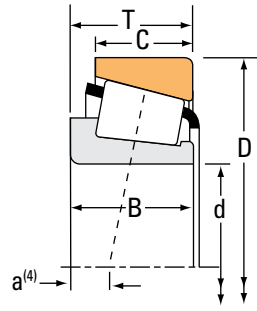
(4) Negative value indicates effective center inside cone (inner-ring) backface.
 (5) These maximum fillet radii will be cleared by the bearing corners.
 (6) Negative value indicates cage extends beyond cone (inner-ring) backface.
 (7) Negative value indicates cage that does not extend beyond cone (inner-ring) front face.

Continued on next page.

TAPERED ROLLER BEARINGS

SINGLE-ROW • TYPE TS

TYPE TS



Bearing Dimensions			Load Ratings							Part Number			
Bore d	O.D. D	Width T	Dynamic ⁽¹⁾		Factors ⁽²⁾		Dynamic ⁽³⁾		Factors ⁽²⁾		Static C ₀	Inner	Outer
			C ₁	e	Y	C ₉₀	C _{a90}	K	N	N			
mm in.	mm in.	mm in.	N lbf			N lbf	N lbf		N lbf				
61.912 2.4375	110.000 4.3307	22.000 0.8661	98900 22200	0.40	1.49	25600 5760	17600 3970	1.45	125000 28100		392	394A	
61.912 2.4375	112.712 4.4375	26.967 1.0617	98900 22200	0.40	1.49	25600 5760	17600 3970	1.45	125000 28100		392	3920	
61.912 2.4375	123.825 4.8750	38.100 1.5000	191000 42900	0.35	1.73	49400 11100	29300 6590	1.69	248000 55700		554	552A	
61.912 2.4375	127.000 5.0000	36.512 1.4375	229000 51500	0.50	1.20	59400 13400	51100 11500	1.16	256000 57600		HM813843	HM813810	
61.912 2.4375	130.175 5.1250	36.512 1.4375	198000 44400	0.82	0.73	51200 11500	71900 16200	0.71	183000 41100		HM911249	HM911210	
61.912 2.4375	136.525 5.3750	46.038 1.8125	319000 71700	0.47	1.27	82700 18600	67000 15100	1.24	405000 91000		H715334	H715311	
61.912 2.4375	139.700 5.5000	46.038 1.8125	319000 71700	0.47	1.27	82700 18600	67000 15100	1.24	405000 91000		H715334	H715310	
61.912 2.4375	146.050 5.7500	41.275 1.6250	273000 61300	0.78	0.77	70700 15900	94700 21300	0.75	256000 57500		H913842	H913810	
61.912 2.4375	146.050 5.7500	41.275 1.6250	273000 61300	0.78	0.77	70700 15900	94700 21300	0.75	256000 57500		H913843	H913810	
61.912 2.4375	152.400 6.0000	47.625 1.8750	285000 64200	0.66	0.91	74000 16600	83100 18700	0.89	306000 68700		9180	9121	
61.912 2.4375	152.400 6.0000	47.625 1.8750	285000 64200	0.66	0.91	74000 16600	83100 18700	0.89	306000 68700		9181	9121	
61.912 2.4375	158.750 6.2500	50.800 2.0000	285000 64200	0.66	0.91	74000 16600	83100 18700	0.89	306000 68700		9181	9120	
61.912 2.4375	158.750 6.2500	50.800 2.0000	285000 64200	0.66	0.91	74000 16600	83100 18700	0.89	306000 68700		9180	9120	
61.912 2.4375	158.750 6.2500	55.562 2.1875	285000 64200	0.66	0.91	74000 16600	83100 18700	0.89	306000 68700		9178	9120	
61.976 2.4400	99.979 3.9362	23.812 0.9375	106000 23800	0.43	1.41	27500 6180	20000 4500	1.37	149000 33500		28990	28919	
62.737 2.4700	100.000 3.9370	25.400 1.0000	106000 23800	0.43	1.41	27500 6180	20000 4500	1.37	149000 33500		28995	28921	
62.737 2.4700	101.600 4.0000	25.400 1.0000	106000 23800	0.43	1.41	27500 6180	20000 4500	1.37	149000 33500		28995	28920	

⁽¹⁾Based on 1 x 10⁶ revolutions L₁₀ life, for the ISO life-calculation method.

⁽²⁾Consult your Timken engineer for instructions on use or review the Timken Engineering Manual on timken.com/catalogs.

⁽³⁾Based on 90 x 10⁶ revolutions L₁₀ life, for The Timken Company life-calculation method. C₉₀ and C_{a90} are radial and thrust values.

Bearing Dimensions											Geometry Factors			Bearing Weight
Width B	Width C	Eff. Ctr. a ⁽⁴⁾	Shaft			Housing			Cage		G ₁	G ₂	C _g	
			Max Shaft Fillet Radius R ⁽⁵⁾	Backing Shoulder Dia. d _a	Shoulder Dia. d _b	Max Housing Fillet Radius r ⁽⁵⁾	Backing Shoulder Dia. D _a	Shoulder Dia. D _b	A _a ⁽⁶⁾	A _b ⁽⁷⁾				
mm in.	mm in.	mm in.	mm in.	mm in.	mm in.	mm in.	mm in.	mm in.	mm in.	mm in.			kg lbs.	
21.996 0.8660	18.824 0.7411	-0.8 -0.03	0.8 0.03	69.0 2.72	70.0 2.76	1.3 0.05	105.0 4.13	101.0 3.98	1.7 0.07	2.1 0.08	56.0	21.4	0.0984	0.86 1.91
21.996 0.8660	23.812 0.9375	-0.8 -0.03	0.8 0.03	69.0 2.72	70.0 2.76	3.3 0.13	106.0 4.17	99.0 3.90	1.7 0.07	2.1 0.08	56.0	21.4	0.0984	1.05 2.33
36.678 1.4440	30.162 1.1875	-9.4 -0.37	3.5 0.14	71.0 2.80	77.0 3.03	3.3 0.13	116.0 4.57	109.0 4.29	2.3 0.09	1.3 0.05	91.0	21.1	0.1108	2.02 4.46
36.512 1.4375	26.988 1.0625	-3.8 -0.15	3.5 0.14	78.0 3.07	85.0 3.35	3.3 0.13	121.0 4.76	111.0 4.37	4.0 0.15	1.3 0.06	91.7	22.9	0.1252	2.13 4.71
33.338 1.3125	23.812 0.9375	5.3 0.21	3.5 0.14	74.0 2.91	91.0 3.58	3.3 0.13	123.6 4.87	109.0 4.29	7.3 0.29	4.3 0.17	56.4	16.5	0.0842	2.03 4.48
46.038 1.8125	36.512 1.4375	-8.6 -0.34	3.5 0.14	81.0 3.19	87.0 3.43	3.3 0.13	132.0 5.20	118.0 4.65	4.1 0.16	2.0 0.08	147.1	33.5	0.0993	3.47 7.65
46.038 1.8125	36.512 1.4375	-8.6 -0.34	3.5 0.14	81.0 3.19	87.0 3.43	3.3 0.13	133.0 5.24	120.0 4.72	4.1 0.16	2.0 0.08	147.1	33.5	0.0993	3.65 8.05
39.688 1.5625	25.400 1.0000	4.3 0.17	3.5 0.14	82.4 3.24	90.0 3.54	3.3 0.13	138.0 5.43	124.0 4.88	8.2 0.32	3.6 0.14	78.5	17.3	0.0927	3.13 6.90
39.688 1.5625	25.400 1.0000	4.3 0.17	7.0 0.28	82.4 3.24	97.0 3.82	3.3 0.13	138.0 5.43	124.0 4.88	8.2 0.32	3.6 0.14	78.5	17.3	0.0927	3.11 6.87
46.038 1.8125	31.750 1.2500	-3.8 -0.15	3.5 0.14	81.3 3.20	90.0 3.54	3.3 0.13	145.0 5.71	130.0 5.12	8.1 0.31	4.1 0.16	87.6	13.7	0.0912	3.98 8.78
46.038 1.8125	31.750 1.2500	-3.8 -0.15	0.8 0.03	81.3 3.20	85.0 3.35	3.3 0.13	145.0 5.71	130.0 5.12	8.1 0.31	4.1 0.16	87.6	13.7	0.0912	3.99 8.80
46.038 1.8125	34.925 1.3750	-3.8 -0.15	0.8 0.03	81.3 3.20	85.0 3.35	3.3 0.13	146.0 5.75	131.0 5.16	8.1 0.31	4.1 0.16	87.6	13.7	0.0912	4.61 10.17
46.038 1.8125	34.925 1.3750	-3.8 -0.15	3.5 0.14	81.3 3.20	90.0 3.54	3.3 0.13	146.0 5.75	131.0 5.16	8.1 0.31	4.1 0.16	87.6	13.7	0.0912	4.60 10.14
52.388 2.0625	34.925 1.3750	-8.4 -0.33	3.5 0.14	81.3 3.20	90.0 3.54	3.3 0.13	146.0 5.75	131.0 5.16	12.8 0.50	2.5 0.10	87.6	13.7	0.0912	4.86 10.71
24.608 0.9688	19.050 0.7500	-1.8 -0.07	2.0 0.08	68.0 2.68	72.0 2.83	1.5 0.06	96.0 3.78	90.0 3.54	1.2 0.04	1.4 0.06	60.1	24.5	0.1032	0.70 1.56
25.400 1.0000	19.845 0.7813	-2.5 -0.10	3.5 0.14	69.0 2.72	75.0 2.95	3.3 0.13	96.0 3.78	89.0 3.50	2.0 0.07	1.4 0.06	60.1	24.5	0.1032	0.69 1.55
25.400 1.0000	19.845 0.7813	-2.5 -0.10	3.5 0.14	69.0 2.72	75.0 2.95	3.3 0.13	97.0 3.82	90.0 3.54	2.0 0.07	1.4 0.06	60.1	24.5	0.1032	0.73 1.64

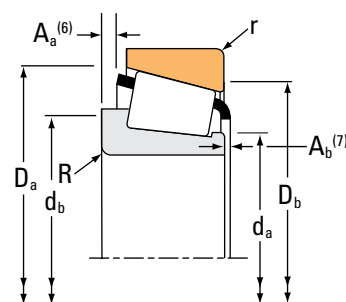
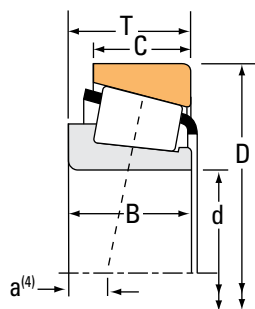
⁽⁴⁾Negative value indicates effective center inside cone (inner-ring) backface.
⁽⁵⁾These maximum fillet radii will be cleared by the bearing corners.
⁽⁶⁾Negative value indicates cage extends beyond cone (inner-ring) backface.
⁽⁷⁾Negative value indicates cage that does not extend beyond cone (inner-ring) front face.

Continued on next page.

TAPERED ROLLER BEARINGS

SINGLE-ROW • TYPE TS

TYPE TS



Bearing Dimensions			Load Ratings						Part Number			
Bore d	O.D. D	Width T	Dynamic ⁽¹⁾		Factors ⁽²⁾		Dynamic ⁽³⁾		Static		Inner	Outer
			C ₁	e	Y	C ₉₀	C _{a90}	K	C ₀			
mm in.	mm in.	mm in.	N lbf			N lbf	N lbf		N lbf			
63.500 2.5000	92.075 3.6250	13.495 0.5313	38700 8700	0.41	1.48	10000 2260	6960 1560	1.44	53300 12000		LL510749	LL510710
63.500 2.5000	94.458 3.7188	19.050 0.7500	67000 15100	0.42	1.41	17400 3910	12600 2840	1.38	108000 24300		L610549	L610510
63.500 2.5000	104.775 4.1250	21.433 0.8438	115000 25800	0.39	1.55	29700 6680	19700 4440	1.51	120000 27000		39250	39412
63.500 2.5000	107.158 4.2188	22.000 0.8661	115000 25800	0.39	1.55	29700 6680	19700 4440	1.51	120000 27000		39250	39422
63.500 2.5000	107.950 4.2500	25.400 1.0000	131000 29400	0.46	1.31	33800 7610	26600 5970	1.27	161000 36300		29585	29520
63.500 2.5000	107.950 4.2500	25.400 1.0000	131000 29400	0.46	1.31	33800 7610	26600 5970	1.27	161000 36300		29585	29522
63.500 2.5000	107.950 4.2500	25.400 1.0000	131000 29400	0.46	1.31	33800 7610	26600 5970	1.27	161000 36300		29586	29520
63.500 2.5000	107.950 4.2500	25.400 1.0000	131000 29400	0.46	1.31	33800 7610	26600 5970	1.27	161000 36300		29586	29522
63.500 2.5000	110.000 4.3307	22.000 0.8661	98900 22200	0.40	1.49	25600 5760	17600 3970	1.45	125000 28100		395	394
63.500 2.5000	110.000 4.3307	22.000 0.8661	98900 22200	0.40	1.49	25600 5760	17600 3970	1.45	125000 28100		395	394A
63.500 2.5000	110.000 4.3307	22.000 0.8661	98900 22200	0.40	1.49	25600 5760	17600 3970	1.45	125000 28100		395	394AS
63.500 2.5000	110.000 4.3307	22.000 0.8661	98900 22200	0.40	1.49	25600 5760	17600 3970	1.45	125000 28100		390A	394AS
63.500 2.5000	110.000 4.3307	22.000 0.8661	98900 22200	0.40	1.49	25600 5760	17600 3970	1.45	125000 28100		390A	394A
63.500 2.5000	110.000 4.3307	25.400 1.0000	131000 29400	0.46	1.31	33800 7610	26600 5970	1.27	161000 36300		29585	29521
63.500 2.5000	110.000 4.3307	25.400 1.0000	131000 29400	0.46	1.31	33800 7610	26600 5970	1.27	161000 36300		29586	29521
63.500 2.5000	110.000 4.3307	29.370 1.1563	139000 31200	0.40	1.49	36000 8090	24800 5570	1.45	191000 43000		3982X	3927AS
63.500 2.5000	110.000 4.3307	30.162 1.1875	139000 31200	0.40	1.49	36000 8090	24800 5570	1.45	191000 43000		3982	3927X

⁽¹⁾Based on 1×10^6 revolutions L_{10} life, for the ISO life-calculation method.

⁽²⁾Consult your Timken engineer for instructions on use or review the Timken Engineering Manual on timken.com/catalogs.

⁽³⁾Based on 90×10^6 revolutions L_{10} life, for The Timken Company life-calculation method. C_{90} and C_{a90} are radial and thrust values.

Bearing Dimensions											Geometry Factors			Bearing Weight
Width B	Width C	Eff. Ctr. a ⁽⁴⁾	Shaft			Housing			Cage		G ₁	G ₂	C _g	
			Max Shaft Fillet Radius R ⁽⁵⁾	Backing Shoulder Dia. d _a	Backing Shoulder Dia. d _b	Max Housing Fillet Radius r ⁽⁵⁾	Backing Shoulder Dia. D _a	Backing Shoulder Dia. D _b	A _a ⁽⁶⁾	A _b ⁽⁷⁾				
mm in.	mm in.	mm in.	mm in.	mm in.	mm in.	mm in.	mm in.	mm in.	mm in.	mm in.				kg lbs.
12.700 0.5000	9.525 0.3750	3.0 0.12	1.5 0.06	68.0 2.68	70.0 2.76	1.5 0.06	88.0 3.46	86.0 3.39	0.5 0.02	1.9 0.08	33.9	45.9	0.0827	0.26 0.58
19.050 0.7500	15.083 0.5938	0.5 0.02	1.5 0.06	69.0 2.72	71.0 2.80	1.5 0.06	91.0 3.58	86.0 3.39	0.9 0.03	1.5 0.06	56.7	50.3	0.1006	0.45 0.99
22.000 0.8661	15.875 0.6250	-1.5 -0.06	2.0 0.08	69.0 2.72	73.0 2.87	2.0 0.08	100.0 3.94	96.0 3.78	1.6 0.06	2.4 0.10	51.7	19.5	0.0947	0.68 1.50
22.000 0.8661	21.204 0.8348	-1.5 -0.06	2.0 0.08	69.0 2.72	73.0 2.87	2.3 0.09	102.0 4.02	97.0 3.82	1.6 0.06	2.4 0.10	51.7	19.5	0.0947	0.77 1.71
25.400 1.0000	19.050 0.7500	-0.8 -0.03	3.5 0.14	71.0 2.80	77.0 3.03	3.3 0.13	103.0 4.06	96.0 3.78	2.1 0.08	1.4 0.06	70.3	25.9	0.1112	0.91 2.01
25.400 1.0000	19.050 0.7500	-0.8 -0.03	3.5 0.14	71.0 2.80	77.0 3.03	0.8 0.03	103.0 4.06	98.0 3.86	2.1 0.08	1.4 0.06	70.3	25.9	0.1112	0.92 2.03
25.400 1.0000	19.050 0.7500	-0.8 -0.03	1.5 0.06	71.0 2.80	73.0 2.87	3.3 0.13	103.0 4.06	96.0 3.78	2.1 0.08	1.4 0.06	70.3	25.9	0.1112	0.92 2.02
25.400 1.0000	19.050 0.7500	-0.8 -0.03	1.5 0.06	71.0 2.80	73.0 2.87	0.8 0.03	103.0 4.06	98.0 3.86	2.1 0.08	1.4 0.06	70.3	25.9	0.1112	0.93 2.05
21.996 0.8660	22.000 0.8661	-0.8 -0.03	3.5 0.14	70.0 2.76	77.0 3.03	0.8 0.03	106.2 4.18	101.0 3.98	1.7 0.07	2.1 0.08	56.0	21.4	0.0984	0.85 1.88
21.996 0.8660	18.824 0.7411	-0.8 -0.03	3.5 0.14	70.0 2.76	77.0 3.03	1.3 0.05	105.0 4.13	101.0 3.98	1.7 0.07	2.1 0.08	56.0	21.4	0.0984	0.83 1.84
21.996 0.8660	18.824 0.7411	-0.8 -0.03	3.5 0.14	70.0 2.76	77.0 3.03	3.3 0.13	104.5 4.11	99.0 3.90	1.7 0.07	2.1 0.08	56.0	21.4	0.0984	0.82 1.81
21.996 0.8660	18.824 0.7411	-0.8 -0.03	1.5 0.06	70.0 2.76	73.0 2.87	3.3 0.13	104.5 4.11	99.0 3.90	1.6 0.06	2.3 0.09	56.0	21.4	0.0984	0.83 1.81
21.996 0.8660	18.824 0.7411	-0.8 -0.03	1.5 0.06	70.0 2.76	73.0 2.87	1.3 0.05	105.0 4.13	101.0 3.98	1.6 0.06	2.3 0.09	56.0	21.4	0.0984	0.84 1.84
25.400 1.0000	19.050 0.7500	-0.8 -0.03	3.5 0.14	71.0 2.80	77.0 3.03	1.3 0.05	104.0 4.09	99.0 3.90	2.1 0.08	1.4 0.06	70.3	25.9	0.1112	0.98 2.15
25.400 1.0000	19.050 0.7500	-0.8 -0.03	1.5 0.06	71.0 2.80	73.0 2.87	1.3 0.05	104.0 4.09	99.0 3.90	2.1 0.08	1.4 0.06	70.3	25.9	0.1112	0.99 2.17
30.048 1.1830	23.020 0.9063	-4.6 -0.18	7.0 0.28	71.0 2.80	84.0 3.31	0.5 0.02	105.0 4.13	101.0 3.94	2.2 0.08	1.2 0.05	75.2	21.3	0.1092	1.10 2.43
30.048 1.1830	23.812 0.9375	-4.6 -0.18	3.5 0.14	71.0 2.80	77.0 3.03	3.3 0.13	105.0 4.13	99.0 3.90	2.2 0.08	1.2 0.05	75.2	21.3	0.1092	1.13 2.50

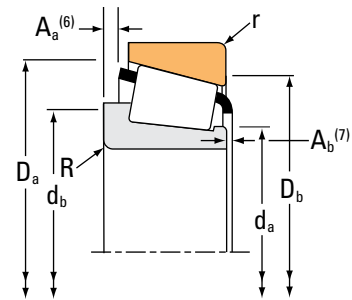
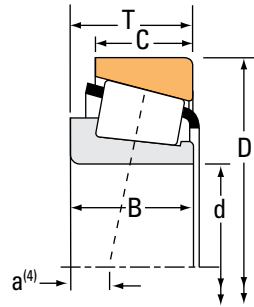
(4) Negative value indicates effective center inside cone (inner-ring) backface.
 (5) These maximum fillet radii will be cleared by the bearing corners.
 (6) Negative value indicates cage extends beyond cone (inner-ring) backface.
 (7) Negative value indicates cage that does not extend beyond cone (inner-ring) front face.

Continued on next page.

TAPERED ROLLER BEARINGS

SINGLE-ROW • TYPE TS

TYPE TS



Bearing Dimensions			Load Ratings							Part Number			
Bore d	O.D. D	Width T	Dynamic ⁽¹⁾		Factors ⁽²⁾		Dynamic ⁽³⁾		Factors ⁽²⁾		Static C ₀	Inner	Outer
			C ₁	e	Y	C ₉₀	C _{a90}	K	N	N			
mm in.	mm in.	mm in.	N lbf			N lbf	N lbf		N lbf				
63.500 2.5000	110.058 4.3330	22.000 0.8661	115000 25800	0.39	1.55	29700 6680	19700 4440	1.51	120000 27000		39250	39433	
63.500 2.5000	112.712 4.4375	26.967 1.0617	98900 22200	0.40	1.49	25600 5760	17600 3970	1.45	125000 28100		395	3920	
63.500 2.5000	112.712 4.4375	26.967 1.0617	98900 22200	0.40	1.49	25600 5760	17600 3970	1.45	125000 28100		390A	3920	
63.500 2.5000	112.712 4.4375	30.162 1.1875	139000 31200	0.40	1.49	36000 8090	24800 5570	1.45	191000 43000		3982	3925	
63.500 2.5000	112.712 4.4375	30.162 1.1875	139000 31200	0.40	1.49	36000 8090	24800 5570	1.45	191000 43000		3982	3920	
63.500 2.5000	112.712 4.4375	30.162 1.1875	167000 37500	0.34	1.77	43300 9730	25100 5650	1.72	224000 50300		39585	39520	
63.500 2.5000	112.712 4.4375	30.162 1.1875	167000 37500	0.34	1.77	43300 9730	25100 5650	1.72	224000 50300		39585A	39520	
63.500 2.5000	112.712 4.4375	33.338 1.3125	139000 31200	0.40	1.49	36000 8090	24800 5570	1.45	191000 43000		3982	3926	
63.500 2.5000	117.475 4.6250	30.162 1.1875	138000 31100	0.44	1.38	35900 8060	26800 6020	1.34	197000 44300		33251	33462	
63.500 2.5000	120.000 4.7244	29.002 1.1418	143000 32200	0.38	1.56	37200 8360	24500 5500	1.52	186000 41900		483	472A	
63.500 2.5000	120.000 4.7244	29.002 1.1418	143000 32200	0.38	1.56	37200 8360	24500 5500	1.52	186000 41900		477	472A	
63.500 2.5000	120.000 4.7244	29.794 1.1730	143000 32200	0.38	1.56	37200 8360	24500 5500	1.52	186000 41900		477	473	
63.500 2.5000	120.000 4.7244	29.794 1.1730	143000 32200	0.38	1.56	37200 8360	24500 5500	1.52	186000 41900		483	472	
63.500 2.5000	120.000 4.7244	29.794 1.1730	143000 32200	0.38	1.56	37200 8360	24500 5500	1.52	186000 41900		477	472	
63.500 2.5000	122.238 4.8125	38.100 1.5000	267000 60000	0.34	1.78	69200 15600	40000 8990	1.73	279000 62700		HM212046	HM212010	
63.500 2.5000	122.238 4.8125	38.100 1.5000	267000 60000	0.34	1.78	69200 15600	40000 8990	1.73	279000 62700		HM212047	HM212010	
63.500 2.5000	122.238 4.8125	38.100 1.5000	267000 60000	0.34	1.78	69200 15600	40000 8990	1.73	279000 62700		HM212047	HM212011	

⁽¹⁾Based on 1×10^6 revolutions L_{10} life, for the ISO life-calculation method.

⁽²⁾Consult your Timken engineer for instructions on use or review the Timken Engineering Manual on timken.com/catalogs.

⁽³⁾Based on 90×10^6 revolutions L_{10} life, for The Timken Company life-calculation method. C_{90} and C_{a90} are radial and thrust values.

Bearing Dimensions											Geometry Factors			Bearing Weight
Width B	Width C	Eff. Ctr. a ⁽⁴⁾	Shaft			Housing			Cage		G ₁	G ₂	C _g	
			Max Shaft Fillet Radius R ⁽⁵⁾	Backing Shoulder Dia. d _a	mm in.	Max Housing Fillet Radius r ⁽⁵⁾	Backing Shoulder Dia. D _a	mm in.	A _a ⁽⁶⁾	A _b ⁽⁷⁾				
mm in.	mm in.	mm in.	mm in.	mm in.	mm in.	mm in.	mm in.	mm in.	mm in.	mm in.			kg lbs.	
22.000 0.8661	17.236 0.6786	-1.5 -0.06	2.0 0.08	69.0 2.72	73.0 2.87	2.3 0.09	103.0 4.06	98.0 3.86	1.6 0.06	2.4 0.10	51.7	19.5	0.0947	0.80 1.78
21.996 0.8660	23.812 0.9375	-0.8 -0.03	3.5 0.14	70.0 2.76	77.0 3.03	3.3 0.13	106.0 4.17	99.0 3.90	1.7 0.07	2.1 0.08	56.0	21.4	0.0984	1.02 2.26
21.996 0.8660	23.812 0.9375	-0.8 -0.03	1.5 0.06	70.0 2.76	73.0 2.87	3.3 0.13	106.0 4.17	99.0 3.90	1.6 0.06	2.3 0.09	56.0	21.4	0.0984	1.03 2.26
30.048 1.1830	23.812 0.9375	-4.6 -0.18	3.5 0.14	71.0 2.80	77.0 3.03	0.8 0.03	106.0 4.17	101.0 3.98	2.2 0.08	1.2 0.05	75.2	21.3	0.1092	1.24 2.73
30.048 1.1830	23.812 0.9375	-4.6 -0.18	3.5 0.14	71.0 2.80	77.0 3.03	3.3 0.13	106.0 4.17	99.0 3.90	2.2 0.08	1.2 0.05	75.2	21.3	0.1092	1.23 2.72
30.162 1.1875	23.812 0.9375	-6.6 -0.26	3.5 0.14	71.0 2.80	77.0 3.03	3.3 0.13	107.0 4.21	101.0 3.98	1.6 0.06	2.7 0.11	84.3	23.7	0.1074	1.23 2.72
30.162 1.1875	23.812 0.9375	-6.6 -0.26	0.8 0.03	71.0 2.80	72.0 2.83	3.3 0.13	107.0 4.21	101.0 3.98	1.6 0.06	2.7 0.11	84.3	23.7	0.1074	1.24 2.74
30.048 1.1830	26.988 1.0625	-4.6 -0.18	3.5 0.14	71.0 2.80	77.0 3.03	3.3 0.13	106.0 4.17	98.0 3.86	2.2 0.08	1.2 0.05	75.2	21.3	0.1092	1.31 2.90
30.162 1.1875	23.812 0.9375	-2.8 -0.11	0.8 0.03	72.0 2.83	73.0 2.87	3.3 0.13	112.0 4.41	104.0 4.09	2.2 0.08	1.1 0.05	84.2	25.9	0.1162	1.42 3.13
29.007 1.1420	23.444 0.9230	-4.1 -0.16	3.5 0.14	72.0 2.83	78.0 3.07	3.3 0.13	114.0 4.49	106.0 4.17	1.5 0.05	2.2 0.09	77.2	23.0	0.1083	1.43 3.15
29.007 1.1420	23.444 0.9230	-4.1 -0.16	0.8 0.03	72.0 2.83	73.0 2.87	3.3 0.13	114.0 4.49	106.0 4.17	1.5 0.05	2.2 0.09	77.2	23.0	0.1083	1.44 3.17
29.007 1.1420	29.000 1.1417	-4.1 -0.16	0.8 0.03	72.0 2.83	73.0 2.87	2.0 0.08	114.0 4.49	107.0 4.21	1.5 0.05	2.2 0.09	77.2	23.0	0.1083	1.52 3.35
29.007 1.1420	24.237 0.9542	-4.1 -0.16	3.5 0.14	72.0 2.83	78.0 3.07	2.0 0.08	114.0 4.49	107.0 4.21	1.5 0.05	2.2 0.09	77.2	23.0	0.1083	1.46 3.22
29.007 1.1420	24.237 0.9542	-4.1 -0.16	0.8 0.03	72.0 2.83	73.0 2.87	2.0 0.08	114.0 4.49	107.0 4.21	1.5 0.05	2.2 0.09	77.2	23.0	0.1083	1.47 3.24
38.354 1.5100	29.718 1.1700	-10.9 -0.43	3.5 0.14	73.0 2.87	80.0 3.15	1.5 0.06	116.0 4.57	110.0 4.33	2.2 0.08	3.1 0.12	92.2	18.1	0.0759	1.95 4.30
38.354 1.5100	29.718 1.1700	-10.9 -0.43	7.0 0.28	73.0 2.87	87.0 3.43	1.5 0.06	116.0 4.57	110.0 4.33	2.2 0.08	3.1 0.12	92.2	18.1	0.0759	1.94 4.27
38.354 1.5100	29.718 1.1700	-10.9 -0.43	7.0 0.28	73.0 2.87	87.0 3.43	3.3 0.13	116.0 4.57	108.0 4.25	2.2 0.08	3.1 0.12	92.2	18.1	0.0759	1.94 4.25

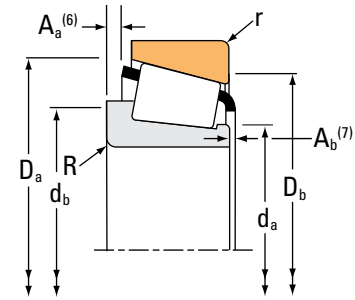
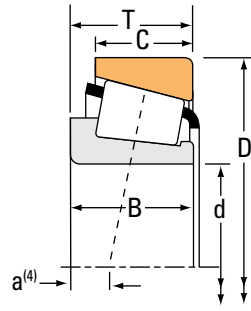
(4) Negative value indicates effective center inside cone (inner-ring) backface.
 (5) These maximum fillet radii will be cleared by the bearing corners.
 (6) Negative value indicates cage extends beyond cone (inner-ring) backface.
 (7) Negative value indicates cage that does not extend beyond cone (inner-ring) front face.

Continued on next page.

TAPERED ROLLER BEARINGS

SINGLE-ROW • TYPE TS

TYPE TS



Bearing Dimensions			Load Ratings							Part Number			
Bore d	O.D. D	Width T	Dynamic ⁽¹⁾		Factors ⁽²⁾		Dynamic ⁽³⁾		Factors ⁽²⁾		Static C ₀	Inner	Outer
			C ₁	e	Y	C ₉₀	C _{a90}	K	N	N			
mm in.	mm in.	mm in.	N lbf			N lbf	N lbf		N lbf				
63.500 2.5000	122.238 4.8125	38.100 1.5000	267000 60000	0.34	1.78	69200 15600	40000 8990	1.73	279000 62700			HM212046	HM212011
63.500 2.5000	122.238 4.8125	43.658 1.7188	237000 53200	0.36	1.67	61300 13800	37600 8460	1.63	327000 73500			5564	5535
63.500 2.5000	122.238 4.8125	43.658 1.7188	280000 63000	0.36	1.67	72700 16300	44600 10000	1.63	327000 73500			5584	5535
63.500 2.5000	123.825 4.8750	30.162 1.1875	143000 32200	0.38	1.56	37200 8360	24500 5500	1.52	186000 41900			483	472X
63.500 2.5000	123.825 4.8750	38.100 1.5000	226000 50800	0.35	1.73	58600 13200	34700 7810	1.69	248000 55700			559	552
63.500 2.5000	123.825 4.8750	38.100 1.5000	226000 50800	0.35	1.73	58600 13200	34700 7810	1.69	248000 55700			559	552A
63.500 2.5000	127.000 5.0000	36.512 1.4375	196000 44100	0.36	1.65	50900 11400	31700 7130	1.61	262000 58900			565	563
63.500 2.5000	127.000 5.0000	36.512 1.4375	229000 51500	0.50	1.20	59400 13400	51100 11500	1.16	256000 57600			HM813842	HM813811
63.500 2.5000	127.000 5.0000	36.512 1.4375	229000 51500	0.50	1.20	59400 13400	51100 11500	1.16	256000 57600			HM813842	HM813810
63.500 2.5000	127.000 5.0000	36.512 1.4375	229000 51500	0.50	1.20	59400 13400	51100 11500	1.16	256000 57600			HM813842A	HM813810
63.500 2.5000	130.000 5.1181	36.937 1.4542	196000 44100	0.36	1.65	50900 11400	31700 7130	1.61	262000 58900			565-S	562X
63.500 2.5000	130.000 5.1181	36.937 1.4542	196000 44100	0.36	1.65	50900 11400	31700 7130	1.61	262000 58900			565	562X
63.500 2.5000	130.000 5.1181	41.275 1.6250	276000 62100	0.36	1.66	71600 16100	44400 9980	1.61	298000 67000			639	633X
63.500 2.5000	130.175 5.1250	41.275 1.6250	276000 62100	0.36	1.66	71600 16100	44400 9980	1.61	298000 67000			639	633
63.500 2.5000	135.755 5.3447	53.975 2.1250	321000 72300	0.32	1.85	83300 18700	46300 10400	1.80	404000 90900			6382	6320
63.500 2.5000	136.525 5.3750	36.512 1.4375	203000 45600	0.87	0.69	52600 11800	77900 17500	0.67	193000 43400			78250	78537
63.500 2.5000	136.525 5.3750	36.512 1.4375	237000 53200	0.87	0.69	61300 13800	90900 20400	0.67	234000 52600			78248C	78537

⁽¹⁾Based on 1 x 10⁶ revolutions L₁₀ life, for the ISO life-calculation method.

⁽²⁾Consult your Timken engineer for instructions on use or review the Timken Engineering Manual on timken.com/catalogs.

⁽³⁾Based on 90 x 10⁶ revolutions L₁₀ life, for The Timken Company life-calculation method. C₉₀ and C_{a90} are radial and thrust values.

Bearing Dimensions											Geometry Factors			Bearing Weight
Width B	Width C	Eff. Ctr. a ⁽⁴⁾	Shaft			Housing			Cage		G ₁	G ₂	C _g	
			Max Shaft Fillet Radius R ⁽⁵⁾	Backing Shoulder Dia. d _a	Shoulder Dia. d _b	Max Housing Fillet Radius r ⁽⁵⁾	Backing Shoulder Dia. D _a	Shoulder Dia. D _b	A _a ⁽⁶⁾	A _b ⁽⁷⁾				
mm in.	mm in.	mm in.	mm in.	mm in.	mm in.	mm in.	mm in.	mm in.	mm in.	mm in.				kg lbs.
38.354 1.5100	29.718 1.1700	-10.9 -0.43	3.5 0.14	73.0 2.87	80.0 3.15	3.3 0.13	116.0 4.57	108.0 4.25	2.2 0.08	3.1 0.12	92.2	18.1	0.0759	1.95 4.28
43.764 1.7230	36.512 1.4375	-12.2 -0.48	5.0 0.20	75.0 2.95	84.0 3.31	3.3 0.13	116.0 4.57	106.0 4.17	2.5 0.09	1.3 0.05	110.4	24.2	0.0825	2.27 5.02
43.764 1.7230	36.512 1.4375	-12.2 -0.48	3.5 0.14	75.0 2.95	81.0 3.19	3.3 0.13	116.0 4.57	106.0 4.17	2.5 0.09	1.3 0.05	110.4	24.2	0.0825	2.28 5.04
29.007 1.1420	24.605 0.9687	-4.1 -0.16	3.5 0.14	72.0 2.83	78.0 3.07	3.3 0.13	115.0 4.53	109.0 4.29	1.5 0.05	2.2 0.09	77.2	23.0	0.1083	1.60 3.52
36.678 1.4440	33.338 1.3125	-9.4 -0.37	3.5 0.14	75.0 2.95	81.0 3.19	3.3 0.13	116.0 4.57	109.0 4.29	2.3 0.09	1.3 0.05	91.0	21.1	0.1108	2.03 4.47
36.678 1.4440	30.162 1.1875	-9.4 -0.37	3.5 0.14	75.0 2.95	81.0 3.19	3.3 0.13	116.0 4.57	109.0 4.29	2.3 0.09	1.3 0.05	91.0	21.1	0.1108	1.98 4.37
36.170 1.4240	28.575 1.1250	-8.1 -0.32	3.5 0.14	73.0 2.87	80.0 3.15	3.3 0.13	120.0 4.72	112.0 4.41	3.2 0.12	1.8 0.08	101.3	24.0	0.1167	2.09 4.62
36.512 1.4375	26.988 1.0625	-3.8 -0.15	3.5 0.14	78.0 3.07	84.0 3.31	1.5 0.06	121.0 4.76	113.0 4.45	4.0 0.15	1.3 0.06	91.7	22.9	0.1252	2.09 4.61
36.512 1.4375	26.988 1.0625	-3.8 -0.15	3.5 0.14	78.0 3.07	84.0 3.31	3.3 0.13	121.0 4.76	111.0 4.37	4.0 0.15	1.3 0.06	91.7	22.9	0.1252	2.09 4.61
36.512 1.4375	26.988 1.0625	-3.8 -0.15	0.8 0.03	78.0 3.07	78.0 3.07	3.3 0.13	121.0 4.76	111.0 4.37	4.0 0.15	1.3 0.06	91.7	22.9	0.1252	2.09 4.62
36.170 1.4240	29.000 1.1417	-8.1 -0.32	6.4 0.25	73.0 2.87	85.0 3.35	3.0 0.12	121.0 4.76	114.0 4.49	3.2 0.12	1.8 0.08	101.3	24.0	0.1167	2.21 4.88
36.170 1.4240	29.000 1.1417	-8.1 -0.32	3.5 0.14	73.0 2.87	80.0 3.15	3.0 0.12	121.0 4.76	114.0 4.49	3.2 0.12	1.8 0.08	101.3	24.0	0.1167	2.24 4.93
41.275 1.6250	31.750 1.2500	-11.2 -0.44	3.5 0.14	74.0 2.91	81.0 3.19	3.0 0.12	123.0 4.84	117.0 4.61	4.1 0.16	2.0 0.08	106.4	21.0	0.0814	2.48 5.46
41.275 1.6250	31.750 1.2500	-11.2 -0.44	3.5 0.14	74.0 2.91	81.0 3.19	3.3 0.13	124.0 4.88	116.0 4.57	4.1 0.16	2.0 0.08	106.4	21.0	0.0814	2.49 5.47
56.007 2.2050	44.450 1.7500	-19.3 -0.76	4.3 0.17	77.0 3.03	84.0 3.31	3.3 0.13	126.0 4.96	117.0 4.61	4.0 0.15	0.5 0.02	123.5	22.4	0.0827	3.69 8.15
33.236 1.3085	23.520 0.9260	7.9 0.31	2.3 0.09	79.0 3.10	85.0 3.35	3.3 0.13	130.0 5.12	115.0 4.53	6.9 0.27	4.2 0.17	62.6	19.1	0.0884	2.28 5.02
33.236 1.3085	23.520 0.9260	8.4 0.33	0.8 0.03	77.0 3.03	92.0 3.62	3.3 0.13	130.0 5.12	115.0 4.53	6.3 0.25	4.9 0.20	71.3	17.6	0.0926	2.38 5.24

⁽⁴⁾Negative value indicates effective center inside cone (inner-ring) backface.

⁽⁵⁾These maximum fillet radii will be cleared by the bearing corners.

⁽⁶⁾Negative value indicates cage extends beyond cone (inner-ring) backface.

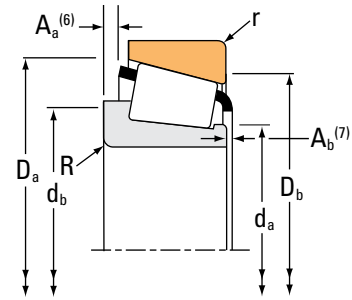
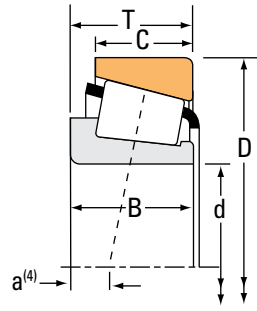
⁽⁷⁾Negative value indicates cage that does not extend beyond cone (inner-ring) front face.

Continued on next page.

TAPERED ROLLER BEARINGS

SINGLE-ROW • TYPE TS

TYPE TS



Bearing Dimensions			Load Ratings							Part Number			
Bore d	O.D. D	Width T	Dynamic ⁽¹⁾		Factors ⁽²⁾		Dynamic ⁽³⁾		Factors ⁽²⁾		Static C ₀	Inner	Outer
			C ₁	e	Y	C ₉₀	C _{a90}	K	N	N			
mm in.	mm in.	mm in.	N lbf			N lbf	N lbf		N lbf				
63.500 2.5000	136.525 5.3750	41.275 1.6250	276000 62100	0.36	1.66	71600 16100	44400 9980	1.61	298000 67000		639	632	
63.500 2.5000	136.525 5.3750	41.275 1.6250	323000 72600	0.36	1.67	83700 18800	51600 11600	1.62	335000 75400		H414235	H414210	
63.500 2.5000	136.525 5.3750	41.275 1.6250	272000 61200	0.36	1.67	70600 15900	43500 9790	1.62	335000 75400		H414236	H414210	
63.500 2.5000	136.525 5.3750	46.038 1.8125	319000 71700	0.47	1.27	82700 18600	67000 15100	1.24	405000 91000		H715336	H715311	
63.500 2.5000	139.700 5.5000	46.038 1.8125	319000 71700	0.47	1.27	82700 18600	67000 15100	1.24	405000 91000		H715336	H715310	
63.500 2.5000	140.030 5.5130	36.512 1.4375	203000 45600	0.87	0.69	52600 11800	77900 17500	0.67	193000 43400		78250	78551	
63.500 2.5000	149.225 5.8750	53.975 2.1250	411000 92400	0.36	1.66	107000 24000	66000 14800	1.61	463000 104000		6475	6420	
63.500 2.5000	150.089 5.9090	44.450 1.7500	377000 84700	0.33	1.84	97600 21900	54400 12200	1.80	417000 93800		745-S	742	
63.500 2.5000	177.800 7.0000	56.642 2.2300	451000 101000	0.80	0.75	117000 26300	160000 35900	0.73	413000 92900		HH914447	HH914412	
64.960 2.5575	149.225 5.8750	41.275 1.6250	247000 55500	0.41	1.47	64000 14400	44800 10100	1.43	335000 75300		656	652A	
64.960 2.5575	149.225 5.8750	53.975 2.1250	411000 92400	0.36	1.66	107000 24000	66000 14800	1.61	463000 104000		6464	6420	
64.963 2.5576	127.000 5.0000	36.512 1.4375	196000 44100	0.36	1.65	50900 11400	31700 7130	1.61	262000 58900		569	563	
64.987 2.5586	107.950 4.2500	25.400 1.0000	110000 24800	0.46	1.31	28600 6420	22400 5040	1.27	161000 36300		29588	29520	
64.987 2.5586	112.712 4.4375	30.162 1.1875	167000 37500	0.34	1.77	43300 9730	25100 5650	1.72	224000 50300		39586	39520	
64.987 2.5586	119.985 4.7238	32.750 1.2894	167000 37500	0.34	1.77	43300 9730	25100 5650	1.72	224000 50300		39586	39528	
64.987 2.5586	140.030 5.5130	36.512 1.4375	203000 45600	0.87	0.69	52600 11800	77900 17500	0.67	193000 43400		78255X	78551	
64.987 2.5586	144.983 5.7080	36.000 1.4173	203000 45600	0.87	0.69	52600 11800	77900 17500	0.67	193000 43400		78255X	78571	

⁽¹⁾Based on 1 x 10⁶ revolutions L₁₀ life, for the ISO life-calculation method.

⁽²⁾Consult your Timken engineer for instructions on use or review the Timken Engineering Manual on timken.com/catalogs.

⁽³⁾Based on 90 x 10⁶ revolutions L₁₀ life, for The Timken Company life-calculation method. C₉₀ and C_{a90} are radial and thrust values.

Bearing Dimensions											Geometry Factors			Bearing Weight
Width B	Width C	Eff. Ctr. a ⁽⁴⁾	Shaft			Housing			Cage		G ₁	G ₂	C _g	
			Max Shaft Fillet Radius R ⁽⁵⁾	Backing Shoulder Dia. d _a	Shoulder Dia. d _b	Max Housing Fillet Radius r ⁽⁵⁾	Backing Shoulder Dia. D _a	Shoulder Dia. D _b	A _a ⁽⁶⁾	A _b ⁽⁷⁾				
mm in.	mm in.	mm in.	mm in.	mm in.	mm in.	mm in.	mm in.	mm in.	mm in.	mm in.				kg lbs.
41.275 1.6250	31.750 1.2500	-11.2 -0.44	3.5 0.14	74.0 2.91	81.0 3.19	3.3 0.13	125.0 4.92	118.0 4.65	4.1 0.16	2.0 0.08	106.4	21.0	0.0814	2.83 6.23
41.275 1.6250	31.750 1.2500	-10.9 -0.43	3.5 0.14	78.0 3.07	82.0 3.23	3.3 0.13	129.0 5.08	121.0 4.76	3.7 0.14	3.1 0.12	112.8	22.9	0.0827	2.82 6.22
41.275 1.6250	31.750 1.2500	-10.9 -0.43	7.0 0.28	78.0 3.07	89.0 3.50	3.3 0.13	129.0 5.08	121.0 4.76	3.7 0.14	3.1 0.12	112.8	22.9	0.0827	2.78 6.15
46.038 1.8125	36.512 1.4375	-8.6 -0.34	3.5 0.14	82.0 3.23	88.0 3.46	3.3 0.13	132.0 5.20	118.0 4.65	4.1 0.16	2.0 0.08	147.1	33.5	0.0993	3.41 7.52
46.038 1.8125	36.512 1.4375	-8.6 -0.34	3.5 0.14	82.0 3.23	88.0 3.46	3.3 0.13	133.0 5.24	120.0 4.72	4.1 0.16	2.0 0.08	147.1	33.5	0.0993	3.59 7.93
33.236 1.3085	23.520 0.9260	7.9 0.31	2.3 0.09	79.0 3.10	85.0 3.35	2.3 0.09	132.0 5.20	117.0 4.61	6.9 0.27	4.2 0.17	62.6	19.1	0.0884	2.42 5.34
54.229 2.1350	44.450 1.7500	-15.0 -0.59	3.5 0.14	80.0 3.15	86.0 3.39	3.3 0.13	140.0 5.51	129.0 5.08	2.7 0.10	0.7 0.03	158.3	29.1	0.0931	4.84 10.67
46.672 1.8375	36.512 1.4375	-11.9 -0.47	3.5 0.14	77.0 3.03	84.0 3.31	3.3 0.13	142.0 5.59	134.0 5.28	1.8 0.07	1.3 0.05	159.6	26.3	0.0898	4.17 9.18
53.975 2.1250	37.308 1.4688	-0.3 -0.01	3.5 0.14	85.3 3.36	105.0 4.13	3.3 0.13	165.0 6.50	146.0 5.75	9.8 0.38	4.7 0.19	111.4	17.8	0.1044	6.79 14.97
41.275 1.6250	31.750 1.2500	-7.9 -0.31	3.5 0.14	78.0 3.07	85.0 3.35	3.3 0.13	141.0 5.55	132.0 5.20	4.5 0.17	2.1 0.08	136.6	27.3	0.0919	3.58 7.89
54.229 2.1350	44.450 1.7500	-15.0 -0.59	3.5 0.14	81.0 3.19	87.0 3.43	3.3 0.13	140.0 5.51	129.0 5.08	2.7 0.10	0.7 0.03	158.3	29.1	0.0931	4.77 10.53
36.170 1.4240	28.575 1.1250	-8.1 -0.32	3.5 0.14	74.0 2.91	81.0 3.19	3.3 0.13	120.0 4.72	112.0 4.41	3.2 0.12	1.8 0.08	101.3	24.0	0.1167	2.04 4.53
25.400 1.0000	19.050 0.7500	-0.8 -0.03	3.5 0.14	72.0 2.83	78.0 3.07	3.3 0.13	103.0 4.06	96.0 3.78	2.1 0.08	1.4 0.06	70.3	25.9	0.1112	0.88 1.94
30.924 1.2175	23.812 0.9375	-6.6 -0.26	2.3 0.09	72.0 2.83	76.0 2.99	3.3 0.13	107.0 4.21	101.0 3.98	1.6 0.06	1.9 0.08	84.3	23.7	0.1074	1.21 2.67
30.924 1.2175	26.950 1.0610	-6.6 -0.26	2.3 0.09	72.0 2.83	76.0 2.99	0.8 0.03	110.0 4.33	107.0 4.21	1.6 0.06	1.9 0.08	84.3	23.7	0.1074	1.55 3.43
32.923 1.2962	23.520 0.9260	7.9 0.31	3.5 0.14	79.0 3.11	89.0 3.50	2.3 0.09	132.0 5.20	117.0 4.61	6.9 0.27	4.5 0.18	62.6	19.1	0.0884	2.37 5.23
32.923 1.2962	23.007 0.9058	7.9 0.31	3.5 0.14	79.0 3.11	89.0 3.50	3.5 0.14	132.0 5.20	118.0 4.65	6.9 0.27	4.5 0.18	62.6	19.1	0.0884	2.52 5.56

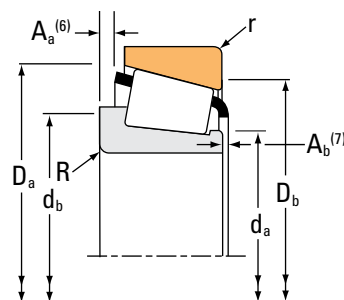
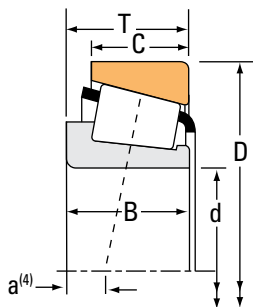
(4) Negative value indicates effective center inside cone (inner-ring) backface.
 (5) These maximum fillet radii will be cleared by the bearing corners.
 (6) Negative value indicates cage extends beyond cone (inner-ring) backface.
 (7) Negative value indicates cage that does not extend beyond cone (inner-ring) front face.

Continued on next page.

TAPERED ROLLER BEARINGS

SINGLE-ROW • TYPE TS

TYPE TS



Bearing Dimensions			Load Ratings							Part Number		
Bore d	O.D. D	Width T	Dynamic ⁽¹⁾		Factors ⁽²⁾		Dynamic ⁽³⁾		Factors ⁽²⁾	Static	Inner	Outer
			C ₁	e	Y	C ₉₀	C _{a90}	K	C ₀			
mm in.	mm in.	mm in.	N lbf			N lbf	N lbf			N lbf		
65.000 2.5591	105.000 4.1339	24.000 0.9449	128000 28800	0.45	1.32	33200 7470	25800 5810	1.29		139000 31300	JLM710949C	JLM710910
65.000 2.5591	110.000 4.3307	28.000 1.1024	167000 37600	0.40	1.49	43300 9740	29800 6700	1.45		195000 43900	JM511946	JM511910
65.000 2.5591	112.712 4.4375	22.225 0.8750	91600 20600	0.40	1.49	23700 5340	16300 3670	1.45		125000 28100	399	393A
65.000 2.5591	112.712 4.4375	29.020 1.1425	167000 37600	0.40	1.49	43300 9740	29800 6700	1.45		195000 43900	JM511946	3920
65.000 2.5591	112.712 4.4375	29.020 1.1425	167000 37600	0.40	1.49	43300 9740	29800 6700	1.45		195000 43900	JM511945	3920
65.000 2.5591	120.000 4.7244	29.002 1.1418	143000 32200	0.38	1.56	37200 8360	24500 5500	1.52		186000 41900	478	472A
65.000 2.5591	120.000 4.7244	29.794 1.1730	143000 32200	0.38	1.56	37200 8360	24500 5500	1.52		186000 41900	478	473
65.000 2.5591	120.000 4.7244	29.794 1.1730	143000 32200	0.38	1.56	37200 8360	24500 5500	1.52		186000 41900	478	472
65.000 2.5591	120.000 4.7244	39.000 1.5354	223000 50100	0.34	1.78	57800 13000	33400 7500	1.73		283000 63600	JH211749	JH211710
65.000 2.5591	120.000 4.7244	39.000 1.5354	223000 50100	0.34	1.78	57800 13000	33400 7500	1.73		283000 63600	JH211749A	JH211710
65.000 2.5591	123.825 4.8750	30.162 1.1875	143000 32200	0.38	1.56	37200 8360	24500 5500	1.52		186000 41900	478	472X
65.000 2.5591	140.000 5.5118	53.975 2.1250	321000 72300	0.32	1.85	83300 18700	46300 10400	1.80		404000 90900	J6392	J6327
65.087 2.5625	135.755 5.3447	53.975 2.1250	381000 85600	0.32	1.85	98800 22200	54900 12300	1.80		404000 90900	6379	6320
65.087 2.5625	136.525 5.3750	46.038 1.8125	319000 71700	0.47	1.27	82700 18600	67000 15100	1.24		405000 91000	H715340	H715311
65.087 2.5625	139.700 5.5000	46.038 1.8125	319000 71700	0.47	1.27	82700 18600	67000 15100	1.24		405000 91000	H715340	H715310
65.883 2.5938	122.238 4.8125	43.655 1.7187	280000 63000	0.36	1.67	72700 16300	44600 10000	1.63		327000 73500	5595	5535
66.675 2.6250	103.213 4.0635	17.247 0.6790	82900 18600	0.49	1.23	21500 4830	17900 4030	1.20		89100 20000	L812147	L812111

⁽¹⁾Based on 1 x 10⁶ revolutions L₁₀ life, for the ISO life-calculation method.

⁽²⁾Consult your Timken engineer for instructions on use or review the Timken Engineering Manual on timken.com/catalogs.

⁽³⁾Based on 90 x 10⁶ revolutions L₁₀ life, for The Timken Company life-calculation method. C₉₀ and C_{a90} are radial and thrust values.

Bearing Dimensions											Geometry Factors			Bearing Weight
Width B	Width C	Eff. Ctr. a ⁽⁴⁾	Shaft			Housing			Cage		G ₁	G ₂	C _g	
			Max Shaft Fillet Radius R ⁽⁵⁾	Backing Shoulder Dia. d _a	mm d _b	Max Housing Fillet Radius r ⁽⁵⁾	Backing Shoulder Dia. D _a	mm D _b	A _a ⁽⁶⁾	A _b ⁽⁷⁾				
mm in.	mm in.	mm in.	mm in.	mm in.	mm in.	mm in.	mm in.	mm in.	mm in.	mm in.			kg lbs.	
23.000 0.9055	18.500 0.7283	-0.3 -0.01	3.0 0.12	72.0 2.83	78.0 3.07	1.0 0.04	100.5 3.96	96.0 3.78	1.5 0.06	3.0 0.12	55.5	24.5	0.1023	0.76 1.66
28.000 1.1024	22.500 0.8858	-3.3 -0.13	3.0 0.12	72.0 2.83	78.0 3.07	2.5 0.10	105.0 4.13	99.0 3.90	1.1 0.04	2.0 0.08	76.3	23.6	0.1098	1.06 2.34
21.996 0.8660	15.875 0.6250	-0.8 -0.03	2.0 0.08	71.0 2.80	75.0 2.95	3.3 0.13	105.0 4.13	100.0 3.94	1.6 0.06	2.3 0.09	56.0	21.4	0.0984	0.84 1.85
28.000 1.1024	23.812 0.9375	-3.3 -0.13	3.0 0.12	72.0 2.83	78.0 3.07	3.3 0.13	106.0 4.17	99.0 3.90	1.1 0.04	2.0 0.08	76.3	23.6	0.1098	1.17 2.58
30.000 1.1811	23.812 0.9375	-3.3 -0.13	3.0 0.12	74.0 2.91	80.0 3.15	3.3 0.13	106.0 4.17	99.0 3.90	1.1 0.04	0.1 0.00	76.3	23.6	0.1098	1.19 2.63
29.007 1.1420	23.444 0.9230	-4.1 -0.16	2.3 0.09	73.0 2.87	77.0 3.03	3.3 0.13	114.0 4.49	106.0 4.17	1.5 0.05	2.2 0.09	77.2	23.0	0.1083	1.40 3.08
29.007 1.1420	29.000 1.1417	-4.1 -0.16	2.3 0.09	73.0 2.87	77.0 3.03	2.0 0.08	114.0 4.49	107.0 4.21	1.5 0.05	2.2 0.09	77.2	23.0	0.1083	1.48 3.27
29.007 1.1420	24.237 0.9542	-4.1 -0.16	2.3 0.09	73.0 2.87	77.0 3.03	2.0 0.08	114.0 4.49	107.0 4.21	1.5 0.05	2.2 0.09	77.2	23.0	0.1083	1.43 3.15
38.500 1.5157	32.000 1.2598	-10.8 -0.42	3.0 0.12	74.0 2.91	80.0 3.15	2.5 0.10	114.0 4.49	107.0 4.21	1.1 0.04	3.4 0.14	94.0	22.5	0.0764	1.87 4.12
38.500 1.5157	32.000 1.2598	-10.8 -0.42	7.0 0.28	74.0 2.91	88.0 3.46	2.5 0.10	114.0 4.49	107.0 4.21	1.1 0.04	3.4 0.14	94.0	22.5	0.0764	1.84 4.04
29.007 1.1420	24.605 0.9687	-4.1 -0.16	2.3 0.09	73.0 2.87	77.0 3.03	3.3 0.13	115.0 4.53	109.0 4.29	1.5 0.05	2.2 0.09	77.2	23.0	0.1083	1.57 3.46
56.000 2.2050	44.450 1.7500	-19.3 -0.76	3.0 0.12	77.0 3.04	83.0 3.27	3.3 0.13	136.0 5.35	119.0 4.69	4.0 0.15	0.5 0.02	123.5	22.4	0.0827	3.95 8.73
56.007 2.2050	44.450 1.7500	-19.3 -0.76	3.5 0.14	77.0 3.04	84.0 3.31	3.3 0.13	126.0 4.96	117.0 4.61	4.0 0.15	0.5 0.02	123.5	22.4	0.0827	3.63 8.01
46.038 1.8125	36.512 1.4375	-8.6 -0.34	3.5 0.14	83.0 3.27	89.0 3.50	3.3 0.13	132.0 5.20	118.0 4.65	4.1 0.16	2.0 0.08	147.1	33.5	0.0993	3.36 7.40
46.038 1.8125	36.512 1.4375	-8.6 -0.34	3.5 0.14	83.0 3.27	89.0 3.50	3.3 0.13	133.0 5.24	120.0 4.72	4.1 0.16	2.0 0.08	147.1	33.5	0.0993	3.54 7.80
43.764 1.7230	36.512 1.4375	-12.2 -0.48	3.5 0.14	77.0 3.03	83.0 3.27	3.3 0.13	116.0 4.57	106.0 4.17	2.5 0.09	1.3 0.05	110.4	24.2	0.0825	2.20 4.86
17.247 0.6790	11.989 0.4720	4.1 0.16	1.5 0.06	72.0 2.83	75.0 2.95	0.8 0.03	99.0 3.90	96.0 3.78	1.2 0.04	1.5 0.06	43.5	29.9	0.0958	0.50 1.10

⁽⁴⁾Negative value indicates effective center inside cone (inner-ring) backface.

⁽⁵⁾These maximum fillet radii will be cleared by the bearing corners.

⁽⁶⁾Negative value indicates cage extends beyond cone (inner-ring) backface.

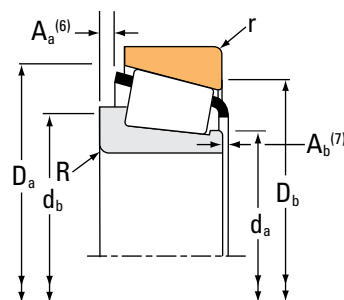
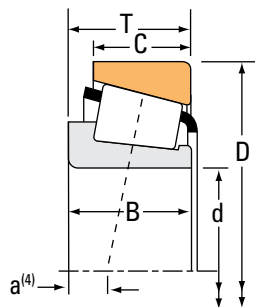
⁽⁷⁾Negative value indicates cage that does not extend beyond cone (inner-ring) front face.

Continued on next page.

TAPERED ROLLER BEARINGS

SINGLE-ROW • TYPE TS

TYPE TS



Bearing Dimensions			Load Ratings							Part Number		
Bore d	O.D. D	Width T	Dynamic ⁽¹⁾		Factors ⁽²⁾		Dynamic ⁽³⁾		Factors ⁽²⁾	Static	Inner	Outer
			C ₁	e	Y	C ₉₀	C _{a90}	K	C ₀			
mm in.	mm in.	mm in.	N lbf			N lbf	N lbf			N lbf		
66.675 2.6250	103.213 4.0635	17.602 0.6930	82900 18600	0.49	1.23	21500 4830	17900 4030	1.20		89100 20000	L812148	L812111
66.675 2.6250	107.950 4.2500	25.400 1.0000	131000 29400	0.46	1.31	33800 7610	26600 5970	1.27		161000 36300	29590	29520
66.675 2.6250	107.950 4.2500	25.400 1.0000	131000 29400	0.46	1.31	33800 7610	26600 5970	1.27		161000 36300	29590	29522
66.675 2.6250	110.000 4.3307	22.000 0.8661	98900 22200	0.40	1.49	25600 5760	17600 3970	1.45		125000 28100	395-S	394
66.675 2.6250	110.000 4.3307	22.000 0.8661	98900 22200	0.40	1.49	25600 5760	17600 3970	1.45		125000 28100	395-S	394A
66.675 2.6250	110.000 4.3307	22.000 0.8661	98900 22200	0.40	1.49	25600 5760	17600 3970	1.45		125000 28100	395A	394A
66.675 2.6250	110.000 4.3307	22.000 0.8661	98900 22200	0.40	1.49	25600 5760	17600 3970	1.45		125000 28100	395A	394
66.675 2.6250	110.000 4.3307	22.000 0.8661	98900 22200	0.40	1.49	25600 5760	17600 3970	1.45		125000 28100	395-S	394AS
66.675 2.6250	110.000 4.3307	25.400 1.0000	131000 29400	0.46	1.31	33800 7610	26600 5970	1.27		161000 36300	29590	29521
66.675 2.6250	110.000 4.3307	30.162 1.1875	139000 31200	0.40	1.49	36000 8090	24800 5570	1.45		191000 43000	3984	3927X
66.675 2.6250	110.000 4.3307	30.162 1.1875	139000 31200	0.40	1.49	36000 8090	24800 5570	1.45		191000 43000	3994	3927X
66.675 2.6250	112.712 4.4375	22.225 0.8750	98900 22200	0.40	1.49	25600 5760	17600 3970	1.45		125000 28100	395A	393A
66.675 2.6250	112.712 4.4375	26.967 1.0617	98900 22200	0.40	1.49	25600 5760	17600 3970	1.45		125000 28100	395A	3920
66.675 2.6250	112.712 4.4375	26.967 1.0617	98900 22200	0.40	1.49	25600 5760	17600 3970	1.45		125000 28100	395-S	3920
66.675 2.6250	112.712 4.4375	29.337 1.1550	139000 31200	0.40	1.49	36000 8090	24800 5570	1.45		191000 43000	3992	3920
66.675 2.6250	112.712 4.4375	30.162 1.1875	139000 31200	0.40	1.49	36000 8090	24800 5570	1.45		191000 43000	3984	3920
66.675 2.6250	112.712 4.4375	30.162 1.1875	139000 31200	0.40	1.49	36000 8090	24800 5570	1.45		191000 43000	3994	3920

⁽¹⁾Based on 1×10^6 revolutions L_{10} life, for the ISO life-calculation method.

⁽²⁾Consult your Timken engineer for instructions on use or review the Timken Engineering Manual on timken.com/catalogs.

⁽³⁾Based on 90×10^6 revolutions L_{10} life, for The Timken Company life-calculation method. C_{90} and C_{a90} are radial and thrust values.

Bearing Dimensions											Geometry Factors			Bearing Weight
Width B	Width C	Eff. Ctr. a ⁽⁴⁾	Shaft			Housing			Cage		G ₁	G ₂	C _g	
			Max Shaft Fillet Radius R ⁽⁵⁾	Backing Shoulder Dia. d _a	Shoulder Dia. d _b	Max Housing Fillet Radius r ⁽⁵⁾	Backing Shoulder Dia. D _a	Shoulder Dia. D _b	A _a ⁽⁶⁾	A _b ⁽⁷⁾				
mm in.	mm in.	mm in.	mm in.	mm in.	mm in.	mm in.	mm in.	mm in.	mm in.	mm in.				kg lbs.
17.602 0.6930	11.989 0.4720	3.6 0.14	1.5 0.06	72.0 2.83	75.0 2.95	0.8 0.03	99.0 3.90	96.0 3.78	1.6 0.06	1.5 0.06	43.5	29.9	0.0958	0.51 1.11
25.400 1.0000	19.050 0.7500	-0.8 -0.03	3.5 0.14	73.0 2.87	80.0 3.15	3.3 0.13	103.0 4.06	96.0 3.78	2.1 0.08	1.4 0.06	70.3	25.9	0.1112	0.84 1.86
25.400 1.0000	19.050 0.7500	-0.8 -0.03	3.5 0.14	73.0 2.87	80.0 3.15	0.8 0.03	103.0 4.06	98.0 3.86	2.1 0.08	1.4 0.06	70.3	25.9	0.1112	0.85 1.89
21.996 0.8660	22.000 0.8661	-0.8 -0.03	3.5 0.14	73.0 2.87	79.0 3.11	0.8 0.03	106.2 4.18	101.0 3.98	1.6 0.06	2.3 0.09	56.0	21.4	0.0984	0.80 1.77
21.996 0.8660	18.824 0.7411	-0.8 -0.03	3.5 0.14	73.0 2.87	79.0 3.11	1.3 0.05	105.0 4.13	101.0 3.98	1.6 0.06	2.3 0.09	56.0	21.4	0.0984	0.78 1.72
21.996 0.8660	18.824 0.7411	-0.8 -0.03	0.8 0.03	73.0 2.87	73.0 2.87	1.3 0.05	105.0 4.13	101.0 3.98	1.7 0.07	2.1 0.08	56.0	21.4	0.0984	0.78 1.73
21.996 0.8660	22.000 0.8661	-0.8 -0.03	0.8 0.03	73.0 2.87	73.0 2.87	0.8 0.03	106.2 4.18	101.0 3.98	1.7 0.07	2.1 0.08	56.0	21.4	0.0984	0.80 1.77
21.996 0.8660	18.824 0.7411	-0.8 -0.03	3.5 0.14	73.0 2.87	79.0 3.11	3.3 0.13	104.5 4.11	99.0 3.90	1.6 0.06	2.3 0.09	56.0	21.4	0.0984	0.77 1.69
25.400 1.0000	19.050 0.7500	-0.8 -0.03	3.5 0.14	73.0 2.87	80.0 3.15	1.3 0.05	104.0 4.09	99.0 3.90	2.1 0.08	1.4 0.06	70.3	25.9	0.1112	0.91 2.01
30.048 1.1830	23.812 0.9375	-4.6 -0.18	3.5 0.14	74.0 2.91	80.0 3.15	3.3 0.13	105.0 4.13	99.0 3.90	2.3 0.09	1.0 0.04	75.2	21.3	0.1092	1.05 2.33
30.048 1.1830	23.812 0.9375	-4.6 -0.18	5.5 0.22	75.0 2.95	86.0 3.39	3.3 0.13	105.0 4.13	99.0 3.90	2.2 0.08	1.2 0.05	75.2	21.3	0.1092	1.05 2.34
21.996 0.8660	15.875 0.6250	-0.8 -0.03	0.8 0.03	73.0 2.87	73.0 2.87	3.3 0.13	105.0 4.13	100.0 3.94	1.7 0.07	2.1 0.08	56.0	21.4	0.0984	0.81 1.79
21.996 0.8660	23.812 0.9375	-0.8 -0.03	0.8 0.03	73.0 2.87	73.0 2.87	3.3 0.13	106.0 4.17	99.0 3.90	1.7 0.07	2.1 0.08	56.0	21.4	0.0984	0.97 2.15
21.996 0.8660	23.812 0.9375	-0.8 -0.03	3.5 0.14	73.0 2.87	79.0 3.11	3.3 0.13	106.0 4.17	99.0 3.90	1.6 0.06	2.3 0.09	56.0	21.4	0.0984	0.97 2.14
29.223 1.1505	23.812 0.9375	-3.8 -0.15	5.5 0.22	75.0 2.95	86.0 3.39	3.3 0.13	106.0 4.17	99.0 3.90	1.3 0.05	1.2 0.05	75.2	21.3	0.1092	1.14 2.52
30.048 1.1830	23.812 0.9375	-4.6 -0.18	3.5 0.14	74.0 2.91	80.0 3.15	3.3 0.13	106.0 4.17	99.0 3.90	2.3 0.09	1.0 0.04	75.2	21.3	0.1092	1.15 2.55
30.048 1.1830	23.812 0.9375	-4.6 -0.18	5.5 0.22	75.0 2.95	86.0 3.39	3.3 0.13	106.0 4.17	99.0 3.90	2.2 0.08	1.2 0.05	75.2	21.3	0.1092	1.15 2.56

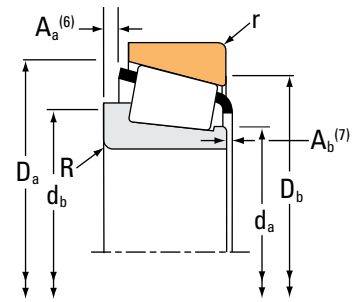
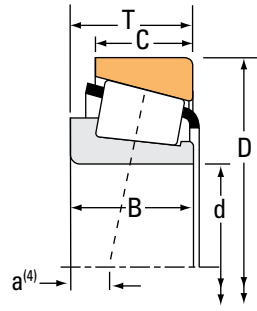
(4) Negative value indicates effective center inside cone (inner-ring) backface.
 (5) These maximum fillet radii will be cleared by the bearing corners.
 (6) Negative value indicates cage extends beyond cone (inner-ring) backface.
 (7) Negative value indicates cage that does not extend beyond cone (inner-ring) front face.

Continued on next page.

TAPERED ROLLER BEARINGS

SINGLE-ROW • TYPE TS

TYPE TS



Bearing Dimensions			Load Ratings							Part Number		
Bore d	O.D. D	Width T	Dynamic ⁽¹⁾		Factors ⁽²⁾		Dynamic ⁽³⁾		Factors ⁽²⁾	Static	Inner	Outer
			C ₁	e	Y	C ₉₀	C _{a90}	K	C ₀			
mm in.	mm in.	mm in.	N lbf			N lbf	N lbf			N lbf		
66.675 2.6250	112.712 4.4375	30.162 1.1875	167000 37500	0.34	1.77	43300 9730	25100 5650	1.72		224000 50300	39590	39520
66.675 2.6250	112.712 4.4375	30.162 1.1875	139000 31200	0.40	1.49	36000 8090	24800 5570	1.45		191000 43000	3984	3925
66.675 2.6250	112.712 4.4375	30.162 1.1875	167000 37500	0.34	1.77	43300 9730	25100 5650	1.72		224000 50300	39589	39520
66.675 2.6250	112.712 4.4375	30.162 1.1875	167000 37500	0.34	1.77	43300 9730	25100 5650	1.72		224000 50300	39590	39521
66.675 2.6250	112.712 4.4375	30.162 1.1875	167000 37500	0.34	1.77	43300 9730	25100 5650	1.72		224000 50300	39591	39520
66.675 2.6250	112.712 4.4375	30.162 1.1875	139000 31200	0.40	1.49	36000 8090	24800 5570	1.45		191000 43000	3994	3925
66.675 2.6250	112.712 4.4375	33.338 1.3125	139000 31200	0.40	1.49	36000 8090	24800 5570	1.45		191000 43000	3984	3926
66.675 2.6250	112.712 4.4375	33.338 1.3125	139000 31200	0.40	1.49	36000 8090	24800 5570	1.45		191000 43000	3994	3926
66.675 2.6250	117.475 4.6250	30.162 1.1875	138000 31100	0.44	1.38	35900 8060	26800 6020	1.34		197000 44300	33262	33462
66.675 2.6250	117.475 4.6250	30.162 1.1875	138000 31100	0.44	1.38	35900 8060	26800 6020	1.34		197000 44300	33261	33462
66.675 2.6250	117.475 4.6250	30.162 1.1875	138000 31100	0.44	1.38	35900 8060	26800 6020	1.34		197000 44300	33262	33461
66.675 2.6250	120.000 4.7244	29.002 1.1418	143000 32200	0.38	1.56	37200 8360	24500 5500	1.52		186000 41900	479	472A
66.675 2.6250	120.000 4.7244	29.794 1.1730	138000 31100	0.44	1.38	35900 8060	26800 6020	1.34		197000 44300	33262	33472
66.675 2.6250	120.000 4.7244	29.794 1.1730	143000 32200	0.38	1.56	37200 8360	24500 5500	1.52		186000 41900	479	472
66.675 2.6250	122.238 4.8125	38.100 1.5000	267000 60000	0.34	1.78	69200 15600	40000 8990	1.73		279000 62700	HM212049	HM212011
66.675 2.6250	122.238 4.8125	38.100 1.5000	267000 60000	0.34	1.78	69200 15600	40000 8990	1.73		279000 62700	HM212049	HM212010
66.675 2.6250	122.238 4.8125	38.100 1.5000	267000 60000	0.34	1.78	69200 15600	40000 8990	1.73		279000 62700	HM212049X	HM212010

⁽¹⁾Based on 1×10^6 revolutions L_{10} life, for the ISO life-calculation method.

⁽²⁾Consult your Timken engineer for instructions on use or review the Timken Engineering Manual on timken.com/catalogs.

⁽³⁾Based on 90×10^6 revolutions L_{10} life, for The Timken Company life-calculation method. C_{90} and C_{a90} are radial and thrust values.

Bearing Dimensions											Geometry Factors			Bearing Weight
Width B	Width C	Eff. Ctr. a ⁽⁴⁾	Shaft			Housing			Cage		G ₁	G ₂	C _g	
			Max Shaft Fillet Radius R ⁽⁵⁾	Backing Shoulder Dia. d _a	Shoulder Dia. d _b	Max Housing Fillet Radius r ⁽⁵⁾	Backing Shoulder Dia. D _a	Shoulder Dia. D _b	A _a ⁽⁶⁾	A _b ⁽⁷⁾				
mm in.	mm in.	mm in.	mm in.	mm in.	mm in.	mm in.	mm in.	mm in.	mm in.	mm in.				kg lbs.
30.162 1.1875	23.812 0.9375	-6.6 -0.26	3.5 0.14	75.0 2.95	82.0 3.23	3.3 0.13	107.0 4.21	101.0 3.98	1.6 0.06	2.7 0.11	84.3	23.7	0.1074	1.16 2.56
30.048 1.1830	23.812 0.9375	-4.6 -0.18	3.5 0.14	74.0 2.91	80.0 3.15	0.8 0.03	106.0 4.17	101.0 3.98	2.3 0.09	1.0 0.04	75.2	21.3	0.1092	1.16 2.56
30.162 1.1875	23.812 0.9375	-6.6 -0.26	1.5 0.06	75.0 2.95	78.0 3.07	3.3 0.13	107.0 4.21	101.0 3.98	1.6 0.06	2.7 0.11	84.3	23.7	0.1074	1.17 2.57
30.162 1.1875	23.812 0.9375	-6.6 -0.26	3.5 0.14	75.0 2.95	82.0 3.23	0.8 0.03	107.0 4.21	103.0 4.06	1.6 0.06	2.7 0.11	84.3	23.7	0.1074	1.16 2.57
30.162 1.1875	23.812 0.9375	-6.6 -0.26	5.5 0.22	74.0 2.91	84.0 3.31	3.3 0.13	107.0 4.21	101.0 3.98	1.6 0.06	2.7 0.11	84.3	23.7	0.1074	1.14 2.51
30.048 1.1830	23.812 0.9375	-4.6 -0.18	5.5 0.22	75.0 2.95	86.0 3.39	0.8 0.03	106.0 4.17	101.0 3.98	2.2 0.08	1.2 0.05	75.2	21.3	0.1092	1.16 2.57
30.048 1.1830	26.988 1.0625	-4.6 -0.18	3.5 0.14	74.0 2.91	80.0 3.15	3.3 0.13	106.0 4.17	98.0 3.86	2.3 0.09	1.0 0.04	75.2	21.3	0.1092	1.23 2.73
30.048 1.1830	26.988 1.0625	-4.6 -0.18	5.5 0.22	75.0 2.95	86.0 3.39	3.3 0.13	106.0 4.17	98.0 3.86	2.2 0.08	1.2 0.05	75.2	21.3	0.1092	1.23 2.73
30.162 1.1875	23.812 0.9375	-2.8 -0.11	3.5 0.14	75.0 2.95	81.0 3.19	3.3 0.13	112.0 4.41	104.0 4.09	2.2 0.08	1.1 0.05	84.2	25.9	0.1162	1.33 2.94
30.162 1.1875	23.812 0.9375	-2.8 -0.11	5.5 0.22	75.0 2.95	85.0 3.35	3.3 0.13	112.0 4.41	104.0 4.09	2.2 0.08	1.1 0.05	84.2	25.9	0.1162	1.32 2.90
30.162 1.1875	23.812 0.9375	-2.8 -0.11	3.5 0.14	75.0 2.95	81.0 3.19	0.8 0.03	112.0 4.41	106.0 4.17	2.2 0.08	1.1 0.05	84.2	25.9	0.1162	1.34 2.97
29.007 1.1420	23.444 0.9230	-4.1 -0.16	2.3 0.09	74.0 2.91	78.0 3.07	3.3 0.13	114.0 4.49	106.0 4.17	1.5 0.05	2.2 0.09	77.2	23.0	0.1083	1.37 3.00
30.162 1.1875	23.444 0.9230	-2.8 -0.11	3.5 0.14	75.0 2.95	81.0 3.19	0.8 0.03	113.0 4.45	107.0 4.21	2.2 0.08	1.1 0.05	84.2	25.9	0.1162	1.42 3.14
29.007 1.1420	24.237 0.9542	-4.1 -0.16	2.3 0.09	74.0 2.91	78.0 3.07	2.0 0.08	114.0 4.49	107.0 4.21	1.5 0.05	2.2 0.09	77.2	23.0	0.1083	1.40 3.07
38.354 1.5100	29.718 1.1700	-10.9 -0.43	3.5 0.14	75.5 2.97	82.0 3.23	3.3 0.13	116.0 4.57	108.0 4.25	2.2 0.08	3.1 0.12	92.2	18.1	0.0759	1.85 4.06
38.354 1.5100	29.718 1.1700	-10.9 -0.43	3.5 0.14	75.5 2.97	82.0 3.23	1.5 0.06	116.0 4.57	110.0 4.33	2.2 0.08	3.1 0.12	92.2	18.1	0.0759	1.85 4.07
38.354 1.5100	29.718 1.1700	-10.9 -0.43	7.0 0.28	75.5 2.97	89.0 3.50	1.5 0.06	116.0 4.57	110.0 4.33	2.2 0.08	3.1 0.12	92.2	18.1	0.0759	1.84 4.05

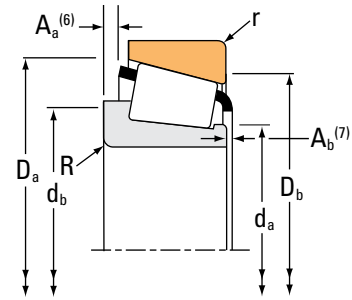
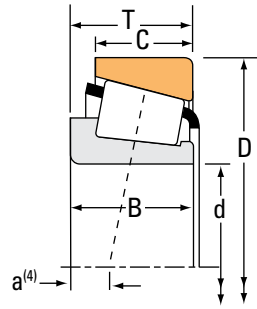
⁽⁴⁾Negative value indicates effective center inside cone (inner-ring) backface.
⁽⁵⁾These maximum fillet radii will be cleared by the bearing corners.
⁽⁶⁾Negative value indicates cage extends beyond cone (inner-ring) backface.
⁽⁷⁾Negative value indicates cage that does not extend beyond cone (inner-ring) front face.

Continued on next page.

TAPERED ROLLER BEARINGS

SINGLE-ROW • TYPE TS

TYPE TS



Bearing Dimensions			Load Ratings							Part Number			
Bore d	O.D. D	Width T	Dynamic ⁽¹⁾		Factors ⁽²⁾		Dynamic ⁽³⁾		Factors ⁽²⁾		Static C ₀	Inner	Outer
			C ₁	e	Y	C ₉₀	C _{a90}	K	N	N			
mm in.	mm in.	mm in.	N lbf			N lbf	N lbf		N lbf				
66.675 2.6250	123.825 4.8750	30.162 1.1875	143000 32200	0.38	1.56	37200 8360	24500 5500	1.52	186000 41900		479	472X	
66.675 2.6250	123.825 4.8750	38.100 1.5000	226000 50800	0.35	1.73	58600 13200	34700 7810	1.69	248000 55700		560	552	
66.675 2.6250	123.825 4.8750	38.100 1.5000	226000 50800	0.35	1.73	58600 13200	34700 7810	1.69	248000 55700		560	552A	
66.675 2.6250	127.000 5.0000	36.512 1.4375	229000 51500	0.50	1.20	59400 13400	51100 11500	1.16	256000 57600		HM813844	HM813811	
66.675 2.6250	127.000 5.0000	36.512 1.4375	229000 51500	0.50	1.20	59400 13400	51100 11500	1.16	256000 57600		HM813844	HM813810	
66.675 2.6250	129.944 5.1159	38.100 1.5000	226000 50800	0.35	1.73	58600 13200	34700 7810	1.69	248000 55700		560	553-SA	
66.675 2.6250	130.175 5.1250	41.275 1.6250	276000 62100	0.36	1.66	71600 16100	44400 9980	1.61	298000 67000		641	633	
66.675 2.6250	135.755 5.3447	53.975 2.1250	321000 72300	0.32	1.85	83300 18700	46300 10400	1.80	404000 90900		6386	6320	
66.675 2.6250	135.755 5.3447	53.975 2.1250	321000 72300	0.32	1.85	83300 18700	46300 10400	1.80	404000 90900		6389	6320	
66.675 2.6250	135.755 5.3447	53.975 2.1250	321000 72300	0.32	1.85	83300 18700	46300 10400	1.80	404000 90900		6386A	6320	
66.675 2.6250	136.525 5.3750	30.162 1.1875	154000 34700	0.44	1.35	40000 9000	30500 6850	1.31	216000 48600		495AA	493	
66.675 2.6250	136.525 5.3750	41.275 1.6250	276000 62100	0.36	1.66	71600 16100	44400 9980	1.61	298000 67000		641	632	
66.675 2.6250	136.525 5.3750	41.275 1.6250	323000 72600	0.36	1.67	83700 18800	51600 11600	1.62	335000 75400		H414242	H414210	
66.675 2.6250	136.525 5.3750	46.038 1.8125	319000 71700	0.47	1.27	82700 18600	67000 15100	1.24	405000 91000		H715341	H715311	
66.675 2.6250	136.525 5.3750	46.038 1.8125	319000 71700	0.47	1.27	82700 18600	67000 15100	1.24	405000 91000		H715341	H715311A	
66.675 2.6250	136.525 5.3750	46.038 1.8125	249000 56000	0.47	1.27	64600 14500	52300 11800	1.24	405000 91000		H715341A	H715311	
66.675 2.6250	139.700 5.5000	46.038 1.8125	319000 71700	0.47	1.27	82700 18600	67000 15100	1.24	405000 91000		H715341	H715310	

⁽¹⁾Based on 1 x 10⁶ revolutions L₁₀ life, for the ISO life-calculation method.

⁽²⁾Consult your Timken engineer for instructions on use or review the Timken Engineering Manual on timken.com/catalogs.

⁽³⁾Based on 90 x 10⁶ revolutions L₁₀ life, for The Timken Company life-calculation method. C₉₀ and C_{a90} are radial and thrust values.

Bearing Dimensions											Geometry Factors			Bearing Weight
Width B	Width C	Eff. Ctr. a ⁽⁴⁾	Shaft			Housing			Cage		G ₁	G ₂	C _g	
			Max Shaft Fillet Radius R ⁽⁵⁾	Backing Shoulder Dia. d _a	Shoulder Dia. d _b	Max Housing Fillet Radius r ⁽⁵⁾	Backing Shoulder Dia. D _a	Shoulder Dia. D _b	A _a ⁽⁶⁾	A _b ⁽⁷⁾				
mm in.	mm in.	mm in.	mm in.	mm in.	mm in.	mm in.	mm in.	mm in.	mm in.	mm in.				kg lbs.
29.007 1.1420	24.605 0.9687	-4.1 -0.16	2.3 0.09	74.0 2.91	78.0 3.07	3.3 0.13	115.0 4.53	109.0 4.29	1.5 0.05	2.2 0.09	77.2	23.0	0.1083	1.54 3.37
36.678 1.4440	33.338 1.3125	-9.4 -0.37	3.5 0.14	77.0 3.03	84.0 3.31	3.3 0.13	116.0 4.57	109.0 4.29	2.3 0.09	1.3 0.05	91.0	21.1	0.1108	1.94 4.27
36.678 1.4440	30.162 1.1875	-9.4 -0.37	3.5 0.14	77.0 3.03	84.0 3.31	3.3 0.13	116.0 4.57	109.0 4.29	2.3 0.09	1.3 0.05	91.0	21.1	0.1108	1.89 4.16
36.512 1.4375	26.988 1.0625	-3.8 -0.15	3.5 0.14	82.0 3.23	88.0 3.46	1.5 0.06	121.0 4.76	113.0 4.45	4.0 0.15	1.3 0.06	91.7	22.9	0.1252	1.99 4.41
36.512 1.4375	26.988 1.0625	-3.8 -0.15	3.5 0.14	82.0 3.23	88.0 3.46	3.3 0.13	121.0 4.76	111.0 4.37	4.0 0.15	1.3 0.06	91.7	22.9	0.1252	1.99 4.40
36.678 1.4440	30.162 1.1875	-9.4 -0.37	3.5 0.14	77.0 3.03	84.0 3.31	3.3 0.13	116.0 4.57	111.0 4.37	2.3 0.09	1.3 0.05	91.0	21.1	0.1108	2.18 4.79
41.275 1.6250	31.750 1.2500	-11.2 -0.44	3.5 0.14	77.0 3.03	83.0 3.27	3.3 0.13	124.0 4.88	116.0 4.57	4.1 0.16	2.0 0.08	106.4	21.0	0.0814	2.38 5.24
56.007 2.2050	44.450 1.7500	-19.3 -0.76	4.3 0.17	77.0 3.04	87.0 3.43	3.3 0.13	126.0 4.96	117.0 4.61	4.0 0.15	0.5 0.02	123.5	22.4	0.0827	3.55 7.84
56.007 2.2050	44.450 1.7500	-19.3 -0.76	6.4 0.25	77.0 3.04	91.0 3.58	3.3 0.13	126.0 4.96	117.0 4.61	4.0 0.15	0.5 0.02	123.5	22.4	0.0827	3.53 7.80
56.007 2.2050	44.450 1.7500	-19.3 -0.76	8.7 0.34	77.0 3.04	96.0 3.78	3.3 0.13	126.0 4.96	117.0 4.61	4.0 0.15	0.5 0.02	123.5	22.4	0.0827	3.50 7.72
29.769 1.1720	22.225 0.8750	-0.8 -0.03	3.5 0.14	78.0 3.07	85.0 3.35	3.3 0.13	130.0 5.12	122.0 4.80	2.5 0.09	2.2 0.09	104.6	29.3	0.1252	2.05 4.51
41.275 1.6250	31.750 1.2500	-11.2 -0.44	3.5 0.14	77.0 3.03	83.0 3.27	3.3 0.13	125.0 4.92	118.0 4.65	4.1 0.16	2.0 0.08	106.4	21.0	0.0814	2.72 5.99
41.275 1.6250	31.750 1.2500	-10.9 -0.43	3.5 0.14	81.0 3.19	85.0 3.35	3.3 0.13	129.0 5.08	121.0 4.76	3.7 0.14	3.1 0.12	112.8	22.9	0.0827	2.71 5.99
46.038 1.8125	36.512 1.4375	-8.6 -0.34	3.5 0.14	85.0 3.35	91.0 3.58	3.3 0.13	132.0 5.20	118.0 4.65	4.1 0.16	2.0 0.08	147.1	33.5	0.0993	3.30 7.27
46.038 1.8125	36.512 1.4375	-8.6 -0.34	3.5 0.14	85.0 3.35	91.0 3.58	0.8 0.03	132.0 5.20	121.0 4.76	4.1 0.16	2.0 0.08	147.1	33.5	0.0993	3.30 7.27
46.038 1.8125	36.512 1.4375	-8.6 -0.34	7.0 0.28	85.0 3.35	98.0 3.86	3.3 0.13	132.0 5.20	118.0 4.65	4.1 0.16	2.0 0.08	147.1	33.5	0.0993	3.28 7.23
46.038 1.8125	36.512 1.4375	-8.6 -0.34	3.5 0.14	85.0 3.35	91.0 3.58	3.3 0.13	133.0 5.24	120.0 4.72	4.1 0.16	2.0 0.08	147.1	33.5	0.0993	3.48 7.67

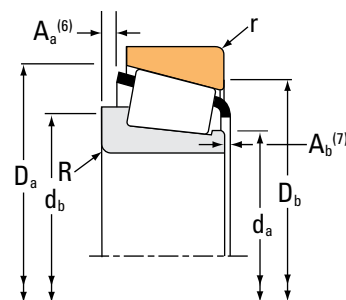
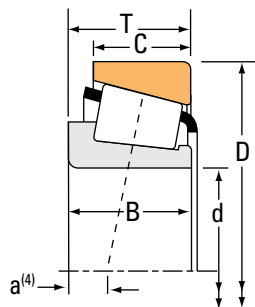
(4) Negative value indicates effective center inside cone (inner-ring) backface.
 (5) These maximum fillet radii will be cleared by the bearing corners.
 (6) Negative value indicates cage extends beyond cone (inner-ring) backface.
 (7) Negative value indicates cage that does not extend beyond cone (inner-ring) front face.

Continued on next page.

TAPERED ROLLER BEARINGS

SINGLE-ROW • TYPE TS

TYPE TS



Bearing Dimensions			Load Ratings							Part Number			
Bore d	O.D. D	Width T	Dynamic ⁽¹⁾		Factors ⁽²⁾		Dynamic ⁽³⁾		Factors ⁽²⁾		Static C ₀	Inner	Outer
			C ₁	e	Y	C ₉₀	C _{a90}	K	N	N			
mm in.	mm in.	mm in.	N lbf			N lbf	N lbf		N lbf				
66.675 2.6250	152.400 6.0000	53.975 2.1250	339000 76100	0.49	1.23	87800 19700	73200 16500	1.20	423000 95000		HH814547	HH814510	
66.675 2.6250	177.800 7.0000	57.150 2.2500	451000 101000	0.80	0.75	117000 26300	160000 35900	0.73	413000 92900		HH914449	HH914412	
68.262 2.6875	110.000 4.3307	22.000 0.8661	98900 22200	0.40	1.49	25600 5760	17600 3970	1.45	125000 28100		399A	394A	
68.262 2.6875	110.000 4.3307	22.000 0.8661	98900 22200	0.40	1.49	25600 5760	17600 3970	1.45	125000 28100		399AS	394A	
68.262 2.6875	111.125 4.3750	22.000 0.8661	98900 22200	0.40	1.49	25600 5760	17600 3970	1.45	125000 28100		399A	393AS	
68.262 2.6875	112.712 4.4375	26.967 1.0617	98900 22200	0.40	1.49	25600 5760	17600 3970	1.45	125000 28100		399AS	3920	
68.262 2.6875	112.712 4.4375	26.967 1.0617	98900 22200	0.40	1.49	25600 5760	17600 3970	1.45	125000 28100		399A	3920	
68.262 2.6875	120.000 4.7244	29.002 1.1418	143000 32200	0.38	1.56	37200 8360	24500 5500	1.52	186000 41900		480	472A	
68.262 2.6875	120.000 4.7244	29.794 1.1730	143000 32200	0.38	1.56	37200 8360	24500 5500	1.52	186000 41900		480	473	
68.262 2.6875	120.000 4.7244	29.794 1.1730	138000 31100	0.44	1.38	35900 8060	26800 6020	1.34	197000 44300		33269	33472	
68.262 2.6875	120.000 4.7244	29.795 1.1730	143000 32200	0.38	1.56	37200 8360	24500 5500	1.52	186000 41900		480	472	
68.262 2.6875	123.825 4.8750	34.912 1.3745	191000 42900	0.35	1.73	49400 11100	29300 6590	1.69	248000 55700		560-S	552-S	
68.262 2.6875	123.825 4.8750	38.100 1.5000	191000 42900	0.35	1.73	49400 11100	29300 6590	1.69	248000 55700		560-S	552A	
68.262 2.6875	123.825 4.8750	38.100 1.5000	191000 42900	0.35	1.73	49400 11100	29300 6590	1.69	248000 55700		560-S	552	
68.262 2.6875	127.000 5.0000	36.512 1.4375	196000 44100	0.36	1.65	50900 11400	31700 7130	1.61	262000 58900		570	563	
68.262 2.6875	130.048 5.1200	36.512 1.4375	196000 44100	0.36	1.65	50900 11400	31700 7130	1.61	262000 58900		570	562	
68.262 2.6875	130.175 5.1250	41.275 1.6250	233000 52400	0.36	1.66	60400 13600	37400 8420	1.61	298000 67000		642	633	

⁽¹⁾Based on 1 x 10⁶ revolutions L₁₀ life, for the ISO life-calculation method.

⁽²⁾Consult your Timken engineer for instructions on use or review the Timken Engineering Manual on timken.com/catalogs.

⁽³⁾Based on 90 x 10⁶ revolutions L₁₀ life, for The Timken Company life-calculation method. C₉₀ and C_{a90} are radial and thrust values.

Bearing Dimensions											Geometry Factors			Bearing Weight
Width B	Width C	Eff. Ctr. a ⁽⁴⁾	Shaft			Housing			Cage		G ₁	G ₂	C _g	
			Max Shaft Fillet Radius R ⁽⁵⁾	Backing Shoulder Dia. d _a	Shoulder Dia. d _b	Max Housing Fillet Radius r ⁽⁵⁾	Backing Shoulder Dia. D _a	Shoulder Dia. D _b	A _a ⁽⁶⁾	A _b ⁽⁷⁾				
mm in.	mm in.	mm in.	mm in.	mm in.	mm in.	mm in.	mm in.	mm in.	mm in.	mm in.				kg lbs.
57.150 2.2500	41.275 1.6250	-12.2 -0.48	3.5 0.14	85.0 3.35	93.0 3.66	3.3 0.13	143.0 5.63	130.0 5.12	5.2 0.20	0.2 0.01	129.7	23.6	0.0957	4.80 10.57
53.975 2.1250	37.308 1.4688	-0.3 -0.01	3.5 0.14	85.3 3.36	106.0 4.17	3.3 0.13	165.0 6.50	146.0 5.75	9.8 0.38	4.7 0.19	111.4	17.8	0.1044	6.66 14.66
21.996 0.8660	18.824 0.7411	-0.8 -0.03	2.3 0.09	74.0 2.91	78.0 3.07	1.3 0.05	105.0 4.13	101.0 3.98	1.7 0.07	2.1 0.08	56.0	21.4	0.0984	0.75 1.65
21.996 0.8660	18.824 0.7411	-0.8 -0.03	5.0 0.20	74.0 2.91	83.0 3.27	1.3 0.05	105.0 4.13	101.0 3.98	1.6 0.06	2.3 0.09	56.0	21.4	0.0984	0.73 1.61
21.996 0.8660	18.824 0.7411	-0.8 -0.03	2.3 0.09	74.0 2.91	78.0 3.07	1.3 0.05	105.0 4.13	101.0 3.98	1.7 0.07	2.1 0.08	56.0	21.4	0.0984	0.78 1.71
21.996 0.8660	23.812 0.9375	-0.8 -0.03	5.0 0.20	74.0 2.91	83.0 3.27	3.3 0.13	106.0 4.17	99.0 3.90	1.6 0.06	2.3 0.09	56.0	21.4	0.0984	0.92 2.03
21.996 0.8660	23.812 0.9375	-0.8 -0.03	2.3 0.09	74.0 2.91	78.0 3.07	3.3 0.13	106.0 4.17	99.0 3.90	1.7 0.07	2.1 0.08	56.0	21.4	0.0984	0.94 2.07
29.007 1.1420	23.444 0.9230	-4.1 -0.16	3.5 0.14	75.0 2.95	82.0 3.23	3.3 0.13	114.0 4.49	106.0 4.17	1.5 0.05	2.2 0.09	77.2	23.0	0.1083	1.32 2.90
29.007 1.1420	29.000 1.1417	-4.1 -0.16	3.5 0.14	75.0 2.95	82.0 3.23	2.0 0.08	114.0 4.49	107.0 4.21	1.5 0.05	2.2 0.09	77.2	23.0	0.1083	1.40 3.08
30.162 1.1875	23.444 0.9230	-2.8 -0.11	3.5 0.14	76.0 2.99	82.0 3.23	0.8 0.03	113.0 4.45	107.0 4.21	2.2 0.08	1.1 0.05	84.2	25.9	0.1162	1.38 3.05
29.007 1.1420	24.237 0.9542	-4.1 -0.16	3.5 0.14	75.0 2.95	82.0 3.23	2.0 0.08	114.0 4.49	107.0 4.21	1.5 0.05	2.2 0.09	77.2	23.0	0.1083	1.35 2.97
36.678 1.4440	26.975 1.0620	-9.4 -0.37	3.5 0.14	76.0 2.99	83.0 3.27	4.8 0.19	115.0 4.53	107.0 4.21	2.3 0.09	1.3 0.05	91.0	21.1	0.1108	1.72 3.77
36.678 1.4440	30.162 1.1875	-9.4 -0.37	3.5 0.14	76.0 2.99	83.0 3.27	3.3 0.13	116.0 4.57	109.0 4.29	2.3 0.09	1.3 0.05	91.0	21.1	0.1108	1.84 4.04
36.678 1.4440	33.338 1.3125	-9.4 -0.37	3.5 0.14	76.0 2.99	83.0 3.27	3.3 0.13	116.0 4.57	109.0 4.29	2.3 0.09	1.3 0.05	91.0	21.1	0.1108	1.89 4.15
36.170 1.4240	28.575 1.1250	-8.1 -0.32	3.5 0.14	77.0 3.03	83.0 3.27	3.3 0.13	120.0 4.72	112.0 4.41	3.2 0.12	1.8 0.08	101.3	24.0	0.1167	1.95 4.31
36.170 1.4240	28.575 1.1250	-8.1 -0.32	3.5 0.14	77.0 3.03	83.0 3.27	0.8 0.03	121.0 4.76	116.0 4.57	3.2 0.12	1.8 0.08	101.3	24.0	0.1167	2.10 4.62
41.275 1.6250	31.750 1.2500	-11.2 -0.44	3.5 0.14	78.0 3.07	85.0 3.35	3.3 0.13	124.0 4.88	116.0 4.57	4.1 0.16	2.0 0.08	106.4	21.0	0.0814	2.33 5.12

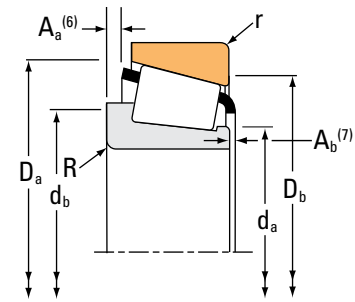
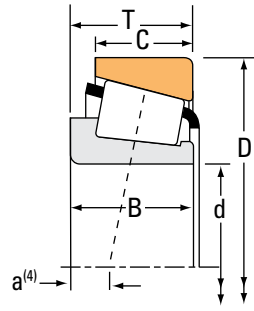
(4) Negative value indicates effective center inside cone (inner-ring) backface.
 (5) These maximum fillet radii will be cleared by the bearing corners.
 (6) Negative value indicates cage extends beyond cone (inner-ring) backface.
 (7) Negative value indicates cage that does not extend beyond cone (inner-ring) front face.

Continued on next page.

TAPERED ROLLER BEARINGS

SINGLE-ROW • TYPE TS

TYPE TS



Bearing Dimensions			Load Ratings							Part Number			
Bore d	O.D. D	Width T	Dynamic ⁽¹⁾		Factors ⁽²⁾		Dynamic ⁽³⁾		Factors ⁽²⁾		Static C ₀	Inner	Outer
			C ₁	e	Y	C ₉₀	C _{a90}	K	N	N			
mm in.	mm in.	mm in.	N lbf			N lbf	N lbf		N lbf				
68.262 2.6875	136.525 5.3750	41.275 1.6250	233000 52400	0.36	1.66	60400 13600	37400 8420	1.61	298000 67000			642	632
68.262 2.6875	136.525 5.3750	41.275 1.6250	323000 72600	0.36	1.67	83700 18800	51600 11600	1.62	335000 75400			H414245X	H414210
68.262 2.6875	136.525 5.3750	46.038 1.8125	319000 71700	0.47	1.27	82700 18600	67000 15100	1.24	405000 91000			H715343	H715311
68.262 2.6875	139.700 5.5000	46.038 1.8125	319000 71700	0.47	1.27	82700 18600	67000 15100	1.24	405000 91000			H715343	H715310
68.262 2.6875	152.400 6.0000	47.625 1.8750	338000 76000	0.66	0.91	87700 19700	98500 22100	0.89	306000 68700			9185	9121
68.262 2.6875	152.400 6.0000	47.625 1.8750	328000 73700	0.90	0.67	85000 19100	131000 29500	0.65	401000 90100			H914841	H914811
68.262 2.6875	158.750 6.2500	50.800 2.0000	338000 76000	0.66	0.91	87700 19700	98500 22100	0.89	306000 68700			9185	9120
68.262 2.6875	161.925 6.3750	49.212 1.9375	353000 79300	0.71	0.85	91400 20600	111000 24900	0.82	330000 74200			9278	9220
69.850 2.7500	98.425 3.8750	13.495 0.5313	40300 9070	0.44	1.37	10500 2350	7840 1760	1.33	58100 13100			LL713049	LL713010
69.850 2.7500	99.217 3.9062	17.000 0.6693	48800 11000	0.46	1.29	12700 2850	10100 2260	1.26	75000 16900			LL713149	LL713110
69.850 2.7500	101.600 4.0000	19.050 0.7500	61900 13900	0.46	1.30	16000 3610	12700 2850	1.27	111000 25000			L713049	L713010
69.850 2.7500	112.712 4.4375	22.225 0.8750	101000 22700	0.42	1.44	26200 5880	18600 4190	1.40	130000 29300			LM613449	LM613410
69.850 2.7500	112.712 4.4375	25.400 1.0000	111000 24800	0.49	1.23	28600 6440	23900 5370	1.20	166000 37200			29675	29620
69.850 2.7500	114.300 4.5000	27.780 1.0937	111000 24800	0.49	1.23	28600 6440	23900 5370	1.20	166000 37200			29675	29624
69.850 2.7500	117.475 4.6250	30.162 1.1875	138000 31100	0.44	1.38	35900 8060	26800 6020	1.34	197000 44300			33275	33462
69.850 2.7500	120.000 4.7244	29.002 1.1418	143000 32200	0.38	1.56	37200 8360	24500 5500	1.52	186000 41900			482	472A
69.850 2.7500	120.000 4.7244	29.002 1.1418	133000 29900	0.38	1.56	34400 7740	22700 5100	1.52	186000 41900			482A	472A

⁽¹⁾Based on 1 x 10⁶ revolutions L₁₀ life, for the ISO life-calculation method.

⁽²⁾Consult your Timken engineer for instructions on use or review the Timken Engineering Manual on timken.com/catalogs.

⁽³⁾Based on 90 x 10⁶ revolutions L₁₀ life, for The Timken Company life-calculation method. C₉₀ and C_{a90} are radial and thrust values.

Bearing Dimensions											Geometry Factors			Bearing Weight
Width B	Width C	Eff. Ctr. a ⁽⁴⁾	Shaft			Housing			Cage		G ₁	G ₂	C _g	
			Max Shaft Fillet Radius R ⁽⁵⁾	Backing Shoulder Dia. d _a	mm in.	Max Housing Fillet Radius r ⁽⁵⁾	Backing Shoulder Dia. D _a	mm in.	A _a ⁽⁶⁾	A _b ⁽⁷⁾				
mm in.	mm in.	mm in.	mm in.	mm in.	mm in.	mm in.	mm in.	mm in.	mm in.	mm in.			kg lbs.	
41.275 1.6250	31.750 1.2500	-11.2 -0.44	3.5 0.14	78.0 3.07	85.0 3.35	3.3 0.13	125.0 4.92	118.0 4.65	4.1 0.16	2.0 0.08	106.4	21.0	0.0814	2.67 5.87
41.275 1.6250	31.750 1.2500	-10.9 -0.43	9.7 0.38	82.0 3.23	98.0 3.86	3.3 0.13	129.0 5.08	121.0 4.76	3.7 0.14	3.1 0.12	112.8	22.9	0.0827	2.58 5.70
46.038 1.8125	36.512 1.4375	-8.6 -0.34	3.5 0.14	86.0 3.39	92.0 3.62	3.3 0.13	132.0 5.20	118.0 4.65	4.1 0.16	2.0 0.08	147.1	33.5	0.0993	3.24 7.13
46.038 1.8125	36.512 1.4375	-8.6 -0.34	3.5 0.14	86.0 3.39	92.0 3.62	3.3 0.13	133.0 5.24	120.0 4.72	4.1 0.16	2.0 0.08	147.1	33.5	0.0993	3.42 7.53
46.038 1.8125	31.750 1.2500	-3.8 -0.15	3.5 0.14	81.3 3.20	94.0 3.70	3.3 0.13	145.0 5.71	130.0 5.12	8.1 0.31	4.1 0.16	87.6	13.7	0.0912	3.75 8.26
46.038 1.8125	35.100 1.3819	7.9 0.31	3.5 0.14	87.0 3.43	108.0 4.25	3.3 0.13	148.0 5.83	123.0 4.84	5.7 0.22	3.2 0.13	135.1	30.3	0.1165	4.40 9.68
46.038 1.8125	34.925 1.3750	-3.8 -0.15	3.5 0.14	81.3 3.20	94.0 3.70	3.3 0.13	146.0 5.75	131.0 5.16	8.1 0.31	4.1 0.16	87.6	13.7	0.0912	4.37 9.63
46.038 1.8125	31.750 1.2500	0.0 0.00	3.5 0.14	89.0 3.50	106.0 4.17	3.3 0.13	153.0 6.03	138.0 5.43	9.0 0.35	4.1 0.16	102.5	16.1	0.0984	4.50 9.93
13.495 0.5313	9.525 0.3750	4.6 0.18	1.5 0.06	74.0 2.91	77.0 3.03	1.5 0.06	94.0 3.70	92.0 3.62	1.0 0.04	1.5 0.06	39.9	55.0	0.0893	0.30 0.65
16.000 0.6299	13.000 0.5118	4.6 0.18	1.5 0.06	75.0 2.95	77.0 3.03	1.5 0.06	95.0 3.74	91.0 3.58	0.6 0.02	0.6 0.03	47.9	56.5	0.0972	0.39 0.85
19.050 0.7500	15.083 0.5938	2.5 0.10	1.5 0.06	75.0 2.95	78.0 3.07	1.5 0.06	98.0 3.86	93.0 3.66	0.8 0.03	1.4 0.06	64.3	58.3	0.1075	0.51 1.11
21.996 0.8660	15.875 0.6250	0.0 0.00	1.5 0.06	76.0 2.99	78.0 3.07	0.8 0.03	107.0 4.21	104.0 4.09	1.7 0.06	2.3 0.09	60.3	23.1	0.1019	0.77 1.71
25.400 1.0000	19.050 0.7500	1.0 0.04	1.5 0.06	77.0 3.03	80.0 3.15	3.3 0.13	109.0 4.29	101.0 3.98	2.3 0.09	1.5 0.06	77.7	43.3	0.1170	0.95 2.11
25.400 1.0000	22.225 0.8750	1.0 0.04	1.5 0.06	77.0 3.03	80.0 3.15	3.3 0.13	109.0 4.29	103.0 4.06	2.3 0.09	1.5 0.06	77.7	43.3	0.1170	1.06 2.34
30.162 1.1875	23.812 0.9375	-2.8 -0.11	3.5 0.14	79.0 3.11	85.0 3.35	3.3 0.13	112.0 4.41	104.0 4.09	2.2 0.08	1.1 0.05	84.2	25.9	0.1162	1.26 2.78
29.007 1.1420	23.444 0.9230	-4.1 -0.16	3.5 0.14	77.0 3.03	83.0 3.27	3.3 0.13	114.0 4.49	106.0 4.17	1.5 0.05	2.2 0.09	77.2	23.0	0.1083	1.28 2.81
29.007 1.1420	23.444 0.9230	-4.1 -0.16	4.8 0.19	77.0 3.03	86.0 3.39	3.3 0.13	114.0 4.49	106.0 4.17	1.5 0.05	2.2 0.09	77.2	23.0	0.1083	1.27 2.79

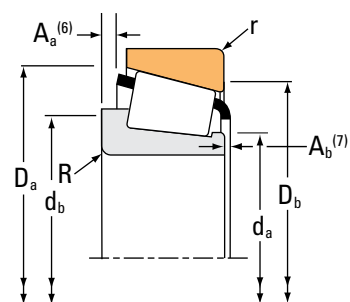
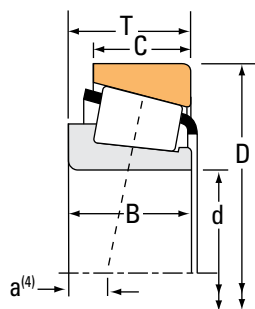
⁽⁴⁾Negative value indicates effective center inside cone (inner-ring) backface.
⁽⁵⁾These maximum fillet radii will be cleared by the bearing corners.
⁽⁶⁾Negative value indicates cage extends beyond cone (inner-ring) backface.
⁽⁷⁾Negative value indicates cage that does not extend beyond cone (inner-ring) front face.

Continued on next page.

TAPERED ROLLER BEARINGS

SINGLE-ROW • TYPE TS

TYPE TS



Bearing Dimensions			Load Ratings							Part Number		
Bore d	O.D. D	Width T	Dynamic ⁽¹⁾		Factors ⁽²⁾		Dynamic ⁽³⁾		Factors ⁽²⁾	Static	Inner	Outer
			C ₁	e	Y	C ₉₀	C _{a90}	K	C ₀			
mm in.	mm in.	mm in.	N lbf			N lbf	N lbf			N lbf		
69.850 2.7500	120.000 4.7244	29.794 1.1730	143000 32200	0.38	1.56	37200 8360	24500 5500	1.52		186000 41900	482	473
69.850 2.7500	120.000 4.7244	29.794 1.1730	143000 32200	0.38	1.56	37200 8360	24500 5500	1.52		186000 41900	482	472
69.850 2.7500	120.000 4.7244	29.794 1.1730	138000 31100	0.44	1.38	35900 8060	26800 6020	1.34		197000 44300	33275	33472
69.850 2.7500	120.000 4.7244	32.545 1.2813	179000 40200	0.36	1.67	46300 10400	28600 6420	1.62		249000 56000	47487	47420
69.850 2.7500	120.000 4.7244	32.545 1.2813	179000 40200	0.36	1.67	46300 10400	28600 6420	1.62		249000 56000	47487	47420A
69.850 2.7500	120.650 4.7500	25.400 1.0000	111000 24800	0.49	1.23	28600 6440	23900 5370	1.20		166000 37200	29675	29630
69.850 2.7500	123.825 4.8750	30.162 1.1875	143000 32200	0.38	1.56	37200 8360	24500 5500	1.52		186000 41900	482	472X
69.850 2.7500	127.000 5.0000	36.512 1.4375	196000 44100	0.36	1.65	50900 11400	31700 7130	1.61		262000 58900	566	563
69.850 2.7500	127.000 5.0000	36.512 1.4375	196000 44100	0.36	1.65	50900 11400	31700 7130	1.61		262000 58900	566-S	563
69.850 2.7500	127.000 5.0000	36.512 1.4375	229000 51500	0.50	1.20	59400 13400	51100 11500	1.16		256000 57600	HM813846	HM813811
69.850 2.7500	127.000 5.0000	36.512 1.4375	229000 51500	0.50	1.20	59400 13400	51100 11500	1.16		256000 57600	HM813846	HM813810
69.850 2.7500	130.175 5.1250	41.275 1.6250	276000 62100	0.36	1.66	71600 16100	44400 9980	1.61		298000 67000	643	633
69.850 2.7500	136.525 5.3750	41.275 1.6250	276000 62100	0.36	1.66	71600 16100	44400 9980	1.61		298000 67000	643	632
69.850 2.7500	139.700 5.5000	46.038 1.8125	319000 71700	0.47	1.27	82700 18600	67000 15100	1.24		405000 91000	H715344	H715310
69.850 2.7500	146.050 5.7500	36.512 1.4375	174000 39100	0.94	0.64	45000 10100	72300 16200	0.62		202000 45400	HM914545	HM914510
69.850 2.7500	146.050 5.7500	41.275 1.6250	273000 61300	0.78	0.77	70700 15900	94700 21300	0.75		256000 57500	H913849	H913810
69.850 2.7500	146.050 5.7500	41.275 1.6250	247000 55500	0.41	1.47	64000 14400	44800 10100	1.43		335000 75300	655	653

⁽¹⁾Based on 1 x 10⁶ revolutions L₁₀ life, for the ISO life-calculation method.

⁽²⁾Consult your Timken engineer for instructions on use or review the Timken Engineering Manual on timken.com/catalogs.

⁽³⁾Based on 90 x 10⁶ revolutions L₁₀ life, for The Timken Company life-calculation method. C₉₀ and C_{a90} are radial and thrust values.

Bearing Dimensions											Geometry Factors			Bearing Weight
Width B	Width C	Eff. Ctr. a ⁽⁴⁾	Shaft			Housing			Cage		G ₁	G ₂	C _g	
			Max Shaft Fillet Radius R ⁽⁵⁾	Backing Shoulder Dia. d _a	Shoulder Dia. d _b	Max Housing Fillet Radius r ⁽⁵⁾	Backing Shoulder Dia. D _a	Shoulder Dia. D _b	A _a ⁽⁶⁾	A _b ⁽⁷⁾				
mm in.	mm in.	mm in.	mm in.	mm in.	mm in.	mm in.	mm in.	mm in.	mm in.	mm in.				kg lbs.
29.007 1.1420	29.000 1.1417	-4.1 -0.16	3.5 0.14	77.0 3.03	83.0 3.27	2.0 0.08	114.0 4.49	107.0 4.21	1.5 0.05	2.2 0.09	77.2	23.0	0.1083	1.36 2.99
29.007 1.1420	24.237 0.9542	-4.1 -0.16	3.5 0.14	77.0 3.03	83.0 3.27	2.0 0.08	114.0 4.49	107.0 4.21	1.5 0.05	2.2 0.09	77.2	23.0	0.1083	1.31 2.88
30.162 1.1875	23.444 0.9230	-2.8 -0.11	3.5 0.14	79.0 3.11	85.0 3.35	0.8 0.03	113.0 4.45	107.0 4.21	2.2 0.08	1.1 0.05	84.2	25.9	0.1162	1.35 2.97
32.545 1.2813	26.195 1.0313	-6.4 -0.25	3.5 0.14	78.0 3.07	84.0 3.31	3.3 0.13	114.0 4.49	107.0 4.21	2.2 0.08	2.0 0.08	98.4	26.3	0.1153	1.46 3.20
32.545 1.2813	26.195 1.0313	-6.4 -0.25	3.5 0.14	78.0 3.07	84.0 3.31	0.5 0.02	114.0 4.49	109.0 4.29	2.2 0.08	2.0 0.08	98.4	26.3	0.1153	1.48 3.24
25.400 1.0000	19.050 0.7500	1.0 0.04	1.5 0.06	77.0 3.03	80.0 3.15	3.3 0.13	113.0 4.45	104.0 4.09	2.3 0.09	1.5 0.06	77.7	43.3	0.1170	1.16 2.57
29.007 1.1420	24.605 0.9687	-4.1 -0.16	3.5 0.14	77.0 3.03	83.0 3.27	3.3 0.13	115.0 4.53	109.0 4.29	1.5 0.05	2.2 0.09	77.2	23.0	0.1083	1.45 3.19
36.170 1.4240	28.575 1.1250	-8.1 -0.32	3.5 0.14	78.0 3.07	85.0 3.35	3.3 0.13	120.0 4.72	112.0 4.41	3.2 0.12	1.8 0.08	101.3	24.0	0.1167	1.90 4.20
36.170 1.4240	28.575 1.1250	-8.1 -0.32	0.8 0.03	78.0 3.07	79.0 3.11	3.3 0.13	120.0 4.72	112.0 4.41	3.2 0.12	1.8 0.08	101.3	24.0	0.1167	1.91 4.23
36.512 1.4375	26.988 1.0625	-3.8 -0.15	3.5 0.14	82.0 3.23	89.0 3.50	1.5 0.06	121.0 4.76	113.0 4.45	4.0 0.15	1.3 0.06	91.7	22.9	0.1252	1.90 4.19
36.512 1.4375	26.988 1.0625	-3.8 -0.15	3.5 0.14	82.0 3.23	89.0 3.50	3.3 0.13	121.0 4.76	111.0 4.37	4.0 0.15	1.3 0.06	91.7	22.9	0.1252	1.90 4.19
41.275 1.6250	31.750 1.2500	-11.2 -0.44	3.5 0.14	80.0 3.15	86.0 3.39	3.3 0.13	124.0 4.88	116.0 4.57	4.1 0.16	2.0 0.08	106.4	21.0	0.0814	2.27 5.00
41.275 1.6250	31.750 1.2500	-11.2 -0.44	3.5 0.14	80.0 3.15	86.0 3.39	3.3 0.13	125.0 4.92	118.0 4.65	4.1 0.16	2.0 0.08	106.4	21.0	0.0814	2.61 5.75
46.038 1.8125	36.512 1.4375	-8.6 -0.34	3.5 0.14	87.0 3.43	93.0 3.66	3.3 0.13	133.0 5.24	120.0 4.72	4.1 0.16	2.0 0.08	147.1	33.5	0.0993	3.35 7.40
33.338 1.3125	23.812 0.9375	12.4 0.49	4.0 0.16	86.1 3.38	95.0 3.74	3.3 0.13	139.0 5.47	122.0 4.80	7.1 0.28	4.6 0.18	71.5	21.8	0.0943	2.57 5.66
39.688 1.5625	25.400 1.0000	4.3 0.17	3.5 0.14	82.4 3.24	95.0 3.74	3.3 0.13	138.0 5.43	124.0 4.88	8.2 0.32	3.6 0.14	78.5	17.3	0.0927	2.87 6.33
41.275 1.6250	31.750 1.2500	-7.9 -0.31	3.5 0.14	82.0 3.23	88.0 3.46	3.3 0.13	139.0 5.47	131.0 5.16	4.5 0.17	2.1 0.08	136.6	27.3	0.0919	3.24 7.15

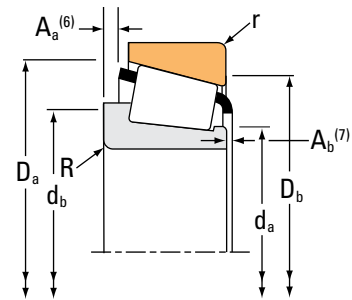
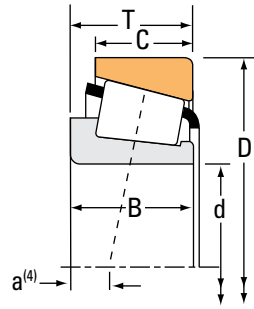
(4) Negative value indicates effective center inside cone (inner-ring) backface.
 (5) These maximum fillet radii will be cleared by the bearing corners.
 (6) Negative value indicates cage extends beyond cone (inner-ring) backface.
 (7) Negative value indicates cage that does not extend beyond cone (inner-ring) front face.

Continued on next page.

TAPERED ROLLER BEARINGS

SINGLE-ROW • TYPE TS

TYPE TS



Bearing Dimensions			Load Ratings							Part Number			
Bore d	O.D. D	Width T	Dynamic ⁽¹⁾		Factors ⁽²⁾		Dynamic ⁽³⁾		Factors ⁽²⁾		Static C ₀	Inner	Outer
			C ₁	e	Y	C ₉₀	C _{a90}	K	N	N			
mm in.	mm in.	mm in.	N lbf			N lbf	N lbf		N lbf				
69.850 2.7500	149.225 5.8750	53.975 2.1250	411000 92400	0.36	1.66	107000 24000	66000 14800	1.61	463000 104000		6454	6420	
69.850 2.7500	149.225 5.8750	53.975 2.1250	411000 92400	0.36	1.66	107000 24000	66000 14800	1.61	463000 104000		6484	6420	
69.850 2.7500	150.089 5.9090	44.450 1.7500	377000 84700	0.33	1.84	97600 21900	54400 12200	1.80	417000 93800		745A	742	
69.850 2.7500	150.089 5.9090	44.450 1.7500	318000 71400	0.33	1.84	82400 18500	45900 10300	1.80	417000 93800		744A	742	
69.850 2.7500	152.400 6.0000	41.275 1.6250	247000 55500	0.41	1.47	64000 14400	44800 10100	1.43	335000 75300		655	652	
69.850 2.7500	168.275 6.6250	53.975 2.1250	485000 109000	0.30	2.00	126000 28300	64400 14500	1.95	522000 117000		835	832	
69.914 2.7525	171.450 6.7500	49.212 1.9375	363000 81600	0.76	0.79	94100 21200	123000 27700	0.76	351000 78800		9382	9321	
69.952 2.7540	121.442 4.7812	24.608 0.9688	102000 23000	0.45	1.33	26500 5960	20500 4600	1.30	136000 30600		34274	34478	
69.987 2.7554	136.525 5.3750	46.038 1.8125	319000 71700	0.47	1.27	82700 18600	67000 15100	1.24	405000 91000		H715347	H715311	
69.987 2.7554	176.212 6.9375	54.770 2.1563	366000 82200	0.70	0.86	94800 21300	114000 25500	0.84	431000 96900		H916642	H916610	
70.000 2.7559	110.000 4.3307	21.000 0.8268	91600 20600	0.46	1.30	23700 5340	18700 4210	1.27	112000 25200		JP7049	JP7010	
70.000 2.7559	110.000 4.3307	26.000 1.0236	115000 25700	0.49	1.23	29700 6680	24800 5570	1.20	168000 37800		JLM813049	JLM813010	
70.000 2.7559	115.000 4.5276	29.000 1.1417	178000 40000	0.43	1.39	46100 10400	33900 7630	1.36	198000 44500		JM612949	JM612910	
70.000 2.7559	120.000 4.7244	29.002 1.1418	143000 32200	0.38	1.56	37200 8360	24500 5500	1.52	186000 41900		484	472A	
70.000 2.7559	121.442 4.7812	24.608 0.9688	102000 23000	0.45	1.33	26500 5960	20500 4600	1.30	136000 30600		34275	34478	
70.000 2.7559	123.825 4.8750	30.162 1.1875	143000 32200	0.38	1.56	37200 8360	24500 5500	1.52	186000 41900		484	472X	
70.000 2.7559	125.095 4.9250	24.000 0.9449	102000 23000	0.45	1.33	26500 5960	20500 4600	1.30	136000 30600		34275	34492	

⁽¹⁾Based on 1 x 10⁶ revolutions L₁₀ life, for the ISO life-calculation method.

⁽²⁾Consult your Timken engineer for instructions on use or review the Timken Engineering Manual on timken.com/catalogs.

⁽³⁾Based on 90 x 10⁶ revolutions L₁₀ life, for The Timken Company life-calculation method. C₉₀ and C_{a90} are radial and thrust values.

Bearing Dimensions											Geometry Factors			Bearing Weight
Width B	Width C	Eff. Ctr. a ⁽⁴⁾	Shaft			Housing			Cage		G ₁	G ₂	C _g	
			Max Shaft Fillet Radius R ⁽⁵⁾	Backing Shoulder Dia. d _a	Shoulder Dia. d _b	Max Housing Fillet Radius r ⁽⁵⁾	Backing Shoulder Dia. D _a	Shoulder Dia. D _b	A _a ⁽⁶⁾	A _b ⁽⁷⁾				
mm in.	mm in.	mm in.	mm in.	mm in.	mm in.	mm in.	mm in.	mm in.	mm in.	mm in.				kg lbs.
54.229 2.1350	44.450 1.7500	-15.0 -0.59	5.0 0.20	85.0 3.35	94.0 3.70	3.3 0.13	140.0 5.51	129.0 5.08	2.7 0.10	0.7 0.03	158.3	29.1	0.0931	4.54 10.01
54.229 2.1350	44.450 1.7500	-15.0 -0.59	6.4 0.25	85.0 3.35	97.0 3.82	3.3 0.13	140.0 5.51	129.0 5.08	2.7 0.10	0.7 0.03	158.3	29.1	0.0931	4.53 9.99
46.672 1.8375	36.512 1.4375	-11.9 -0.47	3.5 0.14	82.0 3.23	88.0 3.46	3.3 0.13	142.0 5.59	134.0 5.28	1.8 0.07	1.3 0.05	159.6	26.3	0.0898	3.93 8.64
46.672 1.8375	36.512 1.4375	-11.9 -0.47	5.0 0.20	82.0 3.23	91.0 3.58	3.3 0.13	142.0 5.59	134.0 5.28	1.8 0.07	1.3 0.05	159.6	26.3	0.0898	3.91 8.60
41.275 1.6250	31.750 1.2500	-7.9 -0.31	3.5 0.14	82.0 3.23	88.0 3.46	3.3 0.13	141.0 5.55	134.0 5.28	4.5 0.17	2.1 0.08	136.6	27.3	0.0919	3.59 7.94
56.363 2.2190	41.275 1.6250	-18.5 -0.73	3.5 0.14	84.0 3.31	91.0 3.58	3.3 0.13	155.0 6.10	149.0 5.87	5.2 0.20	1.6 0.07	197.9	34.8	0.0937	6.10 13.43
46.038 1.8125	31.750 1.2500	4.3 0.17	3.5 0.14	95.0 3.74	101.0 3.98	3.3 0.13	164.0 6.46	147.0 5.79	8.9 0.35	3.9 0.16	117.9	18.6	0.1053	5.37 11.83
23.012 0.9060	17.462 0.6875	1.5 0.06	2.0 0.08	78.0 3.07	81.0 3.19	2.0 0.08	116.0 4.57	110.0 4.33	2.6 0.10	2.1 0.09	69.3	27.0	0.1093	1.08 2.39
46.038 1.8125	36.512 1.4375	-8.6 -0.34	3.5 0.14	87.0 3.43	93.0 3.66	3.3 0.13	132.0 5.20	118.0 4.65	4.1 0.16	2.0 0.08	147.1	33.5	0.0993	3.17 6.98
53.183 2.0938	36.512 1.4375	-2.0 -0.08	3.3 0.13	95.0 3.74	103.0 4.06	3.3 0.13	164.0 6.46	147.0 5.79	8.6 0.34	3.4 0.14	132.9	18.7	0.1071	6.31 13.93
20.000 0.7874	15.500 0.6102	2.5 0.10	2.0 0.08	76.0 2.99	80.0 3.15	2.0 0.08	105.4 4.15	101.0 3.98	1.5 0.05	2.9 0.12	51.1	31.0	0.9950	0.67 1.49
25.000 0.9843	20.500 0.8071	0.3 0.01	1.0 0.04	77.0 3.03	78.0 3.07	2.5 0.10	105.0 4.13	98.0 3.86	1.7 0.06	2.8 0.11	73.5	26.3	0.1151	0.88 1.93
29.000 1.1417	23.000 0.9055	-2.5 -0.10	3.0 0.12	77.0 3.03	83.0 3.27	2.5 0.10	110.0 4.33	103.0 4.06	1.0 0.04	2.3 0.09	76.7	25.7	0.1122	1.12 2.49
29.007 1.1420	23.444 0.9230	-4.1 -0.16	2.0 0.08	77.0 3.03	80.0 3.15	3.3 0.13	114.0 4.49	106.0 4.17	1.5 0.05	2.2 0.09	77.2	23.0	0.1083	1.29 2.82
23.012 0.9060	17.462 0.6875	1.5 0.06	2.0 0.08	78.0 3.07	82.0 3.23	2.0 0.08	116.0 4.57	110.0 4.33	2.6 0.10	2.1 0.09	69.3	27.0	0.1093	1.08 2.39
29.007 1.1420	24.605 0.9687	-4.1 -0.16	2.0 0.08	77.0 3.03	80.0 3.15	3.3 0.13	115.0 4.53	109.0 4.29	1.5 0.05	2.2 0.09	77.2	23.0	0.1083	1.46 3.20
23.012 0.9060	16.670 0.6563	1.5 0.06	2.0 0.08	78.0 3.07	82.0 3.23	2.0 0.08	118.0 4.65	112.0 4.41	2.6 0.10	2.1 0.09	69.3	27.0	0.1093	1.16 2.55

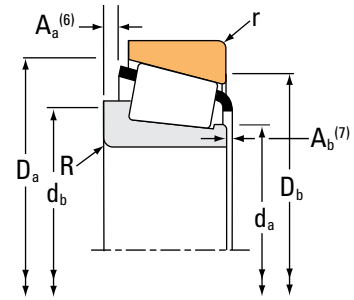
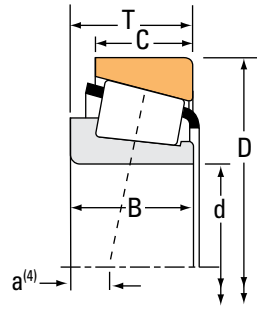
⁽⁴⁾Negative value indicates effective center inside cone (inner-ring) backface.
⁽⁵⁾These maximum fillet radii will be cleared by the bearing corners.
⁽⁶⁾Negative value indicates cage extends beyond cone (inner-ring) backface.
⁽⁷⁾Negative value indicates cage that does not extend beyond cone (inner-ring) front face.

Continued on next page.

TAPERED ROLLER BEARINGS

SINGLE-ROW • TYPE TS

TYPE TS



Bearing Dimensions			Load Ratings							Part Number			
Bore d	O.D. D	Width T	Dynamic ⁽¹⁾		Factors ⁽²⁾		Dynamic ⁽³⁾		Factors ⁽²⁾		Static C ₀	Inner	Outer
			C ₁	e	Y	C ₉₀	C _{a90}	K	N	N			
mm in.	mm in.	mm in.	N lbf			N lbf	N lbf		N lbf				
70.000 2.7559	130.000 5.1181	36.937 1.4542	196000 44100	0.36	1.65	50900 11400	31700 7130	1.61	262000 58900		570X	562X	
70.000 2.7559	130.000 5.1181	43.000 1.6929	325000 73200	0.33	1.80	84400 19000	48100 10800	1.75	360000 80800		JF7049A	JF7010	
70.000 2.7559	130.000 5.1181	43.000 1.6929	325000 73200	0.33	1.80	84400 19000	48100 10800	1.75	360000 80800		JF7049	JF7010	
70.000 2.7559	140.000 5.5118	39.000 1.5354	241000 54200	0.87	0.69	62600 14100	92800 20900	0.67	257000 57800		JW7049	JW7010	
70.000 2.7559	149.225 5.8750	53.975 2.1250	411000 92400	0.36	1.66	107000 24000	66000 14800	1.61	463000 104000		6459	6420	
70.000 2.7559	150.000 5.9055	54.000 2.1260	411000 92400	0.36	1.66	107000 24000	66000 14800	1.61	463000 104000		6459	6424	
70.637 2.7810	112.712 4.4375	25.400 1.0000	111000 24800	0.49	1.23	28600 6440	23900 5370	1.20	166000 37200		29680	29620	
70.637 2.7810	112.712 4.4375	25.400 1.0000	111000 24800	0.49	1.23	28600 6440	23900 5370	1.20	166000 37200		29681	29620	
71.437 2.8125	117.475 4.6250	30.162 1.1875	138000 31100	0.44	1.38	35900 8060	26800 6020	1.34	197000 44300		33281	33462	
71.437 2.8125	117.475 4.6250	30.162 1.1875	138000 31100	0.44	1.38	35900 8060	26800 6020	1.34	197000 44300		33281	33461	
71.437 2.8125	120.000 4.7244	29.794 1.1730	138000 31100	0.44	1.38	35900 8060	26800 6020	1.34	197000 44300		33281	33472	
71.437 2.8125	120.000 4.7244	32.545 1.2813	179000 40200	0.36	1.67	46300 10400	28600 6420	1.62	249000 56000		47490	47420	
71.437 2.8125	120.650 4.7500	32.545 1.2813	179000 40200	0.36	1.67	46300 10400	28600 6420	1.62	249000 56000		47490	47423	
71.437 2.8125	127.000 5.0000	36.512 1.4375	196000 44100	0.36	1.65	50900 11400	31700 7130	1.61	262000 58900		567A	563	
71.437 2.8125	127.000 5.0000	36.512 1.4375	196000 44100	0.36	1.65	50900 11400	31700 7130	1.61	262000 58900		567-S	563	
71.437 2.8125	127.000 5.0000	36.512 1.4375	229000 51500	0.50	1.20	59400 13400	51100 11500	1.16	256000 57600		HM813849	HM813810	
71.437 2.8125	127.000 5.0000	36.512 1.4375	229000 51500	0.50	1.20	59400 13400	51100 11500	1.16	256000 57600		HM813849	HM813811	

⁽¹⁾Based on 1 x 10⁶ revolutions L₁₀ life, for the ISO life-calculation method.

⁽²⁾Consult your Timken engineer for instructions on use or review the Timken Engineering Manual on timken.com/catalogs.

⁽³⁾Based on 90 x 10⁶ revolutions L₁₀ life, for The Timken Company life-calculation method. C₉₀ and C_{a90} are radial and thrust values.

Bearing Dimensions											Geometry Factors			Bearing Weight
Width B	Width C	Eff. Ctr. a ⁽⁴⁾	Shaft			Housing			Cage		G ₁	G ₂	C _g	
			Max Shaft Fillet Radius R ⁽⁵⁾	Backing Shoulder Dia. d _a d _b		Max Housing Fillet Radius r ⁽⁵⁾	Backing Shoulder Dia. D _a D _b		A _a ⁽⁶⁾	A _b ⁽⁷⁾				
mm in.	mm in.	mm in.	mm in.	mm in.	mm in.	mm in.	mm in.	mm in.	mm in.	mm in.				kg lbs.
36.170 1.4240	29.000 1.1417	-8.1 -0.32	3.0 0.12	78.0 3.07	84.0 3.31	3.0 0.12	121.0 4.76	114.0 4.49	3.2 0.12	1.8 0.08	101.3	24.0	0.1167	2.05 4.51
42.000 1.6535	35.000 1.3780	-12.4 -0.49	7.0 0.28	81.0 3.17	94.0 3.70	2.5 0.10	124.0 4.88	116.0 4.57	2.0 0.08	4.0 0.16	120.7	24.5	0.0828	2.46 5.40
42.000 1.6535	35.000 1.3780	-12.4 -0.49	3.0 0.12	81.0 3.17	86.0 3.39	2.5 0.10	124.0 4.88	116.0 4.57	2.0 0.08	4.0 0.16	120.7	24.5	0.8280	2.49 5.49
35.500 1.3976	27.000 1.0630	8.6 0.34	3.0 0.12	82.0 3.23	95.0 3.74	3.0 0.12	133.0 5.25	117.0 4.61	5.8 0.22	4.5 0.18	85.2	23.4	0.0984	2.64 5.79
54.229 2.1350	44.450 1.7500	-15.0 -0.59	3.0 0.12	85.0 3.35	90.0 3.54	3.3 0.13	140.0 5.51	129.0 5.08	2.7 0.10	0.7 0.03	158.3	29.1	0.0931	4.55 10.03
54.229 2.1350	45.000 1.7717	-15.0 -0.59	3.0 0.12	85.0 3.35	90.0 3.54	3.0 0.12	140.0 5.51	129.0 5.08	2.7 0.10	0.7 0.03	158.3	29.1	0.0931	4.63 10.21
25.400 1.0000	19.050 0.7500	1.0 0.04	1.3 0.05	78.0 3.07	80.0 3.15	3.3 0.13	109.0 4.29	101.0 3.98	2.3 0.09	1.5 0.06	77.7	43.3	0.1170	0.93 2.07
25.400 1.0000	19.050 0.7500	1.0 0.04	3.5 0.14	78.0 3.07	85.0 3.35	3.3 0.13	109.0 4.29	101.0 3.98	2.3 0.09	1.5 0.06	77.7	43.3	0.1170	0.93 2.06
30.162 1.1875	23.812 0.9375	-2.8 -0.11	3.5 0.14	80.0 3.15	87.0 3.43	3.3 0.13	112.0 4.41	104.0 4.09	2.2 0.08	1.1 0.05	84.2	25.9	0.1162	1.22 2.68
30.162 1.1875	23.812 0.9375	-2.8 -0.11	3.5 0.14	80.0 3.15	87.0 3.43	0.8 0.03	112.0 4.41	106.0 4.17	2.2 0.08	1.1 0.05	84.2	25.9	0.1162	1.23 2.71
30.162 1.1875	23.444 0.9230	-2.8 -0.11	3.5 0.14	80.0 3.15	87.0 3.43	0.8 0.03	113.0 4.45	107.0 4.21	2.2 0.08	1.1 0.05	84.2	25.9	0.1162	1.31 2.88
32.545 1.2813	26.195 1.0313	-6.4 -0.25	3.5 0.14	79.0 3.11	86.0 3.39	3.3 0.13	114.0 4.49	107.0 4.21	2.2 0.08	2.0 0.08	98.4	26.3	0.1153	1.41 3.10
32.545 1.2813	26.195 1.0313	-6.4 -0.25	3.5 0.14	79.0 3.11	86.0 3.39	0.8 0.03	115.0 4.53	109.0 4.29	2.2 0.08	2.0 0.08	98.4	26.3	0.1153	1.45 3.19
36.170 1.4240	28.575 1.1250	-8.1 -0.32	3.5 0.14	80.0 3.15	86.0 3.39	3.3 0.13	120.0 4.72	112.0 4.41	3.2 0.12	1.8 0.08	101.3	24.0	0.1167	1.85 4.09
36.170 1.4240	28.575 1.1250	-8.1 -0.32	6.4 0.25	80.0 3.15	92.0 3.62	3.3 0.13	120.0 4.72	112.0 4.41	3.2 0.12	1.8 0.08	101.3	24.0	0.1167	1.82 4.03
36.512 1.4375	26.988 1.0625	-3.8 -0.15	3.5 0.14	82.0 3.23	91.0 3.58	3.3 0.13	121.0 4.76	111.0 4.37	4.0 0.15	1.3 0.06	91.7	22.9	0.1252	1.84 4.08
36.512 1.4375	26.988 1.0625	-3.8 -0.15	3.5 0.14	82.0 3.23	91.0 3.58	1.5 0.06	121.0 4.76	113.0 4.45	4.0 0.15	1.3 0.06	91.7	22.9	0.1252	1.84 4.08

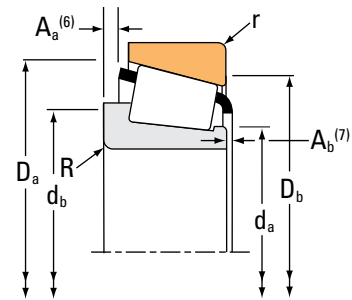
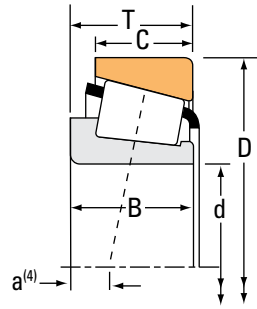
⁽⁴⁾Negative value indicates effective center inside cone (inner-ring) backface.
⁽⁵⁾These maximum fillet radii will be cleared by the bearing corners.
⁽⁶⁾Negative value indicates cage extends beyond cone (inner-ring) backface.
⁽⁷⁾Negative value indicates cage that does not extend beyond cone (inner-ring) front face.

Continued on next page.

TAPERED ROLLER BEARINGS

SINGLE-ROW • TYPE TS

TYPE TS



Bearing Dimensions			Load Ratings							Part Number			
Bore d	O.D. D	Width T	Dynamic ⁽¹⁾		Factors ⁽²⁾		Dynamic ⁽³⁾		Factors ⁽²⁾		Static C ₀	Inner	Outer
			C ₁	e	Y	C ₉₀	C _{a90}	K	N	N			
mm in.	mm in.	mm in.	N lbf			N lbf	N lbf		N lbf				
71.437 2.8125	130.175 5.1250	41.275 1.6250	276000 62100	0.36	1.66	71600 16100	44400 9980	1.61	298000 67000		645	633	
71.437 2.8125	130.175 5.1250	41.275 1.6250	276000 62100	0.36	1.66	71600 16100	44400 9980	1.61	298000 67000		644	633	
71.437 2.8125	133.350 5.2500	33.338 1.3125	214000 48100	0.40	1.48	55500 12500	38400 8640	1.44	262000 58900		47675	47620	
71.437 2.8125	136.525 5.3750	30.162 1.1875	154000 34700	0.44	1.35	40000 9000	30500 6850	1.31	216000 48600		495-S	493	
71.437 2.8125	136.525 5.3750	41.275 1.6250	276000 62100	0.36	1.66	71600 16100	44400 9980	1.61	298000 67000		645	632	
71.437 2.8125	136.525 5.3750	41.275 1.6250	276000 62100	0.36	1.66	71600 16100	44400 9980	1.61	298000 67000		644	632	
71.437 2.8125	136.525 5.3750	41.275 1.6250	233000 52400	0.36	1.66	60400 13600	37400 8420	1.61	298000 67000		645X	632	
71.437 2.8125	136.525 5.3750	41.275 1.6250	323000 72600	0.36	1.67	83700 18800	51600 11600	1.62	335000 75400		H414249	H414210	
71.437 2.8125	136.525 5.3750	46.038 1.8125	319000 71700	0.47	1.27	82700 18600	67000 15100	1.24	405000 91000		H715345	H715311	
71.437 2.8125	139.700 5.5000	46.038 1.8125	319000 71700	0.47	1.27	82700 18600	67000 15100	1.24	405000 91000		H715345	H715310	
73.025 2.8750	112.712 4.4375	25.400 1.0000	111000 24800	0.49	1.23	28600 6440	23900 5370	1.20	166000 37200		29685	29620	
73.025 2.8750	117.475 4.6250	25.400 1.0000	118000 26500	0.51	1.18	30600 6870	26700 5990	1.15	183000 41200		LM814845	LM814810	
73.025 2.8750	117.475 4.6250	30.162 1.1875	138000 31100	0.44	1.38	35900 8060	26800 6020	1.34	197000 44300		33287	33462	
73.025 2.8750	120.000 4.7244	29.794 1.1730	138000 31100	0.44	1.38	35900 8060	26800 6020	1.34	197000 44300		33287	33472	
73.025 2.8750	120.000 4.7244	29.794 1.1730	138000 31100	0.44	1.38	35900 8060	26800 6020	1.34	197000 44300		33287A	33472	
73.025 2.8750	125.412 4.9375	25.400 1.0000	117000 26300	0.42	1.44	30400 6830	21600 4860	1.40	178000 39900		27680	27620	
73.025 2.8750	127.000 5.0000	30.162 1.1875	161000 36200	0.42	1.43	41800 9390	29900 6730	1.39	222000 49800		42683	42620	

⁽¹⁾Based on 1 x 10⁶ revolutions L₁₀ life, for the ISO life-calculation method.

⁽²⁾Consult your Timken engineer for instructions on use or review the Timken Engineering Manual on timken.com/catalogs.

⁽³⁾Based on 90 x 10⁶ revolutions L₁₀ life, for The Timken Company life-calculation method. C₉₀ and C_{a90} are radial and thrust values.

Bearing Dimensions											Geometry Factors			Bearing Weight
Width B	Width C	Eff. Ctr. a ⁽⁴⁾	Shaft			Housing			Cage		G ₁	G ₂	C _g	
			Max Shaft Fillet Radius R ⁽⁵⁾	Backing Shoulder Dia. d _a	Shoulder Dia. d _b	Max Housing Fillet Radius r ⁽⁵⁾	Backing Shoulder Dia. D _a	Shoulder Dia. D _b	A _a ⁽⁶⁾	A _b ⁽⁷⁾				
mm in.	mm in.	mm in.	mm in.	mm in.	mm in.	mm in.	mm in.	mm in.	mm in.	mm in.				kg lbs.
41.275 1.6250	31.750 1.2500	-11.2 -0.44	6.4 0.25	81.0 3.19	93.0 3.66	3.3 0.13	124.0 4.88	116.0 4.57	4.1 0.16	2.0 0.08	106.4	21.0	0.0814	2.19 4.81
41.275 1.6250	31.750 1.2500	-11.2 -0.44	3.5 0.14	81.0 3.19	87.0 3.43	3.3 0.13	124.0 4.88	116.0 4.57	4.1 0.16	2.0 0.08	106.4	21.0	0.0814	2.22 4.89
33.338 1.3125	26.195 1.0313	-4.3 -0.17	3.5 0.14	82.0 3.23	88.0 3.46	3.3 0.13	128.0 5.04	119.0 4.69	2.3 0.09	2.4 0.10	119.4	29.2	0.1273	2.06 4.52
29.769 1.1720	22.225 0.8750	-0.8 -0.03	3.5 0.14	82.0 3.23	88.0 3.46	3.3 0.13	130.0 5.12	122.0 4.80	2.5 0.09	2.2 0.09	104.6	29.3	0.1252	1.93 4.25
41.275 1.6250	31.750 1.2500	-11.2 -0.44	6.4 0.25	81.0 3.19	93.0 3.66	3.3 0.13	125.0 4.92	118.0 4.65	4.1 0.16	2.0 0.08	106.4	21.0	0.0814	2.53 5.57
41.275 1.6250	31.750 1.2500	-11.2 -0.44	3.5 0.14	81.0 3.19	87.0 3.43	3.3 0.13	125.0 4.92	118.0 4.65	4.1 0.16	2.0 0.08	106.4	21.0	0.0814	2.56 5.65
41.275 1.6250	31.750 1.2500	-11.2 -0.44	6.4 0.25	82.7 3.25	93.0 3.66	3.3 0.13	125.0 4.92	118.0 4.65	4.1 0.16	2.0 0.08	106.4	21.0	0.0814	2.52 5.56
41.275 1.6250	31.750 1.2500	-10.9 -0.43	3.5 0.14	83.3 3.27	89.0 3.50	3.3 0.13	129.0 5.08	121.0 4.76	3.7 0.14	3.1 0.12	112.8	22.9	0.0827	2.54 5.62
46.038 1.8125	36.512 1.4375	-8.6 -0.34	3.5 0.14	88.0 3.46	94.0 3.70	3.3 0.13	132.0 5.20	118.0 4.65	4.1 0.16	2.0 0.08	147.1	33.5	0.0993	3.11 6.86
46.038 1.8125	36.512 1.4375	-8.6 -0.34	3.5 0.14	88.0 3.46	94.0 3.70	3.3 0.13	133.0 5.24	120.0 4.72	4.1 0.16	2.0 0.08	147.1	33.5	0.0993	3.29 7.26
25.400 1.0000	19.050 0.7500	1.0 0.04	3.5 0.14	80.0 3.15	86.0 3.39	3.3 0.13	109.0 4.29	101.0 3.98	2.3 0.09	1.5 0.06	77.7	43.3	0.1170	0.88 1.95
25.400 1.0000	19.050 0.7500	2.3 0.09	3.5 0.14	81.0 3.19	87.0 3.43	3.3 0.13	113.0 4.45	105.0 4.13	2.4 0.09	1.5 0.06	88.6	36.6	0.1239	1.02 2.25
30.162 1.1875	23.812 0.9375	-2.8 -0.11	3.5 0.14	81.0 3.19	88.0 3.46	3.3 0.13	112.0 4.41	104.0 4.09	2.2 0.08	1.1 0.05	84.2	25.9	0.1162	1.18 2.59
30.162 1.1875	23.444 0.9230	-2.8 -0.11	3.5 0.14	81.0 3.19	88.0 3.46	0.8 0.03	113.0 4.45	107.0 4.21	2.2 0.08	1.1 0.05	84.2	25.9	0.1162	1.27 2.79
30.162 1.1875	23.444 0.9230	-2.8 -0.11	0.3 0.01	81.0 3.19	82.0 3.23	0.8 0.03	113.0 4.45	107.0 4.21	2.2 0.08	1.1 0.05	84.2	25.9	0.1162	1.27 2.80
25.400 1.0000	19.845 0.7813	0.5 0.02	3.5 0.14	82.0 3.23	88.0 3.46	1.5 0.06	120.0 4.72	115.0 4.53	1.5 0.06	1.7 0.07	98.2	41.8	0.1198	1.29 2.85
31.000 1.2205	22.225 0.8750	-2.8 -0.11	3.5 0.14	81.0 3.19	88.0 3.46	3.3 0.13	121.0 4.76	114.0 4.49	3.3 0.13	0.9 0.04	96.2	28.6	0.1197	1.51 3.31

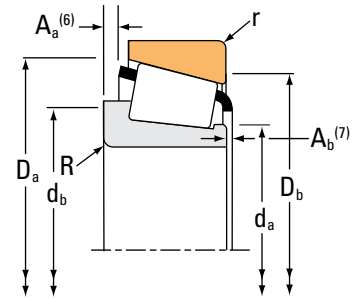
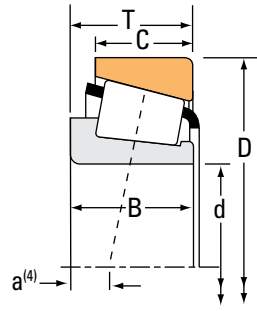
(4) Negative value indicates effective center inside cone (inner-ring) backface.
 (5) These maximum fillet radii will be cleared by the bearing corners.
 (6) Negative value indicates cage extends beyond cone (inner-ring) backface.
 (7) Negative value indicates cage that does not extend beyond cone (inner-ring) front face.

Continued on next page.

TAPERED ROLLER BEARINGS

SINGLE-ROW • TYPE TS

TYPE TS



Bearing Dimensions			Load Ratings							Part Number			
Bore d	O.D. D	Width T	Dynamic ⁽¹⁾		Factors ⁽²⁾		Dynamic ⁽³⁾		Factors ⁽²⁾		Static C ₀	Inner	Outer
			C ₁	e	Y	C ₉₀	C _{a90}	K	N	N			
mm in.	mm in.	mm in.	N lbf			N lbf	N lbf		N lbf				
73.025 2.8750	127.000 5.0000	36.512 1.4375	196000 44100	0.36	1.65	50900 11400	31700 7130	1.61	262000 58900			567	563
73.025 2.8750	127.000 5.0000	36.512 1.4375	196000 44100	0.36	1.65	50900 11400	31700 7130	1.61	262000 58900			567X	563
73.025 2.8750	127.000 5.0000	36.512 1.4375	196000 44100	0.36	1.65	50900 11400	31700 7130	1.61	262000 58900			567	563X
73.025 2.8750	127.000 5.0000	36.512 1.4375	196000 44100	0.36	1.65	50900 11400	31700 7130	1.61	262000 58900			567X	563X
73.025 2.8750	130.000 5.1181	36.937 1.4542	196000 44100	0.36	1.65	50900 11400	31700 7130	1.61	262000 58900			567X	562X
73.025 2.8750	130.048 5.1200	36.512 1.4375	196000 44100	0.36	1.65	50900 11400	31700 7130	1.61	262000 58900			567	562
73.025 2.8750	139.992 5.5115	36.512 1.4375	207000 46500	0.40	1.49	53600 12100	37100 8330	1.45	291000 65400			576	572
73.025 2.8750	146.050 5.7500	41.275 1.6250	247000 55500	0.41	1.47	64000 14400	44800 10100	1.43	335000 75300			657	653
73.025 2.8750	149.225 5.8750	53.975 2.1250	411000 92400	0.36	1.66	107000 24000	66000 14800	1.61	463000 104000			6460	6420
73.025 2.8750	149.225 5.8750	53.975 2.1250	411000 92400	0.36	1.66	107000 24000	66000 14800	1.61	463000 104000			6460	6420A
73.025 2.8750	150.089 5.9090	44.450 1.7500	377000 84700	0.33	1.84	97600 21900	54400 12200	1.80	417000 93800			744	742
73.025 2.8750	152.400 6.0000	41.275 1.6250	247000 55500	0.41	1.47	64000 14400	44800 10100	1.43	335000 75300			657	652
73.817 2.9062	112.712 4.4375	25.400 1.0000	111000 24800	0.49	1.23	28600 6440	23900 5370	1.20	166000 37200			29688	29620
73.817 2.9062	127.000 5.0000	36.512 1.4375	196000 44100	0.36	1.65	50900 11400	31700 7130	1.61	262000 58900			568	563
74.612 2.9375	139.992 5.5115	36.512 1.4375	207000 46500	0.40	1.49	53600 12100	37100 8330	1.45	291000 65400			577	572
74.612 2.9375	152.400 6.0000	41.275 1.6250	247000 55500	0.41	1.47	64000 14400	44800 10100	1.43	335000 75300			658	652
74.976 2.9518	127.000 5.0000	26.988 1.0625	102000 23000	0.45	1.33	26500 5960	20500 4600	1.30	136000 30600			34294	34500

⁽¹⁾Based on 1 x 10⁶ revolutions L₁₀ life, for the ISO life-calculation method.

⁽²⁾Consult your Timken engineer for instructions on use or review the Timken Engineering Manual on timken.com/catalogs.

⁽³⁾Based on 90 x 10⁶ revolutions L₁₀ life, for The Timken Company life-calculation method. C₉₀ and C_{a90} are radial and thrust values.

Bearing Dimensions											Geometry Factors			Bearing Weight
Width B	Width C	Eff. Ctr. a ⁽⁴⁾	Shaft			Housing			Cage		G ₁	G ₂	C _g	
			Max Shaft Fillet Radius R ⁽⁵⁾	Backing Shoulder Dia. d _a	Shoulder Dia. d _b	Max Housing Fillet Radius r ⁽⁵⁾	Backing Shoulder Dia. D _a	Shoulder Dia. D _b	A _a ⁽⁶⁾	A _b ⁽⁷⁾				
mm in.	mm in.	mm in.	mm in.	mm in.	mm in.	mm in.	mm in.	mm in.	mm in.	mm in.				kg lbs.
36.170 1.4240	28.575 1.1250	-8.1 -0.32	3.5 0.14	81.0 3.19	88.0 3.46	3.3 0.13	120.0 4.72	112.0 4.41	3.2 0.12	1.8 0.08	101.3	24.0	0.1167	1.80 3.98
36.170 1.4240	28.575 1.1250	-8.1 -0.32	4.8 0.19	81.0 3.19	90.0 3.54	3.3 0.13	120.0 4.72	112.0 4.41	3.2 0.12	1.8 0.08	101.3	24.0	0.1167	1.80 3.99
36.170 1.4240	28.575 1.1250	-8.1 -0.32	3.5 0.14	81.0 3.19	88.0 3.46	0.8 0.03	120.0 4.72	114.0 4.49	3.2 0.12	1.8 0.08	101.3	24.0	0.1167	1.81 3.99
36.170 1.4240	28.575 1.1250	-8.1 -0.32	4.8 0.19	81.0 3.19	90.0 3.54	0.8 0.03	120.0 4.72	114.0 4.49	3.2 0.12	1.8 0.08	101.3	24.0	0.1167	1.81 4.00
36.170 1.4240	29.000 1.1417	-8.1 -0.32	4.8 0.19	81.0 3.19	90.0 3.54	3.0 0.12	121.0 4.76	114.0 4.49	3.2 0.12	1.8 0.08	101.3	24.0	0.1167	1.95 4.30
36.170 1.4240	28.575 1.1250	-8.1 -0.32	3.5 0.14	81.0 3.19	88.0 3.46	0.8 0.03	121.0 4.76	116.0 4.57	3.2 0.12	1.8 0.08	101.3	24.0	0.1167	1.95 4.29
36.098 1.4212	28.575 1.1250	-5.3 -0.21	3.5 0.14	83.0 3.27	90.0 3.54	3.3 0.13	133.0 5.24	125.0 4.92	3.4 0.13	1.9 0.08	125.7	32.0	0.1295	2.46 5.43
41.275 1.6250	31.750 1.2500	-7.9 -0.31	3.5 0.14	85.0 3.35	91.0 3.58	3.3 0.13	139.0 5.47	131.0 5.16	4.5 0.17	2.1 0.08	136.6	27.3	0.0919	3.13 6.89
54.229 2.1350	44.450 1.7500	-15.0 -0.59	3.5 0.14	87.0 3.43	93.0 3.66	3.3 0.13	140.0 5.51	129.0 5.08	2.7 0.10	0.7 0.03	158.3	29.1	0.0931	4.40 9.71
54.229 2.1350	44.450 1.7500	-15.0 -0.59	3.5 0.14	87.0 3.43	93.0 3.66	0.8 0.03	140.0 5.51	131.0 5.16	2.7 0.10	0.7 0.03	158.3	29.1	0.0931	4.42 9.75
46.672 1.8375	36.512 1.4375	-11.9 -0.47	3.5 0.14	85.0 3.35	91.0 3.58	3.3 0.13	142.0 5.59	134.0 5.28	1.8 0.07	1.3 0.05	159.6	26.3	0.0898	3.79 8.34
41.275 1.6250	31.750 1.2500	-7.9 -0.31	3.5 0.14	85.0 3.35	91.0 3.58	3.3 0.13	141.0 5.55	134.0 5.28	4.5 0.17	2.1 0.08	136.6	27.3	0.0919	3.48 7.68
25.400 1.0000	19.050 0.7500	1.0 0.04	1.5 0.06	80.0 3.15	83.0 3.27	3.3 0.13	109.0 4.29	101.0 3.98	2.3 0.09	1.5 0.06	77.7	43.3	0.1170	0.86 1.91
36.170 1.4240	28.575 1.1250	-8.1 -0.32	0.8 0.03	82.0 3.23	83.0 3.27	3.3 0.13	120.0 4.72	112.0 4.41	3.2 0.12	1.8 0.08	101.3	24.0	0.1167	1.78 3.95
36.098 1.4212	28.575 1.1250	-5.3 -0.21	3.5 0.14	85.0 3.35	91.0 3.58	3.3 0.13	133.0 5.24	125.0 4.92	3.4 0.13	1.9 0.08	125.7	32.0	0.1295	2.41 5.32
41.275 1.6250	31.750 1.2500	-7.9 -0.31	3.5 0.14	86.0 3.39	92.0 3.62	3.3 0.13	141.0 5.55	134.0 5.28	4.5 0.17	2.1 0.08	136.6	27.3	0.0919	3.42 7.55
23.012 0.9060	19.842 0.7812	1.5 0.06	2.0 0.08	82.0 3.23	85.0 3.35	3.3 0.13	118.0 4.65	112.0 4.41	2.6 0.10	2.1 0.09	69.3	27.0	0.1093	1.19 2.64

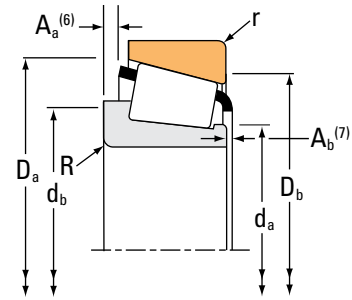
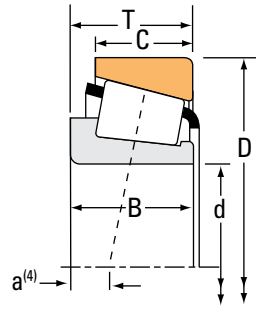
⁽⁴⁾Negative value indicates effective center inside cone (inner-ring) backface.
⁽⁵⁾These maximum fillet radii will be cleared by the bearing corners.
⁽⁶⁾Negative value indicates cage extends beyond cone (inner-ring) backface.
⁽⁷⁾Negative value indicates cage that does not extend beyond cone (inner-ring) front face.

Continued on next page.

TAPERED ROLLER BEARINGS

SINGLE-ROW • TYPE TS

TYPE TS



Bearing Dimensions			Load Ratings							Part Number			
Bore d	O.D. D	Width T	Dynamic ⁽¹⁾		Factors ⁽²⁾		Dynamic ⁽³⁾		Factors ⁽²⁾		Static C ₀	Inner	Outer
			C ₁	e	Y	C ₉₀	C _{a90}	K	N	N			
mm in.	mm in.	mm in.	N lbf			N lbf	N lbf		N lbf				
74.987 2.9523	129.975 5.1171	33.249 1.3090	161000 36200	0.42	1.43	41800 9390	29900 6730	1.39	222000 49800		42686	42624	
75.000 2.9528	115.000 4.5276	25.000 0.9843	140000 31600	0.46	1.31	36400 8180	28600 6420	1.27	167000 37500		JLM714149	JLM714110	
75.000 2.9528	120.000 4.7244	31.000 1.2205	159000 35800	0.44	1.35	41300 9290	31400 7070	1.31	229000 51500		JM714249	JM714210	
75.000 2.9528	120.000 4.7244	31.000 1.2205	159000 35800	0.44	1.35	41300 9290	31400 7070	1.31	229000 51500		JM714249A	JM714210	
75.000 2.9528	145.000 5.7087	51.000 2.0079	347000 78000	0.36	1.66	89900 20200	55700 12500	1.61	463000 104000		JH415647	JH415610	
75.987 2.9916	131.975 5.1959	39.000 1.5354	240000 53900	0.33	1.80	62200 14000	35400 7960	1.76	324000 72800		HM215249	HM215210	
76.200 3.0000	105.570 4.1563	13.495 0.5313	41000 9210	0.47	1.27	10600 2390	8600 1930	1.24	61000 13700		LL714649	LL714610	
76.200 3.0000	109.538 4.3125	19.050 0.7500	69200 15600	0.50	1.20	17900 4030	15400 3470	1.16	120000 27000		L814749	L814710	
76.200 3.0000	121.442 4.7812	24.608 0.9688	102000 23000	0.45	1.33	26500 5960	20500 4600	1.30	136000 30600		34300	34478	
76.200 3.0000	121.442 4.7812	24.608 0.9688	102000 23000	0.45	1.33	26500 5960	20500 4600	1.30	136000 30600		34301	34478	
76.200 3.0000	125.412 4.9375	25.400 1.0000	117000 26300	0.42	1.44	30400 6830	21600 4860	1.40	178000 39900		27684	27620	
76.200 3.0000	125.412 4.9375	25.400 1.0000	111000 24900	0.42	1.44	28700 6450	20400 4590	1.40	178000 39900		27684A	27620	
76.200 3.0000	127.000 5.0000	26.988 1.0625	102000 23000	0.45	1.33	26500 5960	20500 4600	1.30	136000 30600		34301	34500	
76.200 3.0000	127.000 5.0000	26.988 1.0625	102000 23000	0.45	1.33	26500 5960	20500 4600	1.30	136000 30600		34300	34500	
76.200 3.0000	127.000 5.0000	30.162 1.1875	161000 36200	0.42	1.43	41800 9390	29900 6730	1.39	222000 49800		42687	42620	
76.200 3.0000	127.000 5.0000	30.162 1.1875	161000 36200	0.42	1.43	41800 9390	29900 6730	1.39	222000 49800		42688	42620	
76.200 3.0000	133.350 5.2500	30.162 1.1875	154000 34700	0.44	1.35	40000 9000	30500 6850	1.31	216000 48600		495A	492A	

⁽¹⁾Based on 1 x 10⁶ revolutions L₁₀ life, for the ISO life-calculation method.

⁽²⁾Consult your Timken engineer for instructions on use or review the Timken Engineering Manual on timken.com/catalogs.

⁽³⁾Based on 90 x 10⁶ revolutions L₁₀ life, for The Timken Company life-calculation method. C₉₀ and C_{a90} are radial and thrust values.

Bearing Dimensions											Geometry Factors			Bearing Weight
Width B	Width C	Eff. Ctr. a ⁽⁴⁾	Shaft			Housing			Cage		G ₁	G ₂	C _g	
			Max Shaft Fillet Radius R ⁽⁵⁾	Backing Shoulder Dia. d _a	Backing Shoulder Dia. d _b	Max Housing Fillet Radius r ⁽⁵⁾	Backing Shoulder Dia. D _a	Backing Shoulder Dia. D _b	A _a ⁽⁶⁾	A _b ⁽⁷⁾				
mm in.	mm in.	mm in.	mm in.	mm in.	mm in.	mm in.	mm in.	mm in.	mm in.	mm in.				kg lbs.
31.000 1.2205	27.000 1.0630	-2.8 -0.11	6.4 0.25	83.0 3.27	94.0 3.70	2.3 0.09	123.0 4.84	115.0 4.53	3.3 0.13	0.9 0.04	96.2	28.6	0.1197	1.66 3.66
25.000 0.9843	19.000 0.7480	0.5 0.02	3.0 0.12	82.0 3.23	88.0 3.46	2.5 0.10	110.5 4.35	104.0 4.09	2.0 0.08	2.1 0.09	76.3	33.7	0.1140	0.88 1.93
29.500 1.1614	25.000 0.9843	-2.0 -0.08	3.0 0.12	82.9 3.26	88.0 3.46	2.5 0.10	115.0 4.53	108.0 4.25	2.1 0.08	2.7 0.11	95.0	32.8	0.1218	1.27 2.81
29.500 1.1614	25.000 0.9843	-2.0 -0.08	6.0 0.24	83.0 3.27	94.0 3.70	2.5 0.10	115.0 4.53	108.0 4.25	2.1 0.08	2.7 0.11	95.0	32.8	0.1218	1.23 2.72
51.000 2.0079	42.000 1.6535	-14.2 -0.56	3.0 0.12	89.0 3.50	94.0 3.70	2.5 0.10	139.0 5.47	129.0 5.08	2.0 0.07	3.2 0.13	158.3	26.4	0.0931	3.81 8.42
39.000 1.5354	32.000 1.2598	-9.7 -0.38	7.0 0.28	85.0 3.35	98.0 3.86	3.5 0.14	126.0 4.96	118.0 4.65	1.2 0.04	2.8 0.11	125.7	30.2	0.0837	2.11 4.65
13.495 0.5313	9.525 0.3750	6.6 0.26	1.5 0.06	81.0 3.19	83.0 3.27	1.5 0.06	102.0 4.02	99.0 3.90	0.8 0.03	1.2 0.05	45.7	64.3	0.0956	0.32 0.71
19.050 0.7500	15.083 0.5938	5.1 0.20	1.5 0.06	82.0 3.23	84.0 3.31	1.5 0.06	105.0 4.13	100.0 3.94	0.8 0.03	1.2 0.05	76.0	58.3	0.1164	0.58 1.28
23.012 0.9060	17.462 0.6875	1.5 0.06	2.0 0.08	83.0 3.27	86.0 3.39	2.0 0.08	116.0 4.57	110.0 4.33	2.6 0.10	2.1 0.09	69.3	27.0	0.1093	0.95 2.12
23.012 0.9060	17.462 0.6875	1.5 0.06	3.5 0.14	83.0 3.27	89.0 3.50	2.0 0.08	116.0 4.57	110.0 4.33	2.6 0.10	2.1 0.09	69.3	27.0	0.1093	0.94 2.09
25.400 1.0000	19.845 0.7813	0.5 0.02	3.5 0.14	84.0 3.31	91.0 3.58	1.5 0.06	120.0 4.72	115.0 4.53	1.5 0.06	1.7 0.07	98.2	41.8	0.1198	1.22 2.68
25.400 1.0000	19.845 0.7813	0.5 0.02	0.8 0.03	84.0 3.31	85.0 3.35	1.5 0.06	120.0 4.72	115.0 4.53	1.5 0.06	1.7 0.07	98.2	41.8	0.1198	1.23 2.71
23.012 0.9060	19.842 0.7812	1.5 0.06	3.5 0.14	83.0 3.27	89.0 3.50	3.3 0.13	118.0 4.65	112.0 4.41	2.6 0.10	2.1 0.09	69.3	27.0	0.1093	1.16 2.56
23.012 0.9060	19.842 0.7812	1.5 0.06	2.0 0.08	83.0 3.27	86.0 3.39	3.3 0.13	118.0 4.65	112.0 4.41	2.6 0.10	2.1 0.09	69.3	27.0	0.1093	1.17 2.59
31.000 1.2205	22.225 0.8750	-2.8 -0.11	3.5 0.14	84.0 3.31	90.0 3.54	3.3 0.13	121.0 4.76	114.0 4.49	3.3 0.13	0.9 0.04	96.2	28.6	0.1197	1.42 3.13
31.000 1.2205	22.225 0.8750	-2.8 -0.11	6.4 0.25	84.0 3.31	96.0 3.78	3.3 0.13	121.0 4.76	114.0 4.49	3.3 0.13	0.9 0.04	96.2	28.6	0.1197	1.39 3.05
29.769 1.1720	22.225 0.8750	-0.8 -0.03	3.5 0.14	86.0 3.39	92.0 3.62	3.3 0.13	128.0 5.04	120.0 4.72	2.5 0.09	2.2 0.09	104.6	29.3	0.1252	1.68 3.70

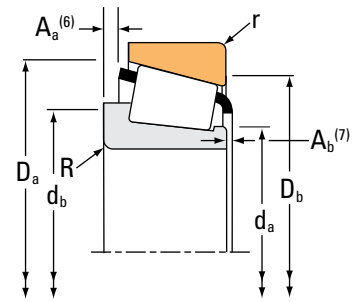
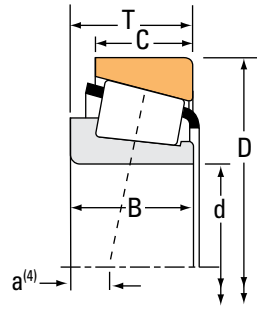
⁽⁴⁾Negative value indicates effective center inside cone (inner-ring) backface.
⁽⁵⁾These maximum fillet radii will be cleared by the bearing corners.
⁽⁶⁾Negative value indicates cage extends beyond cone (inner-ring) backface.
⁽⁷⁾Negative value indicates cage that does not extend beyond cone (inner-ring) front face.

Continued on next page.

TAPERED ROLLER BEARINGS

SINGLE-ROW • TYPE TS

TYPE TS



Bearing Dimensions			Load Ratings							Part Number		
Bore d	O.D. D	Width T	Dynamic ⁽¹⁾		Factors ⁽²⁾		Dynamic ⁽³⁾		Factors ⁽²⁾	Static	Inner	Outer
			C ₁	e	Y	C ₉₀	C _{a90}	K	C ₀			
mm in.	mm in.	mm in.	N lbf			N lbf	N lbf			N lbf		
76.200 3.0000	133.350 5.2500	33.338 1.3125	214000 48100	0.40	1.48	55500 12500	38400 8640	1.44		262000 58900	47679	47620
76.200 3.0000	133.350 5.2500	33.338 1.3125	214000 48100	0.40	1.48	55500 12500	38400 8640	1.44		262000 58900	47680	47620
76.200 3.0000	133.350 5.2500	33.338 1.3125	214000 48100	0.40	1.48	55500 12500	38400 8640	1.44		262000 58900	47678	47620
76.200 3.0000	133.350 5.2500	79.375 1.3125	214000 48100	0.40	1.48	55500 12500	38400 8640	1.44		262000 58900	47679	47620A
76.200 3.0000	133.350 5.2500	39.688 1.5625	259000 58200	0.40	1.49	67100 15100	46200 10400	1.45		353000 79300	HM516442	HM516410
76.200 3.0000	135.733 5.3438	44.450 1.7500	303000 68100	0.41	1.48	78500 17600	54600 12300	1.44		380000 85400	5760	5735
76.200 3.0000	136.525 5.3750	30.162 1.1875	154000 34700	0.44	1.35	40000 9000	30500 6850	1.31		216000 48600	495A	493
76.200 3.0000	136.525 5.3750	30.162 1.1875	154000 34700	0.44	1.35	40000 9000	30500 6850	1.31		216000 48600	495AX	493
76.200 3.0000	136.525 5.3750	46.038 1.8125	319000 71700	0.47	1.27	82700 18600	67000 15100	1.24		405000 91000	H715346	H715311
76.200 3.0000	139.700 5.5000	36.512 1.4375	207000 46500	0.40	1.49	53600 12100	37100 8330	1.45		291000 65400	575	572X
76.200 3.0000	139.700 5.5000	46.038 1.8125	319000 71700	0.47	1.27	82700 18600	67000 15100	1.24		405000 91000	H715346	H715310
76.200 3.0000	139.992 5.5115	36.512 1.4375	207000 46500	0.40	1.49	53600 12100	37100 8330	1.45		291000 65400	575	572
76.200 3.0000	139.992 5.5115	36.512 1.4375	214000 48100	0.40	1.48	55500 12500	38400 8640	1.44		262000 58900	47679	47621
76.200 3.0000	139.992 5.5115	36.512 1.4375	214000 48100	0.40	1.48	55500 12500	38400 8640	1.44		262000 58900	47680	47621
76.200 3.0000	139.992 5.5115	36.512 1.4375	207000 46500	0.40	1.49	53600 12100	37100 8330	1.45		291000 65400	575-S	572
76.200 3.0000	142.138 5.5960	44.450 1.7500	241000 54200	0.39	1.55	62500 14000	41300 9280	1.51		318000 71400	HM515745	HM515716
76.200 3.0000	146.050 5.7500	41.275 1.6250	247000 55500	0.41	1.47	64000 14400	44800 10100	1.43		335000 75300	659	653

⁽¹⁾Based on 1 x 10⁶ revolutions L₁₀ life, for the ISO life-calculation method.

⁽²⁾Consult your Timken engineer for instructions on use or review the Timken Engineering Manual on timken.com/catalogs.

⁽³⁾Based on 90 x 10⁶ revolutions L₁₀ life, for The Timken Company life-calculation method. C₉₀ and C_{a90} are radial and thrust values.

Bearing Dimensions											Geometry Factors			Bearing Weight
Width B	Width C	Eff. Ctr. a ⁽⁴⁾	Shaft			Housing			Cage		G ₁	G ₂	C _g	
			Max Shaft Fillet Radius R ⁽⁵⁾	Backing Shoulder Dia. d _a	Backing Shoulder Dia. d _b	Max Housing Fillet Radius r ⁽⁵⁾	Backing Shoulder Dia. D _a	Backing Shoulder Dia. D _b	A _a ⁽⁶⁾	A _b ⁽⁷⁾				
mm in.	mm in.	mm in.	mm in.	mm in.	mm in.	mm in.	mm in.	mm in.	mm in.	mm in.				kg lbs.
33.338 1.3125	26.195 1.0313	-4.3 -0.17	3.5 0.14	85.0 3.35	91.0 3.58	3.3 0.13	128.0 5.04	119.0 4.69	2.3 0.09	2.4 0.10	119.4	29.2	0.1273	1.92 4.22
33.338 1.3125	26.195 1.0313	-4.3 -0.17	0.8 0.03	85.0 3.35	86.0 3.39	3.3 0.13	128.0 5.04	119.0 4.69	2.3 0.09	2.4 0.10	119.4	29.2	0.1273	1.92 4.23
33.338 1.3125	26.195 1.0313	-4.3 -0.17	6.4 0.25	85.0 3.35	97.0 3.82	3.3 0.13	128.0 5.04	119.0 4.69	2.3 0.09	2.4 0.10	119.4	29.2	0.1273	1.88 4.14
33.338 1.3125	26.195 1.0313	-4.3 -0.17	3.5 0.14	85.0 3.35	91.0 3.58	0.8 0.03	128.0 5.04	121.0 4.76	2.3 0.09	2.4 0.10	119.4	29.2	0.1273	1.92 4.23
39.688 1.5625	32.545 1.2813	-7.4 -0.29	3.5 0.14	87.0 3.43	93.0 3.66	3.3 0.13	128.0 5.04	118.0 4.65	1.7 0.06	2.5 0.10	154.1	43.1	0.0955	2.40 5.30
46.100 1.8150	34.925 1.3750	-11.7 -0.46	3.5 0.14	88.0 3.46	94.0 3.70	3.3 0.13	130.0 5.12	119.0 4.69	5.3 0.21	1.5 0.06	144.9	31.6	0.0940	2.68 5.92
29.769 1.1720	22.225 0.8750	-0.8 -0.03	3.5 0.14	86.0 3.39	92.0 3.62	3.3 0.13	130.0 5.12	122.0 4.80	2.5 0.09	2.2 0.09	104.6	29.3	0.1252	1.80 3.96
29.769 1.1720	22.225 0.8750	-0.8 -0.03	6.4 0.25	86.0 3.39	98.0 3.86	3.3 0.13	130.0 5.12	122.0 4.80	2.5 0.09	2.2 0.09	104.6	29.3	0.1252	1.77 3.90
46.038 1.8125	36.512 1.4375	-8.6 -0.34	3.5 0.14	88.0 3.46	98.0 3.86	3.3 0.13	132.0 5.20	118.0 4.65	4.1 0.16	2.0 0.08	147.1	33.5	0.0993	2.92 6.42
36.098 1.4212	28.575 1.1250	-5.3 -0.21	3.5 0.14	86.0 3.39	92.0 3.62	3.3 0.13	133.0 5.24	125.0 4.92	3.4 0.13	1.9 0.08	125.7	32.0	0.1295	2.34 5.17
46.038 1.8125	36.512 1.4375	-8.6 -0.34	3.5 0.14	88.0 3.46	98.0 3.86	3.3 0.13	133.0 5.24	120.0 4.72	4.1 0.16	2.0 0.08	147.1	33.5	0.0993	3.10 6.82
36.098 1.4212	28.575 1.1250	-5.3 -0.21	3.5 0.14	86.0 3.39	92.0 3.62	3.3 0.13	133.0 5.24	125.0 4.92	3.4 0.13	1.9 0.08	125.7	32.0	0.1295	2.35 5.20
33.338 1.3125	29.370 1.1563	-4.3 -0.17	3.5 0.14	85.0 3.35	91.0 3.58	3.3 0.13	130.0 5.12	122.0 4.80	2.3 0.09	2.4 0.10	119.4	29.2	0.1273	2.33 5.14
33.338 1.3125	29.370 1.1563	-4.3 -0.17	0.8 0.03	85.0 3.35	86.0 3.39	3.3 0.13	130.0 5.12	122.0 4.80	2.3 0.09	2.4 0.10	119.4	29.2	0.1273	2.33 5.15
36.098 1.4212	28.575 1.1250	-5.3 -0.21	6.8 0.27	86.0 3.39	99.0 3.90	3.3 0.13	133.0 5.24	125.0 4.92	3.4 0.13	1.9 0.08	125.7	32.0	0.1295	2.32 5.12
46.100 1.8150	33.338 1.3125	-10.9 -0.43	3.5 0.14	87.0 3.43	92.0 3.62	3.3 0.13	133.0 5.24	124.0 4.88	5.9 0.23	-1.2 -0.05	121.7	26.3	0.0869	2.90 6.41
41.275 1.6250	31.750 1.2500	-7.9 -0.31	3.5 0.14	87.0 3.43	93.0 3.66	3.3 0.13	139.0 5.47	131.0 5.16	4.5 0.17	2.1 0.08	136.6	27.3	0.0919	3.01 6.63

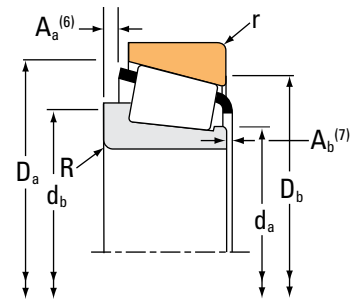
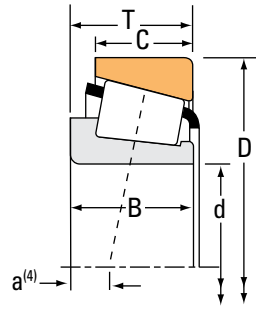
⁽⁴⁾Negative value indicates effective center inside cone (inner-ring) backface.
⁽⁵⁾These maximum fillet radii will be cleared by the bearing corners.
⁽⁶⁾Negative value indicates cage extends beyond cone (inner-ring) backface.
⁽⁷⁾Negative value indicates cage that does not extend beyond cone (inner-ring) front face.

Continued on next page.

TAPERED ROLLER BEARINGS

SINGLE-ROW • TYPE TS

TYPE TS



Bearing Dimensions			Load Ratings							Part Number		
Bore d	O.D. D	Width T	Dynamic ⁽¹⁾ C ₁		Factors ⁽²⁾ e Y		Dynamic ⁽³⁾ C ₉₀ C _{a90}		Factors ⁽²⁾ K	Static C ₀	Inner	Outer
			N lbf				N lbf	N lbf		N lbf		
mm in.	mm in.	mm in.										
76.200 3.0000	149.225 5.8750	53.975 2.1250	411000 92400		0.36	1.66	107000 24000	66000 14800	1.61	463000 104000	6461	6420
76.200 3.0000	149.225 5.8750	53.975 2.1250	411000 92400		0.36	1.66	107000 24000	66000 14800	1.61	463000 104000	6466	6420
76.200 3.0000	149.225 5.8750	53.975 2.1250	411000 92400		0.36	1.66	107000 24000	66000 14800	1.61	463000 104000	6461A	6420
76.200 3.0000	150.000 5.9055	35.966 1.4160	216000 48600		0.44	1.36	56000 12600	42400 9530	1.32	319000 71600	590A	JM719113
76.200 3.0000	150.089 5.9090	44.450 1.7500	377000 84700		0.33	1.84	97600 21900	54400 12200	1.80	417000 93800	748-S	742
76.200 3.0000	152.400 6.0000	39.688 1.5625	216000 48600		0.44	1.36	56000 12600	42400 9530	1.32	319000 71600	590A	592A
76.200 3.0000	152.400 6.0000	41.275 1.6250	247000 55500		0.41	1.47	64000 14400	44800 10100	1.43	335000 75300	659	652
76.200 3.0000	160.000 6.2992	53.975 2.1250	439000 98800		0.40	1.50	114000 25600	78100 17600	1.46	523000 118000	6576	6525X
76.200 3.0000	161.925 6.3750	47.625 1.8750	327000 73600		0.34	1.76	84800 19100	49500 11100	1.71	441000 99200	755	752
76.200 3.0000	161.925 6.3750	49.212 1.9375	353000 79300		0.71	0.85	91400 20600	111000 24900	0.82	330000 74200	9285	9220
76.200 3.0000	161.925 6.3750	53.975 2.1250	439000 98800		0.40	1.50	114000 25600	78100 17600	1.46	523000 118000	6576	6535
76.200 3.0000	161.925 6.3750	53.975 2.1250	439000 98800		0.40	1.50	114000 25600	78100 17600	1.46	523000 118000	6575	6535
76.200 3.0000	161.925 6.3750	53.975 2.1250	439000 98800		0.40	1.50	114000 25600	78100 17600	1.46	523000 118000	6576	6536
76.200 3.0000	161.925 6.3750	53.975 2.1250	439000 98800		0.40	1.50	114000 25600	78100 17600	1.46	523000 118000	6576C	6535
76.200 3.0000	168.275 6.6250	47.625 1.8750	327000 73600		0.34	1.76	84800 19100	49500 11100	1.71	441000 99200	755	753
76.200 3.0000	168.275 6.6250	53.975 2.1250	485000 109000		0.30	2.00	126000 28300	64400 14500	1.95	522000 117000	837	832
76.200 3.0000	168.275 6.6250	53.975 2.1250	485000 109000		0.30	2.00	126000 28300	64400 14500	1.95	522000 117000	843	832

⁽¹⁾Based on 1×10^6 revolutions L_{10} life, for the ISO life-calculation method.

⁽²⁾Consult your Timken engineer for instructions on use or review the Timken Engineering Manual on timken.com/catalogs.

⁽³⁾Based on 90×10^6 revolutions L_{10} life, for The Timken Company life-calculation method. C_{90} and C_{a90} are radial and thrust values.

Bearing Dimensions											Geometry Factors			Bearing Weight
Width B	Width C	Eff. Ctr. a ⁽⁴⁾	Shaft			Housing			Cage		G ₁	G ₂	C _g	
			Max Shaft Fillet Radius R ⁽⁵⁾	Backing Shoulder Dia. d _a d _b		Max Housing Fillet Radius r ⁽⁵⁾	Backing Shoulder Dia. D _a D _b		A _a ⁽⁶⁾	A _b ⁽⁷⁾				
mm in.	mm in.	mm in.	mm in.	mm in.	mm in.	mm in.	mm in.	mm in.	mm in.	mm in.				kg lbs.
54.229 2.1350	44.450 1.7500	-15.0 -0.59	3.5 0.14	89.0 3.52	96.0 3.78	3.3 0.13	140.0 5.51	129.0 5.08	2.7 0.10	0.7 0.03	158.3	29.1	0.0931	4.24 9.36
54.229 2.1350	44.450 1.7500	-15.0 -0.59	6.4 0.25	89.0 3.52	102.0 4.02	3.3 0.13	140.0 5.51	129.0 5.08	2.7 0.10	0.7 0.03	158.3	29.1	0.0931	4.22 9.30
54.229 2.1350	44.450 1.7500	-15.0 -0.59	9.7 0.38	89.0 3.52	108.0 4.25	3.3 0.13	140.0 5.51	129.0 5.08	2.7 0.10	0.7 0.03	158.3	29.1	0.0931	4.16 9.18
36.322 1.4300	27.000 1.0630	-2.5 -0.10	3.5 0.14	89.0 3.50	95.0 3.74	2.5 0.10	143.0 5.63	135.0 5.31	4.1 0.16	1.7 0.07	151.4	38.3	0.1416	2.92 6.44
46.672 1.8375	36.512 1.4375	-11.9 -0.47	3.5 0.14	87.0 3.43	93.0 3.66	3.3 0.13	142.0 5.59	134.0 5.28	1.8 0.07	1.3 0.05	159.6	26.3	0.0898	3.66 8.06
36.322 1.4300	30.162 1.1875	-2.5 -0.10	3.5 0.14	89.0 3.50	95.0 3.74	3.3 0.13	144.0 5.67	135.0 5.31	4.1 0.16	1.7 0.07	151.4	38.3	0.1416	3.21 7.08
41.275 1.6250	31.750 1.2500	-7.9 -0.31	3.5 0.14	87.0 3.43	93.0 3.66	3.3 0.13	141.0 5.55	134.0 5.28	4.5 0.17	2.1 0.08	136.6	27.3	0.0919	3.36 7.41
55.100 2.1693	44.450 1.7500	-13.2 -0.52	3.5 0.14	92.0 3.62	99.0 3.90	3.0 0.12	153.4 6.04	141.0 5.55	4.1 0.16	0.9 0.04	198.6	33.5	0.1037	5.26 11.60
48.260 1.9000	38.100 1.5000	-11.9 -0.47	3.5 0.14	92.0 3.62	98.0 3.86	3.3 0.13	150.0 5.91	144.0 5.67	3.2 0.12	1.0 0.04	177.2	29.4	0.0945	4.70 10.36
46.038 1.8125	31.750 1.2500	0.0 0.00	3.5 0.14	89.0 3.50	111.0 4.37	3.3 0.13	153.0 6.03	138.0 5.43	9.0 0.35	4.1 0.16	102.5	16.1	0.0984	4.17 9.21
55.100 2.1693	42.862 1.6875	-13.2 -0.52	3.5 0.14	92.0 3.62	99.0 3.90	3.3 0.13	154.0 6.06	141.0 5.55	4.1 0.16	0.9 0.04	198.6	33.5	0.1037	5.41 11.93
55.100 2.1693	42.862 1.6875	-13.2 -0.52	6.4 0.25	92.0 3.62	104.0 4.09	3.3 0.13	154.0 6.06	141.0 5.55	4.1 0.16	0.9 0.04	198.6	33.5	0.1037	5.40 11.91
55.100 2.1693	42.862 1.6875	-13.2 -0.52	3.5 0.14	92.0 3.62	99.0 3.90	0.8 0.03	154.0 6.06	144.0 5.67	4.1 0.16	0.9 0.04	198.6	33.5	0.1037	5.41 11.94
55.100 2.1693	42.862 1.6875	-13.2 -0.52	3.5 0.14	94.0 3.70	101.0 3.98	3.3 0.13	154.0 6.06	141.0 5.55	4.1 0.16	0.9 0.04	198.6	33.5	0.1037	5.41 11.92
48.260 1.9000	38.100 1.5000	-11.9 -0.47	3.5 0.14	92.0 3.62	98.0 3.86	3.3 0.13	150.0 5.91	147.0 5.79	3.2 0.12	1.0 0.04	177.2	29.4	0.0945	5.17 11.40
56.363 2.2190	41.275 1.6250	-18.5 -0.73	0.8 0.03	89.0 3.50	90.0 3.54	3.3 0.13	155.0 6.10	149.0 5.87	5.2 0.20	1.6 0.07	197.9	34.8	0.0937	5.79 12.75
56.363 2.2190	41.275 1.6250	-18.5 -0.73	6.4 0.25	89.0 3.50	101.0 3.98	3.3 0.13	155.0 6.10	149.0 5.87	5.2 0.20	1.6 0.07	197.9	34.8	0.0937	5.77 12.71

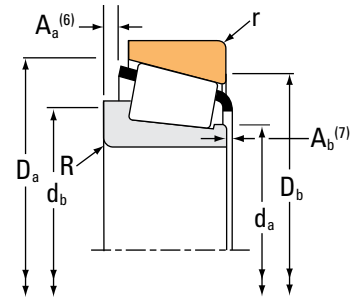
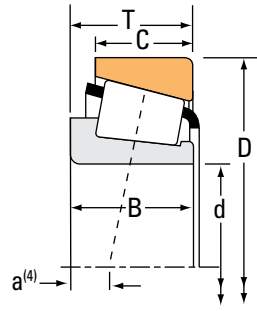
⁽⁴⁾Negative value indicates effective center inside cone (inner-ring) backface.
⁽⁵⁾These maximum fillet radii will be cleared by the bearing corners.
⁽⁶⁾Negative value indicates cage extends beyond cone (inner-ring) backface.
⁽⁷⁾Negative value indicates cage that does not extend beyond cone (inner-ring) front face.

Continued on next page.

TAPERED ROLLER BEARINGS

SINGLE-ROW • TYPE TS

TYPE TS



Bearing Dimensions			Load Ratings							Part Number			
Bore d	O.D. D	Width T	Dynamic ⁽¹⁾		Factors ⁽²⁾		Dynamic ⁽³⁾		Factors ⁽²⁾		Static C ₀	Inner	Outer
			C ₁	e	Y	C ₉₀	C _{a90}	K	N	N			
mm in.	mm in.	mm in.	N lbf			N lbf	N lbf		N lbf				
76.200 3.0000	171.450 6.7500	49.212 1.9375	363000 81600	0.76	0.79	94100 21200	123000 27700	0.76	351000 78800		9380	9321	
76.200 3.0000	171.450 6.7500	52.388 2.0625	363000 81600	0.76	0.79	94100 21200	123000 27700	0.76	351000 78800		9378	9321	
76.200 3.0000	177.800 7.0000	52.388 2.0625	363000 81600	0.76	0.79	94100 21200	123000 27700	0.76	351000 78800		9380	9320	
76.200 3.0000	177.800 7.0000	55.562 2.1875	363000 81600	0.76	0.79	94100 21200	123000 27700	0.76	351000 78800		9378	9320	
76.200 3.0000	180.975 7.1250	53.975 2.1250	448000 101000	0.73	0.82	116000 26100	146000 32700	0.80	458000 103000		H917840	H917810	
76.200 3.0000	190.500 7.5000	57.150 2.2500	534000 120000	0.33	1.79	138000 31100	79300 17800	1.74	692000 156000		HH221430	HH221410	
77.788 3.0625	117.475 4.6250	25.400 1.0000	118000 26500	0.51	1.18	30600 6870	26700 5990	1.15	183000 41200		LM814849	LM814810	
77.788 3.0625	120.000 4.7244	23.000 0.9055	121000 27200	0.45	1.33	31400 7060	24200 5450	1.30	136000 30600		34306	34472X	
77.788 3.0625	120.650 4.7500	27.783 1.0938	118000 26500	0.51	1.18	30600 6870	26700 5990	1.15	183000 41200		LM814849	LM814814	
77.788 3.0625	121.442 4.7812	24.608 0.9688	121000 27200	0.45	1.33	31400 7060	24200 5450	1.30	136000 30600		34306	34478	
77.788 3.0625	121.442 4.7812	24.608 0.9688	102000 23000	0.45	1.33	26500 5960	20500 4600	1.30	136000 30600		34307	34478	
77.788 3.0625	127.000 5.0000	30.162 1.1875	161000 36200	0.42	1.43	41800 9390	29900 6730	1.39	222000 49800		42690	42620	
77.788 3.0625	133.350 5.2500	30.162 1.1875	154000 34700	0.44	1.35	40000 9000	30500 6850	1.31	216000 48600		495AS	492A	
77.788 3.0625	135.733 5.3438	44.450 1.7500	303000 68100	0.41	1.48	78500 17600	54600 12300	1.44	380000 85400		5795	5735	
77.788 3.0625	136.525 5.3750	46.038 1.8125	319000 71700	0.47	1.27	82700 18600	67000 15100	1.24	405000 91000		H715348	H715311	
77.788 3.0625	139.700 5.5000	46.038 1.8125	319000 71700	0.47	1.27	82700 18600	67000 15100	1.24	405000 91000		H715348	H715310	
77.788 3.0625	164.975 6.4951	49.500 1.9488	352000 79000	0.51	1.17	91100 20500	79700 17900	1.14	400000 90000		H816249	H816210	

⁽¹⁾Based on 1 x 10⁶ revolutions L₁₀ life, for the ISO life-calculation method.

⁽²⁾Consult your Timken engineer for instructions on use or review the Timken Engineering Manual on timken.com/catalogs.

⁽³⁾Based on 90 x 10⁶ revolutions L₁₀ life, for The Timken Company life-calculation method. C₉₀ and C_{a90} are radial and thrust values.

Bearing Dimensions											Geometry Factors			Bearing Weight
Width B	Width C	Eff. Ctr. a ⁽⁴⁾	Shaft			Housing			Cage		G ₁	G ₂	C _g	
			Max Shaft Fillet Radius R ⁽⁵⁾	Backing Shoulder Dia. d _a	Shoulder Dia. d _b	Max Housing Fillet Radius r ⁽⁵⁾	Backing Shoulder Dia. D _a	Shoulder Dia. D _b	A _a ⁽⁶⁾	A _b ⁽⁷⁾				
mm in.	mm in.	mm in.	mm in.	mm in.	mm in.	mm in.	mm in.	mm in.	mm in.	mm in.				kg lbs.
46.038 1.8125	31.750 1.2500	4.3 0.17	3.5 0.14	98.2 3.87	105.0 4.13	3.3 0.13	164.0 6.46	147.0 5.79	8.9 0.35	3.9 0.16	117.9	18.6	0.1053	5.11 11.26
50.800 2.0000	31.750 1.2500	1.3 0.05	3.5 0.14	98.2 3.87	105.0 4.13	3.3 0.13	164.0 6.46	147.0 5.79	12.1 0.47	2.3 0.09	117.9	18.6	0.1053	5.35 11.80
46.038 1.8125	34.925 1.3750	4.3 0.17	3.5 0.14	98.2 3.87	105.0 4.13	3.3 0.13	164.0 6.46	148.0 5.83	8.9 0.35	3.9 0.16	117.9	18.6	0.1053	5.81 12.80
50.800 2.0000	34.925 1.3750	1.3 0.05	3.5 0.14	98.2 3.87	105.0 4.13	3.3 0.13	164.0 6.46	148.0 5.83	12.1 0.47	2.3 0.09	117.9	18.6	0.1053	6.05 13.34
53.183 2.0938	35.720 1.4063	0.5 0.02	3.5 0.14	100.1 3.94	110.0 4.33	3.3 0.13	170.0 6.69	152.0 5.98	9.5 0.37	2.8 0.11	147.0	20.7	0.1123	6.55 14.45
57.531 2.2650	46.038 1.8125	-15.0 -0.59	3.5 0.14	95.0 3.74	101.0 3.98	3.3 0.13	179.0 7.05	171.0 6.73	2.5 0.10	3.2 0.13	265.6	28.4	0.1072	8.60 18.95
25.400 1.0000	19.050 0.7500	2.3 0.09	3.5 0.14	85.0 3.35	91.0 3.58	3.3 0.13	113.0 4.45	105.0 4.13	2.4 0.09	1.5 0.06	88.6	36.6	0.1239	0.91 2.00
23.012 0.9060	16.000 0.6299	1.5 0.06	3.5 0.14	84.0 3.31	91.0 3.58	2.3 0.09	115.0 4.53	110.0 4.33	2.6 0.10	2.1 0.09	69.3	27.0	0.1093	0.83 1.84
25.400 1.0000	26.195 1.0313	2.3 0.09	3.5 0.14	85.0 3.35	91.0 3.58	3.3 0.13	115.8 4.56	107.0 4.21	2.4 0.09	1.5 0.06	88.6	36.6	0.1239	1.11 2.45
23.012 0.9060	17.462 0.6875	1.5 0.06	3.5 0.14	84.0 3.31	91.0 3.58	2.0 0.08	116.0 4.57	110.0 4.33	2.6 0.10	2.1 0.09	69.3	27.0	0.1093	0.90 2.01
23.012 0.9060	17.462 0.6875	1.5 0.06	6.4 0.25	84.0 3.31	96.0 3.78	2.0 0.08	116.0 4.57	110.0 4.33	2.6 0.10	2.1 0.09	69.3	27.0	0.1093	0.88 1.95
31.000 1.2205	22.225 0.8750	-2.8 -0.11	3.5 0.14	85.0 3.35	91.0 3.58	3.3 0.13	121.0 4.76	114.0 4.49	3.3 0.13	0.9 0.04	96.2	28.6	0.1197	1.37 3.01
29.769 1.1720	22.225 0.8750	-0.8 -0.03	3.5 0.14	87.0 3.43	93.0 3.66	3.3 0.13	128.0 5.04	120.0 4.72	2.5 0.09	2.2 0.09	104.6	29.3	0.1252	1.63 3.61
46.100 1.8150	34.925 1.3750	-11.7 -0.46	3.5 0.14	89.0 3.50	96.0 3.78	3.3 0.13	130.0 5.12	119.0 4.69	5.3 0.21	1.5 0.06	144.9	31.6	0.0940	2.61 5.77
46.038 1.8125	36.512 1.4375	-8.6 -0.34	3.5 0.14	88.0 3.46	99.0 3.90	3.3 0.13	132.0 5.20	118.0 4.65	4.1 0.16	2.0 0.08	147.1	33.5	0.0993	2.84 6.26
46.038 1.8125	36.512 1.4375	-8.6 -0.34	3.5 0.14	88.0 3.46	99.0 3.90	3.3 0.13	133.0 5.24	120.0 4.72	4.1 0.16	2.0 0.08	147.1	33.5	0.0993	3.02 6.67
46.248 1.8208	36.250 1.4272	-6.4 -0.25	3.5 0.14	92.5 3.64	102.0 4.02	3.3 0.13	154.5 6.08	144.0 5.67	4.6 0.18	6.0 0.24	127.4	23.2	0.0959	4.63 10.21

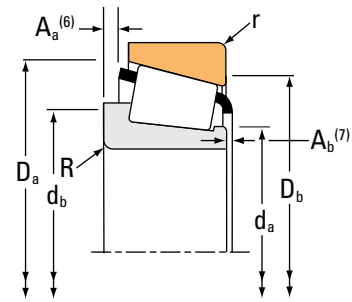
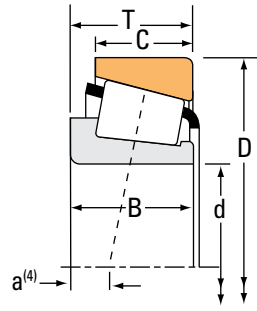
⁽⁴⁾Negative value indicates effective center inside cone (inner-ring) backface.
⁽⁵⁾These maximum fillet radii will be cleared by the bearing corners.
⁽⁶⁾Negative value indicates cage extends beyond cone (inner-ring) backface.
⁽⁷⁾Negative value indicates cage that does not extend beyond cone (inner-ring) front face.

Continued on next page.

TAPERED ROLLER BEARINGS

SINGLE-ROW • TYPE TS

TYPE TS



Bearing Dimensions			Load Ratings							Part Number		
Bore d	O.D. D	Width T	Dynamic ⁽¹⁾		Factors ⁽²⁾		Dynamic ⁽³⁾		Factors ⁽²⁾	Static	Inner	Outer
			C ₁	e	Y	C ₉₀	C _{a90}	K	C ₀			
mm in.	mm in.	mm in.	N lbf			N lbf	N lbf			N lbf		
79.375 3.1250	140.000 5.5118	44.450 1.7500	241000 54200	0.39	1.55	62500 14000	41300 9280	1.51		318000 71400	HM515749	HM515714
79.375 3.1250	142.138 5.5960	44.450 1.7500	241000 54200	0.39	1.55	62500 14000	41300 9280	1.51		318000 71400	HM515749	HM515716
79.375 3.1250	146.050 5.7500	41.275 1.6250	247000 55500	0.41	1.47	64000 14400	44800 10100	1.43		335000 75300	661	653
79.375 3.1250	147.638 5.8125	35.717 1.4062	216000 48600	0.44	1.36	56000 12600	42400 9530	1.32		319000 71600	595A	592XE
79.375 3.1250	150.000 5.9055	35.992 1.4170	216000 48600	0.44	1.36	56000 12600	42400 9530	1.32		319000 71600	595A	593X
79.375 3.1250	150.089 5.9090	44.450 1.7500	377000 84700	0.33	1.84	97600 21900	54400 12200	1.80		417000 93800	750	742
79.375 3.1250	152.400 6.0000	35.717 1.4062	216000 48600	0.44	1.36	56000 12600	42400 9530	1.32		319000 71600	595A	592AS
79.375 3.1250	152.400 6.0000	39.688 1.5625	216000 48600	0.44	1.36	56000 12600	42400 9530	1.32		319000 71600	595A	592A
79.375 3.1250	152.400 6.0000	41.275 1.6250	247000 55500	0.41	1.47	64000 14400	44800 10100	1.43		335000 75300	661	652
79.375 3.1250	161.925 6.3750	47.625 1.8750	327000 73600	0.34	1.76	84800 19100	49500 11100	1.71		441000 99200	756A	752
79.375 3.1250	190.500 7.5000	57.150 2.2500	534000 120000	0.33	1.79	138000 31100	79300 17800	1.74		692000 156000	HH221431	HH221410
79.975 3.1486	146.975 5.7864	40.000 1.5748	325000 73000	0.33	1.80	84200 18900	47900 10800	1.76		388000 87300	HM218238	HM218210
79.975 3.1486	152.400 6.0000	40.000 1.5748	325000 73000	0.33	1.80	84200 18900	47900 10800	1.76		388000 87300	HM218238	HM218215
79.985 3.1490	139.992 5.5115	36.512 1.4375	207000 46500	0.40	1.49	53600 12100	37100 8330	1.45		291000 65400	578	572
79.985 3.1490	147.638 5.8125	35.717 1.4062	216000 48600	0.44	1.36	56000 12600	42400 9530	1.32		319000 71600	590	592XE
79.985 3.1490	152.400 6.0000	39.688 1.5625	216000 48600	0.44	1.36	56000 12600	42400 9530	1.32		319000 71600	590	592A
80.000 3.1496	125.000 4.9213	24.000 0.9449	107000 24000	0.45	1.33	27700 6230	21400 4820	1.29		141000 31800	JP8049	JP8010

⁽¹⁾Based on 1 x 10⁶ revolutions L₁₀ life, for the ISO life-calculation method.

⁽²⁾Consult your Timken engineer for instructions on use or review the Timken Engineering Manual on timken.com/catalogs.

⁽³⁾Based on 90 x 10⁶ revolutions L₁₀ life, for The Timken Company life-calculation method. C₉₀ and C_{a90} are radial and thrust values.

Bearing Dimensions											Geometry Factors			Bearing Weight
Width B	Width C	Eff. Ctr. a ⁽⁴⁾	Shaft			Housing			Cage		G ₁	G ₂	C _g	
			Max Shaft Fillet Radius R ⁽⁵⁾	Backing Shoulder Dia. d _a d _b		Max Housing Fillet Radius r ⁽⁵⁾	Backing Shoulder Dia. D _a D _b		A _a ⁽⁶⁾	A _b ⁽⁷⁾				
mm in.	mm in.	mm in.	mm in.	mm in.	mm in.	mm in.	mm in.	mm in.	mm in.	mm in.				kg lbs.
46.100 1.8150	33.338 1.3125	-10.9 -0.43	3.5 0.14	89.6 3.52	95.0 3.74	3.3 0.13	133.0 5.24	123.0 4.84	5.9 0.23	-1.2 -0.05	121.7	26.3	0.0869	2.64 5.83
46.100 1.8150	33.338 1.3125	-10.9 -0.43	3.5 0.14	89.6 3.52	95.0 3.74	3.3 0.13	133.0 5.24	124.0 4.88	5.9 0.23	-1.2 -0.05	121.7	26.3	0.0869	2.76 6.10
41.275 1.6250	31.750 1.2500	-7.9 -0.31	3.5 0.14	90.0 3.54	96.0 3.78	3.3 0.13	139.0 5.47	131.0 5.16	4.5 0.17	2.1 0.08	136.6	27.3	0.0919	2.88 6.35
36.322 1.4300	26.192 1.0312	-2.5 -0.10	3.5 0.14	91.0 3.58	98.0 3.86	0.8 0.03	142.0 5.59	135.0 5.31	4.1 0.16	1.7 0.07	151.4	38.3	0.1416	2.69 5.93
36.322 1.4300	27.000 1.0630	-2.5 -0.10	3.5 0.14	91.0 3.58	98.0 3.86	3.0 0.12	142.0 5.59	134.0 5.28	4.1 0.16	1.7 0.07	151.4	38.3	0.1416	2.81 6.19
46.672 1.8375	36.512 1.4375	-11.9 -0.47	3.5 0.14	90.0 3.54	96.0 3.78	3.3 0.13	142.0 5.59	134.0 5.28	1.8 0.07	1.3 0.05	159.6	26.3	0.0898	3.51 7.73
36.322 1.4300	26.192 1.0312	-2.5 -0.10	3.5 0.14	91.0 3.58	98.0 3.86	0.8 0.03	144.0 5.67	137.0 5.39	4.1 0.16	1.7 0.07	151.4	38.3	0.1416	2.93 6.45
36.322 1.4300	30.162 1.1875	-2.5 -0.10	3.5 0.14	91.0 3.58	98.0 3.86	3.3 0.13	144.0 5.67	135.0 5.31	4.1 0.16	1.7 0.07	151.4	38.3	0.1416	3.10 6.84
41.275 1.6250	31.750 1.2500	-7.9 -0.31	3.5 0.14	90.0 3.54	96.0 3.78	3.3 0.13	141.0 5.55	134.0 5.28	4.5 0.17	2.1 0.08	136.6	27.3	0.0919	3.23 7.14
48.260 1.9000	38.100 1.5000	-11.9 -0.47	8.0 0.31	94.0 3.70	109.0 4.29	3.3 0.13	150.0 5.91	144.0 5.67	3.2 0.12	1.0 0.04	177.2	29.4	0.0945	4.53 9.99
57.531 2.2650	46.038 1.8125	-15.0 -0.59	3.5 0.14	97.0 3.82	103.0 4.06	3.3 0.13	179.0 7.05	171.0 6.73	2.5 0.10	3.2 0.13	265.6	28.4	0.1072	8.42 18.57
40.000 1.5748	32.500 1.2795	-8.6 -0.34	7.0 0.28	91.0 3.58	104.0 4.09	3.5 0.14	141.0 5.55	133.0 5.24	1.4 0.05	3.0 0.12	168.2	34.7	0.0921	2.94 6.50
40.000 1.5748	32.500 1.2795	-8.6 -0.34	7.0 0.28	91.0 3.58	104.0 4.09	3.3 0.13	143.0 5.63	135.0 5.31	1.4 0.05	3.0 0.12	168.2	34.7	0.0921	3.27 7.22
36.098 1.4212	28.575 1.1250	-5.3 -0.21	3.5 0.14	89.0 3.50	95.0 3.74	3.3 0.13	133.0 5.24	125.0 4.92	3.4 0.13	1.9 0.08	125.7	32.0	0.1295	2.22 4.91
36.322 1.4300	26.192 1.0312	-2.5 -0.10	3.5 0.14	91.0 3.58	98.0 3.86	0.8 0.03	142.0 5.59	135.0 5.31	4.1 0.16	1.7 0.07	151.4	38.3	0.1416	2.67 5.88
36.322 1.4300	30.162 1.1875	-2.5 -0.10	3.5 0.14	91.0 3.58	98.0 3.86	3.3 0.13	144.0 5.67	135.0 5.31	4.1 0.16	1.7 0.07	151.4	38.3	0.1416	3.08 6.79
22.500 0.8858	17.500 0.6890	2.3 0.09	2.0 0.08	86.0 3.39	89.0 3.50	2.0 0.08	120.0 4.72	115.0 4.53	1.9 0.07	3.5 0.14	69.7	37.4	0.1095	0.96 2.10

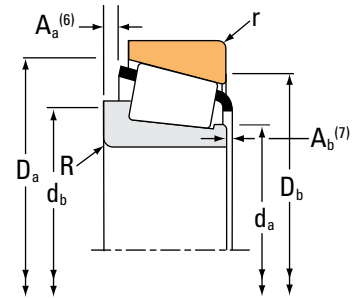
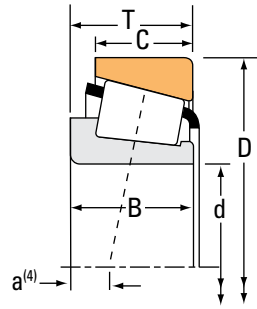
(4) Negative value indicates effective center inside cone (inner-ring) backface.
 (5) These maximum fillet radii will be cleared by the bearing corners.
 (6) Negative value indicates cage extends beyond cone (inner-ring) backface.
 (7) Negative value indicates cage that does not extend beyond cone (inner-ring) front face.

Continued on next page.

TAPERED ROLLER BEARINGS

SINGLE-ROW • TYPE TS

TYPE TS



Bearing Dimensions			Load Ratings							Part Number			
Bore d	O.D. D	Width T	Dynamic ⁽¹⁾		Factors ⁽²⁾		Dynamic ⁽³⁾		Factors ⁽²⁾		Static C ₀	Inner	Outer
			C ₁	e	Y	C ₉₀	C _{a90}	K	N	N			
mm in.	mm in.	mm in.	N lbf			N lbf	N lbf		N lbf				
80.000 3.1496	130.000 5.1181	35.000 1.3780	235000 52900	0.39	1.54	61000 13700	40600 9120	1.50	283000 63500			JM515649	JM515610
80.000 3.1496	150.000 5.9055	44.455 1.7502	318000 71400	0.33	1.84	82400 18500	45900 10300	1.80	417000 93800			748	743
80.000 3.1496	150.089 5.9090	44.450 1.7500	318000 71400	0.33	1.84	82400 18500	45900 10300	1.80	417000 93800			748	742
80.000 3.1496	160.000 6.2992	45.000 1.7717	313000 70300	0.87	0.69	81100 18200	120000 27000	0.67	339000 76100			JW8049	JW8010
80.000 3.1496	200.000 7.8740	108.268 2.0772	482000 108000	0.63	0.95	125000 28100	135000 30400	0.92	519000 117000			98316	98788
80.962 3.1875	133.350 5.2500	30.162 1.1875	154000 34700	0.44	1.35	40000 9000	30500 6850	1.31	216000 48600			496	492A
80.962 3.1875	133.350 5.2500	33.338 1.3125	214000 48100	0.40	1.48	55500 12500	38400 8640	1.44	262000 58900			47681	47620
80.962 3.1875	133.350 5.2500	39.688 1.5625	259000 58200	0.40	1.49	67100 15100	46200 10400	1.45	353000 79300			HM516447	HM516410
80.962 3.1875	133.350 5.2500	39.688 1.5625	259000 58200	0.40	1.49	67100 15100	46200 10400	1.45	353000 79300			HM516447	HM516410A
80.962 3.1875	136.525 5.3750	30.162 1.1875	154000 34700	0.44	1.35	40000 9000	30500 6850	1.31	216000 48600			496	493
80.962 3.1875	139.992 5.5115	36.512 1.4375	207000 46500	0.40	1.49	53600 12100	37100 8330	1.45	291000 65400			581	572
80.962 3.1875	146.050 5.7500	38.100 1.5000	247000 55500	0.41	1.47	64000 14400	44800 10100	1.43	335000 75300			662	653
80.962 3.1875	150.089 5.9090	44.450 1.7500	377000 84700	0.33	1.84	97600 21900	54400 12200	1.80	417000 93800			740	742
80.962 3.1875	168.275 6.6250	53.975 2.1250	409000 92000	0.30	2.00	106000 23800	54300 12200	1.95	522000 117000			838	832
82.550 3.2500	114.300 4.5000	15.083 0.5938	70900 15900	0.31	1.94	18400 4130	9740 2190	1.89	87000 19600			LL116249	LL116210
82.550 3.2500	115.888 4.5625	20.638 0.8125	90200 20300	0.31	1.95	23400 5260	12300 2770	1.90	147000 33100			L116149	L116110
82.550 3.2500	125.412 4.9375	25.400 1.0000	117000 26300	0.42	1.44	30400 6830	21600 4860	1.40	178000 39900			27687	27620

⁽¹⁾Based on 1 x 10⁶ revolutions L₁₀ life, for the ISO life-calculation method.

⁽²⁾Consult your Timken engineer for instructions on use or review the Timken Engineering Manual on timken.com/catalogs.

⁽³⁾Based on 90 x 10⁶ revolutions L₁₀ life, for The Timken Company life-calculation method. C₉₀ and C_{a90} are radial and thrust values.

Bearing Dimensions											Geometry Factors			Bearing Weight
Width B	Width C	Eff. Ctr. a ⁽⁴⁾	Shaft			Housing			Cage		G ₁	G ₂	C _g	
			Max Shaft Fillet Radius R ⁽⁵⁾	Backing Shoulder Dia. d _a	Backing Shoulder Dia. d _b	Max Housing Fillet Radius r ⁽⁵⁾	Backing Shoulder Dia. D _a	Backing Shoulder Dia. D _b	A _a ⁽⁶⁾	A _b ⁽⁷⁾				
mm in.	mm in.	mm in.	mm in.	mm in.	mm in.	mm in.	mm in.	mm in.	mm in.	mm in.				kg lbs.
34.000 1.3386	28.500 1.1220	-5.1 -0.20	3.0 0.12	88.0 3.46	94.0 3.70	2.5 0.10	125.0 4.92	117.0 4.61	1.5 0.06	2.8 0.11	118.5	31.1	0.0863	1.71 3.77
46.672 1.8375	35.000 1.3780	-11.9 -0.47	3.0 0.12	90.0 3.54	96.0 3.78	3.3 0.13	142.0 5.59	134.0 5.28	1.8 0.07	1.3 0.05	159.6	26.3	0.0898	3.44 7.57
46.672 1.8375	36.512 1.4375	-11.9 -0.47	3.0 0.12	90.0 3.54	96.0 3.78	3.3 0.13	142.0 5.59	134.0 5.28	1.8 0.07	1.3 0.05	159.6	26.3	0.0898	3.49 7.67
41.000 1.6142	31.000 1.2205	9.7 0.38	3.0 0.12	93.0 3.67	108.0 4.25	3.0 0.12	152.0 5.98	134.0 5.28	7.0 0.27	4.8 0.19	117.3	27.2	0.1094	4.04 8.90
49.212 1.9375	34.925 1.3750	1.3 0.05	3.5 0.14	105.0 4.13	111.0 4.37	3.3 0.13	188.0 7.40	174.0 6.85	8.6 0.34	5.4 0.22	203.4	37.5	0.1197	7.94 17.52
29.769 1.1720	22.225 0.8750	-0.8 -0.03	3.5 0.14	89.0 3.50	95.0 3.74	3.3 0.13	128.0 5.04	120.0 4.72	2.5 0.09	2.2 0.09	104.6	29.3	0.1252	1.54 3.40
33.338 1.3125	26.195 1.0313	-4.3 -0.17	3.5 0.14	89.0 3.50	95.0 3.74	3.3 0.13	128.0 5.04	119.0 4.69	2.3 0.09	2.4 0.10	119.4	29.2	0.1273	1.76 3.86
39.688 1.5625	32.545 1.2813	-7.4 -0.29	3.5 0.14	91.0 3.58	98.0 3.86	3.3 0.13	128.0 5.04	118.0 4.65	1.7 0.06	2.5 0.10	154.1	43.1	0.0955	2.22 4.90
39.688 1.5625	32.545 1.2813	-7.4 -0.29	3.5 0.14	91.0 3.58	98.0 3.86	0.8 0.03	128.0 5.04	120.0 4.72	1.7 0.06	2.5 0.10	154.1	43.1	0.0955	2.23 4.93
29.769 1.1720	22.225 0.8750	-0.8 -0.03	3.5 0.14	89.0 3.50	95.0 3.74	3.3 0.13	130.0 5.12	122.0 4.80	2.5 0.09	2.2 0.09	104.6	29.3	0.1252	1.66 3.66
36.098 1.4212	28.575 1.1250	-5.3 -0.21	3.5 0.14	90.0 3.54	96.0 3.78	3.3 0.13	133.0 5.24	125.0 4.92	3.4 0.13	1.9 0.08	125.7	32.0	0.1295	2.19 4.83
38.100 1.5000	31.750 1.2500	-4.8 -0.19	3.5 0.14	91.0 3.58	98.0 3.86	3.3 0.13	139.0 5.47	131.0 5.16	1.3 0.05	2.1 0.08	136.6	27.3	0.0919	2.69 5.94
46.672 1.8375	36.512 1.4375	-11.9 -0.47	5.0 0.20	91.0 3.58	101.0 3.98	3.3 0.13	142.0 5.59	134.0 5.28	1.8 0.07	1.3 0.05	159.6	26.3	0.0898	3.42 7.54
56.363 2.2190	41.275 1.6250	-18.5 -0.73	0.8 0.03	93.0 3.66	94.0 3.70	3.3 0.13	155.0 6.10	149.0 5.87	5.2 0.20	1.6 0.07	197.9	34.8	0.0937	5.53 12.18
15.083 0.5938	11.112 0.4375	1.5 0.06	1.5 0.06	87.0 3.43	90.0 3.54	1.5 0.06	110.0 4.33	108.0 4.25	0.2 0.01	2.1 0.09	66.2	60.0	0.0944	0.43 0.95
21.433 0.8438	16.670 0.6563	-1.3 -0.05	1.5 0.06	87.0 3.43	90.0 3.54	1.5 0.06	111.0 4.37	108.0 4.25	0.6 0.02	1.4 0.06	97.2	64.3	0.1079	0.66 1.45
25.400 1.0000	19.845 0.7813	0.5 0.02	3.5 0.14	89.0 3.50	96.0 3.78	1.5 0.06	120.0 4.72	115.0 4.53	1.5 0.06	1.7 0.07	98.2	41.8	0.1198	1.07 2.35

⁽⁴⁾Negative value indicates effective center inside cone (inner-ring) backface.

⁽⁵⁾These maximum fillet radii will be cleared by the bearing corners.

⁽⁶⁾Negative value indicates cage extends beyond cone (inner-ring) backface.

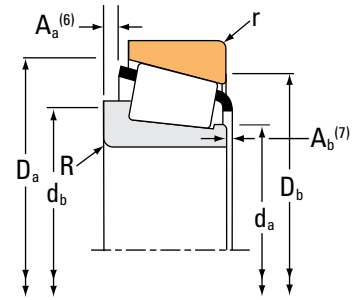
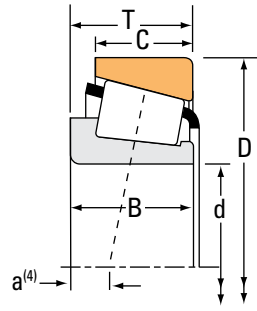
⁽⁷⁾Negative value indicates cage that does not extend beyond cone (inner-ring) front face.

Continued on next page.

TAPERED ROLLER BEARINGS

SINGLE-ROW • TYPE TS

TYPE TS



Bearing Dimensions			Load Ratings							Part Number			
Bore d	O.D. D	Width T	Dynamic ⁽¹⁾		Factors ⁽²⁾		Dynamic ⁽³⁾		Factors ⁽²⁾		Static C ₀	Inner	Outer
			C ₁	e	Y	C ₉₀	C _{a90}	K	N	N			
mm in.	mm in.	mm in.	N lbf			N lbf	N lbf		N lbf				
82.550 3.2500	133.350 5.2500	30.162 1.1875	154000 34700	0.44	1.35	40000 9000	30500 6850	1.31	216000 48600		495	492A	
82.550 3.2500	133.350 5.2500	33.338 1.3125	214000 48100	0.40	1.48	55500 12500	38400 8640	1.44	262000 58900		47686	47620	
82.550 3.2500	133.350 5.2500	33.338 1.3125	214000 48100	0.40	1.48	55500 12500	38400 8640	1.44	262000 58900		47685	47620	
82.550 3.2500	133.350 5.2500	33.338 1.3125	214000 48100	0.40	1.48	55500 12500	38400 8640	1.44	262000 58900		47687	47620	
82.550 3.2500	133.350 5.2500	39.688 1.5625	259000 58200	0.40	1.49	67100 15100	46200 10400	1.45	353000 79300		HM516448	HM516410	
82.550 3.2500	133.350 5.2500	39.688 1.5625	259000 58200	0.40	1.49	67100 15100	46200 10400	1.45	353000 79300		HM516449C	HM516410	
82.550 3.2500	133.350 5.2500	39.688 1.5625	259000 58200	0.40	1.49	67100 15100	46200 10400	1.45	353000 79300		HM516449A	HM516410	
82.550 3.2500	136.525 5.3750	30.162 1.1875	154000 34700	0.44	1.35	40000 9000	30500 6850	1.31	216000 48600		495	493	
82.550 3.2500	139.700 5.5000	36.512 1.4375	207000 46500	0.40	1.49	53600 12100	37100 8330	1.45	291000 65400		580	572X	
82.550 3.2500	139.700 5.5000	36.512 1.4375	207000 46500	0.40	1.49	53600 12100	37100 8330	1.45	291000 65400		582	572X	
82.550 3.2500	139.992 5.5115	36.512 1.4375	207000 46500	0.40	1.49	53600 12100	37100 8330	1.45	291000 65400		580	572	
82.550 3.2500	139.992 5.5115	36.512 1.4375	214000 48100	0.40	1.48	55500 12500	38400 8640	1.44	262000 58900		47685	47621	
82.550 3.2500	139.992 5.5115	36.512 1.4375	214000 48100	0.40	1.48	55500 12500	38400 8640	1.44	262000 58900		47686	47621	
82.550 3.2500	139.992 5.5115	36.512 1.4375	207000 46500	0.40	1.49	53600 12100	37100 8330	1.45	291000 65400		582	572	
82.550 3.2500	139.992 5.5115	36.512 1.4375	207000 46500	0.40	1.49	53600 12100	37100 8330	1.45	291000 65400		580	574	
82.550 3.2500	139.992 5.5115	36.512 1.4375	207000 46500	0.40	1.49	53600 12100	37100 8330	1.45	291000 65400		580X	572	
82.550 3.2500	142.138 5.5960	42.862 1.6875	261000 58700	0.43	1.39	67700 15200	50000 11300	1.35	399000 89700		HM617045	HM617010	

⁽¹⁾Based on 1 x 10⁶ revolutions L₁₀ life, for the ISO life-calculation method.

⁽²⁾Consult your Timken engineer for instructions on use or review the Timken Engineering Manual on timken.com/catalogs.

⁽³⁾Based on 90 x 10⁶ revolutions L₁₀ life, for The Timken Company life-calculation method. C₉₀ and C_{a90} are radial and thrust values.

Bearing Dimensions											Geometry Factors			Bearing Weight
Width B	Width C	Eff. Ctr. a ⁽⁴⁾	Shaft			Housing			Cage		G ₁	G ₂	C _g	
			Max Shaft Fillet Radius R ⁽⁵⁾	Backing Shoulder Dia. d _a	Backing Shoulder Dia. d _b	Max Housing Fillet Radius r ⁽⁵⁾	Backing Shoulder Dia. D _a	Backing Shoulder Dia. D _b	A _a ⁽⁶⁾	A _b ⁽⁷⁾				
mm in.	mm in.	mm in.	mm in.	mm in.	mm in.	mm in.	mm in.	mm in.	mm in.	mm in.				kg lbs.
29.769 1.1720	22.225 0.8750	-0.8 -0.03	3.5 0.14	90.0 3.54	97.0 3.82	3.3 0.13	128.0 5.04	120.0 4.72	2.5 0.09	2.2 0.09	104.6	29.3	0.1252	1.49 3.30
33.338 1.3125	26.195 1.0313	-4.3 -0.17	3.5 0.14	92.0 3.62	98.0 3.86	3.3 0.13	128.0 5.04	119.0 4.69	2.3 0.09	2.4 0.10	119.4	29.2	0.1273	1.71 3.76
33.338 1.3125	26.195 1.0313	-4.3 -0.17	0.8 0.03	90.0 3.54	91.0 3.58	3.3 0.13	128.0 5.04	119.0 4.69	2.3 0.09	2.4 0.10	119.4	29.2	0.1273	1.72 3.77
33.338 1.3125	26.195 1.0313	-4.3 -0.17	6.8 0.27	92.0 3.62	105.0 4.13	3.3 0.13	128.0 5.04	119.0 4.69	2.3 0.09	2.4 0.10	119.4	29.2	0.1273	1.70 3.73
39.688 1.5625	32.545 1.2813	-7.4 -0.29	6.8 0.27	92.0 3.62	106.0 4.17	3.3 0.13	128.0 5.04	118.0 4.65	1.7 0.06	2.5 0.10	154.1	43.1	0.0955	2.14 4.72
39.688 1.5625	32.545 1.2813	-7.4 -0.29	3.5 0.14	92.0 3.62	99.0 3.90	3.3 0.13	128.0 5.04	118.0 4.65	1.7 0.06	2.5 0.10	154.1	43.1	0.0955	2.15 4.74
39.688 1.5625	32.545 1.2813	-7.4 -0.29	0.0 0.00	92.0 3.62	99.0 4.13	3.3 0.13	128.0 5.04	118.0 4.65	1.7 0.06	2.5 0.10	154.1	43.1	0.0955	2.10 4.62
29.769 1.1720	22.225 0.8750	-0.8 -0.03	3.5 0.14	90.0 3.54	97.0 3.82	3.3 0.13	130.0 5.12	122.0 4.80	2.5 0.09	2.2 0.09	104.6	29.3	0.1252	1.61 3.55
36.098 1.4212	28.575 1.1250	-5.3 -0.21	3.5 0.14	91.0 3.58	98.0 3.86	3.3 0.13	133.0 5.24	125.0 4.92	3.4 0.13	1.9 0.08	125.7	32.0	0.1295	2.12 4.69
36.098 1.4212	28.575 1.1250	-5.3 -0.21	6.8 0.27	91.0 3.58	104.0 4.09	3.3 0.13	133.0 5.24	125.0 4.92	3.4 0.13	1.9 0.08	125.7	32.0	0.1295	2.08 4.59
36.098 1.4212	28.575 1.1250	-5.3 -0.21	3.5 0.14	91.0 3.58	98.0 3.86	3.3 0.13	133.0 5.24	125.0 4.92	3.4 0.13	1.9 0.08	125.7	32.0	0.1295	2.13 4.72
33.338 1.3125	29.370 1.1563	-4.3 -0.17	0.8 0.03	90.0 3.54	91.0 3.58	3.3 0.13	130.0 5.12	122.0 4.80	2.3 0.09	2.4 0.10	119.4	29.2	0.1273	2.13 4.70
33.338 1.3125	29.370 1.1563	-4.3 -0.17	3.5 0.14	92.0 3.62	98.0 3.86	3.3 0.13	130.0 5.12	122.0 4.80	2.3 0.09	2.4 0.10	119.4	29.2	0.1273	2.12 4.69
36.098 1.4212	28.575 1.1250	-5.3 -0.21	6.8 0.27	91.0 3.58	104.0 4.09	3.3 0.13	133.0 5.24	125.0 4.92	3.4 0.13	1.9 0.08	125.7	32.0	0.1295	2.09 4.62
36.098 1.4212	28.575 1.1250	-5.3 -0.21	3.5 0.14	91.0 3.58	98.0 3.86	0.5 0.02	133.0 5.24	128.0 5.04	3.4 0.13	1.9 0.08	125.7	32.0	0.1295	2.14 4.73
36.098 1.4212	28.575 1.1250	-5.3 -0.21	4.8 0.19	92.0 3.62	100.0 3.94	3.3 0.13	133.0 5.24	125.0 4.92	3.4 0.13	1.9 0.08	125.7	32.0	0.1295	2.12 4.68
42.862 1.6875	34.133 1.3438	-7.4 -0.29	3.5 0.14	95.0 3.74	101.0 3.98	3.3 0.13	137.0 5.39	125.0 4.92	3.2 0.12	2.4 0.10	162.9	38.9	0.0996	2.76 6.09

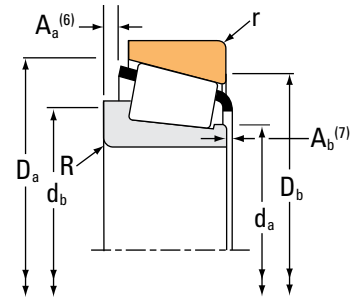
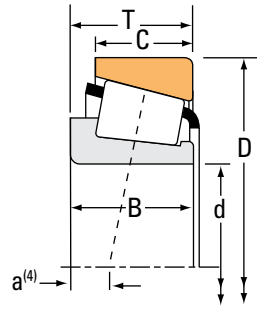
(4) Negative value indicates effective center inside cone (inner-ring) backface.
 (5) These maximum fillet radii will be cleared by the bearing corners.
 (6) Negative value indicates cage extends beyond cone (inner-ring) backface.
 (7) Negative value indicates cage that does not extend beyond cone (inner-ring) front face.

Continued on next page.

TAPERED ROLLER BEARINGS

SINGLE-ROW • TYPE TS

TYPE TS



Bearing Dimensions			Load Ratings							Part Number			
Bore d	O.D. D	Width T	Dynamic ⁽¹⁾		Factors ⁽²⁾		Dynamic ⁽³⁾		Factors ⁽²⁾		Static C ₀	Inner	Outer
			C ₁	e	Y	C ₉₀	C _{a90}	K	N	N			
mm in.	mm in.	mm in.	N lbf			N lbf	N lbf		N lbf				
82.550 3.2500	146.050 5.7500	41.275 1.6250	247000 55500	0.41	1.47	64000 14400	44800 10100	1.43	335000 75300		663	653	
82.550 3.2500	146.050 5.7500	41.275 1.6250	247000 55500	0.41	1.47	64000 14400	44800 10100	1.43	335000 75300		663A	653	
82.550 3.2500	147.638 5.8125	35.717 1.4062	216000 48600	0.44	1.36	56000 12600	42400 9530	1.32	319000 71600		595	592XS	
82.550 3.2500	147.638 5.8125	35.717 1.4062	216000 48600	0.44	1.36	56000 12600	42400 9530	1.32	319000 71600		595	592XE	
82.550 3.2500	150.000 5.9055	35.992 1.4170	216000 48600	0.44	1.36	56000 12600	42400 9530	1.32	319000 71600		595	593X	
82.550 3.2500	150.089 5.9090	44.450 1.7500	377000 84700	0.33	1.84	97600 21900	54400 12200	1.80	417000 93800		749A	742	
82.550 3.2500	150.089 5.9090	44.450 1.7500	377000 84700	0.33	1.84	97600 21900	54400 12200	1.80	417000 93800		750A	742	
82.550 3.2500	152.400 6.0000	35.717 1.4062	216000 48600	0.44	1.36	56000 12600	42400 9530	1.32	319000 71600		595	592AS	
82.550 3.2500	152.400 6.0000	39.688 1.5625	216000 48600	0.44	1.36	56000 12600	42400 9530	1.32	319000 71600		595	592A	
82.550 3.2500	152.400 6.0000	41.275 1.6250	247000 55500	0.41	1.47	64000 14400	44800 10100	1.43	335000 75300		663	652	
82.550 3.2500	159.995 6.2990	47.625 1.8750	327000 73600	0.34	1.76	84800 19100	49500 11100	1.71	441000 99200		757	752A	
82.550 3.2500	161.925 6.3750	47.625 1.8750	327000 73600	0.34	1.76	84800 19100	49500 11100	1.71	441000 99200		757	752	
82.550 3.2500	161.925 6.3750	53.975 2.1250	439000 98800	0.40	1.50	114000 25600	78100 17600	1.46	523000 118000		6559C	6535	
82.550 3.2500	168.275 6.6250	47.625 1.8750	327000 73600	0.34	1.76	84800 19100	49500 11100	1.71	441000 99200		757	753	
82.550 3.2500	168.275 6.6250	53.975 2.1250	409000 92000	0.30	2.00	106000 23800	54300 12200	1.95	522000 117000		839	832	
82.550 3.2500	168.275 6.6250	53.975 2.1250	485000 109000	0.30	2.00	126000 28300	64400 14500	1.95	522000 117000		842	832	
82.550 3.2500	180.975 7.1250	53.975 2.1250	448000 101000	0.73	0.82	116000 26100	146000 32700	0.80	458000 103000		H917849	H917810	

⁽¹⁾Based on 1 x 10⁶ revolutions L₁₀ life, for the ISO life-calculation method.

⁽²⁾Consult your Timken engineer for instructions on use or review the Timken Engineering Manual on timken.com/catalogs.

⁽³⁾Based on 90 x 10⁶ revolutions L₁₀ life, for The Timken Company life-calculation method. C₉₀ and C_{a90} are radial and thrust values.

Bearing Dimensions											Geometry Factors			Bearing Weight
Width B	Width C	Eff. Ctr. a ⁽⁴⁾	Shaft			Housing			Cage		G ₁	G ₂	C _g	
			Max Shaft Fillet Radius R ⁽⁵⁾	Backing Shoulder Dia. d _a d _b		Max Housing Fillet Radius r ⁽⁵⁾	Backing Shoulder Dia. D _a D _b		A _a ⁽⁶⁾	A _b ⁽⁷⁾				
mm in.	mm in.	mm in.	mm in.	mm in.	mm in.	mm in.	mm in.	mm in.	mm in.	mm in.				kg lbs.
41.275 1.6250	31.750 1.2500	-7.9 -0.31	3.5 0.14	92.0 3.62	99.0 3.90	3.3 0.13	139.0 5.47	131.0 5.16	4.5 0.17	2.1 0.08	136.6	27.3	0.0919	2.75 6.06
41.275 1.6250	31.750 1.2500	-7.9 -0.31	6.8 0.27	92.0 3.62	105.0 4.13	3.3 0.13	139.0 5.47	131.0 5.16	4.5 0.17	2.1 0.08	136.6	27.3	0.0919	2.74 6.03
36.322 1.4300	26.192 1.0312	-2.5 -0.10	3.5 0.14	93.0 3.66	100.0 3.94	3.3 0.13	142.0 5.59	133.0 5.24	4.1 0.16	1.7 0.07	151.4	38.3	0.1416	2.55 5.64
36.322 1.4300	26.192 1.0312	-2.5 -0.10	3.5 0.14	93.0 3.66	100.0 3.94	0.8 0.03	142.0 5.59	135.0 5.31	4.1 0.16	1.7 0.07	151.4	38.3	0.1416	2.57 5.68
36.322 1.4300	27.000 1.0630	-2.5 -0.10	3.5 0.14	93.0 3.66	100.0 3.94	3.0 0.12	142.0 5.59	134.0 5.28	4.1 0.16	1.7 0.07	151.4	38.3	0.1416	2.69 5.93
46.672 1.8375	36.512 1.4375	-11.9 -0.47	3.5 0.14	93.0 3.66	99.0 3.90	3.3 0.13	142.0 5.59	134.0 5.28	1.8 0.07	1.3 0.05	159.6	26.3	0.0898	3.36 7.40
46.672 1.8375	36.512 1.4375	-11.9 -0.47	6.5 0.26	93.0 3.66	106.0 4.17	3.3 0.13	142.0 5.59	134.0 5.28	1.8 0.07	1.3 0.05	159.6	26.3	0.0898	3.33 7.33
36.322 1.4300	26.192 1.0312	-2.5 -0.10	3.5 0.14	93.0 3.66	100.0 3.94	0.8 0.03	144.0 5.67	137.0 5.39	4.1 0.16	1.7 0.07	151.4	38.3	0.1416	2.81 6.19
36.322 1.4300	30.162 1.1875	-2.5 -0.10	3.5 0.14	93.0 3.66	100.0 3.94	3.3 0.13	144.0 5.67	135.0 5.31	4.1 0.16	1.7 0.07	151.4	38.3	0.1416	2.98 6.58
41.275 1.6250	31.750 1.2500	-7.9 -0.31	3.5 0.14	92.0 3.62	99.0 3.90	3.3 0.13	141.0 5.55	134.0 5.28	4.5 0.17	2.1 0.08	136.6	27.3	0.0919	3.10 6.85
48.260 1.9000	38.100 1.5000	-11.9 -0.47	3.5 0.14	94.0 3.70	100.0 3.94	0.8 0.03	150.0 5.91	146.0 5.75	3.2 0.12	1.0 0.04	177.2	29.4	0.0945	4.27 9.41
48.260 1.9000	38.100 1.5000	-11.9 -0.47	3.5 0.14	94.0 3.70	100.0 3.94	3.3 0.13	150.0 5.91	144.0 5.67	3.2 0.12	1.0 0.04	177.2	29.4	0.0945	4.39 9.69
55.100 2.1693	42.862 1.6875	-13.2 -0.52	3.5 0.14	98.0 3.86	104.0 4.09	3.3 0.13	154.0 6.06	141.0 5.55	4.1 0.16	0.9 0.04	198.6	33.5	0.1037	5.07 11.18
48.260 1.9000	38.100 1.5000	-11.9 -0.47	3.5 0.14	94.0 3.70	100.0 3.94	3.3 0.13	150.0 5.91	147.0 5.79	3.2 0.12	1.0 0.04	177.2	29.4	0.0945	4.86 10.73
56.363 2.2190	41.275 1.6250	-18.5 -0.73	0.8 0.03	94.0 3.70	95.0 3.74	3.3 0.13	155.0 6.10	149.0 5.87	5.2 0.20	1.6 0.07	197.9	34.8	0.0937	5.44 11.98
56.363 2.2190	41.275 1.6250	-18.5 -0.73	3.5 0.14	94.0 3.70	101.0 3.98	3.3 0.13	155.0 6.10	149.0 5.87	5.2 0.20	1.6 0.07	197.9	34.8	0.0937	5.42 11.95
53.183 2.0938	35.720 1.4063	0.5 0.02	3.3 0.13	100.1 3.94	114.0 4.49	3.3 0.13	170.0 6.69	152.0 5.98	9.5 0.37	2.8 0.11	147.0	20.7	0.1123	6.23 13.72

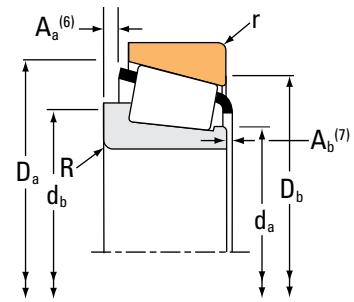
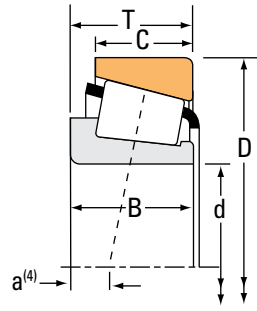
⁽⁴⁾Negative value indicates effective center inside cone (inner-ring) backface.
⁽⁵⁾These maximum fillet radii will be cleared by the bearing corners.
⁽⁶⁾Negative value indicates cage extends beyond cone (inner-ring) backface.
⁽⁷⁾Negative value indicates cage that does not extend beyond cone (inner-ring) front face.

Continued on next page.

TAPERED ROLLER BEARINGS

SINGLE-ROW • TYPE TS

TYPE TS



Bearing Dimensions			Load Ratings							Part Number		
Bore d	O.D. D	Width T	Dynamic ⁽¹⁾ C ₁		Factors ⁽²⁾ e Y		Dynamic ⁽³⁾ C ₉₀ C _{a90}		Factors ⁽²⁾ K	Static C ₀	Inner	Outer
mm in.	mm in.	mm in.	N lbf				N lbf	N lbf		N lbf		
83.345 3.2813	125.412 4.9375	25.400 1.0000	117000 26300	0.42	1.44		30400 6830	21600 4860	1.40	178000 39900	27690	27620
83.345 3.2813	125.412 4.9375	25.400 1.0000	117000 26300	0.42	1.44		30400 6830	21600 4860	1.40	178000 39900	27689	27620
83.345 3.2813	125.412 4.9375	25.400 1.0000	117000 26300	0.42	1.44		30400 6830	21600 4860	1.40	178000 39900	27691	27620
83.345 3.2813	133.350 5.2500	33.338 1.3125	214000 48100	0.40	1.48		55500 12500	38400 8640	1.44	262000 58900	47688	47620
84.138 3.3125	133.350 5.2500	30.162 1.1875	154000 34700	0.44	1.35		40000 9000	30500 6850	1.31	216000 48600	498	492A
84.138 3.3125	136.525 5.3750	30.162 1.1875	154000 34700	0.44	1.35		40000 9000	30500 6850	1.31	216000 48600	498	493
84.138 3.3125	152.400 6.0000	41.275 1.6250	247000 55500	0.41	1.47		64000 14400	44800 10100	1.43	335000 75300	664	652
84.138 3.3125	171.450 6.7500	49.212 1.9375	363000 81600	0.76	0.79		94100 21200	123000 27700	0.76	351000 78800	9386H	9321
84.138 3.3125	177.800 7.0000	52.388 2.0625	363000 81600	0.76	0.79		94100 21200	123000 27700	0.76	351000 78800	9386H	9320
84.975 3.3455	125.412 4.9375	25.400 1.0000	117000 26300	0.42	1.44		30400 6830	21600 4860	1.40	178000 39900	27695	27620
85.000 3.3465	130.000 5.1181	30.000 1.1811	161000 36300	0.44	1.35		41800 9400	31800 7150	1.31	245000 55100	JM716649	JM716610
85.000 3.3465	130.000 5.1181	30.000 1.1811	161000 36300	0.44	1.35		41800 9400	31800 7150	1.31	245000 55100	JM716648	JM716610
85.000 3.3465	140.000 5.5118	39.000 1.5354	282000 63300	0.41	1.47		73000 16400	50900 11400	1.43	339000 76300	JHM516849	JHM516810
85.000 3.3465	146.050 5.7500	41.275 1.6250	247000 55500	0.41	1.47		64000 14400	44800 10100	1.43	335000 75300	665X	653
85.000 3.3465	150.000 5.9055	41.275 1.6250	247000 55500	0.41	1.47		64000 14400	44800 10100	1.43	335000 75300	665X	653X
85.000 3.3465	150.000 5.9055	46.000 1.8110	393000 88400	0.33	1.80		102000 22900	58100 13100	1.76	446000 100000	JH217249	JH217210
85.000 3.3465	188.912 7.4375	53.297 2.0983	383000 86100	0.87	0.69		99300 22300	147000 33100	0.67	392000 88100	90334	90744

⁽¹⁾Based on 1 x 10⁶ revolutions L₁₀ life, for the ISO life-calculation method.

⁽²⁾Consult your Timken engineer for instructions on use or review the Timken Engineering Manual on timken.com/catalogs.

⁽³⁾Based on 90 x 10⁶ revolutions L₁₀ life, for The Timken Company life-calculation method. C₉₀ and C_{a90} are radial and thrust values.

Bearing Dimensions											Geometry Factors			Bearing Weight
Width B	Width C	Eff. Ctr. a ⁽⁴⁾	Shaft			Housing			Cage		G ₁	G ₂	C _g	
			Max Shaft Fillet Radius R ⁽⁵⁾	Backing Shoulder Dia. d _a	Shoulder Dia. d _b	Max Housing Fillet Radius r ⁽⁵⁾	Backing Shoulder Dia. D _a	Shoulder Dia. D _b	A _a ⁽⁶⁾	A _b ⁽⁷⁾				
mm in.	mm in.	mm in.	mm in.	mm in.	mm in.	mm in.	mm in.	mm in.	mm in.	mm in.				kg lbs.
25.400 1.0000	19.845 0.7813	0.5 0.02	3.5 0.14	89.0 3.50	96.0 3.78	1.5 0.06	120.0 4.72	115.0 4.53	1.5 0.06	1.7 0.07	98.2	41.8	0.1198	1.05 2.30
25.400 1.0000	19.845 0.7813	0.5 0.02	0.8 0.03	90.0 3.54	90.0 3.54	1.5 0.06	120.0 4.72	115.0 4.53	1.5 0.06	1.7 0.07	98.2	41.8	0.1198	1.05 2.32
25.400 1.0000	19.845 0.7813	0.5 0.02	6.4 0.25	90.0 3.54	102.0 4.02	1.5 0.06	120.0 4.72	115.0 4.53	1.5 0.06	1.7 0.07	98.2	41.8	0.1198	1.01 2.22
33.338 1.3125	26.195 1.0313	-4.3 -0.17	3.5 0.14	91.0 3.58	97.0 3.82	3.3 0.13	128.0 5.04	119.0 4.69	2.3 0.09	2.4 0.10	119.4	29.2	0.1273	1.68 3.69
29.769 1.1720	22.225 0.8750	-0.8 -0.03	3.5 0.14	91.0 3.58	98.0 3.86	3.3 0.13	128.0 5.04	120.0 4.72	2.5 0.09	2.2 0.09	104.6	29.3	0.1252	1.44 3.19
29.769 1.1720	22.225 0.8750	-0.8 -0.03	3.5 0.14	91.0 3.58	98.0 3.86	3.3 0.13	130.0 5.12	122.0 4.80	2.5 0.09	2.2 0.09	104.6	29.3	0.1252	1.56 3.45
41.275 1.6250	31.750 1.2500	-7.9 -0.31	3.5 0.14	94.0 3.70	100.0 3.94	3.3 0.13	141.0 5.55	134.0 5.28	4.5 0.17	2.1 0.08	136.6	27.3	0.0919	3.04 6.70
46.038 1.8125	31.750 1.2500	4.3 0.17	3.5 0.14	98.3 3.87	111.0 4.37	3.3 0.13	164.0 6.46	147.0 5.79	8.9 0.35	3.9 0.16	117.9	18.6	0.1053	4.70 10.36
46.038 1.8125	34.925 1.3750	4.3 0.17	3.5 0.14	98.3 3.87	111.0 4.37	3.3 0.13	164.0 6.46	148.0 5.83	8.9 0.35	3.9 0.16	117.9	18.6	0.1053	5.40 11.91
25.400 1.0000	19.845 0.7813	0.5 0.02	5.0 0.20	91.0 3.58	100.0 3.94	1.5 0.06	120.0 4.72	115.0 4.53	1.5 0.06	1.7 0.07	98.2	41.8	0.1198	0.98 2.16
29.000 1.1417	24.000 0.9449	-0.3 -0.01	3.0 0.12	92.0 3.62	98.0 3.86	2.5 0.10	125.0 4.92	117.0 4.61	2.0 0.08	2.6 0.10	117.1	38.4	0.1303	1.36 3.00
29.000 1.1417	24.000 0.9449	-0.3 -0.01	6.0 0.24	92.0 3.62	104.0 4.09	2.5 0.10	125.0 4.92	117.0 4.61	2.0 0.08	2.6 0.10	117.1	38.4	0.1303	1.32 2.91
38.000 1.4961	31.500 1.2402	-5.8 -0.23	3.0 0.12	94.0 3.70	100.0 3.94	2.5 0.10	134.0 5.28	125.0 4.92	1.4 0.05	3.6 0.14	140.9	35.2	0.0929	2.27 5.00
41.275 1.6250	31.750 1.2500	-7.9 -0.31	3.5 0.14	95.0 3.74	101.0 3.98	3.3 0.13	139.0 5.47	131.0 5.16	4.5 0.17	2.1 0.08	136.6	27.3	0.0919	2.65 5.83
41.275 1.6250	31.750 1.2500	-7.9 -0.31	3.5 0.14	95.0 3.74	101.0 3.98	3.0 0.12	141.0 5.55	133.0 5.24	4.5 0.17	2.1 0.08	136.6	27.3	0.0919	2.86 6.31
46.000 1.8110	38.000 1.4961	-11.9 -0.47	3.0 0.12	95.0 3.74	101.0 3.98	2.5 0.10	142.0 5.59	134.0 5.28	1.1 0.04	3.5 0.14	169.3	33.3	0.0924	3.34 7.36
52.761 2.0772	31.750 1.2500	10.4 0.41	3.5 0.14	112.0 4.41	116.0 4.57	3.3 0.13	179.0 7.06	161.0 6.34	13.5 0.53	-0.5 -0.02	149.6	23.8	0.1180	6.57 14.48

⁽⁴⁾Negative value indicates effective center inside cone (inner-ring) backface.

⁽⁵⁾These maximum fillet radii will be cleared by the bearing corners.

⁽⁶⁾Negative value indicates cage extends beyond cone (inner-ring) backface.

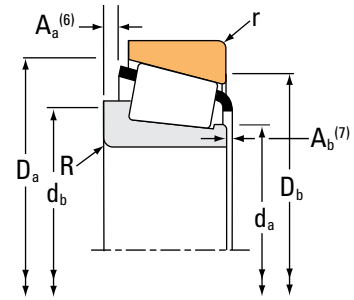
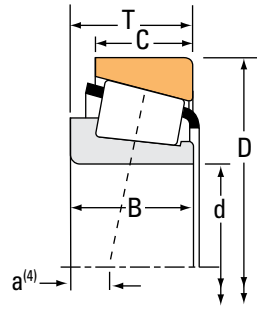
⁽⁷⁾Negative value indicates cage that does not extend beyond cone (inner-ring) front face.

Continued on next page.

TAPERED ROLLER BEARINGS

SINGLE-ROW • TYPE TS

TYPE TS



Bearing Dimensions			Load Ratings							Part Number		
Bore d	O.D. D	Width T	Dynamic ⁽¹⁾		Factors ⁽²⁾		Dynamic ⁽³⁾		Factors ⁽²⁾	Static	Inner	Outer
			C ₁	e	Y	C ₉₀	C _{a90}	K	C ₀			
mm in.	mm in.	mm in.	N lbf			N lbf	N lbf			N lbf		
85.000 3.3465	200.000 7.8740	52.761 2.0772	482000 108000	0.63	0.95	125000 28100	135000 30400	0.92		519000 117000	98335	98788
85.025 3.3475	150.000 5.9055	44.455 1.7502	377000 84700	0.33	1.84	97600 21900	54400 12200	1.80		417000 93800	749	743
85.025 3.3475	150.089 5.9090	44.450 1.7500	377000 84700	0.33	1.84	97600 21900	54400 12200	1.80		417000 93800	749	742
85.025 3.3475	150.089 5.9090	44.450 1.7500	377000 84700	0.33	1.84	97600 21900	54400 12200	1.80		417000 93800	749-S	742
85.725 3.3750	133.350 5.2500	30.162 1.1875	154000 34700	0.44	1.35	40000 9000	30500 6850	1.31		216000 48600	497	492A
85.725 3.3750	136.525 5.3750	30.162 1.1875	154000 34700	0.44	1.35	40000 9000	30500 6850	1.31		216000 48600	497	493
85.725 3.3750	136.525 5.3750	30.162 1.1875	154000 34700	0.44	1.35	40000 9000	30500 6850	1.31		216000 48600	497A	493
85.725 3.3750	142.138 5.5960	42.862 1.6875	261000 58700	0.43	1.39	67700 15200	50000 11300	1.35		399000 89700	HM617049	HM617010
85.725 3.3750	142.138 5.5960	42.862 1.6875	261000 58700	0.43	1.39	67700 15200	50000 11300	1.35		399000 89700	HM617048	HM617010
85.725 3.3750	146.050 5.7500	41.275 1.6250	247000 55500	0.41	1.47	64000 14400	44800 10100	1.43		335000 75300	665	653
85.725 3.3750	146.050 5.7500	41.275 1.6250	247000 55500	0.41	1.47	64000 14400	44800 10100	1.43		335000 75300	665A	653
85.725 3.3750	147.828 5.8200	35.717 1.4062	216000 48600	0.44	1.36	56000 12600	42400 9530	1.32		319000 71600	596	592AX
85.725 3.3750	150.000 5.9055	35.966 1.4160	216000 48600	0.44	1.36	56000 12600	42400 9530	1.32		319000 71600	596	JM719113
85.725 3.3750	150.000 5.9055	35.992 1.4170	216000 48600	0.44	1.36	56000 12600	42400 9530	1.32		319000 71600	596	593X
85.725 3.3750	152.400 6.0000	39.688 1.5625	216000 48600	0.44	1.36	56000 12600	42400 9530	1.32		319000 71600	596	592A
85.725 3.3750	152.400 6.0000	41.275 1.6250	247000 55500	0.41	1.47	64000 14400	44800 10100	1.43		335000 75300	665	652
85.725 3.3750	161.925 6.3750	47.625 1.8750	327000 73600	0.34	1.76	84800 19100	49500 11100	1.71		441000 99200	758	752

⁽¹⁾Based on 1×10^6 revolutions L_{10} life, for the ISO life-calculation method.

⁽²⁾Consult your Timken engineer for instructions on use or review the Timken Engineering Manual on timken.com/catalogs.

⁽³⁾Based on 90×10^6 revolutions L_{10} life, for The Timken Company life-calculation method. C_{90} and C_{a90} are radial and thrust values.

Bearing Dimensions											Geometry Factors			Bearing Weight
Width B	Width C	Eff. Ctr. a ⁽⁴⁾	Shaft			Housing			Cage		G ₁	G ₂	C _g	
			Max Shaft Fillet Radius R ⁽⁵⁾	Backing Shoulder Dia. d _a	mm in.	Max Housing Fillet Radius r ⁽⁵⁾	Backing Shoulder Dia. D _a	mm in.	A _a ⁽⁶⁾	A _b ⁽⁷⁾				
mm in.	mm in.	mm in.	mm in.	mm in.	mm in.	mm in.	mm in.	mm in.	mm in.	mm in.			kg lbs.	
49.212 1.9375	34.925 1.3750	1.3 0.05	3.5 0.14	109.0 4.29	115.0 4.53	3.3 0.13	188.0 7.40	174.0 6.85	8.6 0.34	5.4 0.22	203.4	37.5	0.1197	7.69 16.96
46.672 1.8375	35.000 1.3780	-11.9 -0.47	3.5 0.14	95.0 3.74	101.0 3.98	3.3 0.13	142.0 5.59	134.0 5.28	1.8 0.07	1.3 0.05	159.6	26.3	0.0898	3.21 7.06
46.672 1.8375	36.512 1.4375	-11.9 -0.47	3.5 0.14	95.0 3.74	101.0 3.98	3.3 0.13	142.0 5.59	134.0 5.28	1.8 0.07	1.3 0.05	159.6	26.3	0.0898	3.26 7.16
46.672 1.8375	36.512 1.4375	-11.9 -0.47	5.0 0.20	95.0 3.74	104.0 4.09	3.3 0.13	142.0 5.59	134.0 5.28	1.8 0.07	1.3 0.05	159.6	26.3	0.0898	3.23 7.11
29.769 1.1720	22.225 0.8750	-0.8 -0.03	3.5 0.14	93.0 3.66	99.0 3.90	3.3 0.13	128.0 5.04	120.0 4.72	2.5 0.09	2.2 0.09	104.6	29.3	0.1252	1.39 3.08
29.769 1.1720	22.225 0.8750	-0.8 -0.03	3.5 0.14	93.0 3.66	99.0 3.90	3.3 0.13	130.0 5.12	122.0 4.80	2.5 0.09	2.2 0.09	104.6	29.3	0.1252	1.51 3.34
29.769 1.1720	22.225 0.8750	-0.8 -0.03	6.4 0.25	93.0 3.66	105.0 4.13	3.3 0.13	130.0 5.12	122.0 4.80	2.5 0.09	2.2 0.09	104.6	29.3	0.1252	1.48 3.27
42.862 1.6875	34.133 1.3438	-7.4 -0.29	4.8 0.19	95.2 3.75	106.0 4.17	3.3 0.13	137.0 5.39	125.0 4.92	3.2 0.12	2.4 0.10	162.9	38.9	0.0996	2.61 5.75
42.862 1.6875	34.133 1.3438	-7.4 -0.29	1.5 0.06	95.2 3.75	99.0 3.90	3.3 0.13	137.0 5.39	125.0 4.92	3.2 0.12	2.4 0.10	162.9	38.9	0.0996	2.63 5.80
41.275 1.6250	31.750 1.2500	-7.9 -0.31	3.5 0.14	95.0 3.74	102.0 4.02	3.3 0.13	139.0 5.47	131.0 5.16	4.5 0.17	2.1 0.08	136.6	27.3	0.0919	2.61 5.75
41.275 1.6250	31.750 1.2500	-7.9 -0.31	6.4 0.25	95.0 3.74	107.0 4.21	3.3 0.13	139.0 5.47	131.0 5.16	4.5 0.17	2.1 0.08	136.6	27.3	0.0919	2.58 5.68
36.322 1.4300	26.192 1.0312	-2.5 -0.10	3.5 0.14	96.0 3.78	102.0 4.02	3.3 0.13	142.0 5.59	133.0 5.24	4.1 0.16	1.7 0.07	151.4	38.3	0.1416	2.47 5.45
36.322 1.4300	27.000 1.0630	-2.5 -0.10	3.5 0.14	96.0 3.78	102.0 4.02	2.5 0.10	143.0 5.63	135.0 5.31	4.1 0.16	1.7 0.07	151.4	38.3	0.1416	2.57 5.68
36.322 1.4300	27.000 1.0630	-2.5 -0.10	3.5 0.14	96.0 3.78	102.0 4.02	3.0 0.12	142.0 5.59	134.0 5.28	4.1 0.16	1.7 0.07	151.4	38.3	0.1416	2.57 5.67
36.322 1.4300	30.162 1.1875	-2.5 -0.10	3.5 0.14	96.0 3.78	102.0 4.02	3.3 0.13	144.0 5.67	135.0 5.31	4.1 0.16	1.7 0.07	151.4	38.3	0.1416	2.86 6.32
41.275 1.6250	31.750 1.2500	-7.9 -0.31	3.5 0.14	95.0 3.74	102.0 4.02	3.3 0.13	141.0 5.55	134.0 5.28	4.5 0.17	2.1 0.08	136.6	27.3	0.0919	2.96 6.54
48.260 1.9000	38.100 1.5000	-11.9 -0.47	3.5 0.14	100.0 3.94	106.0 4.17	3.3 0.13	150.0 5.91	144.0 5.67	3.2 0.12	1.0 0.04	177.2	29.4	0.0945	4.24 9.35

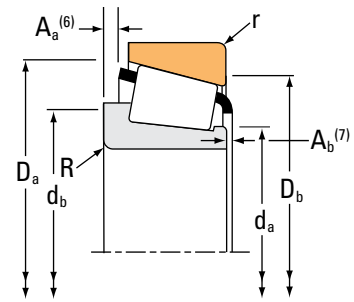
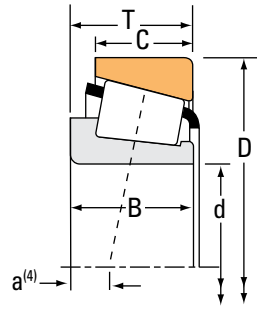
⁽⁴⁾Negative value indicates effective center inside cone (inner-ring) backface.
⁽⁵⁾These maximum fillet radii will be cleared by the bearing corners.
⁽⁶⁾Negative value indicates cage extends beyond cone (inner-ring) backface.
⁽⁷⁾Negative value indicates cage that does not extend beyond cone (inner-ring) front face.

Continued on next page.

TAPERED ROLLER BEARINGS

SINGLE-ROW • TYPE TS

TYPE TS



Bearing Dimensions			Load Ratings							Part Number			
Bore d	O.D. D	Width T	Dynamic ⁽¹⁾		Factors ⁽²⁾		Dynamic ⁽³⁾		Factors ⁽²⁾		Static C ₀	Inner	Outer
			C ₁	e	Y	C ₉₀	C _{a90}	K	N	N			
mm in.	mm in.	mm in.	N lbf			N lbf	N lbf		N lbf				
85.725 3.3750	168.275 6.6250	41.275 1.6250	265000 59500	0.47	1.28	68600 15400	55300 12400	1.24	386000 86700		677	672	
85.725 3.3750	168.275 6.6250	53.975 2.1250	485000 109000	0.30	2.00	126000 28300	64400 14500	1.95	522000 117000		841	832	
87.312 3.4375	123.825 4.8750	20.638 0.8125	92600 20800	0.33	1.82	24000 5400	13600 3050	1.77	156000 35200		L217847	L217810	
87.312 3.4375	152.400 6.0000	39.688 1.5625	216000 48600	0.44	1.36	56000 12600	42400 9530	1.32	319000 71600		596-S	592A	
87.312 3.4375	190.500 7.5000	57.150 2.2500	534000 120000	0.33	1.79	138000 31100	79300 17800	1.74	692000 156000		HH221432	HH221410	
87.960 3.4630	148.430 5.8437	28.575 1.1250	193000 43400	0.49	1.22	50100 11300	42200 9480	1.19	241000 54300		42346	42584	
87.960 3.4630	149.225 5.8750	31.750 1.2500	193000 43400	0.49	1.22	50100 11300	42200 9480	1.19	241000 54300		42346	42587	
88.900 3.5000	121.442 4.7812	15.083 0.5938	59500 13400	0.33	1.81	15400 3470	8730 1960	1.77	88700 20000		LL217849	LL217810	
88.900 3.5000	123.825 4.8750	20.638 0.8125	92600 20800	0.33	1.82	24000 5400	13600 3050	1.77	156000 35200		L217849	L217810	
88.900 3.5000	127.000 5.0000	20.638 0.8125	92600 20800	0.33	1.82	24000 5400	13600 3050	1.77	156000 35200		L217849	L217813	
88.900 3.5000	148.430 5.8437	28.575 1.1250	193000 43400	0.49	1.22	50100 11300	42200 9480	1.19	241000 54300		42350	42584	
88.900 3.5000	149.225 5.8750	31.750 1.2500	193000 43400	0.49	1.22	50100 11300	42200 9480	1.19	241000 54300		42350	42587	
88.900 3.5000	150.000 5.9055	35.966 1.4160	216000 48600	0.44	1.36	56000 12600	42400 9530	1.32	319000 71600		593A	JM719113	
88.900 3.5000	150.000 5.9055	35.966 1.4160	216000 48600	0.44	1.36	56000 12600	42400 9530	1.32	319000 71600		593	JM719113	
88.900 3.5000	150.000 5.9055	35.992 1.4170	216000 48600	0.44	1.36	56000 12600	42400 9530	1.32	319000 71600		593	593X	
88.900 3.5000	152.400 6.0000	39.688 1.5625	216000 48600	0.44	1.36	56000 12600	42400 9530	1.32	319000 71600		593	592A	
88.900 3.5000	152.400 6.0000	39.688 1.5625	216000 48600	0.44	1.36	56000 12600	42400 9530	1.32	319000 71600		593A	592A	

⁽¹⁾Based on 1 x 10⁶ revolutions L₁₀ life, for the ISO life-calculation method.

⁽²⁾Consult your Timken engineer for instructions on use or review the Timken Engineering Manual on timken.com/catalogs.

⁽³⁾Based on 90 x 10⁶ revolutions L₁₀ life, for The Timken Company life-calculation method. C₉₀ and C_{a90} are radial and thrust values.

Bearing Dimensions											Geometry Factors			Bearing Weight
Width B	Width C	Eff. Ctr. a ⁽⁴⁾	Shaft			Housing			Cage		G ₁	G ₂	C _g	
			Max Shaft Fillet Radius R ⁽⁵⁾	Backing Shoulder Dia. d _a	mm in.	Max Housing Fillet Radius r ⁽⁵⁾	Backing Shoulder Dia. D _a	mm in.	A _a ⁽⁶⁾	A _b ⁽⁷⁾				
mm in.	mm in.	mm in.	mm in.	mm in.	mm in.	mm in.	mm in.	mm in.	mm in.	mm in.			kg lbs.	
41.275 1.6250	30.162 1.1875	-2.8 -0.11	3.5 0.14	99.0 3.90	105.0 4.13	3.3 0.13	160.0 6.30	149.0 5.87	4.9 0.19	2.1 0.08	182.5	37.3	0.1056	4.14 9.11
56.363 2.2190	41.275 1.6250	-18.5 -0.73	3.5 0.14	97.0 3.82	104.0 4.09	3.3 0.13	155.0 6.10	149.0 5.87	5.2 0.20	1.6 0.07	197.9	34.8	0.0937	5.24 11.54
20.638 0.8125	16.670 0.6563	0.0 0.00	1.5 0.06	93.0 3.66	96.0 3.78	1.5 0.06	119.0 4.69	116.0 4.57	0.4 0.01	2.1 0.09	111.3	74.8	0.1152	0.78 1.70
36.322 1.4300	30.162 1.1875	-2.5 -0.10	3.5 0.14	97.0 3.82	103.0 4.06	3.3 0.13	144.0 5.67	135.0 5.31	4.1 0.16	1.7 0.07	151.4	38.3	0.1416	2.80 6.18
57.531 2.2650	46.038 1.8125	-15.0 -0.59	8.0 0.31	103.0 4.06	118.0 4.65	3.3 0.13	179.0 7.05	171.0 6.73	2.5 0.10	3.2 0.13	265.6	28.4	0.1072	7.90 17.41
28.971 1.1406	21.433 0.8438	3.0 0.12	3.0 0.12	98.0 3.86	103.0 4.06	3.0 0.12	142.0 5.59	134.0 5.28	2.8 0.11	3.0 0.12	129.7	37.2	0.1386	1.96 4.32
28.971 1.1406	24.608 0.9688	3.0 0.12	3.0 0.12	98.0 3.86	103.0 4.06	3.3 0.13	142.0 5.59	134.0 5.28	2.8 0.11	3.0 0.12	129.7	37.2	0.1386	2.11 4.66
15.083 0.5938	11.112 0.4375	3.0 0.12	1.5 0.06	94.0 3.70	97.0 3.82	1.5 0.06	117.0 4.61	115.0 4.53	0.4 0.01	2.1 0.08	73.4	74.1	0.0996	0.48 1.04
20.638 0.8125	16.670 0.6563	0.0 0.00	1.5 0.06	94.0 3.70	97.0 3.82	1.5 0.06	119.0 4.69	116.0 4.57	0.4 0.01	2.1 0.09	111.3	74.8	0.1152	0.74 1.63
20.638 0.8125	19.050 0.7500	0.0 0.00	1.5 0.06	94.0 3.70	97.0 3.82	1.5 0.06	121.0 4.76	117.0 4.61	0.4 0.01	2.1 0.09	111.3	74.8	0.1152	0.85 1.88
28.971 1.1406	21.433 0.8438	3.0 0.12	3.0 0.12	98.0 3.86	104.0 4.09	3.0 0.12	142.0 5.59	134.0 5.28	2.8 0.11	3.0 0.12	129.7	37.2	0.1386	1.93 4.25
28.971 1.1406	24.608 0.9688	3.0 0.12	3.0 0.12	98.0 3.86	104.0 4.09	3.3 0.13	142.0 5.59	134.0 5.28	2.8 0.11	3.0 0.12	129.7	37.2	0.1386	2.08 4.59
36.322 1.4300	27.000 1.0630	-2.5 -0.10	6.4 0.25	98.0 3.86	110.0 4.33	2.5 0.10	143.0 5.63	135.0 5.31	4.1 0.16	1.7 0.07	151.4	38.3	0.1416	2.42 5.34
36.322 1.4300	27.000 1.0630	-2.5 -0.10	3.5 0.14	98.0 3.86	104.0 4.09	2.5 0.10	143.0 5.63	135.0 5.31	4.1 0.16	1.7 0.07	151.4	38.3	0.1416	2.45 5.41
36.322 1.4300	27.000 1.0630	-2.5 -0.10	3.5 0.14	98.0 3.86	104.0 4.09	3.0 0.12	142.0 5.59	134.0 5.28	4.1 0.16	1.7 0.07	151.4	38.3	0.1416	2.45 5.40
36.322 1.4300	30.162 1.1875	-2.5 -0.10	3.5 0.14	98.0 3.86	104.0 4.09	3.3 0.13	144.0 5.67	135.0 5.31	4.1 0.16	1.7 0.07	151.4	38.3	0.1416	2.74 6.04
36.322 1.4300	30.162 1.1875	-2.5 -0.10	6.4 0.25	98.0 3.86	110.0 4.33	3.3 0.13	144.0 5.67	135.0 5.31	4.1 0.16	1.7 0.07	151.4	38.3	0.1416	2.71 5.97

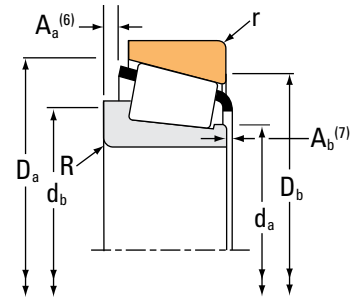
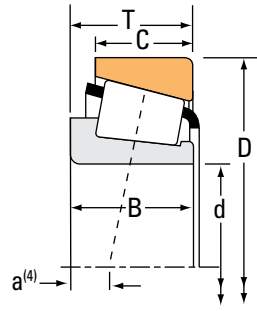
⁽⁴⁾Negative value indicates effective center inside cone (inner-ring) backface.
⁽⁵⁾These maximum fillet radii will be cleared by the bearing corners.
⁽⁶⁾Negative value indicates cage extends beyond cone (inner-ring) backface.
⁽⁷⁾Negative value indicates cage that does not extend beyond cone (inner-ring) front face.

Continued on next page.

TAPERED ROLLER BEARINGS

SINGLE-ROW • TYPE TS

TYPE TS



Bearing Dimensions			Load Ratings							Part Number		
Bore d	O.D. D	Width T	Dynamic ⁽¹⁾		Factors ⁽²⁾		Dynamic ⁽³⁾		Factors ⁽²⁾	Static	Inner	Outer
			C ₁	e	Y	C ₉₀	C _{a90}	K	C ₀			
mm in.	mm in.	mm in.	N lbf			N lbf	N lbf			N lbf		
88.900 3.5000	152.400 6.0000	39.688 1.5625	297000 66700	0.40	1.49	76900 17300	52900 11900	1.45	404000 90800		HM518445	HM518410
88.900 3.5000	159.995 6.2990	47.625 1.8750	327000 73600	0.34	1.76	84800 19100	49500 11100	1.71	441000 99200		759	752A
88.900 3.5000	160.000 6.2992	53.975 2.1250	439000 98800	0.40	1.50	114000 25600	78100 17600	1.46	523000 118000		6580	6525X
88.900 3.5000	161.925 6.3750	47.625 1.8750	327000 73600	0.34	1.76	84800 19100	49500 11100	1.71	441000 99200		759	752
88.900 3.5000	161.925 6.3750	47.625 1.8750	327000 73600	0.34	1.76	84800 19100	49500 11100	1.71	441000 99200		766	752
88.900 3.5000	161.925 6.3750	53.975 2.1250	439000 98800	0.40	1.50	114000 25600	78100 17600	1.46	523000 118000		6580	6535
88.900 3.5000	161.925 6.3750	53.975 2.1250	439000 98800	0.40	1.50	114000 25600	78100 17600	1.46	523000 118000		6580	6536
88.900 3.5000	168.275 6.6250	41.275 1.6250	265000 59500	0.47	1.28	68600 15400	55300 12400	1.24	386000 86700		679	672
88.900 3.5000	168.275 6.6250	47.625 1.8750	327000 73600	0.34	1.76	84800 19100	49500 11100	1.71	441000 99200		759	753
88.900 3.5000	168.275 6.6250	47.625 1.8750	327000 73600	0.34	1.76	84800 19100	49500 11100	1.71	441000 99200		766	753
88.900 3.5000	168.275 6.6250	53.975 2.1250	485000 109000	0.30	2.00	126000 28300	64400 14500	1.95	522000 117000		850	832
88.900 3.5000	171.450 6.7500	47.625 1.8750	340000 76400	0.37	1.63	88100 19800	55300 12400	1.59	474000 107000		77350	77675
88.900 3.5000	180.975 7.1250	47.625 1.8750	346000 77800	0.39	1.56	89700 20200	59200 13300	1.51	495000 111000		775	772
88.900 3.5000	190.500 7.5000	57.150 2.2500	458000 103000	0.33	1.79	119000 26700	68000 15300	1.74	630000 142000		855	854
88.900 3.5000	190.500 7.5000	57.150 2.2500	534000 120000	0.33	1.79	138000 31100	79300 17800	1.74	692000 156000		HH221434	HH221410
88.900 3.5000	200.000 7.8740	52.761 2.0772	482000 108000	0.63	0.95	125000 28100	135000 30400	0.92	519000 117000		98350	98788
89.090 3.5075	147.638 5.8125	35.717 1.4062	216000 48600	0.44	1.36	56000 12600	42400 9530	1.32	319000 71600		593-S	592XE

⁽¹⁾Based on 1 x 10⁶ revolutions L₁₀ life, for the ISO life-calculation method.

⁽²⁾Consult your Timken engineer for instructions on use or review the Timken Engineering Manual on timken.com/catalogs.

⁽³⁾Based on 90 x 10⁶ revolutions L₁₀ life, for The Timken Company life-calculation method. C₉₀ and C_{a90} are radial and thrust values.

Bearing Dimensions											Geometry Factors			Bearing Weight
Width B	Width C	Eff. Ctr. a ⁽⁴⁾	Shaft			Housing			Cage		G ₁	G ₂	C _g	
			Max Shaft Fillet Radius R ⁽⁵⁾	Backing Shoulder Dia. d _a d _b		Max Housing Fillet Radius r ⁽⁵⁾	Backing Shoulder Dia. D _a D _b		A _a ⁽⁶⁾	A _b ⁽⁷⁾				
mm in.	mm in.	mm in.	mm in.	mm in.	mm in.	mm in.	mm in.	mm in.	mm in.	mm in.				kg lbs.
39.688 1.5625	30.162 1.1875	-6.4 -0.25	6.4 0.25	100.0 3.94	112.0 4.41	3.3 0.13	147.0 5.79	137.0 5.39	3.2 0.12	3.6 0.14	161.5	33.7	0.0966	2.78 6.14
48.260 1.9000	38.100 1.5000	-11.9 -0.47	3.5 0.14	101.0 3.98	108.0 4.25	0.8 0.03	150.0 5.91	146.0 5.75	3.2 0.12	1.0 0.04	177.2	29.4	0.0945	3.96 8.71
55.100 2.1693	44.450 1.7500	-13.2 -0.52	3.5 0.14	102.0 4.02	117.0 4.61	3.0 0.12	153.4 6.04	141.0 5.55	4.1 0.16	0.9 0.04	198.6	33.5	0.1037	4.55 10.03
48.260 1.9000	38.100 1.5000	-11.9 -0.47	3.5 0.14	101.0 3.98	108.0 4.25	3.3 0.13	150.0 5.91	144.0 5.67	3.2 0.12	1.0 0.04	177.2	29.4	0.0945	4.08 8.99
48.260 1.9000	38.100 1.5000	-11.9 -0.47	7.0 0.28	99.0 3.90	113.0 4.45	3.3 0.13	150.0 5.91	144.0 5.67	3.2 0.12	1.0 0.04	177.2	29.4	0.0945	4.03 8.88
55.100 2.1693	42.862 1.6875	-13.2 -0.52	3.5 0.14	102.0 4.02	117.0 4.61	3.3 0.13	154.0 6.06	141.0 5.55	4.1 0.16	0.9 0.04	198.6	33.5	0.1037	4.70 10.36
55.100 2.1693	42.862 1.6875	-13.2 -0.52	3.5 0.14	102.0 4.02	117.0 4.61	0.8 0.03	154.0 6.06	144.0 5.67	4.1 0.16	0.9 0.04	198.6	33.5	0.1037	4.70 10.37
41.275 1.6250	30.162 1.1875	-2.8 -0.11	3.5 0.14	101.0 3.98	107.0 4.21	3.3 0.13	160.0 6.30	149.0 5.87	4.9 0.19	2.1 0.08	182.5	37.3	0.1056	4.00 8.80
48.260 1.9000	38.100 1.5000	-11.9 -0.47	3.5 0.14	101.0 3.98	108.0 4.25	3.3 0.13	150.0 5.91	147.0 5.79	3.2 0.12	1.0 0.04	177.2	29.4	0.0945	4.55 10.03
48.260 1.9000	38.100 1.5000	-11.9 -0.47	7.0 0.28	99.0 3.90	113.0 4.45	3.3 0.13	150.0 5.91	147.0 5.79	3.2 0.12	1.0 0.04	177.2	29.4	0.0945	4.50 9.92
56.363 2.2190	41.275 1.6250	-18.5 -0.73	3.5 0.14	100.0 3.94	106.0 4.17	3.3 0.13	155.0 6.10	149.0 5.87	5.2 0.20	1.6 0.07	197.9	34.8	0.0937	5.05 11.12
48.260 1.9000	38.100 1.5000	-9.7 -0.38	5.0 0.20	101.0 3.98	110.0 4.33	3.3 0.13	161.0 6.34	153.0 6.02	3.4 0.13	1.0 0.04	206.2	37.7	0.1017	4.87 10.75
48.006 1.8900	38.100 1.5000	-8.1 -0.32	4.8 0.19	103.0 4.06	112.0 4.41	3.3 0.13	168.0 6.61	161.0 6.34	3.6 0.14	1.3 0.05	227.3	41.3	0.1067	5.72 12.63
57.531 2.2650	44.450 1.7500	-15.2 -0.60	8.0 0.31	103.0 4.06	118.0 4.65	3.3 0.13	174.0 6.85	170.0 6.69	5.5 0.22	0.7 0.03	264.1	44.9	0.1072	7.65 16.87
57.531 2.2650	46.038 1.8125	-15.0 -0.59	8.0 0.31	105.0 4.13	120.0 4.72	3.3 0.13	179.0 7.05	171.0 6.73	2.5 0.10	3.2 0.13	265.6	28.4	0.1072	7.80 17.19
49.212 1.9375	34.925 1.3750	1.3 0.05	3.5 0.14	112.0 4.41	118.0 4.65	3.3 0.13	188.0 7.40	174.0 6.85	8.6 0.34	5.4 0.22	203.4	37.5	0.1197	7.49 16.51
36.322 1.4300	26.192 1.0312	-2.5 -0.10	3.5 0.14	98.0 3.86	105.0 4.13	0.8 0.03	142.0 5.59	135.0 5.31	4.1 0.16	1.7 0.07	151.4	38.3	0.1416	2.32 5.12

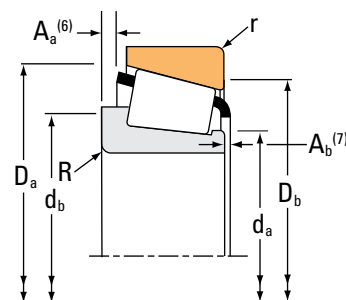
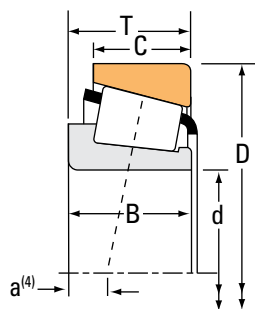
⁽⁴⁾Negative value indicates effective center inside cone (inner-ring) backface.
⁽⁵⁾These maximum fillet radii will be cleared by the bearing corners.
⁽⁶⁾Negative value indicates cage extends beyond cone (inner-ring) backface.
⁽⁷⁾Negative value indicates cage that does not extend beyond cone (inner-ring) front face.

Continued on next page.

TAPERED ROLLER BEARINGS

SINGLE-ROW • TYPE TS

TYPE TS



Bearing Dimensions			Load Ratings							Part Number		
Bore d	O.D. D	Width T	Dynamic ⁽¹⁾		Factors ⁽²⁾		Dynamic ⁽³⁾		Factors ⁽²⁾	Static	Inner	Outer
			C ₁	e	Y	C ₉₀	C _{a90}	K	C ₀			
mm in.	mm in.	mm in.	N lbf			N lbf	N lbf			N lbf		
89.090 3.5075	152.400 6.0000	39.688 1.5625	216000 48600	0.44	1.36	56000 12600	42400 9530	1.32		319000 71600	593-S	592A
89.891 3.5390	168.275 6.6250	53.975 2.1250	409000 92000	0.30	2.00	106000 23800	54300 12200	1.95		522000 117000	850A	832
89.975 3.5423	146.975 5.7864	40.000 1.5748	325000 73000	0.33	1.80	84200 18900	47900 10800	1.76		388000 87300	HM218248	HM218210
89.992 3.5430	160.096 6.3030	30.124 1.1860	181000 40600	0.42	1.42	46800 10500	33900 7620	1.38		230000 51700	69354	69630
90.000 3.5433	135.000 5.3150	24.000 0.9449	128000 28800	0.49	1.21	33300 7480	28100 6330	1.18		155000 34900	JP9049	JP9010
90.000 3.5433	145.000 5.7087	35.000 1.3780	222000 50000	0.44	1.35	57700 13000	43900 9860	1.31		313000 70500	JM718149	JM718110
90.000 3.5433	145.000 5.7087	35.000 1.3780	222000 50000	0.44	1.35	57700 13000	43900 9860	1.31		313000 70500	JM718149A	JM718110
90.000 3.5433	149.225 5.8750	31.750 1.2500	163000 36600	0.49	1.22	42200 9490	35600 8000	1.19		241000 54300	42354X	42587
90.000 3.5433	150.000 5.9055	35.992 1.4170	216000 48600	0.44	1.36	56000 12600	42400 9530	1.32		319000 71600	597X	593X
90.000 3.5433	152.400 6.0000	39.688 1.5625	216000 48600	0.44	1.36	56000 12600	42400 9530	1.32		319000 71600	597X	592A
90.000 3.5433	155.000 6.1024	44.000 1.7323	392000 88100	0.34	1.76	102000 22900	59400 13300	1.71		447000 101000	JHM318448	JHM318410
90.000 3.5433	160.000 6.2992	53.975 2.1250	439000 98800	0.40	1.50	114000 25600	78100 17600	1.46		523000 118000	6581X	6525X
90.000 3.5433	161.925 6.3750	53.975 2.1250	439000 98800	0.40	1.50	114000 25600	78100 17600	1.46		523000 118000	6581X	6535
90.000 3.5433	190.000 7.4803	50.800 2.0000	383000 86100	0.87	0.69	99300 22300	147000 33100	0.67		392000 88100	J90354	J90748
90.000 3.5433	190.000 7.4803	57.150 2.2500	534000 120000	0.33	1.79	138000 31100	79300 17800	1.74		692000 156000	JHH221436	JHH221413
90.488 3.5625	161.925 6.3750	47.625 1.8750	327000 73600	0.34	1.76	84800 19100	49500 11100	1.71		441000 99200	760	752
90.488 3.5625	168.275 6.6250	47.625 1.8750	327000 73600	0.34	1.76	84800 19100	49500 11100	1.71		441000 99200	760	753

⁽¹⁾Based on 1 x 10⁶ revolutions L₁₀ life, for the ISO life-calculation method.

⁽²⁾Consult your Timken engineer for instructions on use or review the Timken Engineering Manual on timken.com/catalogs.

⁽³⁾Based on 90 x 10⁶ revolutions L₁₀ life, for The Timken Company life-calculation method. C₉₀ and C_{a90} are radial and thrust values.

Bearing Dimensions											Geometry Factors			Bearing Weight
Width B	Width C	Eff. Ctr. a ⁽⁴⁾	Shaft			Housing			Cage		G ₁	G ₂	C _g	
			Max Shaft Fillet Radius R ⁽⁵⁾	Backing Shoulder Dia. d _a	mm in.	Max Housing Fillet Radius r ⁽⁵⁾	Backing Shoulder Dia. D _a	mm in.	A _a ⁽⁶⁾	A _b ⁽⁷⁾				
mm in.	mm in.	mm in.	mm in.	mm in.	mm in.	mm in.	mm in.	mm in.	mm in.	mm in.			kg lbs.	
36.322 1.4300	30.162 1.1875	-2.5 -0.10	3.5 0.14	98.0 3.86	105.0 4.13	3.3 0.13	144.0 5.67	135.0 5.31	4.1 0.16	1.7 0.07	151.4	38.3	0.1416	2.73 6.03
56.363 2.2190	41.275 1.6250	-18.5 -0.73	3.5 0.14	101.0 3.98	107.0 4.21	3.3 0.13	155.0 6.10	149.0 5.87	5.2 0.20	1.6 0.07	197.9	34.8	0.0937	4.98 10.98
40.000 1.5748	32.500 1.2795	-8.6 -0.34	7.0 0.28	99.0 3.90	112.0 4.41	3.5 0.14	141.0 5.55	133.0 5.24	1.4 0.05	3.0 0.12	168.2	34.7	0.0921	2.52 5.56
30.162 1.1875	22.300 0.8780	-0.5 -0.02	2.3 0.09	99.0 3.90	103.0 4.06	3.3 0.13	149.0 5.87	143.0 5.63	3.7 0.14	2.5 0.10	116.8	39.6	0.0874	2.36 5.20
22.500 0.8858	17.500 0.6890	5.6 0.22	2.0 0.08	97.0 3.82	100.0 3.94	2.0 0.08	130.0 5.12	125.0 4.92	1.8 0.07	3.3 0.13	83.8	46.1	0.1196	1.08 2.38
34.000 1.3386	27.000 1.0630	-2.0 -0.08	3.0 0.12	99.0 3.90	106.0 4.17	2.5 0.10	138.8 5.46	131.0 5.16	2.1 0.08	3.9 0.16	138.0	34.9	0.0946	2.14 4.72
34.000 1.3386	27.000 1.0630	-2.0 -0.08	6.0 0.24	99.0 3.90	112.0 4.41	2.5 0.10	138.8 5.46	131.0 5.16	2.1 0.08	3.9 0.16	138.0	34.9	0.0946	2.13 4.69
28.971 1.1406	24.608 0.9688	3.0 0.12	3.0 0.12	99.0 3.90	104.0 4.09	3.3 0.13	142.0 5.59	134.0 5.28	2.8 0.11	3.0 0.12	129.7	37.2	0.1386	2.05 4.52
36.322 1.4300	27.000 1.0630	-2.5 -0.10	3.0 0.12	99.0 3.90	104.0 4.09	3.0 0.12	142.0 5.59	134.0 5.28	4.1 0.16	1.7 0.07	151.4	38.3	0.1416	2.41 5.31
36.322 1.4300	30.162 1.1875	-2.5 -0.10	3.0 0.12	99.0 3.90	104.0 4.09	3.3 0.13	144.0 5.67	135.0 5.31	4.1 0.16	1.7 0.07	151.4	38.3	0.1416	2.70 5.96
44.000 1.7323	35.500 1.3976	-9.9 -0.39	3.0 0.12	100.0 3.94	106.0 4.17	2.5 0.10	148.0 5.83	140.0 5.51	1.3 0.05	3.3 0.13	178.9	32.4	0.0948	3.33 7.32
55.100 2.1693	44.450 1.7500	-13.2 -0.52	3.0 0.12	102.0 4.02	109.0 4.29	3.0 0.12	153.4 6.04	141.0 5.55	4.1 0.16	0.9 0.04	198.6	33.5	0.1037	4.49 9.89
55.100 2.1693	42.862 1.6875	-13.2 -0.52	3.0 0.12	102.0 4.02	109.0 4.29	3.3 0.13	154.0 6.06	141.0 5.55	4.1 0.16	0.9 0.04	198.6	33.5	0.1037	4.64 10.22
46.038 1.8125	31.750 1.2500	12.7 0.50	3.5 0.14	111.8 4.40	120.0 4.72	3.3 0.13	179.3 7.06	162.0 6.38	11.0 0.43	3.7 0.15	149.6	23.8	0.1180	6.03 13.31
57.531 2.2650	46.038 1.8125	-15.0 -0.59	8.0 0.31	106.0 4.17	121.0 4.76	3.3 0.13	179.0 7.05	171.0 6.73	2.5 0.10	3.2 0.13	265.6	28.4	0.1072	7.65 16.87
48.260 1.9000	38.100 1.5000	-11.9 -0.47	3.5 0.14	101.0 3.98	110.0 4.33	3.3 0.13	150.0 5.91	144.0 5.67	3.2 0.12	1.0 0.04	177.2	29.4	0.0945	3.99 8.80
48.260 1.9000	38.100 1.5000	-11.9 -0.47	3.5 0.14	101.0 3.98	110.0 4.33	3.3 0.13	150.0 5.91	147.0 5.79	3.2 0.12	1.0 0.04	177.2	29.4	0.0945	4.46 9.84

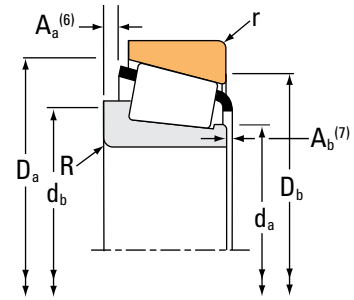
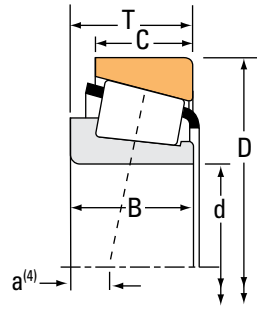
(4) Negative value indicates effective center inside cone (inner-ring) backface.
 (5) These maximum fillet radii will be cleared by the bearing corners.
 (6) Negative value indicates cage extends beyond cone (inner-ring) backface.
 (7) Negative value indicates cage that does not extend beyond cone (inner-ring) front face.

Continued on next page.

TAPERED ROLLER BEARINGS

SINGLE-ROW • TYPE TS

TYPE TS



Bearing Dimensions			Load Ratings							Part Number			
Bore d	O.D. D	Width T	Dynamic ⁽¹⁾		Factors ⁽²⁾		Dynamic ⁽³⁾		Factors ⁽²⁾		Static C ₀	Inner	Outer
			C ₁	e	Y	C ₉₀	C _{a90}	K	N	N			
mm in.	mm in.	mm in.	N lbf			N lbf	N lbf		N lbf				
91.973 3.6210	142.875 5.6250	30.000 1.1811	164000 36800	0.48	1.25	42400 9540	34700 7810	1.22	240000 53900		LM718947	LM718910	
92.075 3.6250	130.175 5.1250	20.638 0.8125	95400 21400	0.35	1.72	24700 5560	14800 3320	1.67	166000 37400		L319245	L319210	
92.075 3.6250	146.050 5.7500	33.338 1.3125	197000 44300	0.45	1.34	51100 11500	39200 8810	1.30	307000 69000		47890	47820	
92.075 3.6250	147.638 5.8125	35.717 1.4062	216000 48600	0.44	1.36	56000 12600	42400 9530	1.32	319000 71600		598	592XS	
92.075 3.6250	147.638 5.8125	35.717 1.4062	216000 48600	0.44	1.36	56000 12600	42400 9530	1.32	319000 71600		598	592XE	
92.075 3.6250	148.430 5.8437	28.575 1.1250	163000 36600	0.49	1.22	42200 9490	35600 8000	1.19	241000 54300		42362	42584	
92.075 3.6250	149.225 5.8750	31.750 1.2500	163000 36600	0.49	1.22	42200 9490	35600 8000	1.19	241000 54300		42362	42587	
92.075 3.6250	150.000 5.9055	35.966 1.4160	216000 48600	0.44	1.36	56000 12600	42400 9530	1.32	319000 71600		598	JM719113	
92.075 3.6250	152.400 6.0000	39.688 1.5625	216000 48600	0.44	1.36	56000 12600	42400 9530	1.32	319000 71600		598	592A	
92.075 3.6250	152.400 6.0000	39.688 1.5625	216000 48600	0.44	1.36	56000 12600	42400 9530	1.32	319000 71600		598A	592A	
92.075 3.6250	152.400 6.0000	39.688 1.5625	216000 48600	0.44	1.36	56000 12600	42400 9530	1.32	319000 71600		598	592-S	
92.075 3.6250	152.400 6.0000	39.688 1.5625	216000 48600	0.44	1.36	56000 12600	42400 9530	1.32	319000 71600		598X	592A	
92.075 3.6250	168.275 6.6250	41.275 1.6250	265000 59500	0.47	1.28	68600 15400	55300 12400	1.24	386000 86700		681	672	
92.075 3.6250	168.275 6.6250	41.275 1.6250	265000 59500	0.47	1.28	68600 15400	55300 12400	1.24	386000 86700		681A	672	
92.075 3.6250	171.450 6.7500	47.625 1.8750	340000 76400	0.37	1.63	88100 19800	55300 12400	1.59	474000 107000		77362	77675	
92.075 3.6250	171.450 6.7500	47.625 1.8750	340000 76400	0.37	1.63	88100 19800	55300 12400	1.59	474000 107000		77364	77675	
92.075 3.6250	180.975 7.1250	47.625 1.8750	346000 77800	0.39	1.56	89700 20200	59200 13300	1.51	495000 111000		778	772	

⁽¹⁾Based on 1×10^6 revolutions L_{10} life, for the ISO life-calculation method.

⁽²⁾Consult your Timken engineer for instructions on use or review the Timken Engineering Manual on timken.com/catalogs.

⁽³⁾Based on 90×10^6 revolutions L_{10} life, for The Timken Company life-calculation method. C_{90} and C_{a90} are radial and thrust values.

Bearing Dimensions											Geometry Factors			Bearing Weight
Width B	Width C	Eff. Ctr. a ⁽⁴⁾	Shaft			Housing			Cage		G ₁	G ₂	C _g	
			Max Shaft Fillet Radius R ⁽⁵⁾	Backing Shoulder Dia. d _a	Shoulder Dia. d _b	Max Housing Fillet Radius r ⁽⁵⁾	Backing Shoulder Dia. D _a	Shoulder Dia. D _b	A _a ⁽⁶⁾	A _b ⁽⁷⁾				
mm in.	mm in.	mm in.	mm in.	mm in.	mm in.	mm in.	mm in.	mm in.	mm in.	mm in.				kg lbs.
30.000 1.1811	22.000 0.8661	1.8 0.07	3.5 0.14	100.0 3.94	106.0 4.17	3.3 0.13	138.0 5.43	129.0 5.08	2.7 0.10	2.0 0.08	124.2	37.6	0.1355	1.63 3.60
21.433 0.8438	16.670 0.6563	1.3 0.05	3.5 0.14	99.0 3.90	105.0 4.13	1.5 0.06	125.0 4.92	122.0 4.80	0.6 0.02	1.4 0.06	125.3	90.8	0.1220	0.86 1.88
34.925 1.3750	26.195 1.0313	-1.0 -0.04	3.5 0.14	101.0 3.98	107.0 4.21	3.3 0.13	140.0 5.51	131.0 5.16	2.5 0.10	0.3 0.02	153.2	38.1	0.1428	2.06 4.54
36.322 1.4300	26.192 1.0312	-2.5 -0.10	3.5 0.14	101.0 3.98	107.0 4.21	3.3 0.13	142.0 5.59	133.0 5.24	4.1 0.16	1.7 0.07	151.4	38.3	0.1416	2.18 4.82
36.322 1.4300	26.192 1.0312	-2.5 -0.10	3.5 0.14	101.0 3.98	107.0 4.21	0.8 0.03	142.0 5.59	135.0 5.31	4.1 0.16	1.7 0.07	151.4	38.3	0.1416	2.20 4.86
28.971 1.1406	21.433 0.8438	3.0 0.12	3.5 0.14	101.0 3.98	107.0 4.21	3.0 0.12	142.0 5.59	134.0 5.28	2.8 0.11	3.0 0.12	129.7	37.2	0.1386	1.83 4.02
28.971 1.1406	24.608 0.9688	3.0 0.12	3.5 0.14	101.0 3.98	107.0 4.21	3.3 0.13	142.0 5.59	134.0 5.28	2.8 0.11	3.0 0.12	129.7	37.2	0.1386	1.98 4.36
36.322 1.4300	27.000 1.0630	-2.5 -0.10	3.5 0.14	101.0 3.98	107.0 4.21	2.5 0.10	143.0 5.63	135.0 5.31	4.1 0.16	1.7 0.07	151.4	38.3	0.1416	2.32 5.12
36.322 1.4300	30.162 1.1875	-2.5 -0.10	3.5 0.14	101.0 3.98	107.0 4.21	3.3 0.13	144.0 5.67	135.0 5.31	4.1 0.16	1.7 0.07	151.4	38.3	0.1416	2.61 5.76
36.322 1.4300	30.162 1.1875	-2.5 -0.10	6.4 0.25	101.0 3.98	113.0 4.45	3.3 0.13	144.0 5.67	135.0 5.31	4.1 0.16	1.7 0.07	151.4	38.3	0.1416	2.58 5.69
36.322 1.4300	39.688 1.5625	-2.5 -0.10	3.5 0.14	101.0 3.98	107.0 4.21	3.3 0.13	147.0 5.79	135.0 5.31	4.1 0.16	1.7 0.07	151.4	38.3	0.1416	2.75 6.06
36.322 1.4300	30.162 1.1875	-2.5 -0.10	3.5 0.14	104.0 4.09	107.0 4.21	3.3 0.13	144.0 5.67	135.0 5.31	4.1 0.16	1.7 0.07	151.4	38.3	0.1416	2.61 5.75
41.275 1.6250	30.162 1.1875	-2.8 -0.11	3.5 0.14	104.0 4.09	110.0 4.33	3.3 0.13	160.0 6.30	149.0 5.87	4.9 0.19	2.1 0.08	182.5	37.3	0.1056	3.85 8.48
41.275 1.6250	30.162 1.1875	-2.8 -0.11	6.4 0.25	104.0 4.09	116.0 4.57	3.3 0.13	160.0 6.30	149.0 5.87	4.9 0.19	2.1 0.08	182.5	37.3	0.1056	3.82 8.41
48.260 1.9000	38.100 1.5000	-9.7 -0.38	3.5 0.14	103.0 4.06	109.0 4.29	3.3 0.13	161.0 6.34	153.0 6.02	3.4 0.13	1.0 0.04	206.2	37.7	0.1017	4.72 10.41
48.260 1.9000	38.100 1.5000	-9.7 -0.38	6.4 0.25	103.0 4.06	115.0 4.53	3.3 0.13	161.0 6.34	153.0 6.02	3.4 0.13	1.0 0.04	206.2	37.7	0.1017	4.68 10.33
48.006 1.8900	38.100 1.5000	-8.1 -0.32	3.5 0.14	105.0 4.13	111.0 4.37	3.3 0.13	168.0 6.61	161.0 6.34	3.6 0.14	1.3 0.05	227.3	41.3	0.1067	5.57 12.28

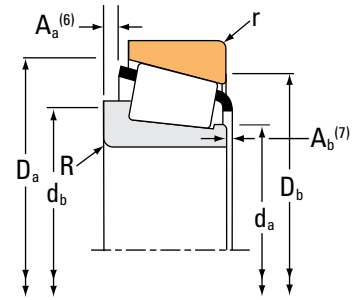
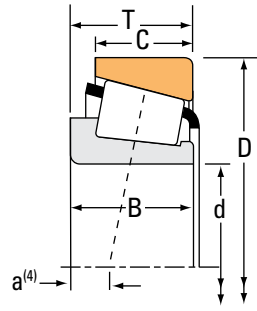
(4) Negative value indicates effective center inside cone (inner-ring) backface.
 (5) These maximum fillet radii will be cleared by the bearing corners.
 (6) Negative value indicates cage extends beyond cone (inner-ring) backface.
 (7) Negative value indicates cage that does not extend beyond cone (inner-ring) front face.

Continued on next page.

TAPERED ROLLER BEARINGS

SINGLE-ROW • TYPE TS

TYPE TS



Bearing Dimensions			Load Ratings							Part Number			
Bore d	O.D. D	Width T	Dynamic ⁽¹⁾		Factors ⁽²⁾		Dynamic ⁽³⁾		Factors ⁽²⁾		Static C ₀	Inner	Outer
			C ₁	e	Y	C ₉₀	C _{a90}	K	N	N			
mm in.	mm in.	mm in.	N lbf			N lbf	N lbf		N lbf				
92.075 3.6250	190.500 7.5000	57.150 2.2500	458000 103000	0.33	1.79	119000 26700	68000 15300	1.74	630000 142000		857	854	
92.075 3.6250	190.500 7.5000	57.150 2.2500	534000 120000	0.33	1.79	138000 31100	79300 17800	1.74	692000 156000		HH221438	HH221410	
92.075 3.6250	214.312 8.4375	73.025 2.8750	644000 145000	0.46	1.31	167000 37500	131000 29500	1.27	786000 177000		EE213362	213843	
93.662 3.6875	148.430 5.8437	28.575 1.1250	193000 43400	0.49	1.22	50100 11300	42200 9480	1.19	241000 54300		42368	42584	
93.662 3.6875	149.225 5.8750	31.750 1.2500	193000 43400	0.49	1.22	50100 11300	42200 9480	1.19	241000 54300		42368	42587	
93.662 3.6875	152.400 6.0000	39.688 1.5625	216000 48600	0.44	1.36	56000 12600	42400 9530	1.32	319000 71600		597	592A	
94.975 3.7392	149.975 5.9045	31.750 1.2500	163000 36600	0.49	1.22	42200 9490	35600 8000	1.19	241000 54300		42373	42590	
94.975 3.7392	168.275 6.6250	41.275 1.6250	265000 59500	0.47	1.28	68600 15400	55300 12400	1.24	386000 86700		682	672	
95.000 3.7402	135.000 5.3150	20.000 0.7874	98400 22100	0.58	1.03	25500 5740	25500 5730	1.00	133000 29900		JL819349	JL819310	
95.000 3.7402	145.000 5.7087	24.000 0.9449	125000 28200	0.47	1.27	32500 7310	26300 5920	1.24	172000 38700		JP10044	JP10010	
95.000 3.7402	150.000 5.9055	35.000 1.3780	215000 48300	0.44	1.36	55700 12500	42100 9470	1.32	316000 71100		JM719149	JM719113	
95.000 3.7402	152.400 6.0000	39.688 1.5625	216000 48600	0.44	1.36	56000 12600	42400 9530	1.32	319000 71600		J594X	592A	
95.000 3.7402	160.000 6.2992	46.000 1.8110	354000 79700	0.34	1.77	91900 20700	53200 12000	1.73	506000 114000		JF9549	JF9510	
95.000 3.7402	190.000 7.4803	57.000 2.2441	458000 103000	0.33	1.79	119000 26700	68000 15300	1.74	630000 142000		862	853	
95.250 3.7500	130.175 5.1250	20.638 0.8125	95400 21400	0.35	1.72	24700 5560	14800 3320	1.67	166000 37400		L319249	L319210	
95.250 3.7500	136.525 5.3750	30.162 1.1875	140000 31400	0.28	2.11	36200 8140	17600 3950	2.06	227000 51100		LM119348	LM119311	
95.250 3.7500	146.050 5.7500	33.338 1.3125	197000 44300	0.45	1.34	51100 11500	39200 8810	1.30	307000 69000		47896	47820	

⁽¹⁾Based on 1 x 10⁶ revolutions L₁₀ life, for the ISO life-calculation method.

⁽²⁾Consult your Timken engineer for instructions on use or review the Timken Engineering Manual on timken.com/catalogs.

⁽³⁾Based on 90 x 10⁶ revolutions L₁₀ life, for The Timken Company life-calculation method. C₉₀ and C_{a90} are radial and thrust values.

Bearing Dimensions											Geometry Factors			Bearing Weight
Width B	Width C	Eff. Ctr. a ⁽⁴⁾	Shaft			Housing			Cage		G ₁	G ₂	C _g	
			Max Shaft Fillet Radius R ⁽⁵⁾	Backing Shoulder Dia. d _a	Shoulder Dia. d _b	Max Housing Fillet Radius r ⁽⁵⁾	Backing Shoulder Dia. D _a	Shoulder Dia. D _b	A _a ⁽⁶⁾	A _b ⁽⁷⁾				
mm in.	mm in.	mm in.	mm in.	mm in.	mm in.	mm in.	mm in.	mm in.	mm in.	mm in.				kg lbs.
57.531 2.2650	44.450 1.7500	-15.2 -0.60	8.0 0.31	106.0 4.17	121.0 4.76	3.3 0.13	174.0 6.85	170.0 6.69	5.5 0.22	0.7 0.03	264.1	44.9	0.1072	7.44 16.42
57.531 2.2650	46.038 1.8125	-15.0 -0.59	8.0 0.31	107.0 4.21	122.0 4.80	3.3 0.13	179.0 7.05	171.0 6.73	2.5 0.10	3.2 0.13	265.6	28.4	0.1072	7.59 16.73
73.025 2.8750	53.975 2.1250	-18.3 -0.72	9.7 0.38	117.0 4.61	135.0 5.31	6.4 0.25	195.8 7.71	182.0 7.17	9.9 0.39	3.6 0.14	262.4	38.1	0.1180	12.38 27.28
28.971 1.1406	21.433 0.8438	3.0 0.12	3.0 0.12	102.0 4.02	107.0 4.21	3.0 0.12	142.0 5.59	134.0 5.28	2.8 0.11	3.0 0.12	129.7	37.2	0.1386	1.78 3.91
28.971 1.1406	24.608 0.9688	3.0 0.12	3.0 0.12	102.0 4.02	107.0 4.21	3.3 0.13	142.0 5.59	134.0 5.28	2.8 0.11	3.0 0.12	129.7	37.2	0.1386	1.93 4.25
36.322 1.4300	30.162 1.1875	-2.5 -0.10	3.5 0.14	102.0 4.02	109.0 4.29	3.3 0.13	144.0 5.67	135.0 5.31	4.1 0.16	1.7 0.07	151.4	38.3	0.1416	2.54 5.61
28.971 1.1406	24.608 0.9688	3.0 0.12	3.0 0.12	103.0 4.06	108.0 4.25	3.3 0.13	143.0 5.63	135.0 5.31	2.8 0.11	3.0 0.12	129.7	37.2	0.1386	1.93 4.25
41.275 1.6250	30.162 1.1875	-2.8 -0.11	3.5 0.14	106.0 4.17	113.0 4.45	3.3 0.13	160.0 6.30	149.0 5.87	4.9 0.19	2.1 0.08	182.5	37.3	0.1056	3.71 8.18
20.000 0.7874	14.000 0.5512	10.9 0.43	5.0 0.20	102.0 4.02	111.0 4.37	2.5 0.10	129.0 5.08	123.0 4.84	2.4 0.09	1.4 0.06	93.3	70.6	0.1298	0.85 1.88
22.500 0.8858	17.500 0.6890	6.1 0.24	3.0 0.12	102.0 4.02	108.0 4.25	3.0 0.12	140.0 5.51	134.0 5.28	1.9 0.07	3.3 0.13	104.0	40.9	0.1264	1.26 2.79
34.000 1.3386	27.000 1.0630	-1.6 -0.06	3.0 0.12	104.0 4.09	109.0 4.29	2.5 0.10	143.0 5.63	135.0 5.31	3.1 0.12	3.1 0.12	150.5	36.1	0.1413	2.15 4.75
36.322 1.4300	30.162 1.1875	2.5 0.10	8.0 0.31	103.0 4.06	119.0 4.69	3.3 0.13	144.0 5.67	135.0 5.31	4.1 0.16	1.7 0.07	151.4	38.3	0.1416	2.43 5.35
46.000 1.8110	38.000 1.4961	-10.7 -0.42	3.0 0.12	105.4 4.15	111.0 4.37	3.0 0.12	154.0 6.06	145.0 5.71	1.4 0.05	3.1 0.12	209.8	39.7	0.0998	3.74 8.22
57.531 2.2650	48.000 1.8898	-15.2 -0.60	6.4 0.25	108.0 4.25	120.0 4.72	3.0 0.12	174.3 6.86	170.0 6.69	5.5 0.22	0.7 0.03	264.1	44.9	0.1072	7.35 16.22
21.433 0.8438	16.670 0.6563	1.3 0.05	1.5 0.06	101.0 3.98	103.0 4.06	1.5 0.06	125.0 4.92	122.0 4.80	0.6 0.02	1.4 0.06	125.3	90.8	0.1220	0.79 1.74
30.162 1.1875	24.608 0.9688	-4.6 -0.18	2.3 0.09	102.0 4.02	105.0 4.13	2.3 0.09	131.0 5.16	126.0 4.96	1.3 0.05	-0.2 0.00	149.4	84.1	0.1213	1.33 2.94
34.925 1.3750	26.195 1.0313	-1.0 -0.04	3.5 0.14	103.0 4.06	110.0 4.33	3.3 0.13	140.0 5.51	131.0 5.16	2.5 0.10	0.3 0.02	153.2	38.1	0.1428	1.94 4.26

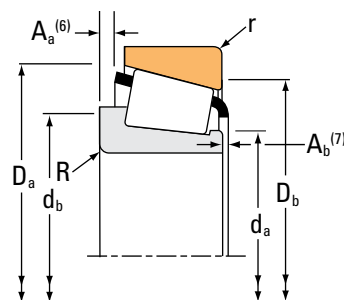
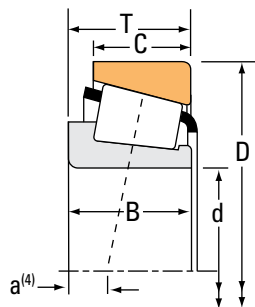
⁽⁴⁾Negative value indicates effective center inside cone (inner-ring) backface.
⁽⁵⁾These maximum fillet radii will be cleared by the bearing corners.
⁽⁶⁾Negative value indicates cage extends beyond cone (inner-ring) backface.
⁽⁷⁾Negative value indicates cage that does not extend beyond cone (inner-ring) front face.

Continued on next page.

TAPERED ROLLER BEARINGS

SINGLE-ROW • TYPE TS

TYPE TS



Bearing Dimensions			Load Ratings							Part Number		
Bore d	O.D. D	Width T	Dynamic ⁽¹⁾		Factors ⁽²⁾		Dynamic ⁽³⁾		Factors ⁽²⁾	Static	Inner	Outer
			C ₁	e	Y	C ₉₀	C _{a90}	K	C ₀			
mm in.	mm in.	mm in.	N lbf			N lbf	N lbf			N lbf		
95.250 3.7500	146.050 5.7500	33.338 1.3125	197000 44300	0.45	1.34	51100 11500	39200 8810	1.30		307000 69000	47898	47820
95.250 3.7500	147.638 5.8125	35.717 1.4062	216000 48600	0.44	1.36	56000 12600	42400 9530	1.32		319000 71600	594	592XS
95.250 3.7500	147.828 5.8200	35.717 1.4062	216000 48600	0.44	1.36	56000 12600	42400 9530	1.32		319000 71600	594	592AX
95.250 3.7500	148.430 5.8437	28.575 1.1250	193000 43400	0.49	1.22	50100 11300	42200 9480	1.19		241000 54300	42375	42584
95.250 3.7500	148.430 5.8437	28.575 1.1250	193000 43400	0.49	1.22	50100 11300	42200 9480	1.19		241000 54300	42376	42584
95.250 3.7500	148.430 5.8437	28.575 1.1250	163000 36600	0.49	1.22	42200 9490	35600 8000	1.19		241000 54300	42375A	42584
95.250 3.7500	149.225 5.8750	31.750 1.2500	193000 43400	0.49	1.22	50100 11300	42200 9480	1.19		241000 54300	42376	42587
95.250 3.7500	149.225 5.8750	31.750 1.2500	193000 43400	0.49	1.22	50100 11300	42200 9480	1.19		241000 54300	42375	42587
95.250 3.7500	150.000 5.9055	35.966 1.4160	216000 48600	0.44	1.36	56000 12600	42400 9530	1.32		319000 71600	594	JM719113
95.250 3.7500	150.000 5.9055	35.966 1.4160	216000 48600	0.44	1.36	56000 12600	42400 9530	1.32		319000 71600	594AA	JM719113
95.250 3.7500	150.000 5.9055	35.992 1.4170	216000 48600	0.44	1.36	56000 12600	42400 9530	1.32		319000 71600	594	593X
95.250 3.7500	152.400 6.0000	39.688 1.5625	216000 48600	0.44	1.36	56000 12600	42400 9530	1.32		319000 71600	594	592A
95.250 3.7500	152.400 6.0000	39.688 1.5625	216000 48600	0.44	1.36	56000 12600	42400 9530	1.32		319000 71600	594A	592A
95.250 3.7500	157.162 6.1875	36.512 1.4375	223000 50200	0.47	1.26	57900 13000	47100 10600	1.23		343000 77000	52375	52618
95.250 3.7500	161.925 6.3750	36.512 1.4375	223000 50200	0.47	1.26	57900 13000	47100 10600	1.23		343000 77000	52375	52637
95.250 3.7500	161.925 6.3750	39.687 1.5626	223000 50200	0.47	1.26	57900 13000	47100 10600	1.23		343000 77000	52375	52638
95.250 3.7500	168.275 6.6250	41.275 1.6250	265000 59500	0.47	1.28	68600 15400	55300 12400	1.24		386000 86700	683	672

⁽¹⁾Based on 1×10^6 revolutions L_{10} life, for the ISO life-calculation method.

⁽²⁾Consult your Timken engineer for instructions on use or review the Timken Engineering Manual on timken.com/catalogs.

⁽³⁾Based on 90×10^6 revolutions L_{10} life, for The Timken Company life-calculation method. C_{90} and C_{a90} are radial and thrust values.

Bearing Dimensions											Geometry Factors			Bearing Weight
Width B	Width C	Eff. Ctr. a ⁽⁴⁾	Shaft			Housing			Cage		G ₁	G ₂	C _g	
			Max Shaft Fillet Radius R ⁽⁵⁾	Backing Shoulder Dia. d _a	Backing Shoulder Dia. d _b	Max Housing Fillet Radius r ⁽⁵⁾	Backing Shoulder Dia. D _a	Backing Shoulder Dia. D _b	A _a ⁽⁶⁾	A _b ⁽⁷⁾				
mm in.	mm in.	mm in.	mm in.	mm in.	mm in.	mm in.	mm in.	mm in.	mm in.	mm in.				kg lbs.
34.925 1.3750	26.195 1.0313	-1.0 -0.04	7.0 0.28	103.0 4.06	117.0 4.61	3.3 0.13	140.0 5.51	131.0 5.16	2.5 0.10	0.3 0.02	153.2	38.1	0.1428	1.88 4.13
36.322 1.4300	26.192 1.0312	-2.5 -0.10	3.5 0.14	104.0 4.09	110.0 4.33	3.3 0.13	142.0 5.59	133.0 5.24	4.1 0.16	1.7 0.07	151.4	38.3	0.1416	2.05 4.52
36.322 1.4300	26.192 1.0312	-2.5 -0.10	3.5 0.14	104.0 4.09	110.0 4.33	3.3 0.13	142.0 5.59	133.0 5.24	4.1 0.16	1.7 0.07	151.4	38.3	0.1416	2.09 4.60
28.971 1.1406	21.433 0.8438	3.0 0.12	3.0 0.12	103.0 4.06	108.0 4.25	3.0 0.12	142.0 5.59	134.0 5.28	2.8 0.11	3.0 0.12	129.7	37.2	0.1386	1.73 3.81
28.971 1.1406	21.433 0.8438	3.0 0.12	3.5 0.14	103.0 4.06	109.0 4.29	3.0 0.12	142.0 5.59	134.0 5.28	2.8 0.11	3.0 0.12	129.7	37.2	0.1386	1.73 3.80
28.971 1.1406	21.433 0.8438	3.0 0.12	0.8 0.03	103.0 4.06	109.0 4.09	3.0 0.12	142.0 5.59	134.0 5.28	2.8 0.11	3.0 0.12	129.7	37.2	0.1386	1.73 3.82
28.971 1.1406	24.608 0.9688	3.0 0.12	3.5 0.14	103.0 4.06	109.0 4.29	3.3 0.13	142.0 5.59	134.0 5.28	2.8 0.11	3.0 0.12	129.7	37.2	0.1386	1.88 4.14
28.971 1.1406	24.608 0.9688	3.0 0.12	3.0 0.12	103.0 4.06	108.0 4.25	3.3 0.13	142.0 5.59	134.0 5.28	2.8 0.11	3.0 0.12	129.7	37.2	0.1386	1.88 4.15
36.322 1.4300	27.000 1.0630	-2.5 -0.10	3.5 0.14	104.0 4.09	110.0 4.33	2.5 0.10	143.0 5.63	135.0 5.31	4.1 0.16	1.7 0.07	151.4	38.3	0.1416	2.19 4.83
36.322 1.4300	27.000 1.0630	-2.5 -0.10	0.8 0.03	104.0 4.09	107.0 4.21	2.5 0.10	143.0 5.63	135.0 5.31	4.1 0.16	1.7 0.07	151.4	38.3	0.1416	2.20 4.87
36.322 1.4300	27.000 1.0630	-2.5 -0.10	3.5 0.14	104.0 4.09	110.0 4.33	3.0 0.12	142.0 5.59	134.0 5.28	4.1 0.16	1.7 0.07	151.4	38.3	0.1416	2.19 4.82
36.322 1.4300	30.162 1.1875	-2.5 -0.10	3.5 0.14	104.0 4.09	110.0 4.33	3.3 0.13	144.0 5.67	135.0 5.31	4.1 0.16	1.7 0.07	151.4	38.3	0.1416	2.48 5.47
36.322 1.4300	30.162 1.1875	-2.5 -0.10	5.0 0.20	104.0 4.09	113.0 4.45	3.3 0.13	144.0 5.67	135.0 5.31	4.1 0.16	1.7 0.07	151.4	38.3	0.1416	2.46 5.43
36.116 1.4219	26.195 1.0313	-0.5 -0.02	3.5 0.14	105.0 4.13	112.0 4.41	3.3 0.13	152.0 5.98	142.0 5.59	4.4 0.17	2.5 0.10	175.4	41.7	0.1519	2.67 5.88
36.116 1.4219	26.195 1.0313	-0.5 -0.02	3.5 0.14	105.0 4.13	112.0 4.41	3.3 0.13	154.0 6.06	144.0 5.67	4.4 0.17	2.5 0.10	175.4	41.7	0.1519	2.90 6.39
36.116 1.4219	29.370 1.1563	-0.5 -0.02	3.5 0.14	105.0 4.13	112.0 4.41	3.3 0.13	154.0 6.06	143.0 5.63	4.4 0.17	2.5 0.10	175.4	41.7	0.1519	3.07 6.76
41.275 1.6250	30.162 1.1875	-2.8 -0.11	3.5 0.14	106.0 4.17	113.0 4.45	3.3 0.13	160.0 6.30	149.0 5.87	4.9 0.19	2.1 0.08	182.5	37.3	0.1056	3.70 8.15

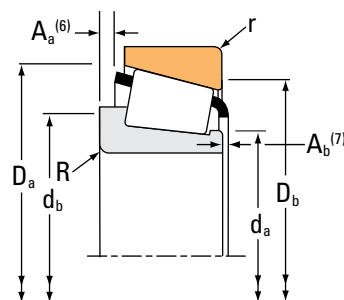
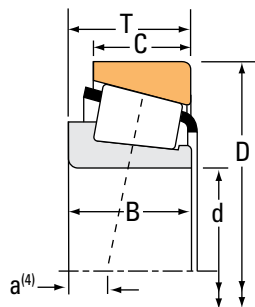
⁽⁴⁾Negative value indicates effective center inside cone (inner-ring) backface.
⁽⁵⁾These maximum fillet radii will be cleared by the bearing corners.
⁽⁶⁾Negative value indicates cage extends beyond cone (inner-ring) backface.
⁽⁷⁾Negative value indicates cage that does not extend beyond cone (inner-ring) front face.

Continued on next page.

TAPERED ROLLER BEARINGS

SINGLE-ROW • TYPE TS

TYPE TS



Bearing Dimensions			Load Ratings							Part Number			
Bore d	O.D. D	Width T	Dynamic ⁽¹⁾		Factors ⁽²⁾		Dynamic ⁽³⁾		Factors ⁽²⁾		Static C ₀	Inner	Outer
			C ₁	e	Y	C ₉₀	C _{a90}	K	N	N			
mm in.	mm in.	mm in.	N lbf			N lbf	N lbf		N lbf				
95.250 3.7500	168.275 6.6250	41.275 1.6250	265000 59500	0.47	1.28	68600 15400	55300 12400	1.24	386000 86700		683XA	672	
95.250 3.7500	171.450 6.7500	47.625 1.8750	403000 90500	0.37	1.63	104000 23500	65600 14700	1.59	474000 107000		77375	77675	
95.250 3.7500	171.450 6.7500	47.625 1.8750	340000 76400	0.37	1.63	88100 19800	55300 12400	1.59	474000 107000		77376	77675	
95.250 3.7500	171.450 6.7500	50.800 2.0000	403000 90500	0.37	1.63	104000 23500	65600 14700	1.59	474000 107000		77375	77676X	
95.250 3.7500	180.975 7.1250	47.625 1.8750	346000 77800	0.39	1.56	89700 20200	59200 13300	1.51	495000 111000		776	772	
95.250 3.7500	190.500 7.5000	57.150 2.2500	458000 103000	0.33	1.79	119000 26700	68000 15300	1.74	630000 142000		864	854	
95.250 3.7500	190.500 7.5000	57.150 2.2500	534000 120000	0.33	1.79	138000 31100	79300 17800	1.74	692000 156000		HH221440	HH221410	
95.250 3.7500	200.025 7.8750	61.912 2.4375	534000 120000	0.33	1.79	138000 31100	79300 17800	1.74	692000 156000		HH221440	HH221416	
95.250 3.7500	200.025 7.8750	73.025 2.8750	715000 161000	0.32	1.88	185000 41700	101000 22800	1.83	906000 204000		EH220749	EH220710	
96.838 3.8125	148.430 5.8437	28.575 1.1250	193000 43400	0.49	1.22	50100 11300	42200 9480	1.19	241000 54300		42381	42584	
96.838 3.8125	149.225 5.8750	31.750 1.2500	193000 43400	0.49	1.22	50100 11300	42200 9480	1.19	241000 54300		42381	42587	
96.838 3.8125	188.912 7.4375	50.800 2.0000	383000 86100	0.87	0.69	99300 22300	147000 33100	0.67	392000 88100		90381	90744	
98.425 3.8750	157.162 6.1875	36.512 1.4375	223000 50200	0.47	1.26	57900 13000	47100 10600	1.23	343000 77000		52387	52618	
98.425 3.8750	161.925 6.3750	36.512 1.4375	223000 50200	0.47	1.26	57900 13000	47100 10600	1.23	343000 77000		52387	52637	
98.425 3.8750	168.275 6.6250	41.275 1.6250	265000 59500	0.47	1.28	68600 15400	55300 12400	1.24	386000 86700		685	672	
98.425 3.8750	180.975 7.1250	47.625 1.8750	346000 77800	0.39	1.56	89700 20200	59200 13300	1.51	495000 111000		779	772	
98.425 3.8750	184.150 7.2500	63.500 2.5000	628000 141000	0.37	1.60	163000 36600	104000 23500	1.56	772000 174000		HH421246C	HH421210	

⁽¹⁾Based on 1 x 10⁶ revolutions L₁₀ life, for the ISO life-calculation method.

⁽²⁾Consult your Timken engineer for instructions on use or review the Timken Engineering Manual on timken.com/catalogs.

⁽³⁾Based on 90 x 10⁶ revolutions L₁₀ life, for The Timken Company life-calculation method. C₉₀ and C_{a90} are radial and thrust values.

Bearing Dimensions											Geometry Factors			Bearing Weight
Width B	Width C	Eff. Ctr. a ⁽⁴⁾	Shaft			Housing			Cage		G ₁	G ₂	C _g	
			Max Shaft Fillet Radius R ⁽⁵⁾	Backing Shoulder Dia. d _a d _b		Max Housing Fillet Radius r ⁽⁵⁾	Backing Shoulder Dia. D _a D _b		A _a ⁽⁶⁾	A _b ⁽⁷⁾				
mm in.	mm in.	mm in.	mm in.	mm in.	mm in.	mm in.	mm in.	mm in.	mm in.	mm in.				kg lbs.
41.275 1.6250	30.162 1.1875	-2.8 -0.11	5.0 0.20	106.0 4.17	116.0 4.57	3.3 0.13	160.0 6.30	149.0 5.87	4.9 0.19	2.1 0.08	182.5	37.3	0.1056	3.69 8.11
48.260 1.9000	38.100 1.5000	-9.7 -0.38	3.5 0.14	106.0 4.17	113.0 4.45	3.3 0.13	161.0 6.34	153.0 6.02	3.4 0.13	1.0 0.04	206.2	37.7	0.1017	4.54 10.02
48.260 1.9000	38.100 1.5000	-9.7 -0.38	6.4 0.25	106.0 4.17	118.0 4.65	3.3 0.13	161.0 6.34	153.0 6.02	3.4 0.13	1.0 0.04	206.2	37.7	0.1017	4.51 9.94
48.260 1.9000	41.275 1.6250	-9.7 -0.38	3.5 0.14	106.0 4.17	113.0 4.45	3.3 0.13	161.0 6.34	152.0 5.98	3.4 0.13	1.0 0.04	206.2	37.7	0.1017	4.74 10.45
48.006 1.8900	38.100 1.5000	-8.1 -0.32	3.5 0.14	107.0 4.21	114.0 4.49	3.3 0.13	168.0 6.61	161.0 6.34	3.6 0.14	1.3 0.05	227.3	41.3	0.1067	5.39 11.89
57.531 2.2650	44.450 1.7500	-15.2 -0.60	8.0 0.31	108.0 4.25	123.0 4.84	3.3 0.13	174.0 6.85	170.0 6.69	5.5 0.22	0.7 0.03	264.1	44.9	0.1072	7.23 15.95
57.531 2.2650	46.038 1.8125	-15.0 -0.59	8.0 0.31	110.0 4.33	125.0 4.92	3.3 0.13	179.0 7.05	171.0 6.73	2.5 0.10	3.2 0.13	265.6	28.4	0.1072	7.38 16.26
57.531 2.2650	50.800 2.0000	-15.0 -0.59	8.0 0.31	110.0 4.33	125.0 4.92	3.3 0.13	179.0 7.05	174.0 6.85	2.5 0.10	3.2 0.13	265.6	28.4	0.1072	8.87 19.53
73.025 2.8750	58.738 2.3125	-24.6 -0.97	3.3 0.13	115.7 4.55	120.0 4.72	3.3 0.13	186.9 7.36	177.0 6.97	5.7 0.22	2.4 0.10	306.3	26.2	0.1106	10.65 23.48
28.971 1.1406	21.433 0.8438	3.0 0.12	3.5 0.14	105.0 4.13	112.0 4.41	3.0 0.12	142.0 5.59	134.0 5.28	2.8 0.11	3.0 0.12	129.7	37.2	0.1386	1.67 3.68
28.971 1.1406	24.608 0.9688	3.0 0.12	3.5 0.14	105.0 4.13	112.0 4.41	3.3 0.13	142.0 5.59	134.0 5.28	2.8 0.11	3.0 0.12	129.7	37.2	0.1386	1.82 4.02
46.038 1.8125	31.750 1.2500	12.7 0.50	3.5 0.14	113.0 4.44	125.0 4.92	3.3 0.13	179.0 7.06	161.0 6.34	11.0 0.43	3.7 0.15	149.6	23.8	0.1180	5.59 12.33
36.116 1.4219	26.195 1.0313	-0.5 -0.02	3.5 0.14	108.0 4.25	114.0 4.49	3.3 0.13	152.0 5.98	142.0 5.59	4.4 0.17	2.5 0.10	175.4	41.7	0.1519	2.53 5.57
36.116 1.4219	26.195 1.0313	-0.5 -0.02	3.5 0.14	108.0 4.25	114.0 4.49	3.3 0.13	154.0 6.06	144.0 5.67	4.4 0.17	2.5 0.10	175.4	41.7	0.1519	2.76 6.08
41.275 1.6250	30.162 1.1875	-2.8 -0.11	3.5 0.14	109.0 4.29	116.0 4.57	3.3 0.13	160.0 6.30	149.0 5.87	4.9 0.19	2.1 0.08	182.5	37.3	0.1056	3.55 7.80
48.006 1.8900	38.100 1.5000	-8.1 -0.32	3.5 0.14	110.0 4.33	116.0 4.57	3.3 0.13	168.0 6.61	161.0 6.34	3.6 0.14	1.3 0.05	227.3	41.3	0.1067	5.21 11.49
63.500 2.5000	52.388 2.0625	-16.8 -0.66	6.4 0.25	115.1 4.53	127.0 5.00	3.3 0.13	176.0 6.93	163.0 6.42	3.1 0.12	3.1 0.13	298.2	40.9	0.1162	7.43 16.38

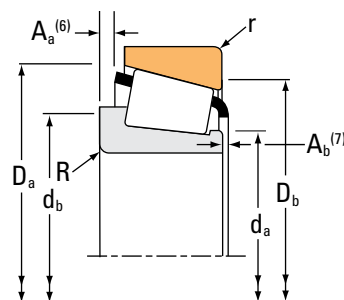
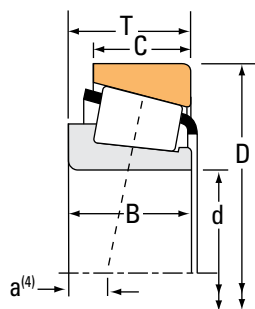
⁽⁴⁾Negative value indicates effective center inside cone (inner-ring) backface.
⁽⁵⁾These maximum fillet radii will be cleared by the bearing corners.
⁽⁶⁾Negative value indicates cage extends beyond cone (inner-ring) backface.
⁽⁷⁾Negative value indicates cage that does not extend beyond cone (inner-ring) front face.

Continued on next page.

TAPERED ROLLER BEARINGS

SINGLE-ROW • TYPE TS

TYPE TS



Bearing Dimensions			Load Ratings							Part Number		
Bore d	O.D. D	Width T	Dynamic ⁽¹⁾		Factors ⁽²⁾		Dynamic ⁽³⁾		Factors ⁽²⁾	Static	Inner	Outer
			C ₁	e	Y	C ₉₀	C _{a90}	K	C ₀			
mm in.	mm in.	mm in.	N lbf			N lbf	N lbf			N lbf		
98.425 3.8750	190.500 7.5000	57.150 2.2500	534000 120000	0.33	1.79	138000 31100	79300 17800	1.74		692000 156000	HH221442	HH221410
98.425 3.8750	212.725 8.3750	66.675 2.6250	680000 153000	0.33	1.84	176000 39600	98300 22100	1.79		906000 204000	HH224332	HH224310
99.975 3.9360	156.975 6.1801	42.000 1.6535	300000 67500	0.33	1.80	77800 17500	44300 9960	1.76		438000 98500	HM220149	HM220110
99.975 3.9360	214.975 8.4636	64.798 2.5511	680000 153000	0.33	1.84	176000 39600	98300 22100	1.79		906000 204000	HH224334	HH224314
100.000 3.9370	145.000 5.7087	24.000 0.9449	149000 33400	0.47	1.27	38600 8670	31200 7020	1.24		172000 38700	JP10049A	JP10010
100.000 3.9370	145.000 5.7087	24.000 0.9449	125000 28200	0.47	1.27	32500 7310	26300 5920	1.24		172000 38700	JP10049	JP10010A
100.000 3.9370	145.000 5.7087	24.000 0.9449	125000 28200	0.47	1.27	32500 7310	26300 5920	1.24		172000 38700	JP10049	JP10010
100.000 3.9370	150.000 5.9055	32.000 1.2598	162000 36500	0.50	1.20	42100 9470	36200 8130	1.16		242000 54400	JLM820048	JLM820012
100.000 3.9370	155.000 6.1024	36.000 1.4173	231000 52000	0.47	1.27	60000 13500	48600 10900	1.24		355000 79900	JM720249	JM720210
100.000 3.9370	160.000 6.2992	36.512 1.4375	211000 47400	0.47	1.26	54700 12300	44500 10000	1.23		343000 77000	52394X	52630X
100.000 3.9370	160.000 6.2992	41.000 1.6142	331000 74400	0.47	1.28	85800 19300	69100 15500	1.24		416000 93500	JHM720249	JHM720210
100.000 3.9370	180.000 7.0866	48.000 1.8898	346000 77800	0.39	1.56	89700 20200	59200 13300	1.51		495000 111000	783	773
100.000 3.9370	180.975 7.1250	47.625 1.8750	346000 77800	0.39	1.56	89700 20200	59200 13300	1.51		495000 111000	783	772
100.000 3.9370	200.000 7.8740	52.761 2.0772	482000 108000	0.63	0.95	125000 28100	135000 30400	0.92		519000 117000	98394X	98788
100.000 3.9370	215.000 8.4646	66.675 2.6250	680000 153000	0.33	1.84	176000 39600	98300 22100	1.79		906000 204000	JHH224333	JHH224315
100.012 3.9375	157.162 6.1875	36.512 1.4375	223000 50200	0.47	1.26	57900 13000	47100 10600	1.23		343000 77000	52393	52618
100.012 3.9375	161.925 6.3750	36.512 1.4375	223000 50200	0.47	1.26	57900 13000	47100 10600	1.23		343000 77000	52393	52637

⁽¹⁾Based on 1×10^6 revolutions L_{10} life, for the ISO life-calculation method.

⁽²⁾Consult your Timken engineer for instructions on use or review the Timken Engineering Manual on timken.com/catalogs.

⁽³⁾Based on 90×10^6 revolutions L_{10} life, for The Timken Company life-calculation method. C_{90} and C_{a90} are radial and thrust values.

Bearing Dimensions											Geometry Factors			Bearing Weight
Width B	Width C	Eff. Ctr. a ⁽⁴⁾	Shaft			Housing			Cage		G ₁	G ₂	C _g	
			Max Shaft Fillet Radius R ⁽⁵⁾	Backing Shoulder Dia. d _a	Backing Shoulder Dia. d _b	Max Housing Fillet Radius r ⁽⁵⁾	Backing Shoulder Dia. D _a	Backing Shoulder Dia. D _b	A _a ⁽⁶⁾	A _b ⁽⁷⁾				
mm in.	mm in.	mm in.	mm in.	mm in.	mm in.	mm in.	mm in.	mm in.	mm in.	mm in.				kg lbs.
57.531 2.2650	46.038 1.8125	-15.0 -0.59	3.5 0.14	113.0 4.45	119.0 4.69	3.3 0.13	179.0 7.05	171.0 6.73	2.5 0.10	3.2 0.13	265.6	28.4	0.1072	7.22 15.92
66.675 2.6250	53.975 2.1250	-18.8 -0.74	3.5 0.14	119.0 4.69	123.0 4.84	3.3 0.13	201.7 7.94	192.0 7.56	4.8 0.19	2.9 0.12	366.6	47.9	0.1182	11.36 25.03
42.000 1.6535	34.000 1.3386	-8.6 -0.34	8.0 0.31	108.0 4.25	122.9 4.84	3.5 0.14	151.0 5.94	142.0 5.59	2.1 0.08	2.4 0.10	203.6	45.9	0.0981	2.79 6.15
66.675 2.6250	50.800 2.0000	-18.8 -0.74	3.5 0.14	120.0 4.72	124.0 4.88	3.3 0.13	201.2 7.92	192.0 7.56	4.8 0.19	2.9 0.12	366.6	47.9	0.1182	11.34 25.00
22.500 0.8858	17.500 0.6890	6.1 0.24	5.0 0.20	106.0 4.17	116.0 4.57	3.0 0.12	140.0 5.51	134.0 5.28	1.9 0.07	3.3 0.13	104.0	40.9	0.1264	1.13 2.49
22.500 0.8858	17.500 0.6890	6.1 0.24	3.0 0.12	106.0 4.17	112.0 4.41	0.8 0.03	140.0 5.51	136.0 5.35	1.9 0.07	3.3 0.13	104.0	40.9	0.1264	1.15 2.54
22.500 0.8858	17.500 0.6890	6.1 0.24	3.0 0.12	106.0 4.17	112.0 4.41	3.0 0.12	140.0 5.51	134.0 5.28	1.9 0.07	3.3 0.13	104.0	40.9	0.1264	1.13 2.49
30.000 1.1811	26.000 1.0236	4.6 0.18	2.3 0.09	107.0 4.21	111.0 4.37	2.3 0.09	144.0 5.67	135.0 5.31	2.3 0.09	1.0 0.04	133.1	38.3	0.1405	1.81 3.99
35.000 1.3780	28.000 1.1024	0.3 0.01	3.0 0.12	109.0 4.29	115.0 4.53	2.5 0.10	149.0 5.87	140.0 5.51	3.0 0.12	3.1 0.12	174.8	48.5	0.1043	2.36 5.20
36.116 1.4219	26.195 1.0313	-0.5 -0.02	3.5 0.14	109.0 4.29	116.0 4.57	3.0 0.12	153.0 6.02	144.0 5.67	4.4 0.17	2.5 0.10	175.4	41.7	0.1519	2.59 5.72
40.000 1.5748	32.000 1.2598	-2.5 -0.10	3.0 0.12	109.4 4.30	117.0 4.61	2.5 0.10	153.9 6.06	143.0 5.63	3.3 0.13	3.7 0.15	187.7	45.3	0.1068	3.00 6.60
48.006 1.8900	40.000 1.5748	-8.1 -0.32	3.5 0.14	111.0 4.37	118.0 4.65	3.0 0.12	168.0 6.61	160.0 6.30	3.6 0.14	1.3 0.05	227.3	41.3	0.1067	5.09 11.22
48.006 1.8900	38.100 1.5000	-8.1 -0.32	3.5 0.14	111.0 4.37	118.0 4.65	3.3 0.13	168.0 6.61	161.0 6.34	3.6 0.14	1.3 0.05	227.3	41.3	0.1067	5.12 11.29
49.212 1.9375	34.925 1.3750	1.3 0.05	3.5 0.14	120.6 4.75	126.0 4.96	3.3 0.13	188.0 7.40	174.0 6.85	8.6 0.34	5.4 0.22	203.4	37.5	0.1197	6.85 15.11
66.675 2.6250	53.975 2.1250	-18.9 -0.74	7.0 0.28	120.0 4.72	131.0 5.16	3.3 0.13	201.7 7.94	193.0 7.60	4.8 0.19	2.9 0.12	366.6	47.9	0.1182	11.52 25.40
36.116 1.4219	26.195 1.0313	-0.5 -0.02	3.5 0.14	109.0 4.29	116.0 4.57	3.3 0.13	152.0 5.98	142.0 5.59	4.4 0.17	2.5 0.10	175.4	41.7	0.1519	2.46 5.42
36.116 1.4219	26.195 1.0313	-0.5 -0.02	3.5 0.14	109.0 4.29	116.0 4.57	3.3 0.13	154.0 6.06	144.0 5.67	4.4 0.17	2.5 0.10	175.4	41.7	0.1519	2.69 5.93

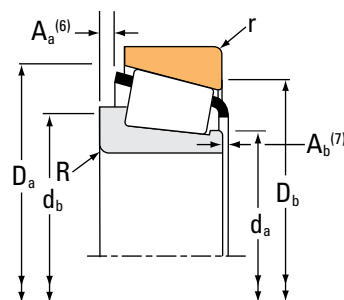
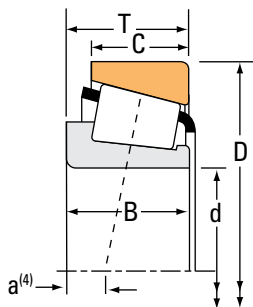
(4) Negative value indicates effective center inside cone (inner-ring) backface.
 (5) These maximum fillet radii will be cleared by the bearing corners.
 (6) Negative value indicates cage extends beyond cone (inner-ring) backface.
 (7) Negative value indicates cage that does not extend beyond cone (inner-ring) front face.

Continued on next page.

TAPERED ROLLER BEARINGS

SINGLE-ROW • TYPE TS

TYPE TS



Bearing Dimensions			Load Ratings							Part Number			
Bore d	O.D. D	Width T	Dynamic ⁽¹⁾		Factors ⁽²⁾		Dynamic ⁽³⁾		Factors ⁽²⁾		Static C ₀	Inner	Outer
			C ₁	e	Y	C ₉₀	C _{a90}	K	N	N			
mm in.	mm in.	mm in.	N lbf			N lbf	N lbf		N lbf				
100.012 3.9375	161.925 6.3750	39.687 1.5625	223000 50200	0.47	1.26	57900 13000	47100 10600	1.23	343000 77000			52393	52638
101.600 4.0000	134.938 5.3125	15.875 0.6250	64900 14600	0.37	1.62	16800 3780	10700 2400	1.58	104000 23400			LL420549	LL420510
101.600 4.0000	136.525 5.3750	21.433 0.8438	97800 22000	0.37	1.63	25400 5700	16000 3600	1.59	175000 39400			L420449	L420410
101.600 4.0000	146.050 5.7500	21.433 0.8438	96000 21600	0.39	1.53	24900 5600	16700 3760	1.49	175000 39400			L521945	L521910
101.600 4.0000	146.050 5.7500	25.400 1.0000	132000 29600	0.46	1.31	34100 7670	26800 6020	1.27	202000 45400			LM720648	LM720610
101.600 4.0000	152.400 6.0000	21.433 0.8438	96000 21600	0.39	1.53	24900 5600	16700 3760	1.49	175000 39400			L521945	L521914
101.600 4.0000	157.162 6.1875	36.512 1.4375	223000 50200	0.47	1.26	57900 13000	47100 10600	1.23	343000 77000			52400	52618
101.600 4.0000	157.162 6.1875	36.512 1.4375	223000 50200	0.47	1.26	57900 13000	47100 10600	1.23	343000 77000			52401	52618
101.600 4.0000	160.000 6.2992	36.512 1.4375	223000 50200	0.47	1.26	57900 13000	47100 10600	1.23	343000 77000			52400	52630X
101.600 4.0000	161.925 6.3750	36.512 1.4375	223000 50200	0.47	1.26	57900 13000	47100 10600	1.23	343000 77000			52400	52637
101.600 4.0000	161.925 6.3750	39.687 1.5625	223000 50200	0.47	1.26	57900 13000	47100 10600	1.23	343000 77000			52400	52638
101.600 4.0000	168.275 6.6250	41.275 1.6250	265000 59500	0.47	1.28	68600 15400	55300 12400	1.24	386000 86700			687	672
101.600 4.0000	168.275 6.6250	41.275 1.6250	265000 59500	0.47	1.28	68600 15400	55300 12400	1.24	386000 86700			687	672A
101.600 4.0000	171.450 6.7500	41.275 1.6250	265000 59500	0.47	1.28	68600 15400	55300 12400	1.24	386000 86700			687	674
101.600 4.0000	177.800 7.0000	34.925 1.3750	170000 38300	1.17	0.51	44200 9930	88600 19900	0.50	219000 49200			LM921845	LM921810
101.600 4.0000	180.000 7.0866	48.000 1.8898	346000 77800	0.39	1.56	89700 20200	59200 13300	1.51	495000 111000			780	773
101.600 4.0000	180.975 7.1250	47.625 1.8750	346000 77800	0.39	1.56	89700 20200	59200 13300	1.51	495000 111000			780	772

⁽¹⁾Based on 1×10^6 revolutions L_{10} life, for the ISO life-calculation method.

⁽²⁾Consult your Timken engineer for instructions on use or review the Timken Engineering Manual on timken.com/catalogs.

⁽³⁾Based on 90×10^6 revolutions L_{10} life, for The Timken Company life-calculation method. C_{90} and C_{a90} are radial and thrust values.

Bearing Dimensions											Geometry Factors			Bearing Weight
Width B	Width C	Eff. Ctr. a ⁽⁴⁾	Shaft			Housing			Cage		G ₁	G ₂	C _g	
			Max Shaft Fillet Radius R ⁽⁵⁾	Backing Shoulder Dia. d _a	Backing Shoulder Dia. d _b	Max Housing Fillet Radius r ⁽⁵⁾	Backing Shoulder Dia. D _a	Backing Shoulder Dia. D _b	A _a ⁽⁶⁾	A _b ⁽⁷⁾				
mm in.	mm in.	mm in.	mm in.	mm in.	mm in.	mm in.	mm in.	mm in.	mm in.	mm in.				kg lbs.
36.116 1.4219	29.370 1.1563	-0.5 -0.02	3.5 0.14	109.0 4.29	116.0 4.57	3.3 0.13	154.0 6.06	143.0 5.63	4.4 0.17	2.5 0.10	175.4	41.7	0.1519	2.86 6.29
15.083 0.5938	11.908 0.4688	5.6 0.22	1.5 0.06	107.0 4.21	109.0 4.29	1.5 0.06	130.0 5.12	128.0 5.04	1.0 0.04	2.1 0.09	95.5	89.8	0.1126	0.56 1.25
21.433 0.8438	16.670 0.6563	2.8 0.11	1.5 0.06	107.0 4.21	109.0 4.29	1.5 0.06	132.0 5.20	128.0 5.04	0.7 0.02	1.6 0.07	139.9	102.5	0.1286	0.84 1.86
21.433 0.8438	16.670 0.6563	4.8 0.19	1.5 0.06	109.0 4.29	112.0 4.41	1.5 0.06	141.0 5.55	136.0 5.35	0.7 0.03	1.6 0.07	152.1	107.9	0.1346	1.15 2.56
25.400 1.0000	19.050 0.7500	4.8 0.19	1.5 0.06	109.0 4.29	110.0 4.33	1.5 0.06	141.0 5.55	136.0 5.35	2.4 0.09	1.1 0.05	127.6	62.7	0.1342	1.29 2.84
21.433 0.8438	16.670 0.6563	4.8 0.19	1.5 0.06	109.0 4.29	112.0 4.41	1.5 0.06	144.0 5.67	139.0 5.47	0.7 0.03	1.6 0.07	152.1	107.9	0.1346	1.35 2.99
36.116 1.4219	26.195 1.0313	-0.5 -0.02	3.5 0.14	111.0 4.37	117.0 4.61	3.3 0.13	152.0 5.98	142.0 5.59	4.4 0.17	2.5 0.10	175.4	41.7	0.1519	2.40 5.28
36.116 1.4219	26.195 1.0313	-0.5 -0.02	8.0 0.31	112.0 4.41	128.0 5.04	3.3 0.13	152.0 5.98	142.0 5.59	4.4 0.17	2.5 0.10	175.4	41.7	0.1519	2.37 5.22
36.116 1.4219	26.195 1.0313	-0.5 -0.02	3.5 0.14	111.0 4.37	117.0 4.61	3.0 0.12	153.0 6.02	144.0 5.67	4.4 0.17	2.5 0.10	175.4	41.7	0.1519	2.53 5.58
36.116 1.4219	26.195 1.0313	-0.5 -0.02	3.5 0.14	111.0 4.37	117.0 4.61	3.3 0.13	154.0 6.06	144.0 5.67	4.4 0.17	2.5 0.10	175.4	41.7	0.1519	2.63 5.79
36.116 1.4219	29.370 1.1563	-0.5 -0.02	3.5 0.14	111.0 4.37	117.0 4.61	3.3 0.13	154.0 6.06	143.0 5.63	4.4 0.17	2.5 0.10	175.4	41.7	0.1519	2.80 6.16
41.275 1.6250	30.162 1.1875	-2.8 -0.11	3.5 0.14	112.0 4.41	118.0 4.65	3.3 0.13	160.0 6.30	149.0 5.87	4.9 0.19	2.1 0.08	182.5	37.3	0.1056	3.38 7.45
41.275 1.6250	34.925 1.3750	-2.8 -0.11	3.5 0.14	112.0 4.41	118.0 4.65	3.3 0.13	160.0 6.30	149.0 5.87	4.9 0.19	2.1 0.08	182.5	37.3	0.1056	3.46 7.64
41.275 1.6250	30.162 1.1875	-2.8 -0.11	3.5 0.14	112.0 4.41	118.0 4.65	3.3 0.13	160.0 6.30	150.0 5.91	4.9 0.19	2.1 0.08	182.5	37.3	0.1056	3.54 7.81
31.750 1.2500	19.050 0.7500	34.5 1.36	3.3 0.13	119.0 4.69	128.0 5.04	3.3 0.13	172.0 6.77	154.0 6.06	8.9 0.35	3.3 0.13	113.7	37.5	0.1153	3.09 6.83
48.006 1.8900	40.000 1.5748	-8.1 -0.32	3.5 0.14	113.0 4.45	119.0 4.69	3.0 0.12	168.0 6.61	160.0 6.30	3.6 0.14	1.3 0.05	227.3	41.3	0.1067	4.99 11.01
48.006 1.8900	38.100 1.5000	-8.1 -0.32	3.5 0.14	113.0 4.45	119.0 4.69	3.3 0.13	168.0 6.61	161.0 6.34	3.6 0.14	1.3 0.05	227.3	41.3	0.1067	5.02 11.08

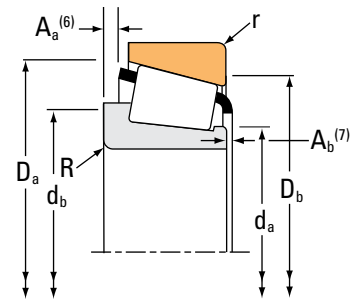
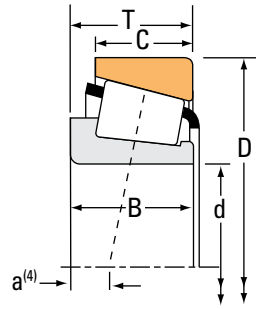
(4) Negative value indicates effective center inside cone (inner-ring) backface.
 (5) These maximum fillet radii will be cleared by the bearing corners.
 (6) Negative value indicates cage extends beyond cone (inner-ring) backface.
 (7) Negative value indicates cage that does not extend beyond cone (inner-ring) front face.

Continued on next page.

TAPERED ROLLER BEARINGS

SINGLE-ROW • TYPE TS

TYPE TS



Bearing Dimensions			Load Ratings							Part Number		
Bore d	O.D. D	Width T	Dynamic ⁽¹⁾		Factors ⁽²⁾		Dynamic ⁽³⁾		Factors ⁽²⁾	Static	Inner	Outer
			C ₁	e	Y	C ₉₀	C _{a90}	K	C ₀			
mm in.	mm in.	mm in.	N lbf			N lbf	N lbf			N lbf		
101.600 4.0000	190.500 7.5000	57.150 2.2500	458000 103000	0.33	1.79	119000 26700	68000 15300	1.74		630000 142000	861	854
101.600 4.0000	190.500 7.5000	57.150 2.2500	534000 120000	0.33	1.79	138000 31100	79300 17800	1.74		692000 156000	HH221449	HH221410
101.600 4.0000	190.500 7.5000	57.150 2.2500	534000 120000	0.33	1.79	138000 31100	79300 17800	1.74		692000 156000	HH221449A	HH221410
101.600 4.0000	200.000 7.8740	52.761 2.0772	482000 108000	0.63	0.95	125000 28100	135000 30400	0.92		519000 117000	98400	98788
101.600 4.0000	212.725 8.3750	66.675 2.6250	572000 129000	0.33	1.84	148000 33300	82700 18600	1.79		786000 177000	941	932
101.600 4.0000	212.725 8.3750	66.675 2.6250	680000 153000	0.33	1.84	176000 39600	98300 22100	1.79		906000 204000	HH224335	HH224310
101.600 4.0000	214.312 8.4375	55.562 2.1875	557000 125000	0.67	0.89	144000 32500	167000 37500	0.87		610000 137000	H924033	H924010
101.600 4.0000	214.975 8.4636	64.798 2.5511	680000 153000	0.33	1.84	176000 39600	98300 22100	1.79		906000 204000	HH224335	HH224314
101.600 4.0000	250.825 9.8750	76.200 3.0000	828000 186000	0.70	0.86	215000 48200	257000 57800	0.84		827000 186000	HH923649	HH923611
103.188 4.0625	171.450 6.7500	41.275 1.6250	265000 59500	0.47	1.28	68600 15400	55300 12400	1.24		386000 86700	689	674
104.775 4.1250	142.083 5.5938	15.875 0.6250	61400 13800	0.39	1.53	15900 3580	10700 2400	1.49		107000 24000	LL521845	LL521810
104.775 4.1250	180.975 7.1250	47.625 1.8750	346000 77800	0.39	1.56	89700 20200	59200 13300	1.51		495000 111000	782	772
104.775 4.1250	180.975 7.1250	47.625 1.8750	346000 77800	0.39	1.56	89700 20200	59200 13300	1.51		495000 111000	786	772
104.775 4.1250	180.975 7.1250	47.625 1.8750	346000 77800	0.39	1.56	89700 20200	59200 13300	1.51		495000 111000	787	772
104.775 4.1250	190.500 7.5000	47.625 1.8750	364000 81700	0.42	1.44	94300 21200	67100 15100	1.40		543000 122000	71412	71750
106.362 4.1875	165.100 6.5000	36.512 1.4375	226000 50900	0.50	1.21	58700 13200	50000 11200	1.18		355000 79700	56418	56650
106.975 4.2116	146.975 5.7864	28.500 1.1220	171000 38400	0.27	2.23	44300 9960	20400 4590	2.17		285000 64100	LM121349	LM121310

⁽¹⁾Based on 1 x 10⁶ revolutions L₁₀ life, for the ISO life-calculation method.

⁽²⁾Consult your Timken engineer for instructions on use or review the Timken Engineering Manual on timken.com/catalogs.

⁽³⁾Based on 90 x 10⁶ revolutions L₁₀ life, for The Timken Company life-calculation method. C₉₀ and C_{a90} are radial and thrust values.

Bearing Dimensions											Geometry Factors			Bearing Weight
Width B	Width C	Eff. Ctr. a ⁽⁴⁾	Shaft			Housing			Cage		G ₁	G ₂	C _g	
			Max Shaft Fillet Radius R ⁽⁵⁾	Backing Shoulder Dia. d _a	Backing Shoulder Dia. d _b	Max Housing Fillet Radius r ⁽⁵⁾	Backing Shoulder Dia. D _a	Backing Shoulder Dia. D _b	A _a ⁽⁶⁾	A _b ⁽⁷⁾				
mm in.	mm in.	mm in.	mm in.	mm in.	mm in.	mm in.	mm in.	mm in.	mm in.	mm in.				kg lbs.
57.531 2.2650	44.450 1.7500	-15.2 -0.60	8.0 0.31	114.0 4.49	129.0 5.08	3.3 0.13	174.0 6.85	170.0 6.69	5.5 0.22	0.7 0.03	264.1	44.9	0.1072	6.83 15.07
57.531 2.2650	46.038 1.8125	-15.0 -0.59	8.0 0.31	115.9 4.56	131.0 5.16	3.3 0.13	179.0 7.05	171.0 6.73	2.5 0.10	3.2 0.13	265.6	28.4	0.1072	6.97 15.38
57.531 2.2650	46.038 1.8125	-15.0 -0.59	3.5 0.14	115.9 4.56	122.0 4.80	3.3 0.13	179.0 7.05	171.0 6.73	2.5 0.10	3.2 0.13	265.6	28.4	0.1072	7.00 15.42
49.212 1.9375	34.925 1.3750	1.3 0.05	3.5 0.14	120.6 4.75	128.0 5.04	3.3 0.13	188.0 7.40	174.0 6.85	8.6 0.34	5.4 0.22	203.4	37.5	0.1197	6.75 14.89
66.675 2.6250	53.975 2.1250	-19.8 -0.78	7.0 0.28	117.0 4.61	130.0 5.12	3.3 0.13	193.1 7.60	187.0 7.36	6.6 0.26	1.3 0.05	338.6	39.8	0.1153	10.96 24.17
66.675 2.6250	53.975 2.1250	-18.8 -0.74	7.0 0.28	121.0 4.76	132.0 5.20	3.3 0.13	201.7 7.94	192.0 7.56	4.8 0.19	2.9 0.12	366.6	47.9	0.1182	11.07 24.41
52.388 2.0625	39.688 1.5625	6.9 0.27	3.5 0.14	128.0 5.04	132.0 5.20	3.3 0.13	205.0 8.07	186.0 7.32	6.6 0.26	3.4 0.14	245.6	32.2	0.1299	8.97 19.79
66.675 2.6250	50.800 2.0000	-18.8 -0.74	7.0 0.28	121.0 4.76	132.0 5.20	3.3 0.13	201.2 7.92	192.0 7.56	4.8 0.19	2.9 0.12	366.6	47.9	0.1182	11.18 24.65
73.025 2.8750	50.800 2.0000	-3.3 -0.13	6.4 0.25	130.8 5.15	149.0 5.87	3.3 0.13	228.8 9.01	210.0 8.27	15.1 0.59	4.6 0.19	282.1	35.2	0.1370	17.11 37.71
41.275 1.6250	30.162 1.1875	-2.8 -0.11	3.5 0.14	113.5 4.46	123.0 4.84	3.3 0.13	160.0 6.30	150.0 5.91	4.9 0.19	2.1 0.08	182.5	37.3	0.1056	3.46 7.62
15.083 0.5938	11.908 0.4688	7.4 0.29	1.5 0.06	111.0 4.37	113.0 4.45	1.5 0.06	137.0 5.39	135.0 5.31	0.7 0.03	2.2 0.09	104.7	110.1	0.1179	0.68 1.50
48.006 1.8900	38.100 1.5000	-8.1 -0.32	3.5 0.14	116.0 4.57	122.0 4.80	3.3 0.13	168.0 6.61	161.0 6.34	3.6 0.14	1.3 0.05	227.3	41.3	0.1067	4.83 10.65
48.006 1.8900	38.100 1.5000	-8.1 -0.32	6.4 0.25	116.0 4.57	128.0 5.04	3.3 0.13	168.0 6.61	161.0 6.34	3.6 0.14	1.3 0.05	227.3	41.3	0.1067	4.79 10.57
48.006 1.8900	38.100 1.5000	-8.1 -0.32	7.0 0.28	116.0 4.57	129.0 5.08	3.3 0.13	168.0 6.61	161.0 6.34	3.6 0.14	1.3 0.05	227.3	41.3	0.1067	4.77 10.53
49.212 1.9375	34.925 1.3750	-6.6 -0.26	3.5 0.14	118.0 4.65	124.0 4.88	3.3 0.13	181.0 7.13	171.0 6.73	5.3 0.21	1.5 0.06	269.2	49.5	0.1156	5.78 12.75
36.512 1.4375	26.988 1.0625	2.0 0.08	3.5 0.14	116.0 4.57	122.0 4.80	3.3 0.13	159.0 6.26	149.0 5.87	3.9 0.15	1.5 0.06	190.9	47.7	0.1584	2.71 5.96
28.000 1.1024	24.000 0.9449	-3.8 -0.15	2.3 0.09	112.0 4.41	116.0 4.57	2.3 0.09	142.0 5.59	138.0 5.43	0.5 0.02	2.4 0.10	195.2	75.6	0.1302	1.33 2.92

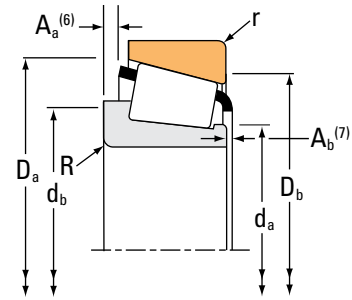
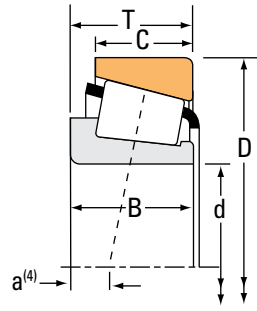
⁽⁴⁾Negative value indicates effective center inside cone (inner-ring) backface.
⁽⁵⁾These maximum fillet radii will be cleared by the bearing corners.
⁽⁶⁾Negative value indicates cage extends beyond cone (inner-ring) backface.
⁽⁷⁾Negative value indicates cage that does not extend beyond cone (inner-ring) front face.

Continued on next page.

TAPERED ROLLER BEARINGS

SINGLE-ROW • TYPE TS

TYPE TS



Bearing Dimensions			Load Ratings							Part Number		
Bore d	O.D. D	Width T	Dynamic ⁽¹⁾		Factors ⁽²⁾		Dynamic ⁽³⁾		Factors ⁽²⁾	Static	Inner	Outer
			C ₁	e	Y	C ₉₀	C _{a90}	K	C ₀			
mm in.	mm in.	mm in.	N lbf			N lbf	N lbf		N lbf			
107.950 4.2500	142.083 5.5938	15.875 0.6250	70400 15800	0.39	1.53	18200 4100	12200 2750	1.49	107000 24000		LL521849C	LL521810
107.950 4.2500	146.050 5.7500	21.433 0.8438	88900 20000	0.39	1.53	23100 5180	15500 3480	1.49	175000 39400		L521949	L521910
107.950 4.2500	152.400 6.0000	21.433 0.8438	88900 20000	0.39	1.53	23100 5180	15500 3480	1.49	175000 39400		L521949	L521914
107.950 4.2500	158.750 6.2500	23.020 0.9063	137000 30700	0.61	0.99	35400 7960	36700 8250	0.96	179000 40100		37425	37625
107.950 4.2500	159.987 6.2987	34.925 1.3750	232000 52200	0.40	1.49	60100 13500	41400 9300	1.45	357000 80300		LM522546	LM522510
107.950 4.2500	161.925 6.3750	34.925 1.3750	192000 43200	0.51	1.19	49800 11200	43100 9680	1.16	308000 69200		48190	48120
107.950 4.2500	165.100 6.5000	36.512 1.4375	226000 50900	0.50	1.21	58700 13200	50000 11200	1.18	355000 79700		56425	56650
107.950 4.2500	165.100 6.5000	36.512 1.4375	226000 50900	0.50	1.21	58700 13200	50000 11200	1.18	355000 79700		56426	56650
107.950 4.2500	168.275 6.6250	36.512 1.4375	226000 50900	0.50	1.21	58700 13200	50000 11200	1.18	355000 79700		56425	56662
107.950 4.2500	171.450 6.7500	34.000 1.3386	233000 52500	0.47	1.27	60500 13600	49000 11000	1.24	268000 60300		67425	67675
107.950 4.2500	190.500 7.5000	47.625 1.8750	364000 81700	0.42	1.44	94300 21200	67100 15100	1.40	543000 122000		71425	71750
107.950 4.2500	212.725 8.3750	66.675 2.6250	572000 129000	0.33	1.84	148000 33300	82700 18600	1.79	786000 177000		936	932
107.950 4.2500	212.725 8.3750	66.675 2.6250	680000 153000	0.33	1.84	176000 39600	98300 22100	1.79	906000 204000		HH224340	HH224310
109.538 4.3125	158.750 6.2500	23.020 0.9063	115000 25900	0.61	0.99	29900 6710	31000 6960	0.96	179000 40100		37431	37625
109.538 4.3125	158.750 6.2500	23.020 0.9063	137000 30700	0.61	0.99	35400 7960	36700 8250	0.96	179000 40100		37431A	37625
109.952 4.3288	190.500 7.5000	47.625 1.8750	364000 81700	0.42	1.44	94300 21200	67100 15100	1.40	543000 122000		71432	71750
109.975 4.3297	179.975 7.0856	41.275 1.6250	275000 61800	0.52	1.16	71200 16000	62900 14100	1.13	419000 94200		64432	64708

⁽¹⁾Based on 1×10^6 revolutions L_{10} life, for the ISO life-calculation method.

⁽²⁾Consult your Timken engineer for instructions on use or review the Timken Engineering Manual on timken.com/catalogs.

⁽³⁾Based on 90×10^6 revolutions L_{10} life, for The Timken Company life-calculation method. C_{90} and C_{a90} are radial and thrust values.

Bearing Dimensions											Geometry Factors			Bearing Weight
Width B	Width C	Eff. Ctr. a ⁽⁴⁾	Shaft			Housing			Cage		G ₁	G ₂	C _g	
			Max Shaft Fillet Radius R ⁽⁵⁾	Backing Shoulder Dia. d _a	Backing Shoulder Dia. d _b	Max Housing Fillet Radius r ⁽⁵⁾	Backing Shoulder Dia. D _a	Backing Shoulder Dia. D _b	A _a ⁽⁶⁾	A _b ⁽⁷⁾				
mm in.	mm in.	mm in.	mm in.	mm in.	mm in.	mm in.	mm in.	mm in.	mm in.	mm in.				kg lbs.
15.083 0.5938	11.908 0.4688	7.4 0.29	1.5 0.06	113.0 4.45	115.0 4.53	1.5 0.06	137.0 5.39	135.0 5.31	0.7 0.03	2.2 0.09	104.7	110.1	0.1179	0.62 1.37
21.433 0.8438	16.670 0.6563	4.8 0.19	1.5 0.06	114.0 4.49	116.0 4.57	1.5 0.06	141.0 5.55	136.0 5.35	0.7 0.03	1.6 0.07	152.1	107.9	0.1346	0.98 2.17
21.433 0.8438	16.670 0.6563	4.8 0.19	1.5 0.06	114.0 4.49	116.0 4.57	1.5 0.06	144.0 5.67	139.0 5.47	0.7 0.03	1.6 0.07	152.1	107.9	0.1346	1.18 2.60
21.438 0.8440	15.875 0.6250	13.7 0.54	3.5 0.14	115.0 4.53	122.0 4.80	3.3 0.13	152.0 5.98	143.0 5.63	2.5 0.10	3.0 0.12	123.7	57.1	0.1443	1.37 3.01
34.925 1.3750	26.988 1.0625	-1.5 -0.06	3.5 0.14	116.0 4.57	122.0 4.80	3.3 0.13	154.0 6.06	146.0 5.75	2.4 0.09	1.4 0.06	231.6	63.4	0.1576	2.34 5.15
34.925 1.3750	26.988 1.0625	3.8 0.15	3.5 0.14	116.0 4.57	122.0 4.80	3.3 0.13	156.0 6.14	146.0 5.75	2.8 0.11	0.8 0.03	180.1	51.0	0.1558	2.34 5.17
36.512 1.4375	26.988 1.0625	2.0 0.08	3.5 0.14	117.0 4.61	123.0 4.84	3.3 0.13	159.0 6.26	149.0 5.87	3.9 0.15	1.5 0.06	190.9	47.7	0.1584	2.63 5.79
36.512 1.4375	26.988 1.0625	2.0 0.08	8.0 0.31	117.0 4.61	132.0 5.20	3.3 0.13	159.0 6.26	149.0 5.87	3.9 0.15	1.5 0.06	190.9	47.7	0.1584	2.60 5.73
36.512 1.4375	26.988 1.0625	2.0 0.08	3.5 0.14	117.0 4.61	123.0 4.84	3.3 0.13	161.0 6.34	151.0 5.94	3.9 0.15	1.5 0.06	190.9	47.7	0.1584	2.79 6.14
30.162 1.1875	25.268 0.9948	4.6 0.18	3.5 0.14	116.0 4.57	123.0 4.84	3.3 0.13	164.0 6.46	156.0 6.14	3.4 0.13	2.1 0.09	151.5	50.5	0.0987	2.54 5.58
49.212 1.9375	34.925 1.3750	-6.6 -0.26	3.6 0.14	120.0 4.72	126.0 4.96	3.3 0.13	181.0 7.13	171.0 6.73	5.3 0.21	1.5 0.06	269.2	49.5	0.1156	5.58 12.32
66.675 2.6250	53.975 2.1250	-19.8 -0.78	8.0 0.31	122.0 4.80	137.0 5.39	3.3 0.13	193.1 7.60	187.0 7.36	6.6 0.26	1.3 0.05	338.6	39.8	0.1153	10.40 22.92
66.675 2.6250	53.975 2.1250	-18.8 -0.74	8.0 0.31	126.0 4.96	139.0 5.47	3.3 0.13	201.7 7.94	192.0 7.56	4.8 0.19	2.9 0.12	366.6	47.9	0.1182	10.48 23.10
21.438 0.8440	15.875 0.6250	13.7 0.54	3.5 0.14	116.0 4.57	123.0 4.84	3.3 0.13	152.0 5.98	143.0 5.63	2.5 0.10	3.0 0.12	123.7	57.1	0.1443	1.33 2.93
21.438 0.8440	15.875 0.6250	13.7 0.54	5.0 0.20	117.0 4.61	126.0 4.96	3.3 0.13	152.0 5.98	143.0 5.63	2.5 0.10	3.0 0.12	123.7	57.1	0.1443	1.32 2.90
49.212 1.9375	34.925 1.3750	-6.6 -0.26	3.5 0.14	122.0 4.80	128.0 5.04	3.3 0.13	181.0 7.13	171.0 6.73	5.3 0.21	1.5 0.06	269.2	49.5	0.1156	5.44 12.00
41.275 1.6250	30.162 1.1875	1.3 0.05	3.5 0.14	121.0 4.76	128.0 5.04	3.3 0.13	173.0 6.81	161.0 6.34	5.2 0.20	2.1 0.08	218.8	45.3	0.1153	3.86 8.50

⁽⁴⁾Negative value indicates effective center inside cone (inner-ring) backface.

⁽⁵⁾These maximum fillet radii will be cleared by the bearing corners.

⁽⁶⁾Negative value indicates cage extends beyond cone (inner-ring) backface.

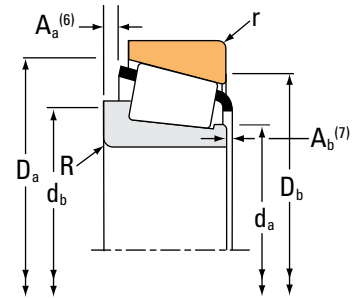
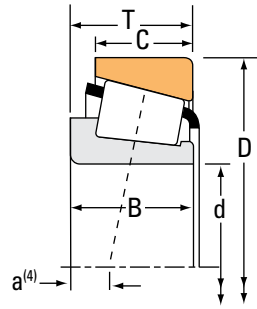
⁽⁷⁾Negative value indicates cage that does not extend beyond cone (inner-ring) front face.

Continued on next page.

TAPERED ROLLER BEARINGS

SINGLE-ROW • TYPE TS

TYPE TS



Bearing Dimensions			Load Ratings							Part Number			
Bore d	O.D. D	Width T	Dynamic ⁽¹⁾		Factors ⁽²⁾		Dynamic ⁽³⁾		Factors ⁽²⁾		Static C ₀	Inner	Outer
			C ₁	e	Y	C ₉₀	C _{a90}	K	N	N			
mm in.	mm in.	mm in.	N lbf			N lbf	N lbf		N lbf				
109.985 4.3301	214.312 8.4375	55.562 2.1875	470000 106000	0.67	0.89	122000 27400	141000 31600	0.87	610000 137000		H924043	H924010	
109.987 4.3302	159.987 6.2987	34.925 1.3750	232000 52200	0.40	1.49	60100 13500	41400 9300	1.45	357000 80300		LM522549	LM522510	
109.987 4.3302	159.987 6.2987	34.925 1.3750	196000 44000	0.40	1.49	50700 11400	34900 7850	1.45	357000 80300		LM522548	LM522510	
109.992 4.3304	177.800 7.0000	41.275 1.6250	275000 61800	0.52	1.16	71200 16000	62900 14100	1.13	419000 94200		64433	64700	
110.000 4.3307	165.000 6.4961	35.000 1.3780	227000 51100	0.50	1.21	58900 13200	50100 11300	1.18	356000 80100		JM822049	JM822010	
110.000 4.3307	180.000 7.0866	47.000 1.8504	371000 83500	0.41	1.48	96300 21600	66900 15000	1.44	554000 125000		JHM522649A	JHM522610	
110.000 4.3307	212.725 8.3750	66.675 2.6250	572000 129000	0.33	1.84	148000 33300	82700 18600	1.79	786000 177000		942	932	
110.333 4.3438	171.450 6.7500	34.000 1.3386	197000 44300	0.47	1.27	51000 11500	41300 9290	1.24	268000 60300		67434	67675	
111.125 4.3750	171.450 6.7500	34.000 1.3386	233000 52500	0.47	1.27	60500 13600	49000 11000	1.24	268000 60300		67437	67675	
111.125 4.3750	190.500 7.5000	47.625 1.8750	364000 81700	0.42	1.44	94300 21200	67100 15100	1.40	543000 122000		71437	71750	
111.125 4.3750	214.312 8.4375	55.562 2.1875	557000 125000	0.67	0.89	144000 32500	167000 37500	0.87	610000 137000		H924045	H924010	
114.300 4.5000	152.400 6.0000	21.433 0.8438	118000 26600	0.41	1.45	30600 6890	21700 4870	1.41	188000 42300		L623149	L623110	
114.300 4.5000	177.800 7.0000	41.275 1.6250	275000 61800	0.52	1.16	71200 16000	62900 14100	1.13	419000 94200		64450	64700	
114.300 4.5000	178.000 7.0079	41.275 1.6250	275000 61800	0.52	1.16	71200 16000	62900 14100	1.13	419000 94200		64450	64701X	
114.300 4.5000	179.975 7.0856	41.275 1.6250	275000 61800	0.52	1.16	71200 16000	62900 14100	1.13	419000 94200		64450	64708	
114.300 4.5000	180.975 7.1250	41.275 1.6250	275000 61800	0.52	1.16	71200 16000	62900 14100	1.13	419000 94200		64450	64713	
114.300 4.5000	190.500 7.5000	47.625 1.8750	364000 81700	0.42	1.44	94300 21200	67100 15100	1.40	543000 122000		71450	71750	

⁽¹⁾Based on 1 x 10⁶ revolutions L₁₀ life, for the ISO life-calculation method.

⁽²⁾Consult your Timken engineer for instructions on use or review the Timken Engineering Manual on timken.com/catalogs.

⁽³⁾Based on 90 x 10⁶ revolutions L₁₀ life, for The Timken Company life-calculation method. C₉₀ and C_{a90} are radial and thrust values.

Bearing Dimensions											Geometry Factors			Bearing Weight
Width B	Width C	Eff. Ctr. a ⁽⁴⁾	Shaft			Housing			Cage		G ₁	G ₂	C _g	
			Max Shaft Fillet Radius R ⁽⁵⁾	Backing Shoulder Dia. d _a	Backing Shoulder Dia. d _b	Max Housing Fillet Radius r ⁽⁵⁾	Backing Shoulder Dia. D _a	Backing Shoulder Dia. D _b	A _a ⁽⁶⁾	A _b ⁽⁷⁾				
mm in.	mm in.	mm in.	mm in.	mm in.	mm in.	mm in.	mm in.	mm in.	mm in.	mm in.				kg lbs.
52.388 2.0625	39.688 1.5625	6.9 0.27	3.5 0.14	131.2 5.16	139.0 5.47	3.3 0.13	205.0 8.07	186.0 7.32	6.6 0.26	3.4 0.14	245.6	32.2	0.1299	8.40 18.53
34.925 1.3750	26.988 1.0625	-1.5 -0.06	3.5 0.14	118.0 4.65	124.0 4.88	3.3 0.13	154.0 6.06	146.0 5.75	2.4 0.09	1.4 0.06	231.6	63.4	0.1576	2.24 4.94
34.925 1.3750	26.988 1.0625	-1.5 -0.06	8.0 0.31	118.0 4.65	133.0 5.24	3.3 0.13	154.0 6.06	146.0 5.75	2.4 0.09	1.4 0.06	231.6	63.4	0.1576	2.17 4.78
41.275 1.6250	30.162 1.1875	1.3 0.05	3.5 0.14	121.0 4.76	128.0 5.04	3.3 0.13	172.0 6.77	160.0 6.30	5.2 0.20	2.1 0.08	218.8	45.3	0.1153	3.71 8.19
35.000 1.3780	26.500 1.0433	3.0 0.12	3.0 0.12	119.0 4.69	125.0 4.92	2.5 0.10	159.0 6.26	149.0 5.87	2.9 0.11	2.0 0.08	191.5	45.8	0.1585	2.44 5.39
46.000 1.8110	38.000 1.4961	-5.8 -0.23	7.0 0.28	122.0 4.80	138.0 5.43	2.5 0.10	172.0 6.77	162.0 6.38	2.6 0.10	3.9 0.16	259.2	52.1	0.1134	N/A* N/A*
66.675 2.6250	53.975 2.1250	-19.8 -0.78	6.4 0.25	124.0 4.88	136.0 5.35	3.3 0.13	193.1 7.60	187.0 7.36	6.6 0.26	1.3 0.05	338.6	39.8	0.1153	10.26 22.63
30.162 1.1875	25.268 0.9948	4.6 0.18	3.5 0.14	118.0 4.65	124.0 4.88	3.3 0.13	164.0 6.46	156.0 6.14	3.4 0.13	2.1 0.09	151.5	50.5	0.0987	2.44 5.37
30.162 1.1875	25.268 0.9948	4.6 0.18	3.5 0.14	119.0 4.69	125.0 4.92	3.3 0.13	164.0 6.46	156.0 6.14	3.4 0.13	2.1 0.09	151.5	50.5	0.0987	2.41 5.29
49.212 1.9375	34.925 1.3750	-6.6 -0.26	3.6 0.14	123.0 4.84	129.0 5.08	3.3 0.13	181.0 7.13	171.0 6.73	5.3 0.21	1.5 0.06	269.2	49.5	0.1156	5.37 11.85
52.388 2.0625	39.688 1.5625	6.9 0.27	3.5 0.14	131.2 5.16	139.0 5.47	3.3 0.13	205.0 8.07	186.0 7.32	6.6 0.26	3.4 0.14	245.6	32.2	0.1299	8.32 18.35
21.433 0.8438	16.670 0.6563	6.4 0.25	1.5 0.06	120.0 4.72	123.0 4.84	1.5 0.06	147.0 5.79	143.0 5.63	1.0 0.04	1.6 0.07	171.2	122.8	0.1422	1.05 2.31
41.275 1.6250	30.162 1.1875	1.3 0.05	3.5 0.14	125.0 4.92	131.0 5.16	3.3 0.13	172.0 6.77	160.0 6.30	5.2 0.20	2.1 0.08	218.8	45.3	0.1153	3.46 7.64
41.275 1.6250	30.162 1.1875	1.3 0.05	3.5 0.14	125.0 4.92	131.0 5.16	3.0 0.12	172.0 6.77	160.0 6.30	5.2 0.20	2.1 0.08	218.8	45.3	0.1153	3.48 7.68
41.275 1.6250	30.162 1.1875	1.3 0.05	3.5 0.14	125.0 4.92	131.0 5.16	3.3 0.13	173.0 6.81	161.0 6.34	5.2 0.20	2.1 0.08	218.8	45.3	0.1153	3.61 7.96
41.275 1.6250	30.162 1.1875	1.3 0.05	3.5 0.14	125.0 4.92	131.0 5.16	3.3 0.13	173.0 6.81	161.0 6.34	5.2 0.20	2.1 0.08	218.8	45.3	0.1153	3.67 8.11
49.212 1.9375	34.925 1.3750	-6.6 -0.26	3.6 0.14	125.0 4.92	132.0 5.20	3.3 0.13	181.0 7.13	171.0 6.73	5.3 0.21	1.6 0.06	269.2	49.5	0.1156	5.16 11.38

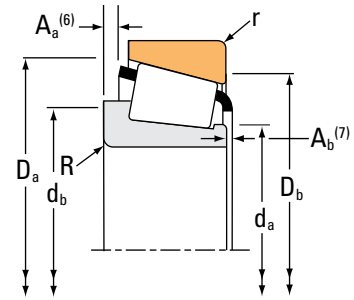
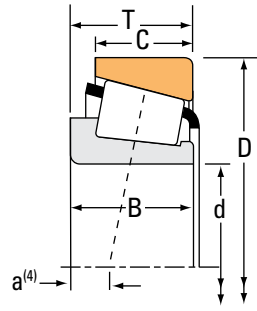
(4) Negative value indicates effective center inside cone (inner-ring) backface.
 (5) These maximum fillet radii will be cleared by the bearing corners.
 (6) Negative value indicates cage extends beyond cone (inner-ring) backface.
 (7) Negative value indicates cage that does not extend beyond cone (inner-ring) front face.
 (*) Contact your Timken engineer for details.

Continued on next page.

TAPERED ROLLER BEARINGS

SINGLE-ROW • TYPE TS

TYPE TS



Bearing Dimensions			Load Ratings							Part Number			
Bore d	O.D. D	Width T	Dynamic ⁽¹⁾		Factors ⁽²⁾		Dynamic ⁽³⁾		Factors ⁽²⁾		Static C ₀	Inner	Outer
			C ₁	e	Y	C ₉₀	C _{a90}	K	N	N			
mm in.	mm in.	mm in.	N lbf			N lbf	N lbf		N lbf				
114.300 4.5000	206.375 8.1250	66.675 2.6250	572000 129000	0.33	1.84	148000 33300	82700 18600	1.79	786000 177000			938	930
114.300 4.5000	212.725 8.3750	66.675 2.6250	680000 153000	0.33	1.84	176000 39600	98300 22100	1.79	906000 204000			HH224346	HH224310
114.300 4.5000	212.725 8.3750	66.675 2.6250	572000 129000	0.33	1.84	148000 33300	82700 18600	1.79	786000 177000			938	932
114.300 4.5000	214.975 8.4636	64.798 2.5511	680000 153000	0.33	1.84	176000 39600	98300 22100	1.79	906000 204000			HH224346	HH224314
114.300 4.5000	228.600 9.0000	53.975 2.1250	586000 132000	0.74	0.81	152000 34200	192000 43100	0.79	673000 151000			HM926740	HM926710
114.300 4.5000	273.050 10.7500	82.550 3.2500	1070000 240000	0.63	0.95	276000 62100	299000 67200	0.92	1080000 243000			HH926744	HH926710
114.300 4.5000	279.400 11.0000	82.550 3.2500	1070000 240000	0.63	0.95	276000 62100	299000 67200	0.92	1080000 243000			HH926744	HH926716
114.975 4.5266	177.800 7.0000	41.275 1.6250	275000 61800	0.52	1.16	71200 16000	62900 14100	1.13	419000 94200			64452A	64700
114.975 4.5266	180.975 7.1250	41.275 1.6250	275000 61800	0.52	1.16	71200 16000	62900 14100	1.13	419000 94200			64452A	64713
114.975 4.5266	212.725 8.3750	66.675 2.6250	680000 153000	0.33	1.84	176000 39600	98300 22100	1.79	906000 204000			HH224349	HH224310
115.000 4.5276	165.000 6.4961	28.000 1.1024	160000 35900	0.46	1.31	41400 9310	32500 7310	1.27	245000 55100			JLM722948	JLM722912
115.087 4.5310	190.500 7.5000	47.625 1.8750	364000 81700	0.42	1.44	94300 21200	67100 15100	1.40	543000 122000			71455	71750
115.087 4.5310	190.500 7.5000	47.625 1.8750	364000 81700	0.42	1.44	94300 21200	67100 15100	1.40	543000 122000			71453	71750
117.475 4.6250	179.975 7.0856	34.925 1.3750	232000 52100	0.50	1.21	60100 13500	51100 11500	1.18	271000 61000			68462	68709
117.475 4.6250	180.975 7.1250	34.925 1.3750	232000 52100	0.50	1.21	60100 13500	51100 11500	1.18	271000 61000			68462	68712
117.475 4.6250	180.975 7.1250	34.925 1.3750	232000 52100	0.50	1.21	60100 13500	51100 11500	1.18	271000 61000			68463	68712
119.964 4.7230	215.900 8.5000	47.625 1.8750	382000 85900	0.49	1.23	99000 22300	82600 18600	1.20	614000 138000			74472	74850

⁽¹⁾Based on 1×10^6 revolutions L_{10} life, for the ISO life-calculation method.

⁽²⁾Consult your Timken engineer for instructions on use or review the Timken Engineering Manual on timken.com/catalogs.

⁽³⁾Based on 90×10^6 revolutions L_{10} life, for The Timken Company life-calculation method. C_{90} and C_{a90} are radial and thrust values.

Bearing Dimensions											Geometry Factors			Bearing Weight
Width B	Width C	Eff. Ctr. a ⁽⁴⁾	Shaft			Housing			Cage		G ₁	G ₂	C _g	
			Max Shaft Fillet Radius R ⁽⁵⁾	Backing Shoulder Dia. d _a	Backing Shoulder Dia. d _b	Max Housing Fillet Radius r ⁽⁵⁾	Backing Shoulder Dia. D _a	Backing Shoulder Dia. D _b	A _a ⁽⁶⁾	A _b ⁽⁷⁾				
mm in.	mm in.	mm in.	mm in.	mm in.	mm in.	mm in.	mm in.	mm in.	mm in.	mm in.				kg lbs.
66.675 2.6250	53.975 2.1250	-19.8 -0.78	7.0 0.28	128.0 5.04	141.0 5.55	3.3 0.13	193.1 7.60	184.0 7.24	6.6 0.26	1.3 0.05	338.6	39.8	0.1153	8.98 19.79
66.675 2.6250	53.975 2.1250	-18.8 -0.74	7.0 0.28	131.0 5.16	143.0 5.63	3.3 0.13	201.7 7.94	192.0 7.56	4.8 0.19	2.9 0.12	366.6	47.9	0.1182	9.92 21.85
66.675 2.6250	53.975 2.1250	-19.8 -0.78	7.0 0.28	128.0 5.04	141.0 5.55	3.3 0.13	193.1 7.60	187.0 7.36	6.6 0.26	1.3 0.05	338.6	39.8	0.1153	9.83 21.67
66.675 2.6250	50.800 2.0000	-18.8 -0.74	7.0 0.28	131.0 5.16	143.0 5.63	3.3 0.13	201.2 7.92	192.0 7.56	4.8 0.19	2.9 0.12	366.6	47.9	0.1182	10.03 22.10
49.428 1.9460	38.100 1.5000	13.5 0.53	3.5 0.14	142.0 5.59	146.0 5.75	3.3 0.13	219.3 8.63	200.0 7.87	9.0 0.35	6.4 0.26	295.4	39.0	0.1416	9.54 21.04
82.550 3.2500	53.975 2.1250	-6.6 -0.26	6.4 0.25	147.2 5.80	164.0 6.46	6.4 0.25	253.3 9.97	230.0 9.06	15.1 0.59	4.1 0.17	384.1	37.8	0.1472	22.09 48.68
82.550 3.2500	53.975 2.1250	-6.6 -0.26	6.4 0.25	147.2 5.80	164.0 6.46	6.4 0.25	253.3 9.97	233.0 9.17	15.1 0.59	4.1 0.17	384.1	37.8	0.1472	23.16 51.05
41.275 1.6250	30.162 1.1875	1.3 0.05	9.0 0.35	125.9 4.96	143.0 5.63	3.3 0.13	172.0 6.77	160.0 6.30	5.2 0.20	2.1 0.08	218.8	45.3	0.1153	3.32 7.34
41.275 1.6250	30.162 1.1875	1.3 0.05	9.0 0.35	125.9 4.96	143.0 5.63	3.3 0.13	173.0 6.81	161.0 6.34	5.2 0.20	2.1 0.08	218.8	45.3	0.1153	3.53 7.80
66.675 2.6250	53.975 2.1250	-18.8 -0.74	7.0 0.28	131.0 5.16	144.0 5.67	3.3 0.13	201.7 7.94	192.0 7.56	4.8 0.19	2.9 0.12	366.6	47.9	0.1182	9.85 21.71
27.000 1.0630	21.000 0.8268	5.6 0.22	3.3 0.13	121.0 4.76	127.0 5.00	3.0 0.12	158.0 6.22	151.0 5.94	2.2 0.08	2.4 0.10	161.0	57.2	0.1449	1.75 3.86
49.212 1.9375	34.925 1.3750	-6.6 -0.26	8.0 0.31	126.0 4.96	141.0 5.55	3.3 0.13	181.0 7.13	171.0 6.73	5.3 0.21	1.5 0.06	269.2	49.5	0.1156	5.02 11.07
49.212 1.9375	34.925 1.3750	-6.6 -0.26	3.5 0.14	126.0 4.96	133.0 5.24	3.3 0.13	181.0 7.13	171.0 6.73	5.3 0.21	1.5 0.06	269.2	49.5	0.1156	5.09 11.23
31.750 1.2500	25.400 1.0000	5.3 0.21	3.5 0.14	125.0 4.92	132.0 5.20	0.8 0.03	172.0 6.77	165.0 6.50	5.1 0.20	2.3 0.09	163.1	51.7	0.1026	2.71 5.98
31.750 1.2500	25.400 1.0000	5.3 0.21	3.5 0.14	125.0 4.92	132.0 5.20	3.3 0.13	172.0 6.77	163.0 6.42	5.1 0.20	2.3 0.09	163.1	51.7	0.1026	2.74 6.06
31.750 1.2500	25.400 1.0000	5.3 0.21	8.0 0.31	125.0 4.92	140.0 5.51	3.3 0.13	172.0 6.77	163.0 6.42	5.1 0.20	2.3 0.09	163.1	51.7	0.1026	2.67 5.89
47.625 1.8750	34.925 1.3750	2.3 0.09	3.5 0.14	136.0 5.35	142.0 5.59	3.3 0.13	208.0 8.19	196.0 7.72	4.8 0.18	2.0 0.08	362.9	68.5	0.1338	7.47 16.47

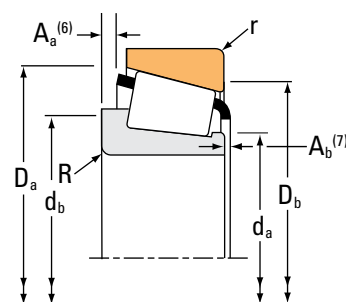
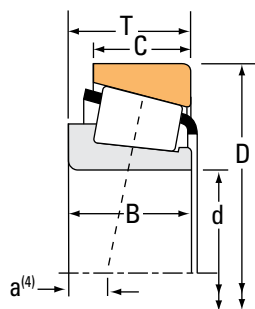
(4) Negative value indicates effective center inside cone (inner-ring) backface.
 (5) These maximum fillet radii will be cleared by the bearing corners.
 (6) Negative value indicates cage extends beyond cone (inner-ring) backface.
 (7) Negative value indicates cage that does not extend beyond cone (inner-ring) front face.

Continued on next page.

TAPERED ROLLER BEARINGS

SINGLE-ROW • TYPE TS

TYPE TS



Bearing Dimensions			Load Ratings							Part Number		
Bore d	O.D. D	Width T	Dynamic ⁽¹⁾		Factors ⁽²⁾		Dynamic ⁽³⁾		Factors ⁽²⁾	Static	Inner	Outer
			C ₁	e	Y	C ₉₀	C _{a90}	K	C ₀			
mm in.	mm in.	mm in.	N lbf			N lbf	N lbf			N lbf		
119.974 4.7234	174.625 6.8750	35.720 1.4063	244000 54900	0.33	1.80	63400 14200	36100 8110	1.76		422000 94900	M224748	M224710
120.000 4.7244	170.000 6.6929	25.400 1.0000	145000 32600	0.46	1.31	37600 8450	29500 6640	1.27		231000 52000	JL724348	JL724314
120.000 4.7244	170.000 6.6929	27.000 1.0630	196000 44100	0.47	1.27	50800 11400	41100 9250	1.24		238000 53500	JP12049	JP12010
120.000 4.7244	170.000 6.6929	27.000 1.0630	196000 44100	0.47	1.27	50800 11400	41100 9250	1.24		238000 53500	JP12049A	JP12010
120.000 4.7244	180.000 7.0866	36.000 1.4173	247000 55500	0.41	1.45	64000 14400	45300 10200	1.41		377000 84700	JM624649	JM624610
120.000 4.7244	215.900 8.5000	47.625 1.8750	382000 85900	0.49	1.23	99000 22300	82600 18600	1.20		614000 138000	74473X	74850
120.000 4.7244	230.000 9.0551	53.975 2.1250	376000 84500	0.74	0.81	97500 21900	123000 27600	0.79		486000 109000	97472X	97905X
120.650 4.7500	161.925 6.3750	21.433 0.8438	97500 21900	0.43	1.38	25300 5680	18800 4230	1.34		206000 46400	L624549	L624514
120.650 4.7500	166.688 6.5625	25.400 1.0000	145000 32600	0.46	1.31	37600 8450	29500 6640	1.27		231000 52000	L724349	L724310
120.650 4.7500	169.862 6.6875	25.400 1.0000	143000 32100	0.33	1.80	37000 8320	21100 4740	1.76		273000 61400	L225842	L225810
120.650 4.7500	172.242 6.7812	35.720 1.4063	244000 54900	0.33	1.80	63400 14200	36100 8110	1.76		422000 94900	M224749	M224711
120.650 4.7500	174.625 6.8750	35.720 1.4063	244000 54900	0.33	1.80	63400 14200	36100 8110	1.76		422000 94900	M224749	M224710
120.650 4.7500	174.625 6.8750	35.720 1.4063	244000 54900	0.33	1.80	63400 14200	36100 8110	1.76		422000 94900	M224749	M224712
120.650 4.7500	180.975 7.1250	25.400 1.0000	143000 32100	0.33	1.80	37000 8320	21100 4740	1.76		273000 61400	L225842	L225818
120.650 4.7500	182.562 7.1875	39.688 1.5625	268000 60200	0.31	1.97	69400 15600	36300 8160	1.91		493000 111000	48282	48220
120.650 4.7500	190.500 7.5000	46.038 1.8125	362000 81300	0.43	1.41	93700 21100	68500 15400	1.37		543000 122000	HM624749	HM624710
120.650 4.7500	199.975 7.8730	46.038 1.8125	362000 81300	0.43	1.41	93700 21100	68500 15400	1.37		543000 122000	HM624749	HM624716

⁽¹⁾Based on 1 x 10⁶ revolutions L₁₀ life, for the ISO life-calculation method.

⁽²⁾Consult your Timken engineer for instructions on use or review the Timken Engineering Manual on timken.com/catalogs.

⁽³⁾Based on 90 x 10⁶ revolutions L₁₀ life, for The Timken Company life-calculation method. C₉₀ and C_{a90} are radial and thrust values.

Bearing Dimensions											Geometry Factors			Bearing Weight
Width B	Width C	Eff. Ctr. a ⁽⁴⁾	Shaft			Housing			Cage		G ₁	G ₂	C _g	
			Max Shaft Fillet Radius R ⁽⁵⁾	Backing Shoulder Dia. d _a	Backing Shoulder Dia. d _b	Max Housing Fillet Radius r ⁽⁵⁾	Backing Shoulder Dia. D _a	Backing Shoulder Dia. D _b	A _a ⁽⁶⁾	A _b ⁽⁷⁾				
mm in.	mm in.	mm in.	mm in.	mm in.	mm in.	mm in.	mm in.	mm in.	mm in.	mm in.				kg lbs.
36.512 1.4375	27.783 1.0938	-3.6 -0.14	3.5 0.14	129.0 5.08	134.0 5.28	1.5 0.06	167.9 6.61	162.0 6.38	3.7 0.14	0.5 0.02	279.1	86.6	0.1575	2.71 5.98
25.400 1.0000	19.050 0.7500	7.9 0.31	3.3 0.13	127.0 5.00	132.0 5.20	3.3 0.13	163.0 6.42	156.0 6.14	2.7 0.10	1.2 0.05	170.2	70.6	0.1472	1.62 3.56
25.000 0.9843	19.500 0.7677	7.9 0.31	3.0 0.12	127.0 5.00	133.0 5.24	3.0 0.12	164.5 6.48	157.0 6.18	2.8 0.11	3.7 0.15	157.8	76.7	0.1451	1.70 3.76
25.000 0.9843	19.500 0.7677	7.9 0.31	6.0 0.24	127.0 5.00	139.0 5.47	3.0 0.12	164.5 6.48	157.0 6.18	2.8 0.11	3.7 0.15	157.8	76.7	*	1.69 3.72
36.000 1.4173	26.000 1.0236	0.0 0.00	3.5 0.14	128.0 5.04	135.0 5.31	1.5 0.06	173.0 6.81	166.0 6.54	3.5 0.14	2.7 0.11	226.8	61.6	0.1084	2.92 6.46
47.625 1.8750	34.925 1.3750	2.3 0.09	4.0 0.16	137.0 5.39	144.0 5.67	3.3 0.13	208.0 8.19	196.0 7.72	4.8 0.18	2.0 0.08	362.9	68.5	0.1338	7.46 16.45
49.428 1.9460	38.100 1.5000	13.2 0.52	3.5 0.14	140.0 5.51	145.0 5.71	3.3 0.13	213.0 8.38	198.0 7.80	8.2 0.32	4.8 0.19	237.1	44.6	0.1311	8.92 19.66
21.433 0.8438	16.670 0.6563	8.4 0.33	1.5 0.06	127.0 5.00	129.0 5.08	1.5 0.06	156.0 6.14	151.0 5.94	1.1 0.04	1.7 0.07	195.2	139.1	0.1509	1.21 2.67
25.400 1.0000	19.050 0.7500	7.9 0.31	3.3 0.13	128.0 5.04	133.0 5.24	3.3 0.13	161.0 6.34	154.0 6.06	2.7 0.10	1.2 0.05	170.2	70.6	0.1472	1.49 3.27
26.195 1.0313	20.638 0.8125	2.5 0.10	1.5 0.06	129.0 5.08	131.0 5.16	1.5 0.06	164.0 6.46	160.0 6.30	0.7 0.02	1.6 0.07	253.2	134.6	0.1511	1.84 4.05
36.512 1.4375	27.783 1.0938	-3.6 -0.14	3.5 0.14	129.0 5.08	135.0 5.31	1.5 0.06	166.9 6.57	162.0 6.38	3.7 0.14	0.5 0.02	279.1	86.6	0.1575	2.53 5.59
36.512 1.4375	27.783 1.0938	-3.6 -0.14	3.5 0.14	129.0 5.08	135.0 5.31	1.5 0.06	167.9 6.61	162.0 6.38	3.7 0.14	0.5 0.02	279.1	86.6	0.1575	2.67 5.90
36.512 1.4375	27.783 1.0938	-3.6 -0.14	3.5 0.14	129.0 5.08	135.0 5.31	3.3 0.13	167.9 6.61	161.0 6.34	3.7 0.14	0.5 0.02	279.1	86.6	0.1575	2.67 5.90
26.195 1.0313	20.638 0.8125	2.5 0.10	1.5 0.06	129.0 5.08	131.0 5.16	1.5 0.06	166.0 6.54	164.0 6.46	0.7 0.02	1.6 0.07	253.2	134.6	0.1511	2.33 5.13
38.100 1.5000	33.338 1.3125	-5.6 -0.22	3.5 0.14	131.0 5.16	137.0 5.39	3.3 0.13	176.0 6.93	168.0 6.61	1.8 0.07	3.3 0.13	353.0	91.4	0.1138	3.62 7.99
46.038 1.8125	34.925 1.3750	-3.8 -0.15	3.5 0.14	132.0 5.20	138.0 5.43	1.5 0.06	184.0 7.24	174.0 6.85	3.7 0.14	2.6 0.11	278.8	51.5	0.1178	4.61 10.16
46.038 1.8125	34.925 1.3750	-3.8 -0.15	3.5 0.14	132.0 5.20	138.0 5.43	1.5 0.06	185.0 7.28	178.0 7.01	3.7 0.14	2.6 0.11	278.8	51.5	0.1178	5.40 11.90

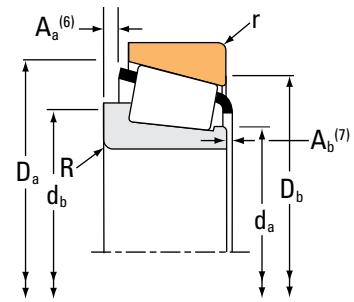
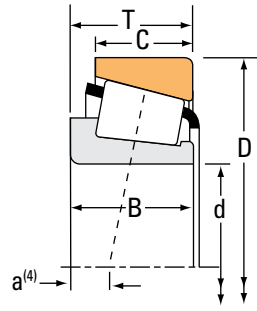
(4) Negative value indicates effective center inside cone (inner-ring) backface.
 (5) These maximum fillet radii will be cleared by the bearing corners.
 (6) Negative value indicates cage extends beyond cone (inner-ring) backface.
 (7) Negative value indicates cage that does not extend beyond cone (inner-ring) front face.
 (*) Contact your Timken engineer for details.

Continued on next page.

TAPERED ROLLER BEARINGS

SINGLE-ROW • TYPE TS

TYPE TS



Bearing Dimensions			Load Ratings							Part Number		
Bore d	O.D. D	Width T	Dynamic ⁽¹⁾		Factors ⁽²⁾		Dynamic ⁽³⁾		Factors ⁽²⁾	Static	Inner	Outer
			C ₁	e	Y	C ₉₀	C _{a90}	K	C ₀			
mm in.	mm in.	mm in.	N lbf			N lbf	N lbf		N lbf			
120.650 4.7500	206.375 8.1250	47.625 1.8750	378000 85000	0.46	1.31	98000 22000	77000 17300	1.27	593000 133000		795	792
120.650 4.7500	234.950 9.2500	63.500 2.5000	629000 141000	0.37	1.62	163000 36700	103000 23200	1.58	931000 209000		95475	95925
120.650 4.7500	254.000 10.0000	77.788 3.0625	910000 205000	0.32	1.87	236000 53000	130000 29200	1.82	1240000 279000		HH228340	HH228310
120.650 4.7500	259.975 10.2352	77.788 3.0625	910000 205000	0.32	1.87	236000 53000	130000 29200	1.82	1240000 279000		HH228340	HH228318
120.650 4.7500	273.050 10.7500	82.550 3.2500	1070000 240000	0.63	0.95	276000 62100	299000 67200	0.92	1080000 243000		HH926749	HH926710
123.825 4.8750	182.562 7.1875	39.688 1.5625	268000 60200	0.31	1.97	69400 15600	36300 8160	1.91	493000 111000		48286	48220
124.943 4.9190	234.950 9.2500	63.500 2.5000	629000 141000	0.37	1.62	163000 36700	103000 23200	1.58	931000 209000		95491	95925
125.000 4.9213	175.000 6.8898	25.400 1.0000	150000 33700	0.48	1.26	38900 8750	31700 7130	1.23	246000 55300		JL725346	JL725316
125.298 4.9330	228.600 9.0000	53.975 2.1250	586000 132000	0.74	0.81	152000 34200	192000 43100	0.79	673000 151000		HM926745	HM926710
127.000 5.0000	165.895 6.5313	18.258 0.7188	90200 20300	0.33	1.80	23400 5260	13300 2990	1.76	153000 34400		LL225749	LL225710
127.000 5.0000	169.862 6.6875	25.400 1.0000	143000 32100	0.33	1.80	37000 8320	21100 4740	1.76	273000 61400		L225849	L225810
127.000 5.0000	171.450 6.7500	25.400 1.0000	150000 33700	0.48	1.26	38900 8750	31700 7130	1.23	246000 55300		L725349	L725311
127.000 5.0000	174.625 6.8750	36.512 1.4375	220000 49500	0.31	1.95	57100 12800	30000 6750	1.90	413000 92900		LM125748	LM125711
127.000 5.0000	180.975 7.1250	25.400 1.0000	143000 32100	0.33	1.80	37000 8320	21100 4740	1.76	273000 61400		L225849	L225818
127.000 5.0000	182.562 7.1875	39.688 1.5625	268000 60200	0.31	1.97	69400 15600	36300 8160	1.91	493000 111000		48290	48220
127.000 5.0000	196.850 7.7500	46.038 1.8125	368000 82600	0.34	1.74	95300 21400	56100 12600	1.70	625000 141000		67388	67322
127.000 5.0000	203.200 8.0000	46.038 1.8125	368000 82600	0.34	1.74	95300 21400	56100 12600	1.70	625000 141000		67388	67320

⁽¹⁾Based on 1 x 10⁶ revolutions L₁₀ life, for the ISO life-calculation method.

⁽²⁾Consult your Timken engineer for instructions on use or review the Timken Engineering Manual on timken.com/catalogs.

⁽³⁾Based on 90 x 10⁶ revolutions L₁₀ life, for The Timken Company life-calculation method. C₉₀ and C_{a90} are radial and thrust values.

Bearing Dimensions											Geometry Factors			Bearing Weight
Width B	Width C	Eff. Ctr. a ⁽⁴⁾	Shaft			Housing			Cage		G ₁	G ₂	C _g	
			Max Shaft Fillet Radius R ⁽⁵⁾	Backing Shoulder Dia. d _a	Backing Shoulder Dia. d _b	Max Housing Fillet Radius r ⁽⁵⁾	Backing Shoulder Dia. D _a	Backing Shoulder Dia. D _b	A _a ⁽⁶⁾	A _b ⁽⁷⁾				
mm in.	mm in.	mm in.	mm in.	mm in.	mm in.	mm in.	mm in.	mm in.	mm in.	mm in.				kg lbs.
47.625 1.8750	34.925 1.3750	-1.8 -0.07	3.3 0.13	134.0 5.28	139.0 5.47	3.3 0.13	196.0 7.72	186.0 7.32	5.3 0.21	2.8 0.11	326.4	62.0	0.1269	6.34 13.99
63.500 2.5000	49.212 1.9375	-14.0 -0.55	6.4 0.25	137.0 5.39	149.0 5.87	3.3 0.13	217.0 8.54	209.0 8.23	6.4 0.25	3.8 0.15	453.9	59.4	0.1323	12.35 27.25
82.550 3.2500	61.912 2.4375	-23.4 -0.92	9.7 0.38	142.0 5.59	158.0 6.22	6.4 0.25	233.6 9.20	223.0 8.78	7.0 0.27	0.0 0.00	529.8	44.8	0.1329	18.57 40.95
82.550 3.2500	61.912 2.4375	-23.4 -0.92	9.7 0.38	142.0 5.59	158.0 6.22	4.0 0.16	233.6 9.20	228.0 8.98	7.0 0.27	0.0 0.00	529.8	44.8	0.1329	19.85 43.77
82.550 3.2500	53.975 2.1250	-6.6 -0.26	6.4 0.25	147.2 5.80	168.0 6.61	6.4 0.25	253.3 9.97	230.0 9.06	15.1 0.59	4.1 0.17	384.1	37.8	0.1472	21.33 47.01
38.100 1.5000	33.338 1.3125	-5.6 -0.22	3.5 0.14	133.0 5.24	139.0 5.47	3.3 0.13	176.0 6.93	168.0 6.61	1.8 0.07	3.3 0.13	353.0	91.4	0.1138	3.44 7.58
63.500 2.5000	49.212 1.9375	-14.0 -0.55	6.4 0.25	140.0 5.51	152.0 5.98	3.3 0.13	217.0 8.54	209.0 8.23	6.4 0.25	3.8 0.15	453.9	59.4	0.1323	11.94 26.34
25.400 1.0000	18.288 0.7200	9.1 0.36	3.3 0.13	133.0 5.24	138.0 5.43	3.3 0.13	168.0 6.61	161.0 6.34	3.0 0.11	1.5 0.06	186.6	77.7	0.1535	1.69 3.72
49.428 1.9460	38.100 1.5000	13.5 0.53	3.5 0.14	143.0 5.63	154.0 6.06	3.3 0.13	219.3 8.63	200.0 7.87	9.0 0.35	6.4 0.26	295.4	39.0	0.1416	8.74 19.26
17.462 0.6875	13.495 0.5313	6.1 0.24	1.5 0.06	133.0 5.24	135.0 5.31	1.5 0.06	160.0 6.30	158.0 6.22	1.3 0.05	2.1 0.09	163.9	140.7	0.1297	0.92 2.02
26.195 1.0313	20.638 0.8125	2.5 0.10	1.5 0.06	134.0 5.28	136.0 5.35	1.5 0.06	164.0 6.46	160.0 6.30	0.7 0.02	1.6 0.07	253.2	134.6	0.1511	1.58 3.49
25.400 1.0000	18.288 0.7200	9.1 0.36	3.3 0.13	134.0 5.28	139.0 5.47	3.3 0.13	167.0 6.57	160.0 6.30	3.0 0.11	1.5 0.06	186.6	77.7	0.1535	1.50 3.30
36.512 1.4375	31.750 1.2500	-4.3 -0.17	3.3 0.13	134.9 5.31	139.9 5.51	3.3 0.13	167.9 6.61	161.0 6.34	2.2 0.08	0.6 0.03	314.8	110.2	0.1594	2.54 5.60
26.195 1.0313	20.638 0.8125	2.5 0.10	1.5 0.06	134.0 5.28	136.0 5.35	1.5 0.06	166.0 6.54	164.0 6.46	0.7 0.02	1.6 0.07	253.2	134.6	0.1511	2.07 4.57
38.100 1.5000	33.338 1.3125	-5.6 -0.22	3.5 0.14	135.0 5.31	141.0 5.55	3.3 0.13	176.0 6.93	168.0 6.61	1.8 0.07	3.3 0.13	353.0	91.4	0.1138	3.26 7.17
46.038 1.8125	38.100 1.5000	-6.4 -0.25	3.5 0.14	138.0 5.43	144.0 5.67	3.3 0.13	189.0 7.44	180.0 7.09	4.2 0.16	1.4 0.06	383.7	70.1	0.1220	5.05 11.13
46.038 1.8125	38.100 1.5000	-6.4 -0.25	3.5 0.14	138.0 5.43	144.0 5.67	3.3 0.13	191.0 7.52	183.0 7.20	4.2 0.16	1.4 0.06	383.7	70.1	0.1220	5.65 12.45

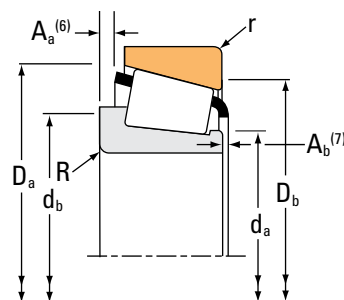
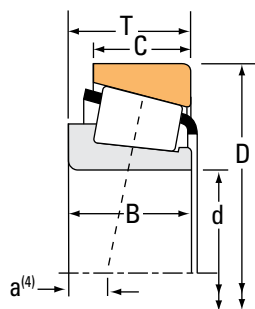
⁽⁴⁾Negative value indicates effective center inside cone (inner-ring) backface.
⁽⁵⁾These maximum fillet radii will be cleared by the bearing corners.
⁽⁶⁾Negative value indicates cage extends beyond cone (inner-ring) backface.
⁽⁷⁾Negative value indicates cage that does not extend beyond cone (inner-ring) front face.

Continued on next page.

TAPERED ROLLER BEARINGS

SINGLE-ROW • TYPE TS

TYPE TS



Bearing Dimensions			Load Ratings							Part Number		
Bore d	O.D. D	Width T	Dynamic ⁽¹⁾		Factors ⁽²⁾		Dynamic ⁽³⁾		Factors ⁽²⁾	Static	Inner	Outer
			C ₁	e	Y	C ₉₀	C _{a90}	K	C ₀			
mm in.	mm in.	mm in.	N lbf			N lbf	N lbf		N lbf			
127.000 5.0000	215.900 8.5000	47.625 1.8750	382000 85900	0.49	1.23	99000 22300	82600 18600	1.20	614000 138000		74500	74850
127.000 5.0000	228.600 9.0000	53.975 2.1250	446000 100000	0.74	0.81	116000 26000	146000 32700	0.79	486000 109000		97500	97900
127.000 5.0000	228.600 9.0000	53.975 2.1250	586000 132000	0.74	0.81	152000 34200	192000 43100	0.79	673000 151000		HM926747	HM926710
127.000 5.0000	234.950 9.2500	63.500 2.5000	629000 141000	0.37	1.62	163000 36700	103000 23200	1.58	931000 209000		95500	95925
127.000 5.0000	244.475 9.6250	63.500 2.5000	629000 141000	0.37	1.62	163000 36700	103000 23200	1.58	931000 209000		95500	95962
127.000 5.0000	250.825 9.8750	63.500 2.5000	602000 135000	0.37	1.63	156000 35100	98100 22100	1.59	867000 195000		EE116050	116098
127.000 5.0000	254.000 10.0000	66.675 2.6250	660000 148000	0.41	1.47	171000 38500	119000 26800	1.43	1030000 231000		99500	99100
127.000 5.0000	254.000 10.0000	77.788 3.0625	910000 205000	0.32	1.87	236000 53000	130000 29200	1.82	1240000 279000		HH228349	HH228310
127.000 5.0000	288.925 11.3750	82.550 3.2500	1140000 257000	0.32	1.88	296000 66600	162000 36300	1.83	1340000 302000		HH231637	HH231610
127.000 5.0000	295.275 11.6250	82.550 3.2500	1140000 257000	0.32	1.88	296000 66600	162000 36300	1.83	1340000 302000		HH231637	HH231615
127.000 5.0000	304.800 12.0000	88.900 3.5000	1160000 260000	0.73	0.82	300000 67500	374000 84100	0.80	1250000 282000		HH932132	HH932110
127.000 5.0000	311.150 12.2500	88.900 3.5000	1160000 260000	0.73	0.82	300000 67500	374000 84100	0.80	1250000 282000		HH932132	HH932115
127.792 5.0312	228.600 9.0000	53.975 2.1250	586000 132000	0.74	0.81	152000 34200	192000 43100	0.79	673000 151000		HM926749	HM926710
128.588 5.0625	190.500 7.5000	34.925 1.3750	177000 39800	0.65	0.92	45900 10300	51300 11500	0.89	300000 67400		48506	48750
128.588 5.0625	206.375 8.1250	47.625 1.8750	378000 85000	0.46	1.31	98000 22000	77000 17300	1.27	593000 133000		799	792
129.975 5.1171	234.975 9.2510	64.798 2.5511	629000 141000	0.37	1.62	163000 36700	103000 23200	1.58	931000 209000		95512	95929
130.000 5.1181	185.000 7.2835	29.000 1.1417	196000 44000	0.47	1.27	50800 11400	41100 9250	1.24	283000 63600		JP13049A	JP13010

⁽¹⁾Based on 1 x 10⁶ revolutions L₁₀ life, for the ISO life-calculation method.

⁽²⁾Consult your Timken engineer for instructions on use or review the Timken Engineering Manual on timken.com/catalogs.

⁽³⁾Based on 90 x 10⁶ revolutions L₁₀ life, for The Timken Company life-calculation method. C₉₀ and C_{a90} are radial and thrust values.

Bearing Dimensions											Geometry Factors			Bearing Weight
Width B	Width C	Eff. Ctr. a ⁽⁴⁾	Shaft			Housing			Cage		G ₁	G ₂	C _g	
			Max Shaft Fillet Radius R ⁽⁵⁾	Backing Shoulder Dia. d _a	Backing Shoulder Dia. d _b	Max Housing Fillet Radius r ⁽⁵⁾	Backing Shoulder Dia. D _a	Backing Shoulder Dia. D _b	A _a ⁽⁶⁾	A _b ⁽⁷⁾				
mm in.	mm in.	mm in.	mm in.	mm in.	mm in.	mm in.	mm in.	mm in.	mm in.	mm in.				kg lbs.
47.625 1.8750	34.925 1.3750	2.3 0.09	3.5 0.14	141.0 5.55	148.0 5.83	3.3 0.13	208.0 8.19	196.0 7.72	4.8 0.18	2.0 0.08	362.9	68.5	0.1338	6.96 15.35
49.428 1.9460	38.100 1.5000	13.2 0.52	3.5 0.14	144.0 5.65	151.0 5.94	3.3 0.13	213.0 8.38	197.0 7.76	8.2 0.32	4.8 0.19	237.1	44.6	0.1311	8.27 18.22
49.428 1.9460	38.100 1.5000	13.5 0.53	3.5 0.14	143.0 5.63	156.0 6.14	3.3 0.13	219.3 8.63	200.0 7.87	9.0 0.35	6.4 0.26	295.4	39.0	0.1416	8.60 18.98
63.500 2.5000	49.212 1.9375	-14.0 -0.55	6.4 0.25	142.0 5.59	154.0 6.06	3.3 0.13	217.0 8.54	209.0 8.23	6.4 0.25	3.8 0.15	453.9	59.4	0.1323	11.74 25.89
63.500 2.5000	49.212 1.9375	-14.0 -0.55	6.4 0.25	142.0 5.59	154.0 6.06	3.3 0.13	217.0 8.54	213.0 8.39	6.4 0.25	3.8 0.15	453.9	59.4	0.1323	13.10 28.87
63.500 2.5000	47.625 1.8750	-13.5 -0.53	3.3 0.13	144.0 5.67	148.0 5.83	4.8 0.19	224.0 8.82	220.0 8.66	8.5 0.33	1.6 0.07	416.6	57.3	0.1279	13.60 30.00
66.675 2.6250	47.625 1.8750	-12.2 -0.48	6.4 0.25	149.0 5.87	159.0 6.26	3.3 0.13	238.0 9.37	227.0 8.94	9.7 0.38	3.6 0.14	555.5	73.5	0.1459	15.46 34.07
82.550 3.2500	61.912 2.4375	-23.4 -0.92	9.7 0.38	148.0 5.83	164.0 6.46	6.4 0.25	233.6 9.20	223.0 8.78	7.0 0.27	0.0 0.00	529.8	44.8	0.1329	17.87 39.38
87.312 3.4375	57.150 2.2500	-26.7 -1.05	13.5 0.53	150.0 5.91	174.0 6.85	6.4 0.25	263.7 10.38	255.0 10.04	12.6 0.49	1.1 0.05	601.3	57.7	0.1083	25.30 55.78
87.312 3.4375	57.150 2.2500	-26.7 -1.05	13.5 0.53	150.0 5.91	174.0 6.85	6.4 0.25	263.7 10.38	258.0 10.16	12.6 0.49	1.1 0.05	601.3	57.7	0.1083	26.60 58.65
82.550 3.2500	57.150 2.2500	1.8 0.07	6.4 0.25	172.0 6.77	182.0 7.17	6.4 0.25	288.0 11.34	260.0 10.24	21.4 0.84	8.9 0.35	514.3	55.6	0.1333	29.56 65.16
82.550 3.2500	57.150 2.2500	1.8 0.07	6.4 0.25	172.0 6.77	182.0 7.17	6.4 0.25	288.0 11.34	262.0 10.31	21.4 0.84	8.9 0.35	514.3	55.6	0.1333	30.82 67.94
49.428 1.9460	38.100 1.5000	13.5 0.53	3.5 0.14	143.0 5.63	156.0 6.14	3.3 0.13	219.3 8.63	200.0 7.87	9.0 0.35	6.4 0.26	295.4	39.0	0.1416	8.54 18.84
31.750 1.2500	25.400 1.0000	16.5 0.65	3.5 0.14	138.0 5.43	144.0 5.67	3.3 0.13	183.0 7.20	170.0 6.69	4.4 0.17	0.9 0.04	218.2	71.4	0.1783	3.07 6.76
47.625 1.8750	34.925 1.3750	-1.8 -0.07	3.3 0.13	140.0 5.51	146.0 5.75	3.3 0.13	196.0 7.72	186.0 7.32	5.3 0.21	2.8 0.11	326.4	62.0	0.1269	5.76 12.71
63.500 2.5000	49.950 1.9665	-14.0 -0.55	6.4 0.25	145.0 5.71	157.0 6.18	3.3 0.13	217.0 8.54	208.0 8.19	6.4 0.25	3.8 0.15	453.9	59.4	0.1323	11.54 25.45
27.000 1.0630	21.000 0.8268	8.9 0.35	6.0 0.24	137.0 5.39	149.0 5.87	3.0 0.12	179.0 7.05	172.0 6.77	2.3 0.09	4.1 0.17	192.2	60.3	0.1064	2.15 4.73

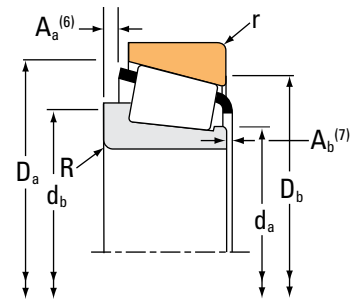
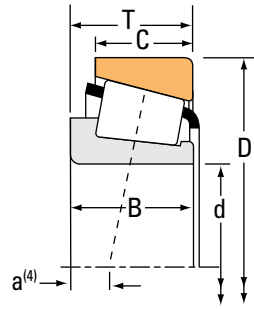
(4) Negative value indicates effective center inside cone (inner-ring) backface.
 (5) These maximum fillet radii will be cleared by the bearing corners.
 (6) Negative value indicates cage extends beyond cone (inner-ring) backface.
 (7) Negative value indicates cage that does not extend beyond cone (inner-ring) front face.

Continued on next page.

TAPERED ROLLER BEARINGS

SINGLE-ROW • TYPE TS

TYPE TS



Bearing Dimensions			Load Ratings							Part Number			
Bore d	O.D. D	Width T	Dynamic ⁽¹⁾		Factors ⁽²⁾		Dynamic ⁽³⁾		Factors ⁽²⁾		Static C ₀	Inner	Outer
			C ₁	e	Y	C ₉₀	C _{a90}	K	N	N			
mm in.	mm in.	mm in.	N lbf			N lbf	N lbf		N lbf				
130.000 5.1181	185.000 7.2835	29.000 1.1417	196000 44000	0.47	1.27	50800 11400	41100 9250	1.24	283000 63600			JP13049	JP13010
130.000 5.1181	206.375 8.1250	47.625 1.8750	378000 85000	0.46	1.31	98000 22000	77000 17300	1.27	593000 133000			797	792
130.000 5.1181	230.000 9.0551	63.500 2.5000	629000 141000	0.37	1.62	163000 36700	103000 23200	1.58	931000 209000			95512X	95905
130.000 5.1181	234.950 9.2500	63.500 2.5000	629000 141000	0.37	1.62	163000 36700	103000 23200	1.58	931000 209000			95512X	95925
130.000 5.1181	234.975 9.2510	63.500 2.5000	629000 141000	0.37	1.62	163000 36700	103000 23200	1.58	931000 209000			95512X	95928
130.175 5.1250	196.850 7.7500	46.038 1.8125	368000 82600	0.34	1.74	95300 21400	56100 12600	1.70	625000 141000			67389	67322
130.175 5.1250	203.200 8.0000	46.038 1.8125	368000 82600	0.34	1.74	95300 21400	56100 12600	1.70	625000 141000			67389	67320
130.175 5.1250	206.375 8.1250	47.625 1.8750	378000 85000	0.46	1.31	98000 22000	77000 17300	1.27	593000 133000			799A	792
133.350 5.2500	173.038 6.8125	19.050 0.7500	96400 21700	0.35	1.72	25000 5620	14900 3350	1.68	170000 38300			LL327049	LL327010
133.350 5.2500	177.008 6.9688	25.400 1.0000	147000 33100	0.35	1.72	38100 8570	22700 5110	1.68	289000 65000			L327249	L327210
133.350 5.2500	190.500 7.5000	39.688 1.5625	283000 63600	0.32	1.87	73300 16500	40300 9060	1.82	542000 122000			48385	48320
133.350 5.2500	196.850 7.7500	46.038 1.8125	368000 82600	0.34	1.74	95300 21400	56100 12600	1.70	625000 141000			67390	67322
133.350 5.2500	196.850 7.7500	46.038 1.8125	368000 82600	0.34	1.74	95300 21400	56100 12600	1.70	625000 141000			67391	67322
133.350 5.2500	203.200 8.0000	46.038 1.8125	368000 82600	0.34	1.74	95300 21400	56100 12600	1.70	625000 141000			67390	67320
133.350 5.2500	203.200 8.0000	46.038 1.8125	368000 82600	0.34	1.74	95300 21400	56100 12600	1.70	625000 141000			67391	67320
133.350 5.2500	214.975 8.4636	47.625 1.8750	382000 85900	0.49	1.23	99000 22300	82600 18600	1.20	614000 138000			74525	74845
133.350 5.2500	215.900 8.5000	47.625 1.8750	382000 85900	0.49	1.23	99000 22300	82600 18600	1.20	614000 138000			74525	74850

⁽¹⁾Based on 1 x 10⁶ revolutions L₁₀ life, for the ISO life-calculation method.

⁽²⁾Consult your Timken engineer for instructions on use or review the Timken Engineering Manual on timken.com/catalogs.

⁽³⁾Based on 90 x 10⁶ revolutions L₁₀ life, for The Timken Company life-calculation method. C₉₀ and C_{a90} are radial and thrust values.

Bearing Dimensions											Geometry Factors			Bearing Weight
Width B	Width C	Eff. Ctr. a ⁽⁴⁾	Shaft			Housing			Cage		G ₁	G ₂	C _g	
			Max Shaft Fillet Radius R ⁽⁵⁾	Backing Shoulder Dia. d _a	Backing Shoulder Dia. d _b	Max Housing Fillet Radius r ⁽⁵⁾	Backing Shoulder Dia. D _a	Backing Shoulder Dia. D _b	A _a ⁽⁶⁾	A _b ⁽⁷⁾				
mm in.	mm in.	mm in.	mm in.	mm in.	mm in.	mm in.	mm in.	mm in.	mm in.	mm in.				kg lbs.
27.000 1.0630	21.000 0.8268	8.9 0.35	3.0 0.12	137.0 5.39	143.0 5.63	3.0 0.12	179.0 7.05	172.0 6.77	2.3 0.09	4.1 0.17	192.2	60.3	0.1064	2.16 4.76
47.625 1.8750	34.925 1.3750	-1.8 -0.07	3.5 0.14	141.0 5.55	148.0 5.83	3.3 0.13	196.0 7.72	186.0 7.32	5.3 0.21	2.8 0.11	326.4	62.0	0.1269	5.65 12.47
63.500 2.5000	49.212 1.9375	-14.0 -0.55	6.0 0.24	145.0 5.71	156.0 6.14	3.3 0.13	217.0 8.54	207.0 8.15	6.4 0.25	3.8 0.15	453.9	59.4	0.1323	10.75 23.70
63.500 2.5000	49.212 1.9375	-14.0 -0.55	6.0 0.24	145.0 5.71	156.0 6.14	3.3 0.13	217.0 8.54	209.0 8.23	6.4 0.25	3.8 0.15	453.9	59.4	0.1323	11.44 25.24
63.500 2.5000	49.212 1.9375	-14.0 -0.55	6.0 0.24	145.0 5.71	156.0 6.14	3.3 0.13	217.0 8.54	209.0 8.23	6.4 0.25	3.8 0.15	453.9	59.4	0.1323	11.42 25.18
46.038 1.8125	38.100 1.5000	-6.4 -0.25	3.5 0.14	141.0 5.55	147.0 5.79	3.3 0.13	189.0 7.44	180.0 7.09	4.2 0.16	1.4 0.06	383.7	70.1	0.1220	4.82 10.63
46.038 1.8125	38.100 1.5000	-6.4 -0.25	3.5 0.14	141.0 5.55	147.0 5.79	3.3 0.13	191.0 7.52	183.0 7.20	4.2 0.16	1.4 0.06	383.7	70.1	0.1220	5.42 11.94
47.625 1.8750	34.925 1.3750	-1.8 -0.07	3.5 0.14	142.0 5.59	148.0 5.83	3.3 0.13	196.0 7.72	186.0 7.32	5.3 0.21	2.8 0.11	326.4	62.0	0.1269	5.64 12.44
17.462 0.6875	14.288 0.5625	7.6 0.30	1.5 0.06	139.0 5.47	141.0 5.55	1.5 0.06	167.0 6.57	164.0 6.46	1.4 0.05	2.0 0.08	187.7	146.2	0.1377	1.00 2.21
26.195 1.0313	20.638 0.8125	4.1 0.16	1.5 0.06	140.0 5.51	142.0 5.59	1.5 0.06	171.0 6.73	167.0 6.57	0.7 0.03	1.7 0.07	280.1	155.8	0.1585	1.72 3.78
39.688 1.5625	33.338 1.3125	-4.1 -0.16	3.5 0.14	142.0 5.59	148.0 5.83	3.3 0.13	184.0 7.24	177.0 6.97	2.8 0.11	1.2 0.05	403.8	105.1	0.1209	3.58 7.89
46.038 1.8125	38.100 1.5000	-6.4 -0.25	3.5 0.14	144.0 5.67	150.0 5.91	3.3 0.13	189.0 7.44	180.0 7.09	4.2 0.16	1.4 0.06	383.7	70.1	0.1220	4.58 10.10
46.038 1.8125	38.100 1.5000	-6.4 -0.25	8.0 0.31	143.0 5.63	157.0 6.18	3.3 0.13	189.0 7.44	180.0 7.09	4.2 0.16	1.4 0.06	383.7	70.1	0.1220	4.55 10.02
46.038 1.8125	38.100 1.5000	-6.4 -0.25	3.5 0.14	144.0 5.67	150.0 5.91	3.3 0.13	191.0 7.52	183.0 7.20	4.2 0.16	1.4 0.06	383.7	70.1	0.1220	5.18 11.42
46.038 1.8125	38.100 1.5000	-6.4 -0.25	8.0 0.31	143.0 5.63	157.0 6.18	3.3 0.13	191.0 7.52	183.0 7.20	4.2 0.16	1.4 0.06	383.7	70.1	0.1220	5.15 11.34
47.625 1.8750	34.925 1.3750	2.3 0.09	3.5 0.14	146.0 5.75	152.0 5.98	3.3 0.13	208.0 8.19	196.0 7.72	4.8 0.18	2.0 0.08	362.9	68.5	0.1338	6.37 14.05
47.625 1.8750	34.925 1.3750	2.3 0.09	3.5 0.14	146.0 5.75	152.0 5.98	3.3 0.13	208.0 8.19	196.0 7.72	4.8 0.18	2.0 0.08	362.9	68.5	0.1338	6.48 14.28

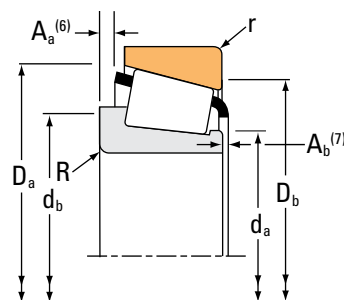
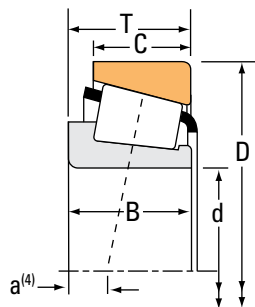
(4) Negative value indicates effective center inside cone (inner-ring) backface.
 (5) These maximum fillet radii will be cleared by the bearing corners.
 (6) Negative value indicates cage extends beyond cone (inner-ring) backface.
 (7) Negative value indicates cage that does not extend beyond cone (inner-ring) front face.

Continued on next page.

TAPERED ROLLER BEARINGS

SINGLE-ROW • TYPE TS

TYPE TS



Bearing Dimensions			Load Ratings							Part Number		
Bore d	O.D. D	Width T	Dynamic ⁽¹⁾		Factors ⁽²⁾		Dynamic ⁽³⁾		Factors ⁽²⁾	Static	Inner	Outer
			C ₁	e	Y	C ₉₀	C _{a90}	K	C ₀			
mm in.	mm in.	mm in.	N lbf			N lbf	N lbf			N lbf		
133.350 5.2500	215.900 8.5000	53.975 2.1250	382000 85900	0.49	1.23	99000 22300	82600 18600	1.20		614000 138000	74525	74853
133.350 5.2500	234.950 9.2500	63.500 2.5000	629000 141000	0.37	1.62	163000 36700	103000 23200	1.58		931000 209000	95525	95925
133.350 5.2500	234.950 9.2500	63.500 2.5000	629000 141000	0.37	1.62	163000 36700	103000 23200	1.58		931000 209000	95528	95925
136.525 5.3750	190.500 7.5000	39.688 1.5625	283000 63600	0.32	1.87	73300 16500	40300 9060	1.82		542000 122000	48393	48320
136.525 5.3750	203.200 8.0000	39.688 1.5625	283000 63600	0.32	1.87	73300 16500	40300 9060	1.82		542000 122000	48393	48328
136.525 5.3750	215.900 8.5000	47.625 1.8750	382000 85900	0.49	1.23	99000 22300	82600 18600	1.20		614000 138000	74537	74850
136.525 5.3750	217.488 8.5625	47.625 1.8750	382000 85900	0.49	1.23	99000 22300	82600 18600	1.20		614000 138000	74537	74856
136.525 5.3750	228.600 9.0000	57.150 2.2500	520000 117000	0.42	1.43	135000 30300	97200 21800	1.39		809000 182000	896	892
139.700 5.5000	187.325 7.3750	28.575 1.1250	227000 51000	0.36	1.69	58800 13200	35700 8030	1.65		375000 84300	LM328448	LM328410
139.700 5.5000	214.975 8.4636	47.625 1.8750	382000 85900	0.49	1.23	99000 22300	82600 18600	1.20		614000 138000	74550	74845
139.700 5.5000	215.900 8.5000	47.625 1.8750	382000 85900	0.49	1.23	99000 22300	82600 18600	1.20		614000 138000	74550	74850
139.700 5.5000	215.900 8.5000	47.625 1.8750	382000 85900	0.49	1.23	99000 22300	82600 18600	1.20		614000 138000	74550A	74850
139.700 5.5000	222.250 8.7500	34.925 1.3750	293000 65800	0.44	1.37	75900 17100	56800 12800	1.34		342000 77000	73551	73875
139.700 5.5000	228.600 9.0000	57.150 2.2500	520000 117000	0.42	1.43	135000 30300	97200 21800	1.39		809000 182000	898	892
139.700 5.5000	228.600 9.0000	57.150 2.2500	520000 117000	0.42	1.43	135000 30300	97200 21800	1.39		809000 182000	898A	892
139.700 5.5000	236.538 9.3125	57.150 2.2500	597000 134000	0.32	1.88	155000 34800	84500 19000	1.83		932000 210000	HM231132	HM231110
139.700 5.5000	241.300 9.5000	57.150 2.2500	597000 134000	0.32	1.88	155000 34800	84500 19000	1.83		932000 210000	HM231132	HM231115

⁽¹⁾Based on 1 x 10⁶ revolutions L₁₀ life, for the ISO life-calculation method.

⁽²⁾Consult your Timken engineer for instructions on use or review the Timken Engineering Manual on timken.com/catalogs.

⁽³⁾Based on 90 x 10⁶ revolutions L₁₀ life, for The Timken Company life-calculation method. C₉₀ and C_{a90} are radial and thrust values.

Bearing Dimensions											Geometry Factors			Bearing Weight
Width B	Width C	Eff. Ctr. a ⁽⁴⁾	Shaft			Housing			Cage		G ₁	G ₂	C _g	
			Max Shaft Fillet Radius R ⁽⁵⁾	Backing Shoulder Dia. d _a	Backing Shoulder Dia. d _b	Max Housing Fillet Radius r ⁽⁵⁾	Backing Shoulder Dia. D _a	Backing Shoulder Dia. D _b	A _a ⁽⁶⁾	A _b ⁽⁷⁾				
mm in.	mm in.	mm in.	mm in.	mm in.	mm in.	mm in.	mm in.	mm in.	mm in.	mm in.				kg lbs.
47.625 1.8750	47.625 1.8750	2.3 0.09	3.5 0.14	146.0 5.75	152.0 5.98	3.3 0.13	209.0 8.23	196.0 7.72	4.8 0.18	2.0 0.08	362.9	68.5	0.1338	7.15 15.77
63.500 2.5000	49.212 1.9375	-14.0 -0.55	9.7 0.38	148.0 5.83	166.0 6.54	3.3 0.13	217.0 8.54	209.0 8.23	6.4 0.25	3.8 0.15	453.9	59.4	0.1323	11.00 24.26
63.500 2.5000	49.212 1.9375	-14.0 -0.55	4.8 0.19	148.0 5.83	157.0 6.18	3.3 0.13	217.0 8.54	209.0 8.23	6.4 0.25	3.8 0.15	453.9	59.4	0.1323	11.12 24.53
39.688 1.5625	33.338 1.3125	-4.1 -0.16	3.5 0.14	144.0 5.67	151.0 5.94	3.3 0.13	184.0 7.24	177.0 6.97	2.8 0.11	1.2 0.05	403.8	105.1	0.1209	3.38 7.45
39.688 1.5625	33.338 1.3125	-4.1 -0.16	3.5 0.14	144.0 5.67	151.0 5.94	3.3 0.13	186.0 7.32	182.0 7.17	2.8 0.11	1.2 0.05	403.8	105.1	0.1209	4.39 9.67
47.625 1.8750	34.925 1.3750	2.3 0.09	3.5 0.14	148.0 5.83	155.0 6.10	3.3 0.13	208.0 8.19	196.0 7.72	4.8 0.18	2.0 0.08	362.9	68.5	0.1338	6.23 13.72
47.625 1.8750	34.925 1.3750	2.3 0.09	3.5 0.14	148.0 5.83	155.0 6.10	3.3 0.13	209.0 8.23	197.0 7.76	4.8 0.18	2.0 0.08	362.9	68.5	0.1338	6.35 14.01
57.150 2.2500	44.450 1.7500	-6.1 -0.24	3.5 0.14	150.0 5.91	156.0 6.14	3.3 0.13	216.0 8.50	205.0 8.07	6.4 0.25	1.4 0.06	430.5	78.3	0.1355	9.00 19.84
29.370 1.1563	23.020 0.9063	3.6 0.14	1.5 0.06	147.0 5.79	149.0 5.87	1.5 0.06	182.0 7.17	176.0 6.93	1.1 0.04	1.9 0.08	336.5	179.4	0.1700	2.21 4.85
47.625 1.8750	34.925 1.3750	2.3 0.09	3.5 0.14	151.0 5.94	158.0 6.22	3.3 0.13	208.0 8.19	196.0 7.72	4.8 0.18	2.0 0.08	362.9	68.5	0.1338	5.86 12.93
47.625 1.8750	34.925 1.3750	2.3 0.09	3.5 0.14	151.0 5.94	158.0 6.22	3.3 0.13	208.0 8.19	196.0 7.72	4.8 0.18	2.0 0.08	362.9	68.5	0.1338	5.97 13.16
47.625 1.8750	34.925 1.3750	2.3 0.09	6.4 0.25	154.0 6.06	166.0 6.54	3.3 0.13	208.0 8.19	196.0 7.72	4.8 0.18	2.0 0.08	362.9	68.5	0.1338	5.96 13.13
31.623 1.2450	23.812 0.9375	6.4 0.25	3.5 0.14	150.0 5.91	156.0 6.14	3.3 0.13	207.0 8.15	204.0 8.03	5.7 0.22	4.0 0.16	244.4	82.0	0.1122	4.29 9.44
57.150 2.2500	44.450 1.7500	-6.1 -0.24	3.5 0.14	153.0 6.02	160.0 6.30	3.3 0.13	216.0 8.50	205.0 8.07	6.4 0.25	1.4 0.06	430.5	78.3	0.1355	8.69 19.16
57.150 2.2500	44.450 1.7500	-6.1 -0.24	6.4 0.25	153.0 6.02	165.0 6.50	3.3 0.13	216.0 8.50	205.0 8.07	6.4 0.25	1.4 0.06	430.5	78.3	0.1355	8.64 19.05
56.642 2.2300	44.450 1.7500	-11.4 -0.45	3.5 0.14	156.0 6.14	160.0 6.30	3.3 0.13	224.0 8.82	217.0 8.54	4.2 0.16	3.7 0.15	532.8	85.9	0.1327	9.93 21.87
56.642 2.2300	44.450 1.7500	-11.4 -0.45	3.5 0.14	156.0 6.14	160.0 6.30	3.3 0.13	224.0 8.82	219.0 8.62	4.2 0.16	3.7 0.15	532.8	85.9	0.1327	10.55 23.24

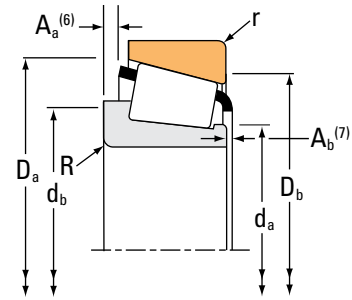
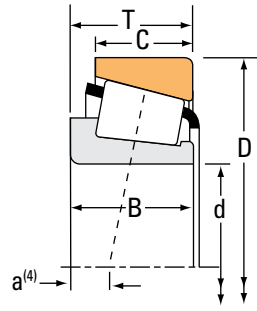
(4) Negative value indicates effective center inside cone (inner-ring) backface.
 (5) These maximum fillet radii will be cleared by the bearing corners.
 (6) Negative value indicates cage extends beyond cone (inner-ring) backface.
 (7) Negative value indicates cage that does not extend beyond cone (inner-ring) front face.

Continued on next page.

TAPERED ROLLER BEARINGS

SINGLE-ROW • TYPE TS

TYPE TS



Bearing Dimensions			Load Ratings							Part Number		
Bore d	O.D. D	Width T	Dynamic ⁽¹⁾		Factors ⁽²⁾		Dynamic ⁽³⁾		Factors ⁽²⁾	Static	Inner	Outer
			C ₁	e	Y	C ₉₀	C _{a90}	K	C ₀			
mm in.	mm in.	mm in.	N lbf			N lbf	N lbf			N lbf		
139.700 5.5000	254.000 10.0000	66.675 2.6250	660000 148000	0.41	1.47	171000 38500	119000 26800	1.43		1030000 231000	99550	99100
139.700 5.5000	288.925 11.3750	82.550 3.2500	1140000 257000	0.32	1.88	296000 66600	162000 36300	1.83		1340000 302000	HH231649	HH231610
139.700 5.5000	295.275 11.6250	82.550 3.2500	1140000 257000	0.32	1.88	296000 66600	162000 36300	1.83		1340000 302000	HH231649	HH231615
139.700 5.5000	307.975 12.1250	88.900 3.5000	1150000 259000	0.33	1.84	299000 67200	167000 37500	1.79		1580000 354000	HH234032	HH234010
139.700 5.5000	307.975 12.1250	88.900 3.5000	1150000 259000	0.33	1.84	299000 67200	167000 37500	1.79		1580000 354000	HH234031	HH234010
140.000 5.5118	195.000 7.6772	29.000 1.1417	203000 45700	0.50	1.19	52700 11800	45400 10200	1.16		304000 68400	JP14049	JP14010
142.875 5.6250	193.675 7.6250	28.575 1.1250	196000 44200	0.37	1.63	50900 11400	32100 7220	1.59		394000 88600	36686	36620
142.875 5.6250	200.025 7.8750	41.275 1.6250	286000 64400	0.34	1.78	74300 16700	42800 9610	1.74		560000 126000	48684	48620
142.875 5.6250	200.025 7.8750	41.275 1.6250	286000 64400	0.34	1.78	74300 16700	42800 9610	1.74		560000 126000	48685	48620
142.875 5.6250	222.250 8.7500	34.925 1.3750	293000 65800	0.44	1.37	75900 17100	56800 12800	1.34		342000 77000	73562	73875
142.875 5.6250	236.538 9.3125	57.150 2.2500	515000 116000	0.44	1.36	134000 30000	101000 22700	1.32		810000 182000	82562A	82931
142.875 5.6250	241.300 9.5000	57.150 2.2500	597000 134000	0.32	1.88	155000 34800	84500 19000	1.83		932000 210000	HM231136	HM231115
142.875 5.6250	241.300 9.5000	57.150 2.2500	515000 116000	0.44	1.36	134000 30000	101000 22700	1.32		810000 182000	82562A	82950
146.050 5.7500	188.120 7.4063	22.225 0.8750	113000 25400	0.38	1.57	29300 6590	19200 4310	1.53		214000 48200	LL529749	LL529710
146.050 5.7500	193.675 7.6250	28.575 1.1250	196000 44200	0.37	1.63	50900 11400	32100 7220	1.59		394000 88600	36690	36620
146.050 5.7500	193.675 7.6250	28.575 1.1250	196000 44200	0.37	1.63	50900 11400	32100 7220	1.59		394000 88600	36691	36620
146.050 5.7500	203.200 8.0000	28.575 1.1250	196000 44200	0.37	1.63	50900 11400	32100 7220	1.59		394000 88600	36690	36626

⁽¹⁾Based on 1 x 10⁶ revolutions L₁₀ life, for the ISO life-calculation method.

⁽²⁾Consult your Timken engineer for instructions on use or review the Timken Engineering Manual on timken.com/catalogs.

⁽³⁾Based on 90 x 10⁶ revolutions L₁₀ life, for The Timken Company life-calculation method. C₉₀ and C_{a90} are radial and thrust values.

Bearing Dimensions											Geometry Factors			Bearing Weight
Width B	Width C	Eff. Ctr. a ⁽⁴⁾	Shaft			Housing			Cage		G ₁	G ₂	C _g	
			Max Shaft Fillet Radius R ⁽⁵⁾	Backing Shoulder Dia. d _a	Shoulder Dia. d _b	Max Housing Fillet Radius r ⁽⁵⁾	Backing Shoulder Dia. D _a	Shoulder Dia. D _b	A _a ⁽⁶⁾	A _b ⁽⁷⁾				
mm in.	mm in.	mm in.	mm in.	mm in.	mm in.	mm in.	mm in.	mm in.	mm in.	mm in.				kg lbs.
66.675 2.6250	47.625 1.8750	-12.2 -0.48	7.0 0.28	156.0 6.14	170.0 6.69	3.3 0.13	238.0 9.37	227.0 8.94	9.7 0.38	3.6 0.14	555.5	73.5	0.1459	14.02 30.90
87.312 3.4375	57.150 2.2500	-26.7 -1.05	9.7 0.38	161.0 6.34	177.0 6.97	6.4 0.25	263.7 10.38	255.0 10.04	12.6 0.49	1.1 0.05	601.3	57.7	0.1083	23.73 52.31
87.312 3.4375	57.150 2.2500	-26.7 -1.05	9.7 0.38	161.0 6.34	177.0 6.97	6.4 0.25	263.7 10.38	258.0 10.16	12.6 0.49	1.1 0.05	601.3	57.7	0.1083	25.03 55.18
93.662 3.6875	66.675 2.6250	-26.4 -1.04	9.7 0.38	167.9 6.61	180.0 7.09	6.8 0.27	285.5 11.24	276.1 10.87	10.5 0.41	1.1 0.05	718.4	62.1	0.1157	31.27 68.92
93.662 3.6875	66.675 2.6250	-26.4 -1.04	9.7 0.38	167.9 6.61	180.0 7.09	6.8 0.27	285.5 11.24	276.1 10.87	12.5 0.49	-0.8 -0.03	718.4	62.1	0.1157	31.13 68.61
27.000 1.0630	21.000 0.8268	11.9 0.47	3.0 0.12	148.0 5.83	153.0 6.02	3.0 0.12	189.0 7.44	182.0 7.17	2.6 0.10	4.2 0.17	219.5	68.2	0.1133	2.29 5.06
28.575 1.1250	23.020 0.9063	4.8 0.19	1.5 0.06	151.0 5.94	153.0 6.02	1.5 0.06	188.0 7.40	182.0 7.17	1.2 0.04	2.7 0.11	366.1	152.5	0.1768	2.41 5.31
39.688 1.5625	34.130 1.3437	-3.0 -0.12	8.0 0.31	151.0 5.94	166.0 6.54	3.3 0.13	193.0 7.60	185.0 7.28	2.8 0.11	2.5 0.10	439.6	130.5	0.1261	3.75 8.25
39.688 1.5625	34.130 1.3437	-3.0 -0.12	3.5 0.14	151.0 5.94	158.0 6.22	3.3 0.13	193.0 7.60	185.0 7.28	2.8 0.11	2.5 0.10	439.6	130.5	0.1261	3.86 8.50
31.623 1.2450	23.812 0.9375	6.4 0.25	3.5 0.14	152.0 5.98	159.0 6.26	3.3 0.13	207.0 8.15	204.0 8.03	5.7 0.22	4.0 0.16	244.4	82.0	0.1122	4.11 9.05
56.642 2.2300	44.450 1.7500	-3.6 -0.14	8.0 0.31	157.0 6.18	172.0 6.77	3.3 0.13	226.0 8.90	213.0 8.39	5.7 0.22	2.2 0.09	460.5	81.1	0.1405	9.46 20.84
56.642 2.2300	44.450 1.7500	-11.4 -0.45	3.5 0.14	158.0 6.22	162.0 6.38	3.3 0.13	224.0 8.82	219.0 8.62	4.2 0.16	3.7 0.15	532.8	85.9	0.1327	10.24 22.55
56.642 2.2300	44.450 1.7500	-3.6 -0.14	8.0 0.31	157.0 6.18	172.0 6.77	3.3 0.13	226.0 8.90	215.0 8.46	5.7 0.22	2.2 0.09	460.5	81.1	0.1405	10.08 22.21
20.638 0.8125	16.670 0.6563	9.4 0.37	1.5 0.06	152.0 5.98	155.0 6.10	1.5 0.06	182.0 7.17	179.0 7.05	0.4 0.01	1.9 0.08	248.3	185.9	0.1557	1.41 3.12
28.575 1.1250	23.020 0.9063	4.8 0.19	1.5 0.06	153.0 6.02	155.0 6.10	1.5 0.06	188.0 7.40	182.0 7.17	1.2 0.04	2.7 0.11	366.1	152.5	0.1768	2.25 4.96
28.575 1.1250	23.020 0.9063	4.8 0.19	4.8 0.19	153.0 6.02	162.0 6.38	1.5 0.06	188.0 7.40	182.0 7.17	1.2 0.04	2.7 0.11	366.1	152.5	0.1768	2.21 4.87
28.575 1.1250	23.020 0.9063	4.8 0.19	1.5 0.06	153.0 6.02	155.0 6.10	1.5 0.06	190.0 7.48	186.0 7.32	1.2 0.04	2.7 0.11	366.1	152.5	0.1768	2.78 6.14

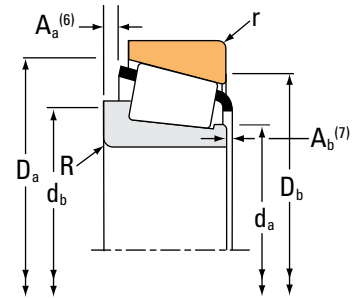
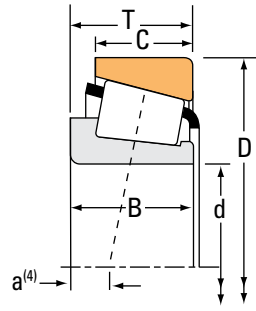
⁽⁴⁾Negative value indicates effective center inside cone (inner-ring) backface.
⁽⁵⁾These maximum fillet radii will be cleared by the bearing corners.
⁽⁶⁾Negative value indicates cage extends beyond cone (inner-ring) backface.
⁽⁷⁾Negative value indicates cage that does not extend beyond cone (inner-ring) front face.

Continued on next page.

TAPERED ROLLER BEARINGS

SINGLE-ROW • TYPE TS

TYPE TS



Bearing Dimensions			Load Ratings							Part Number		
Bore d	O.D. D	Width T	Dynamic ⁽¹⁾		Factors ⁽²⁾		Dynamic ⁽³⁾		Factors ⁽²⁾	Static	Inner	Outer
			C ₁	e	Y	C ₉₀	C _{a90}	K	C ₀			
mm in.	mm in.	mm in.	N lbf			N lbf	N lbf			N lbf		
146.050 5.7500	203.200 8.0000	45.100 1.7756	334000 75000	0.33	1.80	86500 19400	49200 11100	1.76		573000 129000	M229349	M229310
146.050 5.7500	203.200 8.0000	45.100 1.7756	334000 75000	0.33	1.80	86500 19400	49200 11100	1.76		573000 129000	M229349A	M229310
146.050 5.7500	236.538 9.3125	57.150 2.2500	515000 116000	0.44	1.36	134000 30000	101000 22700	1.32		810000 182000	82576	82931
146.050 5.7500	241.300 9.5000	57.150 2.2500	515000 116000	0.44	1.36	134000 30000	101000 22700	1.32		810000 182000	82576	82950
146.050 5.7500	241.300 9.5000	57.150 2.2500	597000 134000	0.32	1.88	155000 34800	84500 19000	1.83		932000 210000	HM231140	HM231115
146.050 5.7500	244.475 9.6250	47.625 1.8750	402000 90300	0.35	1.71	104000 23400	62700 14100	1.66		595000 134000	81575	81962
146.050 5.7500	254.000 10.0000	66.675 2.6250	660000 148000	0.41	1.47	171000 38500	119000 26800	1.43		1030000 231000	99575	99100
146.050 5.7500	268.288 10.5625	74.612 2.9375	784000 176000	0.39	1.55	203000 45700	135000 30300	1.51		1170000 263000	EE107057	107105
146.050 5.7500	304.800 12.0000	60.325 2.3750	775000 174000	0.33	1.80	201000 45200	114000 25700	1.76		871000 196000	EE750576	751200
146.050 5.7500	304.800 12.0000	88.900 3.5000	1160000 260000	0.73	0.82	300000 67500	374000 84100	0.80		1250000 282000	HH932145	HH932110
146.050 5.7500	307.975 12.1250	88.900 3.5000	1050000 237000	0.33	1.84	273000 61400	152000 34300	1.79		1480000 333000	EE450577	451212
146.050 5.7500	307.975 12.1250	88.900 3.5000	1150000 259000	0.33	1.84	299000 67200	167000 37500	1.79		1580000 354000	HH234040	HH234010
146.050 5.7500	311.150 12.2500	88.900 3.5000	1160000 260000	0.73	0.82	300000 67500	374000 84100	0.80		1250000 282000	HH932145	HH932115
149.225 5.8750	236.538 9.3125	57.150 2.2500	597000 134000	0.32	1.88	155000 34800	84500 19000	1.83		932000 210000	HM231149	HM231110
149.225 5.8750	236.538 9.3125	57.150 2.2500	597000 134000	0.32	1.88	155000 34800	84500 19000	1.83		932000 210000	HM231148	HM231110
149.225 5.8750	241.300 9.5000	57.150 2.2500	597000 134000	0.32	1.88	155000 34800	84500 19000	1.83		932000 210000	HM231149	HM231115
149.225 5.8750	254.000 10.0000	66.675 2.6750	660000 148000	0.41	1.47	171000 38500	119000 26800	1.43		1030000 231000	99587	99100

⁽¹⁾Based on 1×10^6 revolutions L_{10} life, for the ISO life-calculation method.

⁽²⁾Consult your Timken engineer for instructions on use or review the Timken Engineering Manual on timken.com/catalogs.

⁽³⁾Based on 90×10^6 revolutions L_{10} life, for The Timken Company life-calculation method. C_{90} and C_{a90} are radial and thrust values.

Bearing Dimensions											Geometry Factors			Bearing Weight
Width B	Width C	Eff. Ctr. a ⁽⁴⁾	Shaft			Housing			Cage		G ₁	G ₂	C _g	
			Max Shaft Fillet Radius R ⁽⁵⁾	Backing Shoulder Dia. d _a	Backing Shoulder Dia. d _b	Max Housing Fillet Radius r ⁽⁵⁾	Backing Shoulder Dia. D _a	Backing Shoulder Dia. D _b	A _a ⁽⁶⁾	A _b ⁽⁷⁾				
mm in.	mm in.	mm in.	mm in.	mm in.	mm in.	mm in.	mm in.	mm in.	mm in.	mm in.				kg lbs.
40.000 1.5748	38.100 1.5000	-2.5 -0.10	3.5 0.14	154.0 6.06	160.0 6.30	3.5 0.14	197.0 7.76	187.0 7.36	1.5 0.06	2.8 0.11	401.6	98.0	0.1220	4.01 8.83
40.000 1.5748	38.100 1.5000	-2.5 -0.10	5.0 0.20	154.0 6.06	164.0 6.46	3.5 0.14	197.0 7.76	187.0 7.36	1.5 0.06	2.8 0.11	401.6	98.0	0.1220	4.00 8.81
56.642 2.2300	44.450 1.7500	-3.6 -0.14	3.5 0.14	160.0 6.30	166.0 6.54	3.3 0.13	226.0 8.90	213.0 8.39	5.7 0.22	2.2 0.09	460.5	81.1	0.1405	9.22 20.32
56.642 2.2300	44.450 1.7500	-3.6 -0.14	3.5 0.14	160.0 6.30	166.0 6.54	3.3 0.13	226.0 8.90	215.0 8.46	5.7 0.22	2.2 0.09	460.5	81.1	0.1405	9.84 21.69
56.642 2.2300	44.450 1.7500	-11.4 -0.45	3.5 0.14	160.0 6.30	164.0 6.46	3.3 0.13	224.0 8.82	219.0 8.62	4.2 0.16	3.7 0.15	532.8	85.9	0.1327	9.92 21.85
50.005 1.9687	33.338 1.3125	-5.3 -0.21	3.5 0.14	161.0 6.34	166.1 6.54	3.3 0.13	229.1 9.02	225.0 8.86	8.2 0.32	0.0 0.00	413.0	98.4	0.1250	8.23 18.13
66.675 2.6250	47.625 1.8750	-12.2 -0.48	7.0 0.28	162.0 6.38	175.0 6.89	3.3 0.13	238.0 9.37	227.0 8.94	9.7 0.38	3.6 0.14	555.5	73.5	0.1459	13.28 29.25
74.612 2.9375	57.150 2.2500	-15.0 -0.59	6.4 0.25	166.0 6.54	176.0 6.93	6.4 0.25	249.4 9.82	237.0 9.33	7.7 0.30	3.0 0.12	606.1	76.3	0.1163	17.55 38.67
61.912 2.4375	41.275 1.6250	-10.7 -0.42	3.3 0.13	172.0 6.77	167.0 6.57	6.4 0.25	272.0 10.71	270.0 10.63	6.6 0.26	3.5 0.14	431.4	54.4	0.0974	18.90 41.69
82.550 3.2500	57.150 2.2500	1.8 0.07	6.4 0.25	174.0 6.87	195.0 7.68	6.4 0.25	288.0 11.34	260.0 10.24	21.4 0.84	8.9 0.35	514.3	55.6	0.1333	26.95 59.41
93.662 3.6875	61.912 2.4375	-28.2 -1.11	9.7 0.38	172.0 6.77	185.0 7.28	6.9 0.27	274.8 10.82	269.0 10.59	17.8 0.70	-2.7 -0.10	747.4	76.3	0.1176	29.38 64.75
93.662 3.6875	66.675 2.6250	-26.4 -1.04	9.7 0.38	173.0 6.81	185.9 7.32	6.8 0.27	285.5 11.24	276.1 10.87	10.5 0.41	0.8 0.04	718.4	62.1	0.1157	30.22 66.61
82.550 3.2500	57.150 2.2500	1.8 0.07	6.4 0.25	174.0 6.87	195.0 7.68	6.4 0.25	288.0 11.34	262.0 10.31	21.4 0.84	8.9 0.35	514.3	55.6	0.1333	28.21 62.19
56.642 2.2300	44.450 1.7500	-11.4 -0.45	3.5 0.14	163.0 6.42	167.0 6.57	3.3 0.13	224.0 8.82	217.0 8.54	4.2 0.16	3.7 0.15	532.8	85.9	0.1327	8.97 19.76
56.642 2.2300	44.450 1.7500	-11.4 -0.45	6.4 0.25	163.0 6.42	172.0 6.77	3.3 0.13	224.0 8.82	217.0 8.54	4.2 0.16	3.7 0.15	532.8	85.9	0.1327	8.92 19.64
56.642 2.2300	44.450 1.7500	-11.4 -0.45	3.5 0.14	163.0 6.42	167.0 6.57	3.3 0.13	224.0 8.82	219.0 8.62	4.2 0.16	3.7 0.15	532.8	85.9	0.1327	9.59 21.13
66.675 2.6250	47.625 1.8750	-12.2 -0.48	7.0 0.28	170.0 6.69	181.0 7.13	3.3 0.13	238.0 9.37	227.0 8.94	9.7 0.38	3.6 0.14	555.5	73.5	0.1459	12.94 28.51

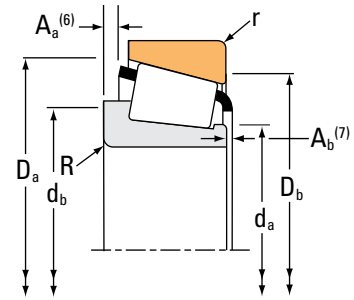
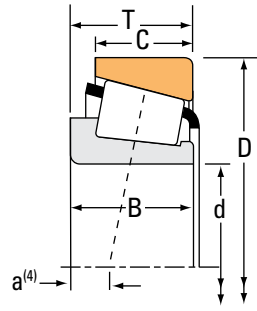
(4) Negative value indicates effective center inside cone (inner-ring) backface.
 (5) These maximum fillet radii will be cleared by the bearing corners.
 (6) Negative value indicates cage extends beyond cone (inner-ring) backface.
 (7) Negative value indicates cage that does not extend beyond cone (inner-ring) front face.

Continued on next page.

TAPERED ROLLER BEARINGS

SINGLE-ROW • TYPE TS

TYPE TS



Bearing Dimensions			Load Ratings							Part Number			
Bore d	O.D. D	Width T	Dynamic ⁽¹⁾		Factors ⁽²⁾		Dynamic ⁽³⁾		Factors ⁽²⁾		Static C ₀	Inner	Outer
			C ₁	e	Y	C ₉₀	C _{a90}	K	N	N			
mm in.	mm in.	mm in.	N lbf			N lbf	N lbf		N lbf				
150.000 5.9055	203.200 8.0000	28.575 1.1250	194000 43500	0.46	1.31	50200 11300	39400 8860	1.27	339000 76100			JL730646	L730610
150.000 5.9055	205.000 8.0709	28.575 1.1250	194000 43500	0.46	1.31	50200 11300	39400 8860	1.27	339000 76100			JL730646	JL730612
150.000 5.9055	244.475 9.6250	47.625 1.8750	402000 90300	0.35	1.71	104000 23400	62700 14100	1.66	595000 134000			81590	81962
150.000 5.9055	245.000 9.6457	47.625 1.8750	402000 90300	0.35	1.71	104000 23400	62700 14100	1.66	595000 134000			81590	81964
150.812 5.9375	244.475 9.6250	47.625 1.8750	402000 90300	0.35	1.71	104000 23400	62700 14100	1.66	595000 134000			81593	81962
152.400 6.0000	192.088 7.5625	25.000 0.9843	143000 32000	0.42	1.44	37000 8310	26300 5920	1.40	277000 62200			L630349	L630310
152.400 6.0000	203.200 8.0000	28.575 1.1250	194000 43500	0.46	1.31	50200 11300	39400 8860	1.27	339000 76100			L730649	L730610
152.400 6.0000	203.200 8.0000	41.275 1.6250	283000 63700	0.35	1.73	73400 16500	43700 9810	1.68	556000 125000			LM330448	LM330410
152.400 6.0000	244.475 9.6250	47.625 1.8750	402000 90300	0.35	1.71	104000 23400	62700 14100	1.66	595000 134000			81600	81962
152.400 6.0000	249.975 9.8415	66.675 2.6250	660000 148000	0.41	1.47	171000 38500	119000 26800	1.43	1030000 231000			99600	99097
152.400 6.0000	250.000 9.8425	66.675 2.6250	660000 148000	0.41	1.47	171000 38500	119000 26800	1.43	1030000 231000			99600	99098X
152.400 6.0000	254.000 10.0000	66.675 2.6250	660000 148000	0.41	1.47	171000 38500	119000 26800	1.43	1030000 231000			99600	99100
152.400 6.0000	268.288 10.5625	74.612 2.9375	784000 176000	0.39	1.55	203000 45700	135000 30300	1.51	1170000 263000			EE107060	107105
152.400 6.0000	285.750 11.2500	76.200 3.0000	715000 161000	0.40	1.49	185000 41700	128000 28700	1.45	1060000 237000			EE217060	217112
152.400 6.0000	307.975 12.1250	88.900 3.5000	1050000 237000	0.33	1.84	273000 61400	152000 34300	1.79	1480000 333000			EE450601	451212
152.400 6.0000	307.975 12.1250	88.900 3.5000	1220000 274000	0.33	1.84	316000 71100	177000 39700	1.79	1580000 354000			HH234049	HH234010
152.400 6.0000	307.975 12.1250	88.900 3.5000	1150000 259000	0.33	1.84	299000 67200	167000 37500	1.79	1580000 354000			HH234048	HH234010

⁽¹⁾Based on 1 x 10⁶ revolutions L₁₀ life, for the ISO life-calculation method.

⁽²⁾Consult your Timken engineer for instructions on use or review the Timken Engineering Manual on timken.com/catalogs.

⁽³⁾Based on 90 x 10⁶ revolutions L₁₀ life, for The Timken Company life-calculation method. C₉₀ and C_{a90} are radial and thrust values.

Bearing Dimensions											Geometry Factors			Bearing Weight
Width B	Width C	Eff. Ctr. a ⁽⁴⁾	Shaft			Housing			Cage		G ₁	G ₂	C _g	
			Max Shaft Fillet Radius R ⁽⁵⁾	Backing Shoulder Dia. d _a	Backing Shoulder Dia. d _b	Max Housing Fillet Radius r ⁽⁵⁾	Backing Shoulder Dia. D _a	Backing Shoulder Dia. D _b	A _a ⁽⁶⁾	A _b ⁽⁷⁾				
mm in.	mm in.	mm in.	mm in.	mm in.	mm in.	mm in.	mm in.	mm in.	mm in.	mm in.				kg lbs.
28.575 1.1250	21.438 0.8440	11.4 0.45	3.3 0.13	158.0 6.22	164.0 6.46	3.3 0.13	198.0 7.80	190.0 7.48	2.4 0.09	1.5 0.06	295.2	103.6	0.1763	2.48 5.48
28.575 1.1250	21.438 0.8440	11.4 0.45	3.3 0.13	158.0 6.22	164.0 6.46	3.3 0.13	198.0 7.80	190.0 7.48	2.4 0.09	1.5 0.06	295.2	103.6	0.1763	2.61 5.76
50.005 1.9687	33.338 1.3125	-5.3 -0.21	3.5 0.14	163.1 6.42	168.9 6.65	3.3 0.13	229.1 9.02	225.0 8.86	8.2 0.32	* *	413.0	98.4	0.1250	7.91 17.43
50.005 1.9687	33.338 1.3125	-5.3 -0.21	3.5 0.14	163.1 6.42	168.9 6.65	3.3 0.13	229.1 9.02	225.0 8.86	8.2 0.32	* *	413.0	98.4	0.1250	7.93 17.47
50.005 1.9687	33.338 1.3125	-5.3 -0.21	3.5 0.14	164.1 6.46	168.9 6.65	3.3 0.13	229.1 9.02	225.0 8.86	8.2 0.32	* *	413.0	98.4	0.1250	7.84 17.28
24.000 0.9449	19.000 0.7480	10.2 0.40	2.0 0.08	158.0 6.22	162.0 6.38	2.0 0.08	187.0 7.36	183.0 7.20	1.9 0.07	2.6 0.10	293.3	163.8	0.1698	1.56 3.44
28.575 1.1250	21.438 0.8440	11.4 0.45	3.3 0.13	160.0 6.30	165.0 6.50	3.3 0.13	198.0 7.80	190.0 7.48	2.4 0.09	1.5 0.06	295.2	103.6	0.1763	2.35 5.18
41.275 1.6250	34.925 1.3750	-1.8 -0.07	3.3 0.13	162.0 6.37	166.0 6.54	3.3 0.13	197.0 7.76	189.0 7.44	2.9 0.11	0.9 0.04	456.5	134.8	0.1289	3.53 7.79
50.005 1.9687	33.338 1.3125	-5.3 -0.21	3.5 0.14	165.0 6.50	170.9 6.73	3.3 0.13	229.1 9.02	225.0 8.86	8.2 0.32	* *	413.0	98.4	0.1250	7.68 16.91
66.675 2.6250	53.400 2.1024	-12.2 -0.48	7.0 0.28	169.7 6.68	181.0 7.13	3.0 0.12	240.0 9.45	226.0 8.90	9.7 0.38	3.6 0.14	555.5	73.5	0.1459	12.09 26.66
66.675 2.6250	47.625 1.8750	-12.2 -0.48	7.0 0.28	169.7 6.68	181.0 7.13	3.3 0.13	238.0 9.37	226.0 8.90	9.7 0.38	3.6 0.14	555.5	73.5	0.1459	11.87 26.17
66.675 2.6250	47.625 1.8750	-12.2 -0.48	7.0 0.28	169.7 6.68	181.0 7.13	3.3 0.13	238.0 9.37	227.0 8.94	9.7 0.38	3.6 0.14	555.5	73.5	0.1459	12.49 27.53
74.612 2.9375	57.150 2.2500	-15.0 -0.59	6.4 0.25	171.0 6.73	181.0 7.13	6.4 0.25	249.4 9.82	237.0 9.33	7.7 0.30	3.0 0.12	606.1	76.3	0.1163	16.68 36.75
73.025 2.8750	55.562 2.1875	-15.0 -0.59	1.5 0.06	170.9 6.73	170.9 6.73	6.4 0.25	260.4 10.25	251.0 9.88	14.9 0.58	1.7 0.07	556.3	71.8	0.1140	19.35 42.73
93.662 3.6875	61.912 2.4375	-28.2 -1.11	9.7 0.38	177.0 6.97	189.0 7.44	6.9 0.27	274.8 10.82	269.0 10.59	17.8 0.70	-2.7 -0.10	747.4	76.3	0.1176	28.40 62.59
93.662 3.6875	66.675 2.6250	-26.4 -1.04	9.7 0.38	179.1 7.05	191.0 7.52	6.8 0.27	285.5 11.24	276.1 10.87	10.5 0.41	0.8 0.04	718.4	62.1	0.1157	29.12 64.18
93.662 3.6875	66.675 2.6250	-26.4 -1.04	9.7 0.38	179.0 7.05	191.0 7.52	6.8 0.27	285.5 11.24	276.1 10.87	12.5 0.49	-0.8 -0.03	718.4	62.1	0.1157	28.98 63.88

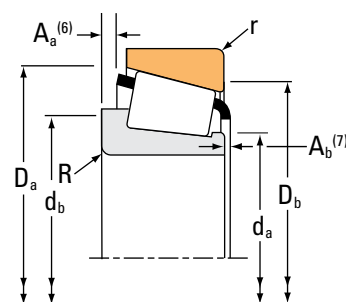
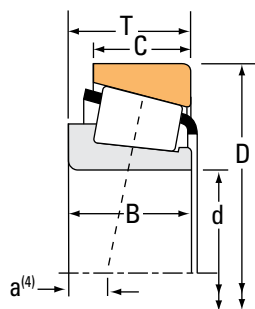
(4) Negative value indicates effective center inside cone (inner-ring) backface.
 (5) These maximum fillet radii will be cleared by the bearing corners.
 (6) Negative value indicates cage extends beyond cone (inner-ring) backface.
 (7) Negative value indicates cage that does not extend beyond cone (inner-ring) front face.
 (*) Contact your Timken engineer for details.

Continued on next page.

TAPERED ROLLER BEARINGS

SINGLE-ROW • TYPE TS

TYPE TS



Bearing Dimensions			Load Ratings							Part Number			
Bore d	O.D. D	Width T	Dynamic ⁽¹⁾		Factors ⁽²⁾		Dynamic ⁽³⁾		Factors ⁽²⁾		Static C ₀	Inner	Outer
			C ₁	e	Y	C ₉₀	C _{a90}	K	N	N			
mm in.	mm in.	mm in.	N lbf			N lbf	N lbf		N lbf				
152.400 6.0000	317.500 12.5000	88.900 3.5000	1220000 274000	0.33	1.84	316000 71100	177000 39700	1.79	1580000 354000			HH234049	HH234018
155.575 6.1250	330.200 13.0000	85.725 3.3750	1230000 276000	0.81	0.74	319000 71600	441000 99200	0.72	1400000 316000			H936340	H936310
155.575 6.1250	336.550 13.2500	85.725 3.3750	1230000 276000	0.81	0.74	319000 71600	441000 99200	0.72	1400000 316000			H936340	H936313
155.575 6.1250	342.900 13.5000	85.725 3.3750	1230000 276000	0.81	0.74	319000 71600	441000 99200	0.72	1400000 316000			H936340	H936316
158.750 6.2500	205.583 8.0938	23.812 0.9375	147000 33000	0.37	1.61	38100 8560	24300 5470	1.57	280000 63000			L432348	L432310
158.750 6.2500	225.425 8.8750	41.275 1.6250	303000 68200	0.38	1.57	78600 17700	51600 11600	1.52	635000 143000			46780	46720
158.750 6.2500	285.750 11.2500	76.200 3.0000	715000 161000	0.40	1.49	185000 41700	128000 28700	1.45	1060000 237000			EE217062X	217112
158.750 6.2500	304.800 12.0000	66.675 2.6250	603000 136000	0.36	1.67	156000 35100	96400 21700	1.62	867000 195000			EE280626	281200
159.950 6.2973	244.475 9.6250	47.625 1.8750	402000 90300	0.35	1.71	104000 23400	62700 14100	1.66	595000 134000			81629	81962
159.950 6.2973	244.475 9.6250	47.625 1.8750	402000 90300	0.35	1.71	104000 23400	62700 14100	1.66	595000 134000			81630	81962
160.000 6.2992	240.000 9.4488	46.000 1.8110	401000 90200	0.44	1.37	104000 23400	77900 17500	1.34	759000 171000			JM734445	JM734410
160.325 6.3120	288.925 11.3750	63.500 2.5000	976000 219000	0.32	1.88	253000 56900	138000 31100	1.83	1240000 278000			HM237532	HM237510
165.100 6.5000	215.900 8.5000	26.195 1.0313	179000 40200	0.36	1.65	46300 10400	28900 6500	1.60	335000 75300			L433749	L433710
165.100 6.5000	225.425 8.8750	41.275 1.6250	303000 68200	0.38	1.57	78600 17700	51600 11600	1.52	635000 143000			46790	46720
165.100 6.5000	225.425 8.8750	41.275 1.6250	303000 68200	0.38	1.57	78600 17700	51600 11600	1.52	635000 143000			46790A	46720
165.100 6.5000	247.650 9.7500	47.625 1.8750	405000 91100	0.44	1.36	105000 23600	79000 17800	1.33	779000 175000			67780	67720
165.100 6.5000	254.000 10.0000	46.038 1.8125	498000 112000	0.37	1.62	129000 29000	81600 18300	1.58	644000 145000			86650	86100

⁽¹⁾Based on 1 x 10⁶ revolutions L₁₀ life, for the ISO life-calculation method.

⁽²⁾Consult your Timken engineer for instructions on use or review the Timken Engineering Manual on timken.com/catalogs.

⁽³⁾Based on 90 x 10⁶ revolutions L₁₀ life, for The Timken Company life-calculation method. C₉₀ and C_{a90} are radial and thrust values.

Bearing Dimensions											Geometry Factors			Bearing Weight
Width B	Width C	Eff. Ctr. a ⁽⁴⁾	Shaft			Housing			Cage		G ₁	G ₂	C _g	
			Max Shaft Fillet Radius R ⁽⁵⁾	Backing Shoulder Dia. d _a	mm in.	Max Housing Fillet Radius r ⁽⁵⁾	Backing Shoulder Dia. D _a	mm in.	A _a ⁽⁶⁾	A _b ⁽⁷⁾				
mm in.	mm in.	mm in.	mm in.	mm in.	mm in.	mm in.	mm in.	mm in.	mm in.	mm in.			kg lbs.	
93.662 3.6875	66.675 2.6250	-26.4 -1.04	9.7 0.38	179.1 7.05	191.0 7.52	6.8 0.27	285.5 11.24	279.9 11.02	10.5 0.41	0.8 0.04	718.4	62.1	0.1157	31.42 69.26
79.375 3.1250	53.975 2.1250	16.8 0.66	6.4 0.25	192.4 7.58	209.0 8.23	6.4 0.25	311.4 12.26	282.0 11.10	18.4 0.72	9.2 0.37	637.7	69.1	0.1475	31.74 69.97
79.375 3.1250	53.975 2.1250	16.8 0.66	6.4 0.25	192.4 7.58	209.0 8.23	6.4 0.25	311.0 12.24	285.0 11.22	18.4 0.72	9.2 0.37	637.7	69.1	0.1475	33.15 73.07
79.375 3.1250	53.975 2.1250	16.8 0.66	6.4 0.25	192.4 7.58	209.0 8.23	6.4 0.25	311.4 12.26	287.0 11.30	18.4 0.72	9.2 0.37	637.7	69.1	0.1475	34.46 75.96
23.812 0.9375	18.258 0.7188	9.4 0.37	4.8 0.19	166.0 6.54	174.0 6.85	1.5 0.06	199.0 7.83	195.0 7.68	2.0 0.08	1.2 0.05	319.5	177.3	0.1683	1.86 4.10
39.688 1.5625	33.338 1.3125	2.5 0.10	3.5 0.14	169.0 6.65	176.0 6.93	3.3 0.13	218.0 8.58	209.0 8.23	3.9 0.15	2.0 0.08	572.0	174.7	0.1432	5.15 11.37
73.025 2.8750	55.562 2.1875	-15.0 -0.59	13.5 0.53	176.0 6.93	200.0 7.87	6.4 0.25	260.4 10.25	251.0 9.88	14.9 0.58	1.7 0.07	556.3	71.8	0.1140	18.42 40.61
69.106 2.7207	42.862 1.6875	-12.2 -0.48	6.4 0.25	180.0 7.09	192.0 7.56	3.3 0.13	282.5 11.12	279.0 10.98	15.1 0.59	0.9 0.04	591.3	86.0	0.1115	19.79 43.62
50.005 1.9687	33.338 1.3125	-5.3 -0.21	3.5 0.14	165.0 6.50	176.0 6.93	3.3 0.13	229.1 9.02	225.0 8.86	8.2 0.32	0.0 0.00	413.0	98.4	0.1250	7.06 15.56
46.830 1.8437	33.338 1.3125	-5.3 -0.21	3.5 0.14	170.9 6.73	176.0 6.93	3.3 0.13	229.1 9.02	225.0 8.86	8.2 0.32	3.1 0.13	413.0	98.4	0.1250	6.92 15.25
44.500 1.7520	37.000 1.4567	5.1 0.20	3.0 0.12	173.0 6.81	178.0 7.01	2.5 0.10	232.0 9.13	222.0 8.74	2.6 0.10	4.1 0.16	548.5	117.5	0.1164	7.14 15.73
63.500 2.5000	47.625 1.8750	-11.7 -0.46	7.0 0.28	181.0 7.13	192.0 7.56	3.3 0.13	271.3 10.68	266.0 10.47	5.8 0.23	4.1 0.16	751.2	101.5	0.1168	17.47 38.53
26.195 1.0313	20.638 0.8125	8.6 0.34	1.5 0.06	172.0 6.77	174.0 6.85	1.5 0.06	209.0 8.23	205.0 8.07	2.4 0.09	1.5 0.06	365.1	168.0	0.1748	2.36 5.19
39.688 1.5625	33.338 1.3125	2.5 0.10	3.5 0.14	174.0 6.85	181.0 7.13	3.3 0.13	218.0 8.58	209.0 8.23	3.9 0.15	2.0 0.08	572.0	174.7	0.1432	4.64 10.23
39.688 1.5625	33.338 1.3125	2.5 0.10	8.0 0.31	174.0 6.85	189.0 7.44	3.3 0.13	218.0 8.58	209.0 8.23	3.9 0.15	2.0 0.08	572.0	174.7	0.1432	4.53 10.00
47.625 1.8750	38.100 1.5000	4.8 0.19	3.5 0.14	179.0 7.05	185.0 7.28	3.3 0.13	240.0 9.45	229.0 9.02	4.8 0.19	1.8 0.07	622.3	122.6	0.1214	7.96 17.56
46.038 1.8125	33.338 1.3125	-1.5 -0.06	4.8 0.19	176.0 6.93	185.0 7.28	3.3 0.13	239.0 9.41	234.0 9.21	6.8 0.27	2.0 0.08	466.3	111.9	0.1041	7.58 16.72

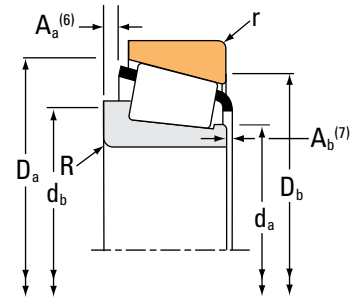
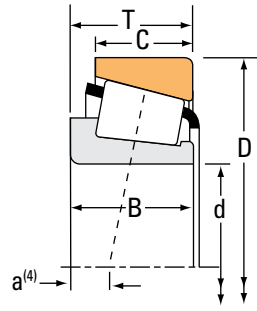
(4) Negative value indicates effective center inside cone (inner-ring) backface.
 (5) These maximum fillet radii will be cleared by the bearing corners.
 (6) Negative value indicates cage extends beyond cone (inner-ring) backface.
 (7) Negative value indicates cage that does not extend beyond cone (inner-ring) front face.

Continued on next page.

TAPERED ROLLER BEARINGS

SINGLE-ROW • TYPE TS

TYPE TS



Bearing Dimensions			Load Ratings							Part Number			
Bore d	O.D. D	Width T	Dynamic ⁽¹⁾		Factors ⁽²⁾		Dynamic ⁽³⁾		Factors ⁽²⁾		Static C ₀	Inner	Outer
			C ₁	e	Y	C ₉₀	C _{a90}	K	N	N			
mm in.	mm in.	mm in.	N lbf			N lbf	N lbf		N lbf				
165.100 6.5000	288.925 11.3750	63.500 2.5000	660000 148000	0.47	1.28	171000 38500	137000 30800	1.25	1070000 242000		94649	94113	
165.100 6.5000	288.925 11.3750	63.500 2.5000	976000 219000	0.32	1.88	253000 56900	138000 31100	1.83	1240000 278000		HM237535	HM237510	
165.100 6.5000	288.925 11.3750	63.500 2.5000	976000 219000	0.32	1.88	253000 56900	138000 31100	1.83	1240000 278000		HM237536	HM237510	
165.100 6.5000	298.450 11.7500	82.550 3.2500	927000 208000	0.38	1.59	240000 54000	155000 34900	1.55	1520000 341000		EE219065	219117	
165.100 6.5000	311.150 12.2500	82.550 3.2500	927000 208000	0.38	1.59	240000 54000	155000 34900	1.55	1520000 341000		EE219065	219122	
165.100 6.5000	311.150 12.2500	82.550 3.2500	1060000 238000	0.33	1.81	274000 61600	155000 34900	1.77	1680000 378000		H238140	H238110	
165.100 6.5000	336.550 13.2500	92.075 3.6250	1660000 372000	0.37	1.62	429000 96500	273000 61400	1.57	1930000 434000		HH437549	HH437510	
165.100 6.5000	361.950 14.2500	106.362 4.1875	1450000 325000	0.33	1.79	375000 84200	215000 48300	1.74	1950000 439000		EE108065	108142	
165.100 6.5000	365.049 14.3720	92.075 3.6250	1170000 263000	0.40	1.49	303000 68100	208000 46800	1.45	1820000 409000		EE420651	421437	
166.688 6.5625	225.425 8.8750	41.275 1.6250	303000 68200	0.38	1.57	78600 17700	51600 11600	1.52	635000 143000		46792	46720	
168.275 6.6250	247.650 9.7500	47.625 1.8750	405000 91100	0.44	1.36	105000 23600	79000 17800	1.33	779000 175000		67782	67720	
168.275 6.6250	330.200 13.0000	85.725 3.3750	1230000 276000	0.81	0.74	319000 71600	441000 99200	0.72	1400000 316000		H936349	H936310	
168.275 6.6250	342.900 13.5000	85.725 3.3750	1230000 276000	0.81	0.74	319000 71600	441000 99200	0.72	1400000 316000		H936349	H936316	
170.000 6.6929	230.000 9.0551	39.000 1.5354	335000 75300	0.38	1.57	86800 19500	56900 12800	1.52	590000 133000		JHM534149	JHM534110	
170.000 6.6929	240.000 9.4488	46.000 1.8110	401000 90200	0.44	1.37	104000 23400	77900 17500	1.34	759000 171000		JM734449	JM734410	
170.000 6.6929	254.000 10.0000	46.038 1.8125	498000 112000	0.37	1.62	129000 29000	81600 18300	1.58	644000 145000		86669	86100	
170.000 6.6929	254.000 10.0000	46.038 1.8125	513000 115000	0.32	1.88	133000 29900	72600 16300	1.83	740000 166000		M235149	M235113	

⁽¹⁾Based on 1 x 10⁶ revolutions L₁₀ life, for the ISO life-calculation method.

⁽²⁾Consult your Timken engineer for instructions on use or review the Timken Engineering Manual on timken.com/catalogs.

⁽³⁾Based on 90 x 10⁶ revolutions L₁₀ life, for The Timken Company life-calculation method. C₉₀ and C_{a90} are radial and thrust values.

Bearing Dimensions											Geometry Factors			Bearing Weight
Width B	Width C	Eff. Ctr. a ⁽⁴⁾	Shaft			Housing			Cage		G ₁	G ₂	C _g	
			Max Shaft Fillet Radius R ⁽⁵⁾	Backing Shoulder Dia. d _a	Backing Shoulder Dia. d _b	Max Housing Fillet Radius r ⁽⁵⁾	Backing Shoulder Dia. D _a	Backing Shoulder Dia. D _b	A _a ⁽⁶⁾	A _b ⁽⁷⁾				
mm in.	mm in.	mm in.	mm in.	mm in.	mm in.	mm in.	mm in.	mm in.	mm in.	mm in.				kg lbs.
63.500 2.5000	47.625 1.8750	-0.8 -0.03	7.0 0.28	186.0 7.32	197.0 7.76	3.3 0.13	272.0 10.71	259.0 10.20	6.8 0.26	5.3 0.21	692.3	93.9	0.1287	17.11 37.71
63.500 2.5000	47.625 1.8750	-11.7 -0.46	7.0 0.28	184.0 7.24	195.0 7.68	3.3 0.13	271.3 10.68	266.0 10.47	5.8 0.23	4.1 0.16	751.2	101.5	0.1168	16.86 37.18
63.500 2.5000	47.625 1.8750	-11.7 -0.46	7.0 0.28	187.0 7.36	195.0 7.68	3.3 0.13	271.3 10.68	266.0 10.47	5.8 0.23	4.1 0.16	751.2	101.5	0.1168	16.78 37.01
82.550 3.2500	63.500 2.5000	-15.2 -0.60	6.4 0.25	185.0 7.28	196.0 7.72	6.4 0.25	282.0 11.10	269.0 10.59	9.9 0.39	0.3 0.01	841.4	94.9	0.1286	23.83 52.54
82.550 3.2500	63.500 2.5000	-15.2 -0.60	6.4 0.25	185.0 7.28	196.0 7.72	6.4 0.25	282.0 11.10	275.0 10.83	9.9 0.39	0.3 0.01	841.4	94.9	0.1286	26.95 59.41
82.550 3.2500	65.088 2.5625	-18.5 -0.73	6.4 0.25	188.0 7.40	198.0 7.80	6.4 0.25	289.0 11.36	280.0 11.02	8.2 0.32	2.2 0.09	913.6	92.2	0.1265	27.34 60.28
95.250 3.7500	69.850 2.7500	-21.3 -0.84	3.3 0.13	196.0 7.72	196.0 7.72	6.4 0.25	307.7 12.12	297.0 11.69	11.7 0.46	1.0 0.04	909.5	75.1	0.1310	37.31 82.25
104.775 4.1250	76.200 3.0000	-32.8 -1.29	13.5 0.53	194.0 7.64	215.0 8.46	3.3 0.13	328.9 12.95	323.0 12.72	16.8 0.66	5.6 0.22	941.7	71.4	0.1274	49.11 108.30
88.897 3.4999	63.500 2.5000	-15.5 -0.61	9.7 0.38	199.0 7.83	215.0 8.46	3.3 0.13	334.4 13.16	329.0 12.95	19.1 0.75	2.5 0.10	1150.5	128.2	0.1450	44.51 98.14
39.688 1.5625	33.338 1.3125	2.5 0.10	3.5 0.14	175.0 6.89	182.0 7.17	3.3 0.13	218.0 8.58	209.0 8.23	3.9 0.15	2.0 0.08	572.0	174.7	0.1432	4.53 9.98
47.625 1.8750	38.100 1.5000	4.8 0.19	3.5 0.14	181.0 7.13	187.0 7.36	3.3 0.13	240.0 9.45	229.0 9.02	4.8 0.19	1.8 0.07	622.3	122.6	0.1214	7.65 16.88
79.375 3.1250	53.975 2.1250	16.8 0.66	6.4 0.25	192.4 7.58	218.0 8.58	6.4 0.25	311.4 12.26	282.0 11.10	18.4 0.72	9.2 0.37	637.7	69.1	0.1475	29.73 65.53
79.375 3.1250	53.975 2.1250	16.8 0.66	6.4 0.25	192.4 7.58	218.0 8.58	6.4 0.25	311.4 12.26	287.0 11.30	18.4 0.72	9.2 0.37	637.7	69.1	0.1475	32.45 71.53
38.000 1.4961	31.000 1.2205	4.6 0.18	3.0 0.12	178.0 7.01	184.0 7.24	2.5 0.10	224.0 8.82	217.0 8.54	1.0 0.04	3.4 0.14	479.6	89.8	0.1350	4.30 9.46
44.500 1.7520	37.000 1.4567	5.1 0.20	3.0 0.12	180.0 7.09	185.0 7.28	2.5 0.10	232.0 9.13	222.0 8.74	2.6 0.10	4.1 0.16	548.5	117.5	0.1164	6.25 13.76
46.038 1.8125	33.338 1.3125	-1.5 -0.06	4.8 0.19	180.0 7.09	189.0 7.44	3.3 0.13	239.0 9.41	234.0 9.21	6.8 0.27	2.0 0.08	466.3	111.9	0.1041	7.12 15.69
46.038 1.8125	33.338 1.3125	-4.6 -0.18	4.8 0.19	182.0 7.17	189.0 7.44	3.3 0.13	240.0 9.45	235.0 9.25	4.8 0.19	3.0 0.12	531.4	107.5	0.1037	7.33 16.14

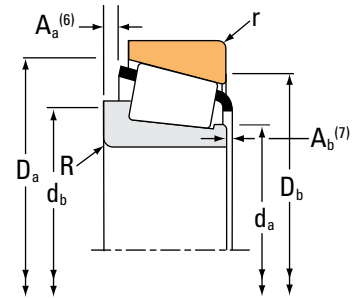
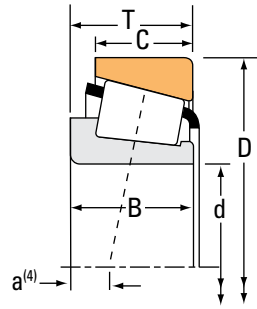
⁽⁴⁾Negative value indicates effective center inside cone (inner-ring) backface.
⁽⁵⁾These maximum fillet radii will be cleared by the bearing corners.
⁽⁶⁾Negative value indicates cage extends beyond cone (inner-ring) backface.
⁽⁷⁾Negative value indicates cage that does not extend beyond cone (inner-ring) front face.

Continued on next page.

TAPERED ROLLER BEARINGS

SINGLE-ROW • TYPE TS

TYPE TS



Bearing Dimensions			Load Ratings							Part Number			
Bore d	O.D. D	Width T	Dynamic ⁽¹⁾		Factors ⁽²⁾		Dynamic ⁽³⁾		Factors ⁽²⁾		Static C ₀	Inner	Outer
			C ₁	e	Y	C ₉₀	C _{a90}	K	N	N			
mm in.	mm in.	mm in.	N lbf			N lbf	N lbf		N lbf				
171.450 6.7500	260.350 10.2500	66.675 2.6250	654000 147000	0.40	1.49	169000 38100	117000 26200	1.45	1180000 265000			HM535349	HM535310
174.625 6.8750	247.650 9.7500	47.625 1.8750	405000 91100	0.44	1.36	105000 23600	79000 17800	1.33	779000 175000			67787	67720
174.625 6.8750	247.650 9.7500	47.625 1.8750	405000 91100	0.44	1.36	105000 23600	79000 17800	1.33	779000 175000			67786	67720
174.625 6.8750	260.350 10.2500	53.975 2.1250	537000 121000	0.33	1.80	139000 31300	79200 17800	1.76	933000 210000			M236845	M236810
174.625 6.8750	288.925 11.3750	63.500 2.5000	660000 148000	0.47	1.28	171000 38500	137000 30800	1.25	1070000 242000			94687	94113
174.625 6.8750	298.450 11.7500	82.550 3.2500	927000 208000	0.38	1.59	240000 54000	155000 34900	1.55	1520000 341000			EE219068	219117
174.625 6.8750	311.150 12.2500	82.550 3.2500	927000 208000	0.38	1.59	240000 54000	155000 34900	1.55	1520000 341000			EE219068	219122
174.625 6.8750	311.150 12.2500	82.550 3.2500	1120000 252000	0.33	1.81	290000 65200	164000 36900	1.77	1680000 378000			H238148	H238110
177.800 7.0000	215.900 8.5000	20.638 0.8125	122000 27500	0.45	1.33	31700 7130	24500 5500	1.30	252000 56600			LL735449	LL735410
177.800 7.0000	247.650 9.7500	47.625 1.8750	405000 91100	0.44	1.36	105000 23600	79000 17800	1.33	779000 175000			67790	67720
177.800 7.0000	247.650 9.7500	47.625 1.8750	405000 91100	0.44	1.36	105000 23600	79000 17800	1.33	779000 175000			67791	67720
177.800 7.0000	260.350 10.2500	53.975 2.1250	537000 121000	0.33	1.80	139000 31300	79200 17800	1.76	933000 210000			M236849	M236810
177.800 7.0000	260.350 10.2500	53.975 2.1250	537000 121000	0.33	1.80	139000 31300	79200 17800	1.76	933000 210000			M236848	M236810
177.800 7.0000	269.875 10.6250	55.562 2.1875	508000 114000	0.33	1.80	132000 29600	74900 16800	1.76	999000 225000			M238840	M238810
177.800 7.0000	288.925 11.3750	63.500 2.5000	660000 148000	0.47	1.28	171000 38500	137000 30800	1.25	1070000 242000			94700	94113
177.800 7.0000	288.925 11.3750	63.500 2.5000	976000 219000	0.32	1.88	253000 56900	138000 31100	1.83	1240000 278000			HM237545	HM237510
177.800 7.0000	298.450 11.7500	63.500 2.5000	660000 148000	0.47	1.28	171000 38500	137000 30800	1.25	1070000 242000			94700	94118

⁽¹⁾Based on 1 x 10⁶ revolutions L₁₀ life, for the ISO life-calculation method.

⁽²⁾Consult your Timken engineer for instructions on use or review the Timken Engineering Manual on timken.com/catalogs.

⁽³⁾Based on 90 x 10⁶ revolutions L₁₀ life, for The Timken Company life-calculation method. C₉₀ and C_{a90} are radial and thrust values.

Bearing Dimensions											Geometry Factors			Bearing Weight
Width B	Width C	Eff. Ctr. a ⁽⁴⁾	Shaft			Housing			Cage		G ₁	G ₂	C _g	
			Max Shaft Fillet Radius R ⁽⁵⁾	Backing Shoulder Dia. d _a d _b		Max Housing Fillet Radius r ⁽⁵⁾	Backing Shoulder Dia. D _a D _b		A _a ⁽⁶⁾	A _b ⁽⁷⁾				
mm in.	mm in.	mm in.	mm in.	mm in.	mm in.	mm in.	mm in.	mm in.	mm in.	mm in.				kg lbs.
66.675 2.6250	52.388 2.0625	-8.6 -0.34	3.5 0.14	186.1 7.40	192.0 7.56	3.3 0.13	250.0 9.84	236.0 9.29	6.0 0.23	2.2 0.09	749.5	115.6	0.1263	12.20 26.90
47.625 1.8750	38.100 1.5000	4.8 0.19	3.5 0.14	185.0 7.28	192.0 7.56	3.3 0.13	240.0 9.45	229.0 9.02	4.8 0.19	1.8 0.07	622.3	122.6	0.1214	7.01 15.47
47.625 1.8750	38.100 1.5000	4.8 0.19	8.0 0.31	185.0 7.28	200.0 7.87	3.3 0.13	240.0 9.45	229.0 9.02	4.8 0.19	1.8 0.07	622.3	122.6	0.1214	6.97 15.37
53.975 2.1250	41.275 1.6250	-6.6 -0.26	3.5 0.14	189.0 7.44	193.0 7.60	3.3 0.13	249.0 9.80	241.0 9.49	4.6 0.18	3.3 0.13	690.9	100.2	0.1150	9.46 20.84
63.500 2.5000	47.625 1.8750	-0.8 -0.03	7.0 0.28	193.0 7.60	204.0 8.03	3.3 0.13	272.0 10.71	259.0 10.20	6.8 0.26	5.3 0.21	692.3	93.9	0.1287	15.78 34.77
82.550 3.2500	63.500 2.5000	-15.2 -0.60	6.4 0.25	193.0 7.60	204.0 8.03	6.4 0.25	282.0 11.10	269.0 10.59	9.9 0.39	0.3 0.01	841.4	94.9	0.1286	22.18 48.91
82.550 3.2500	63.500 2.5000	-15.2 -0.60	6.4 0.25	193.0 7.60	204.0 8.03	6.4 0.25	282.0 11.10	275.0 10.83	9.9 0.39	0.3 0.01	841.4	94.9	0.1286	25.30 55.78
82.550 3.2500	65.088 2.5625	-18.5 -0.73	6.4 0.25	195.0 7.68	205.0 8.07	6.4 0.25	289.0 11.36	280.0 11.02	8.2 0.32	2.2 0.09	913.6	92.2	0.1265	25.70 56.66
20.638 0.8125	15.083 0.5938	17.8 0.70	1.5 0.06	184.0 7.24	186.0 7.32	1.5 0.06	212.0 8.35	207.0 8.15	1.2 0.05	1.6 0.07	345.8	240.8	0.1825	1.43 3.14
47.625 1.8750	38.100 1.5000	4.8 0.19	3.5 0.14	188.0 7.40	194.0 7.64	3.3 0.13	240.0 9.45	229.0 9.02	4.8 0.19	1.8 0.07	622.3	122.6	0.1214	6.69 14.75
47.625 1.8750	38.100 1.5000	4.8 0.19	10.5 0.41	188.0 7.40	208.0 8.19	3.3 0.13	240.0 9.45	229.0 9.02	4.8 0.19	1.8 0.07	622.3	122.6	0.1214	6.59 14.54
53.975 2.1250	41.275 1.6250	-6.6 -0.26	3.5 0.14	191.0 7.52	195.0 7.68	3.3 0.13	249.0 9.80	241.0 9.49	4.6 0.18	3.3 0.13	690.9	100.2	0.1150	9.10 20.06
53.975 2.1250	41.275 1.6250	-6.6 -0.26	8.0 0.31	191.0 7.52	204.0 8.03	3.3 0.13	249.0 9.80	241.0 9.49	4.6 0.18	3.3 0.13	690.9	100.2	0.1150	9.06 19.96
55.562 2.1875	42.862 1.6875	-6.1 -0.24	3.5 0.14	194.0 7.64	198.0 7.80	3.3 0.13	256.0 10.08	250.0 9.84	5.8 0.23	2.1 0.09	788.3	118.1	0.1201	11.00 24.26
63.500 2.5000	47.625 1.8750	-0.8 -0.03	7.0 0.28	195.0 7.68	207.0 8.15	3.3 0.13	272.0 10.71	259.0 10.20	6.8 0.26	5.3 0.21	692.3	93.9	0.1287	15.40 33.95
63.500 2.5000	47.625 1.8750	-11.7 -0.46	7.0 0.28	194.0 7.64	205.0 8.07	3.3 0.13	271.3 10.68	266.0 10.47	5.8 0.23	4.1 0.16	751.2	101.5	0.1168	15.15 33.43
63.500 2.5000	47.625 1.8750	-0.8 -0.03	7.0 0.28	195.0 7.68	207.0 8.15	3.3 0.13	272.0 10.71	263.0 10.35	6.8 0.26	5.3 0.21	692.3	93.9	0.1287	17.00 37.48

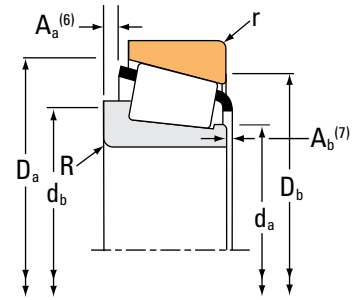
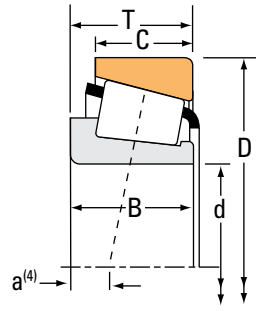
(4) Negative value indicates effective center inside cone (inner-ring) backface.
 (5) These maximum fillet radii will be cleared by the bearing corners.
 (6) Negative value indicates cage extends beyond cone (inner-ring) backface.
 (7) Negative value indicates cage that does not extend beyond cone (inner-ring) front face.

Continued on next page.

TAPERED ROLLER BEARINGS

SINGLE-ROW • TYPE TS

TYPE TS



Bearing Dimensions			Load Ratings							Part Number			
Bore d	O.D. D	Width T	Dynamic ⁽¹⁾		Factors ⁽²⁾		Dynamic ⁽³⁾		Factors ⁽²⁾		Static C ₀	Inner	Outer
			C ₁	e	Y	C ₉₀	C _{a90}	K	N	N			
mm in.	mm in.	mm in.	N lbf			N lbf	N lbf		N lbf				
177.800 7.0000	319.964 12.5970	88.900 3.5000	1050000 236000	0.32	1.88	272000 61100	148000 33400	1.83	1580000 356000			H239640	H239610
177.800 7.0000	320.675 12.6250	88.900 3.5000	1050000 236000	0.32	1.88	272000 61100	148000 33400	1.83	1580000 356000			H239640	H239612
177.800 7.0000	327.025 12.8750	90.488 3.5625	1020000 229000	0.37	1.64	264000 59200	165000 37100	1.60	1580000 354000			EE470078X	470128
177.800 7.0000	330.200 13.0000	90.488 3.5625	1020000 229000	0.37	1.64	264000 59200	165000 37100	1.60	1580000 354000			EE470078X	470130
177.800 7.0000	330.200 13.0000	90.488 3.5625	1020000 229000	0.37	1.64	264000 59200	165000 37100	1.60	1580000 354000			EE470073	470130
177.800 7.0000	336.550 13.2500	90.488 3.5625	1020000 229000	0.37	1.64	264000 59200	165000 37100	1.60	1580000 354000			EE470073	470132
177.800 7.0000	355.600 14.0000	61.912 2.4375	876000 197000	0.40	1.50	227000 51100	155000 34900	1.46	1080000 243000			EE780705	781400
177.800 7.0000	360.000 14.1732	92.075 3.6250	1170000 263000	0.40	1.49	303000 68100	208000 46800	1.45	1820000 409000			EE420701	421417
177.800 7.0000	365.049 14.3720	92.075 3.6250	1170000 263000	0.40	1.49	303000 68100	208000 46800	1.45	1820000 409000			EE420701	421437
177.800 7.0000	368.300 14.5000	92.075 3.6250	1170000 263000	0.40	1.49	303000 68100	208000 46800	1.45	1820000 409000			EE420701	421450
177.800 7.0000	428.625 16.8750	106.362 4.1875	1500000 338000	0.76	0.79	390000 87600	506000 114000	0.77	1700000 382000			EE350701	351687
179.975 7.0856	317.500 12.5000	63.500 2.5000	731000 164000	0.52	1.15	190000 42600	170000 38200	1.12	1290000 290000			93708	93125
180.000 7.0866	250.000 9.8425	47.000 1.8504	409000 92000	0.48	1.25	106000 23800	87200 19600	1.22	786000 177000			JM736149	JM736110
180.000 7.0866	250.000 9.8425	47.000 1.8504	409000 92000	0.48	1.25	106000 23800	87200 19600	1.22	786000 177000			JM736149A	JM736110
184.150 7.2500	234.950 9.2500	34.000 1.3386	284000 63800	0.33	1.79	73600 16500	42200 9480	1.74	550000 124000			LM236749	LM236710
184.150 7.2500	235.229 9.2610	34.000 1.3386	284000 63800	0.33	1.79	73600 16500	42200 9480	1.74	550000 124000			LM236749	LM236710A
184.150 7.2500	236.538 9.3125	26.193 1.0312	174000 39000	0.40	1.49	45000 10100	31000 6960	1.45	337000 75700			LL537649	LL537610

⁽¹⁾Based on 1×10^6 revolutions L_{10} life, for the ISO life-calculation method.

⁽²⁾Consult your Timken engineer for instructions on use or review the Timken Engineering Manual on timken.com/catalogs.

⁽³⁾Based on 90×10^6 revolutions L_{10} life, for The Timken Company life-calculation method. C_{90} and C_{a90} are radial and thrust values.

Bearing Dimensions											Geometry Factors			Bearing Weight
Width B	Width C	Eff. Ctr. a ⁽⁴⁾	Shaft			Housing			Cage		G ₁	G ₂	C _g	
			Max Shaft Fillet Radius R ⁽⁵⁾	Backing Shoulder Dia. d _a	Backing Shoulder Dia. d _b	Max Housing Fillet Radius r ⁽⁵⁾	Backing Shoulder Dia. D _a	Backing Shoulder Dia. D _b	A _a ⁽⁶⁾	A _b ⁽⁷⁾				
mm in.	mm in.	mm in.	mm in.	mm in.	mm in.	mm in.	mm in.	mm in.	mm in.	mm in.				kg lbs.
85.725 3.3750	65.088 2.5625	-22.4 -0.88	3.5 0.14	198.0 7.80	202.0 7.95	4.8 0.19	301.0 11.84	293.0 11.54	11.5 0.45	2.8 0.11	905.7	90.3	0.1242	27.68 61.03
85.725 3.3750	65.088 2.5625	-22.4 -0.88	3.5 0.14	198.0 7.80	202.0 7.95	4.8 0.19	301.0 11.84	293.0 11.54	11.5 0.45	2.8 0.11	905.7	90.3	0.1242	27.87 61.44
92.075 3.6250	63.500 2.5000	-21.8 -0.86	9.7 0.38	201.0 7.91	217.0 8.54	6.4 0.25	306.5 12.07	294.0 11.57	* *	* *	914.1	104.7	0.1304	30.42 67.07
92.075 3.6250	63.500 2.5000	-21.8 -0.86	9.7 0.38	201.0 7.91	217.0 8.54	6.4 0.25	306.5 12.07	295.0 11.61	* *	* *	914.1	104.7	0.1304	31.48 69.40
92.075 3.6250	63.500 2.5000	-21.8 -0.86	13.5 0.53	201.0 7.91	225.0 8.86	6.4 0.25	306.5 12.07	295.0 11.61	13.9 0.54	-0.4 -0.01	914.1	104.7	0.1304	31.28 68.95
92.075 3.6250	63.500 2.5000	-21.8 -0.86	13.5 0.53	201.0 7.91	225.0 8.86	6.4 0.25	306.5 12.07	298.0 11.73	13.9 0.54	-0.4 -0.01	914.1	104.7	0.1304	32.93 72.60
60.325 2.3750	41.275 1.6250	-0.3 -0.01	4.8 0.19	209.0 8.23	207.0 8.15	4.8 0.19	321.1 12.64	320.0 12.60	7.7 0.30	5.5 0.22	646.5	79.5	0.1185	25.51 56.23
88.897 3.4999	63.500 2.5000	-15.5 -0.61	12.7 0.50	208.0 8.19	231.0 9.09	3.3 0.13	334.4 13.16	327.0 12.87	19.1 0.75	2.5 0.10	1150.5	128.2	0.1450	40.54 89.37
88.897 3.4999	63.500 2.5000	-15.5 -0.61	12.7 0.50	208.0 8.19	231.0 9.09	3.3 0.13	334.4 13.16	329.0 12.95	19.1 0.75	2.5 0.10	1150.5	128.2	0.1450	41.96 92.51
88.897 3.4999	63.500 2.5000	-15.5 -0.61	12.7 0.50	208.0 8.19	231.0 9.09	3.3 0.13	334.4 13.16	331.0 13.03	19.1 0.75	2.5 0.10	1150.5	128.2	0.1450	42.89 94.56
95.250 3.7500	61.912 2.4375	13.0 0.51	6.4 0.25	221.0 8.70	230.0 9.06	6.4 0.25	383.0 15.08	365.0 14.37	21.1 0.83	16.1 0.64	827.7	77.3	0.1568	65.70 144.84
63.500 2.5000	46.038 1.8125	7.9 0.31	3.5 0.14	204.0 8.03	209.0 8.23	3.3 0.13	300.0 11.81	286.0 11.26	9.1 0.36	4.3 0.17	912.5	126.1	0.1460	21.24 46.84
45.000 1.7717	37.000 1.4567	8.9 0.35	3.0 0.12	190.5 7.50	196.0 7.72	2.5 0.10	242.6 9.55	232.0 9.13	3.3 0.13	4.1 0.16	589.4	128.0	0.1227	6.67 14.70
45.000 1.7717	37.000 1.4567	8.9 0.35	9.5 0.37	190.0 7.48	209.0 8.23	2.5 0.10	242.6 9.55	232.0 9.13	3.3 0.13	4.1 0.16	589.4	128.0	0.1227	6.61 14.58
33.000 1.2992	28.000 1.1024	5.1 0.20	2.0 0.08	191.0 7.52	195.0 7.68	2.0 0.08	229.0 9.02	224.0 8.82	0.4 0.01	3.6 0.15	558.8	173.3	0.1353	3.35 7.37
33.000 1.2992	28.000 1.1024	5.1 0.20	2.0 0.08	191.0 7.52	195.0 7.68	2.0 0.08	229.0 9.02	224.0 8.82	0.4 0.01	3.6 0.15	558.8	173.3	0.1353	3.38 7.45
25.400 1.0000	19.050 0.7500	13.7 0.54	1.5 0.06	192.0 7.56	194.0 7.64	1.5 0.06	230.0 9.06	225.0 8.86	3.1 0.12	1.4 0.06	418.3	210.9	0.1293	2.59 5.71

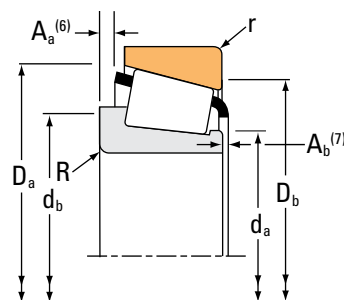
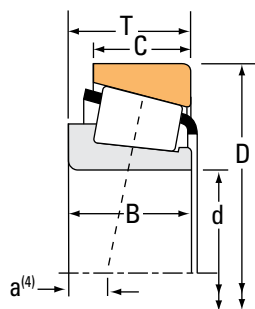
(4) Negative value indicates effective center inside cone (inner-ring) backface.
 (5) These maximum fillet radii will be cleared by the bearing corners.
 (6) Negative value indicates cage extends beyond cone (inner-ring) backface.
 (7) Negative value indicates cage that does not extend beyond cone (inner-ring) front face.
 (*) Contact your Timken engineer for details.

Continued on next page.

TAPERED ROLLER BEARINGS

SINGLE-ROW • TYPE TS

TYPE TS



Bearing Dimensions			Load Ratings							Part Number		
Bore d	O.D. D	Width T	Dynamic ⁽¹⁾		Factors ⁽²⁾		Dynamic ⁽³⁾		Factors ⁽²⁾	Static	Inner	Outer
			C ₁	e	Y	C ₉₀	C _{a90}	K	C ₀			
mm in.	mm in.	mm in.	N lbf			N lbf	N lbf			N lbf		
184.150 7.2500	266.700 10.5000	47.625 1.8750	416000 93600	0.48	1.26	108000 24300	88200 19800	1.22		835000 188000	67883	67820
187.325 7.3750	266.700 10.5000	47.625 1.8750	416000 93600	0.48	1.26	108000 24300	88200 19800	1.22		835000 188000	67884	67820
187.325 7.3750	269.875 10.6250	55.562 2.1875	548000 123000	0.33	1.80	142000 32000	80900 18200	1.76		999000 225000	M238849	M238810
187.325 7.3750	282.575 11.1250	50.800 2.0000	509000 114000	0.42	1.44	132000 29700	93900 21100	1.41		692000 156000	87737	87111
187.325 7.3750	320.675 12.6250	88.900 3.5000	1050000 236000	0.32	1.88	272000 61100	148000 33400	1.83		1580000 356000	H239649	H239612
190.000 7.4803	260.000 10.2362	46.000 1.8110	407000 91500	0.48	1.26	105000 23700	86200 19400	1.22		807000 181000	JM738249	JM738210
190.000 7.4803	269.875 10.6250	55.563 2.1875	548000 123000	0.33	1.80	142000 32000	80900 18200	1.76		999000 225000	JM238848	M238810
190.078 7.4834	289.992 11.4170	46.000 1.8110	416000 93600	0.48	1.26	108000 24300	88200 19800	1.22		835000 188000	67886	67835
190.500 7.5000	266.700 10.5000	47.625 1.8750	416000 93600	0.48	1.26	108000 24300	88200 19800	1.22		835000 188000	67885	67820
190.500 7.5000	282.575 11.1250	50.800 2.0000	509000 114000	0.42	1.44	132000 29700	93900 21100	1.41		692000 156000	87750	87111
190.500 7.5000	284.162 11.1875	55.562 2.1875	577000 130000	0.36	1.68	150000 33600	91500 20600	1.63		1060000 239000	82788	82722
190.500 7.5000	288.925 11.3750	55.562 2.1875	577000 130000	0.36	1.68	150000 33600	91500 20600	1.63		1060000 239000	82788	82720
190.500 7.5000	317.500 12.5000	63.500 2.5000	731000 164000	0.52	1.15	190000 42600	170000 38200	1.12		1290000 290000	93750	93125
190.500 7.5000	327.025 12.8750	90.488 3.5625	1020000 229000	0.37	1.64	264000 59200	165000 37100	1.60		1580000 354000	EE470075	470128
190.500 7.5000	330.200 13.0000	63.500 2.5000	678000 152000	0.38	1.56	176000 39500	116000 26000	1.52		1050000 235000	EE210753	211300
190.500 7.5000	336.550 13.2500	90.488 3.5625	1020000 229000	0.37	1.64	264000 59200	165000 37100	1.60		1580000 354000	EE470075	470132
190.500 7.5000	336.550 13.2500	98.425 3.8750	1150000 259000	0.58	1.04	299000 67100	294000 66200	1.01		2050000 460000	HH840249	HH840210

⁽¹⁾Based on 1×10^6 revolutions L_{10} life, for the ISO life-calculation method.

⁽²⁾Consult your Timken engineer for instructions on use or review the Timken Engineering Manual on timken.com/catalogs.

⁽³⁾Based on 90×10^6 revolutions L_{10} life, for The Timken Company life-calculation method. C_{90} and C_{a90} are radial and thrust values.

Bearing Dimensions											Geometry Factors			Bearing Weight
Width B	Width C	Eff. Ctr. a ⁽⁴⁾	Shaft			Housing			Cage		G ₁	G ₂	C _g	
			Max Shaft Fillet Radius R ⁽⁵⁾	Backing Shoulder Dia. d _a	Shoulder Dia. d _b	Max Housing Fillet Radius r ⁽⁵⁾	Backing Shoulder Dia. D _a	Shoulder Dia. D _b	A _a ⁽⁶⁾	A _b ⁽⁷⁾				
mm in.	mm in.	mm in.	mm in.	mm in.	mm in.	mm in.	mm in.	mm in.	mm in.	mm in.				kg lbs.
46.833 1.8438	38.100 1.5000	10.2 0.40	3.5 0.14	198.0 7.80	204.0 8.03	3.3 0.13	259.0 10.20	246.0 9.69	5.0 0.20	1.8 0.08	727.9	146.6	0.1310	8.65 19.07
46.833 1.8438	38.100 1.5000	10.2 0.40	3.5 0.14	201.0 7.91	206.0 8.11	3.3 0.13	259.0 10.20	246.0 9.69	5.0 0.20	1.8 0.08	727.9	146.6	0.1310	8.29 18.28
55.562 2.1875	42.862 1.6875	-6.1 -0.24	3.5 0.14	201.0 7.91	205.0 8.07	3.3 0.13	256.0 10.08	250.0 9.84	5.8 0.23	2.1 0.09	788.3	118.1	0.1201	9.82 21.64
47.625 1.8750	36.512 1.4375	3.8 0.15	3.5 0.14	201.0 7.91	207.0 8.15	3.3 0.13	267.0 10.50	261.0 10.28	8.7 0.34	2.7 0.11	574.6	130.8	0.1155	9.82 21.64
85.725 3.3750	65.088 2.5625	-22.4 -0.88	5.5 0.22	205.0 8.07	214.0 8.43	4.8 0.19	301.0 11.84	293.0 11.54	11.5 0.45	2.8 0.11	905.7	90.3	0.1242	26.02 57.35
44.000 1.7323	36.500 1.4370	10.9 0.43	3.0 0.12	200.0 7.87	206.0 8.11	2.5 0.10	252.0 9.92	242.0 9.53	3.2 0.12	4.0 0.16	653.1	146.7	0.1265	6.85 15.09
55.562 2.1875	42.862 1.6875	-6.1 -0.24	3.0 0.12	203.0 7.99	206.0 8.11	3.3 0.13	256.0 10.08	250.0 9.84	5.8 0.23	2.1 0.09	788.3	118.1	0.1201	9.51 20.96
46.000 1.8110	36.000 1.4173	10.7 0.42	6.4 0.25	203.0 7.99	214.0 8.43	3.3 0.13	259.0 10.20	256.0 10.08	4.5 0.18	2.2 0.09	727.9	146.6	0.1310	10.56 23.29
46.833 1.8438	38.100 1.5000	10.2 0.40	3.5 0.14	203.0 7.99	209.0 8.23	3.3 0.13	259.0 10.20	246.0 9.69	5.0 0.20	1.8 0.08	727.9	146.6	0.1310	7.96 17.56
47.625 1.8750	36.512 1.4375	3.8 0.15	3.5 0.14	203.0 7.99	209.0 8.23	3.3 0.13	267.0 10.50	261.0 10.28	8.7 0.34	2.7 0.11	574.6	130.8	0.1155	9.49 20.91
55.562 2.1875	42.862 1.6875	-2.8 -0.11	3.5 0.14	203.0 7.99	210.0 8.27	3.3 0.13	271.0 10.67	263.0 10.35	5.2 0.20	2.3 0.09	804.7	110.8	0.1238	11.55 25.46
55.562 2.1875	42.862 1.6875	-2.8 -0.11	3.5 0.14	203.0 7.99	210.0 8.27	3.3 0.13	271.0 10.67	265.0 10.43	5.2 0.20	2.3 0.09	804.7	110.8	0.1238	12.30 27.11
63.500 2.5000	46.038 1.8125	7.9 0.31	4.3 0.17	212.0 8.35	218.0 8.58	3.3 0.13	300.0 11.81	286.0 11.26	9.1 0.36	4.3 0.17	912.5	126.1	0.1460	19.74 43.52
92.075 3.6250	63.500 2.5000	-21.8 -0.86	6.4 0.25	210.0 8.27	220.0 8.66	6.4 0.25	306.5 12.07	294.0 11.57	* *	* *	914.1	104.7	0.1304	27.89 61.49
61.912 2.4375	42.862 1.6875	-4.6 -0.18	7.0 0.28	210.0 8.27	221.0 8.70	3.3 0.13	300.0 11.81	299.0 11.77	11.6 0.45	4.0 0.16	736.7	115.8	0.1227	19.85 43.75
92.075 3.6250	63.500 2.5000	-21.8 -0.86	6.4 0.25	210.0 8.27	220.0 8.66	6.4 0.25	306.5 12.07	298.0 11.73	* *	* *	914.1	104.7	0.1304	30.60 67.48
95.250 3.7500	73.025 2.8750	-5.6 -0.22	6.4 0.25	215.7 8.49	234.0 9.21	6.4 0.25	318.0 12.52	290.0 11.42	14.4 0.56	5.2 0.21	1088.1	104.3	0.1605	35.64 78.56

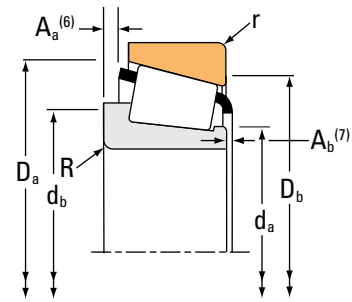
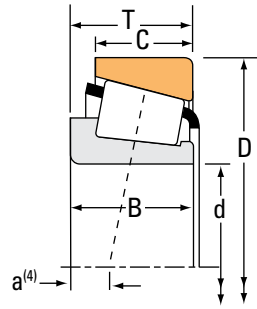
(4) Negative value indicates effective center inside cone (inner-ring) backface.
 (5) These maximum fillet radii will be cleared by the bearing corners.
 (6) Negative value indicates cage extends beyond cone (inner-ring) backface.
 (7) Negative value indicates cage that does not extend beyond cone (inner-ring) front face.
 (*) Contact your Timken engineer for details.

Continued on next page.

TAPERED ROLLER BEARINGS

SINGLE-ROW • TYPE TS

TYPE TS



Bearing Dimensions			Load Ratings							Part Number		
Bore d	O.D. D	Width T	Dynamic ⁽¹⁾		Factors ⁽²⁾		Dynamic ⁽³⁾		Factors ⁽²⁾	Static	Inner	Outer
			C ₁	e	Y	C ₉₀	C _{a90}	K	C ₀			
mm in.	mm in.	mm in.	N lbf			N lbf	N lbf			N lbf		
190.500 7.5000	360.000 14.1732	92.075 3.6250	1170000 263000	0.40	1.49	303000 68100	208000 46800	1.45		1820000 409000	EE420751	421417
190.500 7.5000	365.049 14.3720	92.075 3.6250	1170000 263000	0.40	1.49	303000 68100	208000 46800	1.45		1820000 409000	EE420751	421437
190.500 7.5000	368.300 14.5000	92.075 3.6250	1170000 263000	0.40	1.49	303000 68100	208000 46800	1.45		1820000 409000	EE420751	421450
190.500 7.5000	428.625 16.8750	106.363 4.1875	1640000 370000	0.76	0.79	426000 95900	554000 124000	0.77		1700000 382000	EE350750	351687
192.088 7.5625	266.700 10.5000	47.625 1.8750	416000 93600	0.48	1.26	108000 24300	88200 19800	1.22		835000 188000	67887	67820
193.675 7.6250	282.575 11.1250	50.800 2.0000	509000 114000	0.42	1.44	132000 29700	93900 21100	1.41		692000 156000	87762	87111
196.850 7.7500	257.175 10.1250	39.688 1.5625	318000 71600	0.45	1.34	82500 18600	63100 14200	1.31		718000 161000	LM739749	LM739710
196.850 7.7500	266.700 10.5000	39.688 1.5625	318000 71600	0.45	1.34	82500 18600	63100 14200	1.31		718000 161000	LM739749	LM739719
196.850 7.7500	317.500 12.5000	63.500 2.5000	731000 164000	0.52	1.15	190000 42600	170000 38200	1.12		1290000 290000	93775	93125
200.000 7.8740	300.000 11.8110	65.000 2.5591	695000 156000	0.52	1.15	180000 40500	161000 36200	1.12		1280000 287000	JHM840449	JHM840410
200.025 7.8750	292.100 11.5000	57.945 2.2813	600000 135000	0.33	1.80	156000 35000	88500 19900	1.76		1170000 263000	M241543	M241510
200.025 7.8750	317.500 12.5000	63.500 2.5000	731000 164000	0.52	1.15	190000 42600	170000 38200	1.12		1290000 290000	93787	93125
200.025 7.8750	317.500 12.5000	68.262 2.6875	731000 164000	0.52	1.15	190000 42600	170000 38200	1.12		1290000 290000	93787	93126
200.025 7.8750	320.000 12.5984	63.500 2.5000	731000 164000	0.52	1.15	190000 42600	170000 38200	1.12		1290000 290000	93787	J93129A
200.025 7.8750	355.600 14.0000	69.850 2.7500	796000 179000	0.33	1.82	206000 46400	117000 26200	1.77		1400000 314000	EE130787	131400
200.025 7.8750	384.175 15.1250	112.712 4.4375	1670000 377000	0.33	1.80	434000 97600	247000 55600	1.76		3110000 699000	H247535	H247510
200.025 7.8750	393.700 15.5000	111.125 4.3750	2110000 474000	0.30	2.01	547000 123000	279000 62800	1.96		2600000 585000	HH144642	HH144614

⁽¹⁾Based on 1 x 10⁶ revolutions L₁₀ life, for the ISO life-calculation method.

⁽²⁾Consult your Timken engineer for instructions on use or review the Timken Engineering Manual on timken.com/catalogs.

⁽³⁾Based on 90 x 10⁶ revolutions L₁₀ life, for The Timken Company life-calculation method. C₉₀ and C_{a90} are radial and thrust values.

Bearing Dimensions											Geometry Factors			Bearing Weight
Width B	Width C	Eff. Ctr. a ⁽⁴⁾	Shaft			Housing			Cage		G ₁	G ₂	C _g	
			Max Shaft Fillet Radius R ⁽⁵⁾	Backing Shoulder Dia. d _a	Backing Shoulder Dia. d _b	Max Housing Fillet Radius r ⁽⁵⁾	Backing Shoulder Dia. D _a	Backing Shoulder Dia. D _b	A _a ⁽⁶⁾	A _b ⁽⁷⁾				
mm in.	mm in.	mm in.	mm in.	mm in.	mm in.	mm in.	mm in.	mm in.	mm in.	mm in.				kg lbs.
88.897 3.4999	63.500 2.5000	-15.5 -0.61	6.4 0.25	218.0 8.58	227.0 8.94	3.3 0.13	334.4 13.16	327.0 12.87	19.1 0.75	2.5 0.10	1150.5	128.2	0.1450	38.26 84.34
88.897 3.4999	63.500 2.5000	-15.5 -0.61	6.4 0.25	218.0 8.58	227.0 8.94	3.3 0.13	334.4 13.16	329.0 12.95	19.1 0.75	2.5 0.10	1150.5	128.2	0.1450	39.68 87.48
88.897 3.4999	63.500 2.5000	-15.5 -0.61	6.4 0.25	218.0 8.58	227.0 8.94	3.3 0.13	334.4 13.16	331.0 13.03	19.1 0.75	2.5 0.10	1150.5	128.2	0.1450	40.61 89.53
95.250 3.7500	61.912 2.4375	13.0 0.51	6.4 0.25	237.0 9.33	240.0 9.45	6.4 0.25	383.0 15.08	365.0 14.37	21.1 0.83	16.1 0.64	827.7	77.3	0.1568	62.86 138.59
46.833 1.8438	38.100 1.5000	10.2 0.40	10.5 0.41	204.0 8.03	223.0 8.78	3.3 0.13	259.0 10.20	246.0 9.69	5.0 0.20	1.8 0.08	727.9	146.6	0.1310	7.54 16.63
47.625 1.8750	36.512 1.4375	3.8 0.15	3.5 0.14	206.0 8.11	211.0 8.31	3.3 0.13	267.0 10.50	261.0 10.28	8.7 0.34	2.7 0.11	574.6	130.8	0.1155	9.11 20.08
39.688 1.5625	30.162 1.1875	11.4 0.45	3.5 0.14	206.0 8.11	213.0 8.39	3.3 0.13	251.0 9.88	239.0 9.41	3.4 0.13	2.1 0.09	761.7	232.3	0.1296	5.27 11.62
39.688 1.5625	30.162 1.1875	11.4 0.45	3.5 0.14	206.0 8.11	213.0 8.39	3.3 0.13	252.0 9.92	243.0 9.57	3.4 0.13	2.1 0.09	761.7	232.3	0.1296	6.19 13.66
63.500 2.5000	46.038 1.8125	7.9 0.31	4.3 0.17	216.0 8.50	223.0 8.78	3.3 0.13	300.0 11.81	286.0 11.26	9.1 0.36	4.3 0.17	912.5	126.1	0.1460	18.75 41.34
62.000 2.4409	51.000 2.0079	8.1 0.32	3.5 0.14	215.0 8.46	226.0 8.90	2.5 0.10	288.9 11.37	273.0 10.75	4.8 0.18	6.1 0.24	853.6	126.4	0.1428	15.32 33.78
57.945 2.2813	46.038 1.8125	-4.8 -0.19	3.5 0.14	215.0 8.46	219.0 8.62	3.3 0.13	279.0 10.98	272.0 10.71	4.7 0.18	2.0 0.08	954.1	127.9	0.1279	12.51 27.59
63.500 2.5000	46.038 1.8125	7.9 0.31	4.3 0.17	219.0 8.62	225.0 8.86	3.3 0.13	300.0 11.81	286.0 11.26	9.1 0.36	4.3 0.17	912.5	126.1	0.1460	18.28 40.31
63.500 2.5000	50.800 2.0000	7.9 0.31	4.3 0.17	219.0 8.62	225.0 8.86	3.3 0.13	300.0 11.81	285.0 11.22	9.1 0.36	4.3 0.17	912.5	126.1	0.1460	19.15 42.22
63.500 2.5000	46.038 1.8125	7.9 0.31	4.3 0.17	219.0 8.62	225.0 8.86	3.3 0.13	298.0 11.73	287.0 11.30	9.1 0.36	4.3 0.17	912.5	126.1	0.1460	18.73 41.31
69.850 2.7500	49.212 1.9375	-9.9 -0.39	6.8 0.27	226.0 8.90	236.0 9.29	1.5 0.06	330.4 13.01	329.0 12.95	12.2 0.48	3.3 0.13	1162.0	167.6	0.1358	28.14 62.04
112.712 4.4375	90.488 3.5625	-27.9 -1.10	6.4 0.25	231.0 9.09	241.0 9.49	6.4 0.25	362.5 14.27	346.0 13.62	10.2 0.40	2.9 0.12	1964.4	148.4	0.1638	60.49 133.34
111.125 4.3750	84.138 3.3125	-33.8 -1.33	6.4 0.25	226.0 8.90	235.0 9.25	6.4 0.25	356.6 14.04	352.0 13.86	15.6 0.61	1.5 0.06	1470.9	128.3	0.1429	58.53 129.05

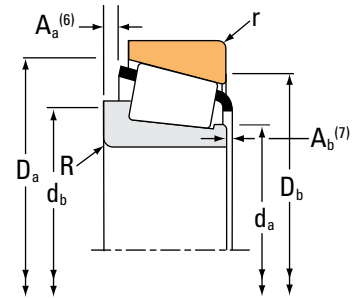
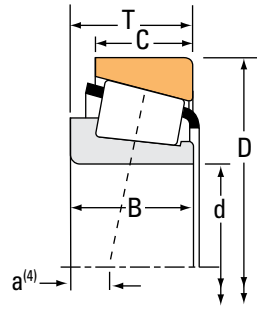
(4) Negative value indicates effective center inside cone (inner-ring) backface.
 (5) These maximum fillet radii will be cleared by the bearing corners.
 (6) Negative value indicates cage extends beyond cone (inner-ring) backface.
 (7) Negative value indicates cage that does not extend beyond cone (inner-ring) front face.

Continued on next page.

TAPERED ROLLER BEARINGS

SINGLE-ROW • TYPE TS

TYPE TS



Bearing Dimensions			Load Ratings							Part Number		
Bore d	O.D. D	Width T	Dynamic ⁽¹⁾		Factors ⁽²⁾		Dynamic ⁽³⁾		Factors ⁽²⁾	Static	Inner	Outer
			C ₁	e	Y	C ₉₀	C _{a90}	K	C ₀			
mm in.	mm in.	mm in.	N lbf			N lbf	N lbf			N lbf		
201.612 7.9375	365.049 14.3720	92.075 3.6250	1170000 263000	0.40	1.49	303000 68100	208000 46800	1.45		1820000 409000	EE420793	421437
201.612 7.9375	368.300 14.5000	92.075 3.6250	1170000 263000	0.40	1.49	303000 68100	208000 46800	1.45		1820000 409000	EE420793	421450
203.200 8.0000	261.142 10.2812	28.575 1.1250	208000 46700	0.41	1.47	53900 12100	37700 8480	1.43		405000 91100	LL641149	LL641110
203.200 8.0000	276.225 10.8750	42.862 1.6875	439000 98700	0.32	1.88	114000 25600	62100 14000	1.83		811000 182000	LM241149	LM241110
203.200 8.0000	282.575 11.1250	46.038 1.8125	503000 113000	0.51	1.18	130000 29300	114000 25500	1.15		876000 197000	67983	67920
203.200 8.0000	292.100 11.5000	57.945 2.2813	600000 135000	0.33	1.80	156000 35000	88500 19900	1.76		1170000 263000	M241547	M241510
203.200 8.0000	292.100 11.5000	57.945 2.2813	688000 155000	0.33	1.80	178000 40100	102000 22800	1.76		1170000 263000	M241547C	M241510
203.200 8.0000	317.500 12.5000	53.975 2.1250	559000 126000	0.31	1.91	145000 32600	77800 17500	1.86		900000 202000	EE132083	132125
203.200 8.0000	317.500 12.5000	63.500 2.5000	731000 164000	0.52	1.15	190000 42600	170000 38200	1.12		1290000 290000	93800A	93125
203.200 8.0000	317.500 12.5000	63.500 2.5000	731000 164000	0.52	1.15	190000 42600	170000 38200	1.12		1290000 290000	93800	93125
203.200 8.0000	360.000 14.1732	92.075 3.6250	1170000 263000	0.40	1.49	303000 68100	208000 46800	1.45		1820000 409000	EE420801	421417
203.200 8.0000	365.049 14.3720	92.075 3.6250	1170000 263000	0.40	1.49	303000 68100	208000 46800	1.45		1820000 409000	EE420801	421437
203.200 8.0000	368.300 14.5000	92.075 3.6250	1170000 263000	0.40	1.49	303000 68100	208000 46800	1.45		1820000 409000	EE420801	421450
203.200 8.0000	406.400 16.0000	92.075 3.6250	1220000 274000	0.80	0.75	316000 71000	431000 97000	0.73		1460000 328000	EE114080	114160
203.200 8.0000	482.600 19.0000	117.475 4.6250	1650000 371000	0.87	0.69	428000 96200	635000 143000	0.67		2010000 453000	EE380080	380190
203.238 8.0015	406.400 16.0000	92.075 3.6250	1220000 274000	0.80	0.75	316000 71000	431000 97000	0.73		1460000 328000	EE114081	114160
204.788 8.0625	292.100 11.5000	57.945 2.2813	600000 135000	0.33	1.80	156000 35000	88500 19900	1.76		1170000 263000	M241549	M241510

⁽¹⁾Based on 1 x 10⁶ revolutions L₁₀ life, for the ISO life-calculation method.

⁽²⁾Consult your Timken engineer for instructions on use or review the Timken Engineering Manual on timken.com/catalogs.

⁽³⁾Based on 90 x 10⁶ revolutions L₁₀ life, for The Timken Company life-calculation method. C₉₀ and C_{a90} are radial and thrust values.

Bearing Dimensions											Geometry Factors			Bearing Weight
Width B	Width C	Eff. Ctr. a ⁽⁴⁾	Shaft			Housing			Cage		G ₁	G ₂	C _g	
			Max Shaft Fillet Radius R ⁽⁵⁾	Backing Shoulder Dia. d _a	mm in.	Max Housing Fillet Radius r ⁽⁵⁾	Backing Shoulder Dia. D _a	mm in.	A _a ⁽⁶⁾	A _b ⁽⁷⁾				
mm in.	mm in.	mm in.	mm in.	mm in.	mm in.	mm in.	mm in.	mm in.	mm in.	mm in.			kg lbs.	
88.897 3.4999	63.500 2.5000	-15.5 -0.61	3.3 0.13	226.0 8.90	229.0 9.02	3.3 0.13	334.4 13.16	329.0 12.95	19.1 0.75	2.5 0.10	1150.5	128.2	0.1450	37.37 82.39
88.897 3.4999	63.500 2.5000	-15.5 -0.61	3.3 0.13	226.0 8.90	229.0 9.02	3.3 0.13	334.4 13.16	331.0 13.03	19.1 0.75	2.5 0.10	1150.5	128.2	0.1450	38.30 84.44
27.783 1.0938	21.433 0.8438	15.7 0.62	1.5 0.06	212.0 8.35	214.0 8.43	1.5 0.06	254.0 10.00	249.0 9.80	3.1 0.12	1.7 0.07	521.9	231.1	0.1398	3.48 7.66
42.862 1.6875	34.133 1.3438	1.8 0.07	3.5 0.14	214.1 8.43	220.0 8.66	3.3 0.13	267.0 10.51	260.0 10.24	2.8 0.11	1.4 0.06	774.0	182.2	0.1170	7.02 15.48
46.038 1.8125	36.512 1.4375	16.0 0.63	3.5 0.14	216.0 8.50	222.0 8.74	3.3 0.13	275.0 10.83	260.0 10.24	4.4 0.17	1.7 0.07	819.5	172.0	0.1388	8.65 19.09
57.945 2.2813	46.038 1.8125	-4.8 -0.19	3.5 0.14	217.0 8.54	221.0 8.70	3.3 0.13	279.0 10.98	272.0 10.71	4.7 0.18	2.0 0.08	954.1	127.9	0.1279	12.06 26.58
57.945 2.2813	46.038 1.8125	-4.8 -0.19	3.5 0.14	217.0 8.54	221.0 8.70	3.3 0.13	279.0 10.98	272.0 10.71	4.7 0.18	2.0 0.08	954.1	127.9	0.1279	12.04 26.54
53.975 2.1250	34.925 1.3750	-6.1 -0.24	4.0 0.16	217.9 8.58	225.0 8.86	3.3 0.13	293.1 11.54	293.9 11.57	10.7 0.42	3.2 0.13	797.8	124.6	0.1174	13.87 30.57
63.500 2.5000	46.038 1.8125	7.9 0.31	8.0 0.31	222.0 8.74	234.0 9.21	3.3 0.13	300.0 11.81	286.0 11.26	9.1 0.36	4.3 0.17	912.5	126.1	0.1460	17.64 38.90
63.500 2.5000	46.038 1.8125	7.9 0.31	4.3 0.17	222.0 8.74	227.0 8.94	3.3 0.13	300.0 11.81	286.0 11.26	9.1 0.36	4.3 0.17	912.5	126.1	0.1460	17.78 39.21
88.897 3.4999	63.500 2.5000	-15.5 -0.61	3.3 0.13	227.1 8.94	230.1 9.06	3.3 0.13	334.4 13.16	327.0 12.87	19.1 0.75	2.5 0.10	1150.5	128.2	0.1450	35.60 78.47
88.897 3.4999	63.500 2.5000	-15.5 -0.61	3.3 0.13	227.1 8.94	230.1 9.06	3.3 0.13	334.4 13.16	329.0 12.95	19.1 0.75	2.5 0.10	1150.5	128.2	0.1450	37.02 81.62
88.897 3.4999	63.500 2.5000	-15.5 -0.61	3.3 0.13	227.1 8.94	230.1 9.06	3.3 0.13	334.4 13.16	331.0 13.03	19.1 0.75	2.5 0.10	1150.5	128.2	0.1450	37.95 83.67
85.725 3.3750	57.150 2.2500	24.9 0.98	6.4 0.25	237.0 9.33	246.0 9.69	6.4 0.25	373.7 14.71	349.0 13.74	19.0 0.74	10.7 0.42	794.7	80.2	0.1571	46.85 103.29
95.250 3.7500	73.025 2.8750	34.3 1.35	6.4 0.25	274.0 10.79	280.0 11.02	6.4 0.25	428.5 16.87	402.0 15.83	22.2 0.87	17.0 0.67	1105.0	103.8	0.1792	91.88 202.54
85.725 3.3750	57.150 2.2500	24.9 0.98	6.4 0.25	237.0 9.33	246.0 9.69	6.4 0.25	373.7 14.71	349.0 13.74	19.0 0.74	10.7 0.42	794.7	80.2	0.1571	46.85 103.29
57.945 2.2813	46.038 1.8125	-4.8 -0.19	3.5 0.14	219.0 8.62	223.0 8.78	3.3 0.13	279.0 10.98	272.0 10.71	4.7 0.18	2.0 0.08	954.1	127.9	0.1279	11.83 26.08

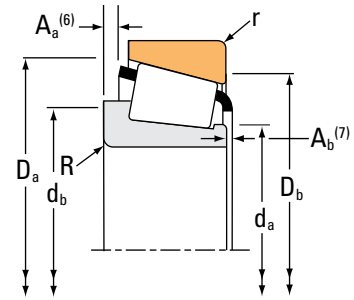
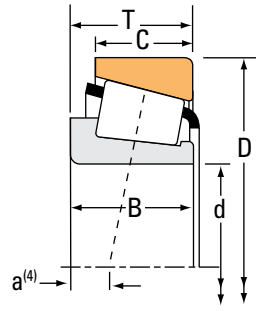
(4) Negative value indicates effective center inside cone (inner-ring) backface.
 (5) These maximum fillet radii will be cleared by the bearing corners.
 (6) Negative value indicates cage extends beyond cone (inner-ring) backface.
 (7) Negative value indicates cage that does not extend beyond cone (inner-ring) front face.

Continued on next page.

TAPERED ROLLER BEARINGS

SINGLE-ROW • TYPE TS

TYPE TS



Bearing Dimensions			Load Ratings							Part Number		
Bore d	O.D. D	Width T	Dynamic ⁽¹⁾		Factors ⁽²⁾		Dynamic ⁽³⁾		Factors ⁽²⁾	Static	Inner	Outer
			C ₁	e	Y	C ₉₀	C _{a90}	K	C ₀			
mm in.	mm in.	mm in.	N lbf			N lbf	N lbf			N lbf		
204.788 8.0625	317.500 12.5000	63.500 2.5000	731000 164000	0.52	1.15	190000 42600	170000 38200	1.12		1290000 290000	93806A	93125
206.375 8.1250	261.142 10.2812	28.575 1.1250	196000 44100	0.41	1.47	50900 11400	35600 8010	1.43		405000 91100	LL641149A	LL641110
206.375 8.1250	282.575 11.1250	46.038 1.8125	503000 113000	0.51	1.18	130000 29300	114000 25500	1.15		876000 197000	67985	67920
206.375 8.1250	317.500 12.5000	53.975 2.1250	528000 119000	0.31	1.91	137000 30800	73400 16500	1.86		900000 202000	EE132084	132125
206.375 8.1250	317.500 12.5000	63.500 2.5000	731000 164000	0.52	1.15	190000 42600	170000 38200	1.12		1290000 290000	93812	93125
206.375 8.1250	336.550 13.2500	98.425 3.8750	1350000 305000	0.33	1.80	351000 79000	200000 45000	1.76		2320000 522000	H242649	H242610
206.375 8.1250	360.000 14.1732	92.075 3.6250	1100000 248000	0.40	1.49	286000 64300	197000 44200	1.45		1820000 409000	EE420812X	421417
206.375 8.1250	482.600 19.0000	117.475 4.6250	1650000 371000	0.87	0.69	428000 96200	635000 143000	0.67		2010000 453000	EE380081	380190
209.550 8.2500	279.400 11.0000	46.038 1.8125	503000 113000	0.51	1.18	130000 29300	114000 25500	1.15		876000 197000	67989	67919
209.550 8.2500	282.575 11.1250	46.038 1.8125	503000 113000	0.51	1.18	130000 29300	114000 25500	1.15		876000 197000	67989	67920
209.550 8.2500	317.500 12.5000	63.500 2.5000	731000 164000	0.52	1.15	190000 42600	170000 38200	1.12		1290000 290000	93825	93125
209.550 8.2500	317.500 12.5000	63.500 2.5000	731000 164000	0.52	1.15	190000 42600	170000 38200	1.12		1290000 290000	93825A	93125
209.550 8.2500	317.500 12.5000	68.262 2.6875	731000 164000	0.52	1.15	190000 42600	170000 38200	1.12		1290000 290000	93825	93126
209.550 8.2500	355.600 14.0000	68.262 2.6875	759000 171000	0.59	1.02	197000 44200	199000 44700	0.99		1420000 319000	96825	96140
212.725 8.3750	285.750 11.2500	46.038 1.8125	430000 96600	0.48	1.25	111000 25000	91800 20600	1.21		892000 200000	LM742745	LM742710
212.725 8.3750	336.550 13.2500	65.088 2.5625	789000 177000	0.33	1.80	204000 46000	116000 26200	1.76		1570000 352000	M246932	M246910
215.900 8.5000	285.750 11.2500	46.038 1.8125	430000 96600	0.48	1.25	111000 25000	91800 20600	1.21		892000 200000	LM742749	LM742710

⁽¹⁾Based on 1 x 10⁶ revolutions L₁₀ life, for the ISO life-calculation method.

⁽²⁾Consult your Timken engineer for instructions on use or review the Timken Engineering Manual on timken.com/catalogs.

⁽³⁾Based on 90 x 10⁶ revolutions L₁₀ life, for The Timken Company life-calculation method. C₉₀ and C_{a90} are radial and thrust values.

Bearing Dimensions											Geometry Factors			Bearing Weight
Width B	Width C	Eff. Ctr. a ⁽⁴⁾	Shaft			Housing			Cage		G ₁	G ₂	C _g	
			Max Shaft Fillet Radius R ⁽⁵⁾	Backing Shoulder Dia. d _a	Backing Shoulder Dia. d _b	Max Housing Fillet Radius r ⁽⁵⁾	Backing Shoulder Dia. D _a	Backing Shoulder Dia. D _b	A _a ⁽⁶⁾	A _b ⁽⁷⁾				
mm in.	mm in.	mm in.	mm in.	mm in.	mm in.	mm in.	mm in.	mm in.	mm in.	mm in.				kg lbs.
63.500 2.5000	46.038 1.8125	7.9 0.31	4.3 0.17	223.0 8.78	229.0 9.02	3.3 0.13	300.0 11.81	286.0 11.26	9.1 0.36	4.3 0.17	912.5	126.1	0.1460	17.50 38.60
27.783 1.0938	21.433 0.8438	15.7 0.62	1.5 0.06	212.0 8.35	214.0 8.43	1.5 0.06	254.0 10.00	249.0 9.80	3.1 0.12	1.7 0.07	521.9	231.1	0.1398	3.27 7.21
46.038 1.8125	36.512 1.4375	16.0 0.63	3.5 0.14	219.0 8.62	224.0 8.82	3.3 0.13	275.0 10.83	260.0 10.24	4.4 0.17	1.7 0.07	819.5	172.0	0.1388	8.28 18.28
53.975 2.1250	34.925 1.3750	-6.1 -0.24	4.0 0.16	220.0 8.66	227.1 8.94	3.3 0.13	293.1 11.54	293.9 11.57	10.7 0.42	3.2 0.13	797.8	124.6	0.1174	13.44 29.62
63.500 2.5000	46.038 1.8125	7.9 0.31	4.3 0.17	224.0 8.82	230.0 9.06	3.3 0.13	300.0 11.81	286.0 11.26	9.1 0.36	4.3 0.17	912.5	126.1	0.1460	17.25 38.03
100.012 3.9375	77.788 3.0625	-25.4 -1.00	3.3 0.13	227.0 8.94	231.0 9.09	3.3 0.13	318.0 12.51	306.0 12.05	11.1 0.44	1.9 0.08	1404.1	134.8	0.1465	33.19 73.17
88.897 3.4999	63.500 2.5000	-15.5 -0.61	6.4 0.25	229.0 9.02	239.0 9.41	3.3 0.13	334.4 13.16	327.0 12.87	19.1 0.75	2.5 0.10	1150.5	128.2	0.1450	34.81 76.74
95.250 3.7500	73.025 2.8750	34.3 1.35	6.4 0.25	258.0 10.16	264.0 10.39	6.4 0.25	428.5 16.87	402.0 15.83	22.2 0.87	17.3 0.68	1105.0	103.8	0.1792	91.19 201.03
46.038 1.8125	36.512 1.4375	16.0 0.63	3.5 0.14	221.0 8.70	227.0 8.94	3.3 0.13	273.0 10.75	259.0 10.20	4.4 0.17	1.7 0.07	819.5	172.0	0.1388	7.52 16.58
46.038 1.8125	36.512 1.4375	16.0 0.63	3.5 0.14	221.0 8.70	227.0 8.94	3.3 0.13	275.0 10.83	260.0 10.24	4.4 0.17	1.7 0.07	819.5	172.0	0.1388	7.91 17.45
63.500 2.5000	46.038 1.8125	7.9 0.31	4.3 0.17	226.9 8.93	233.0 9.17	3.3 0.13	300.0 11.81	286.0 11.26	9.1 0.36	4.3 0.17	912.5	126.1	0.1460	16.76 36.96
63.500 2.5000	46.038 1.8125	7.9 0.31	12.7 0.50	226.9 8.93	250.0 9.84	3.3 0.13	300.0 11.81	286.0 11.26	9.1 0.36	4.3 0.17	912.5	126.1	0.1460	16.60 36.60
63.500 2.5000	50.800 2.0000	7.9 0.31	4.3 0.17	226.9 8.93	233.0 9.17	3.3 0.13	300.0 11.81	285.0 11.22	9.1 0.36	4.3 0.17	912.5	126.1	0.1460	17.63 38.86
66.675 2.6250	47.625 1.8750	17.0 0.67	7.0 0.28	235.0 9.25	246.0 9.69	3.3 0.13	334.0 13.15	318.0 12.52	11.9 0.47	3.8 0.15	1140.0	160.6	0.1626	26.70 58.88
46.038 1.8125	34.925 1.3750	14.2 0.56	3.5 0.14	225.0 8.86	230.0 9.06	3.3 0.13	279.0 10.98	266.0 10.47	5.1 0.20	2.0 0.08	866.9	225.2	0.1388	7.97 17.57
65.088 2.5625	50.800 2.0000	-4.8 -0.19	6.4 0.25	235.0 9.25	244.0 9.61	3.3 0.13	322.0 12.68	313.0 12.32	5.1 0.20	3.3 0.13	1354.6	198.0	0.1436	21.86 48.17
46.038 1.8125	34.925 1.3750	14.2 0.56	3.5 0.14	227.0 8.94	233.0 9.17	3.3 0.13	279.0 10.98	266.0 10.47	5.1 0.20	2.0 0.08	866.9	225.2	0.1388	7.59 16.72

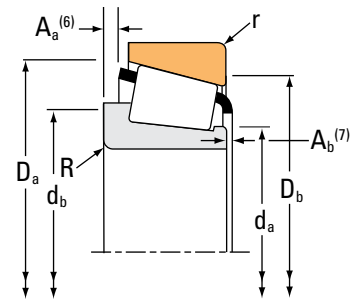
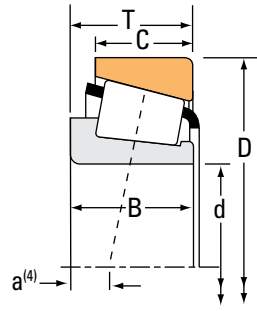
⁽⁴⁾Negative value indicates effective center inside cone (inner-ring) backface.
⁽⁵⁾These maximum fillet radii will be cleared by the bearing corners.
⁽⁶⁾Negative value indicates cage extends beyond cone (inner-ring) backface.
⁽⁷⁾Negative value indicates cage that does not extend beyond cone (inner-ring) front face.

Continued on next page.

TAPERED ROLLER BEARINGS

SINGLE-ROW • TYPE TS

TYPE TS



Bearing Dimensions			Load Ratings							Part Number	
Bore d	O.D. D	Width T	Dynamic ⁽¹⁾ C ₁	Factors ⁽²⁾ e	Y	Dynamic ⁽³⁾ C ₉₀	C _{a90}	Factors ⁽²⁾ K	Static C ₀	Inner	Outer
mm in.	mm in.	mm in.	N lbf			N lbf	N lbf		N lbf		
215.900 8.5000	285.750 11.2500	46.038 1.8125	430000 96600	0.48	1.25	111000 25000	91800 20600	1.21	892000 200000	LM742749AA	LM742710
215.900 8.5000	288.925 11.3750	46.038 1.8125	430000 96600	0.48	1.25	111000 25000	91800 20600	1.21	892000 200000	LM742749	LM742714
215.900 8.5000	290.010 11.4177	31.750 1.2500	239000 53800	0.39	1.56	62000 13900	40900 9190	1.52	453000 102000	543085	543114
215.900 8.5000	355.600 14.0000	69.850 2.7500	796000 179000	0.33	1.82	206000 46400	117000 26200	1.77	1400000 314000	EE130851	131400
215.900 8.5000	360.000 14.1732	82.550 3.2500	1100000 248000	0.40	1.49	286000 64300	197000 44200	1.45	1820000 409000	EE420850	421417
215.900 8.5000	365.049 14.3720	82.550 3.2500	1100000 248000	0.40	1.49	286000 64300	197000 44200	1.45	1820000 409000	EE420850	421437
219.969 8.6602	290.010 11.4177	31.750 1.2500	239000 53800	0.39	1.56	62000 13900	40900 9190	1.52	453000 102000	543086	543114
219.969 8.6602	292.009 11.4964	31.750 1.2500	239000 53800	0.39	1.56	62000 13900	40900 9190	1.52	453000 102000	543086	543116
219.975 8.6604	384.175 15.1250	112.712 4.4375	1920000 432000	0.33	1.80	498000 112000	284000 63700	1.76	3110000 699000	H247540	H247510
220.662 8.6875	314.325 12.3750	61.912 2.4375	695000 156000	0.33	1.80	180000 40500	103000 23100	1.76	1370000 308000	M244249	M244210
220.662 8.6875	314.325 12.3750	61.912 2.4375	649000 146000	0.33	1.80	168000 37800	95800 21500	1.76	1240000 279000	M244249A	M244210
222.250 8.7500	482.600 19.0000	117.475 4.6250	1650000 371000	0.87	0.69	428000 96200	635000 143000	0.67	2010000 453000	EE380875	380190
223.838 8.8125	295.275 11.6250	46.038 1.8125	516000 116000	0.50	1.20	134000 30100	114000 25700	1.17	919000 207000	LM844049	LM844010
225.425 8.8750	355.600 14.0000	69.850 2.7500	796000 179000	0.33	1.82	206000 46400	117000 26200	1.77	1400000 314000	EE130889	131400
225.425 8.8750	400.050 15.7500	88.900 3.5000	1120000 253000	0.44	1.36	291000 65500	219000 49300	1.33	1920000 432000	EE430888	431575
227.330 8.9500	406.400 16.0000	63.500 2.5000	955000 215000	0.47	1.27	248000 55600	200000 45000	1.24	1280000 287000	EE710905	711600
228.397 8.9920	431.800 17.0000	92.075 3.6250	1270000 287000	0.88	0.68	330000 74300	500000 112000	0.66	1600000 361000	EE113089	113170

⁽¹⁾Based on 1 x 10⁶ revolutions L₁₀ life, for the ISO life-calculation method.

⁽²⁾Consult your Timken engineer for instructions on use or review the Timken Engineering Manual on timken.com/catalogs.

⁽³⁾Based on 90 x 10⁶ revolutions L₁₀ life, for The Timken Company life-calculation method. C₉₀ and C_{a90} are radial and thrust values.

Bearing Dimensions											Geometry Factors			Bearing Weight
Width B	Width C	Eff. Ctr. a ⁽⁴⁾	Shaft			Housing			Cage		G ₁	G ₂	C _g	
			Max Shaft Fillet Radius R ⁽⁵⁾	Backing Shoulder Dia. d _a	Backing Shoulder Dia. d _b	Max Housing Fillet Radius r ⁽⁵⁾	Backing Shoulder Dia. D _a	Backing Shoulder Dia. D _b	A _a ⁽⁶⁾	A _b ⁽⁷⁾				
mm in.	mm in.	mm in.	mm in.	mm in.	mm in.	mm in.	mm in.	mm in.	mm in.	mm in.				kg lbs.
46.038 1.8125	34.925 1.3750	14.2 0.56	8.9 0.35	227.0 8.94	242.0 9.57	3.3 0.13	279.0 10.98	266.0 10.47	5.1 0.20	2.0 0.08	866.9	225.2	0.1388	7.51 16.55
46.038 1.8125	34.925 1.3750	14.2 0.56	3.5 0.14	227.0 8.94	233.0 9.17	3.3 0.13	280.0 11.02	267.0 10.51	5.1 0.20	2.0 0.08	866.9	225.2	0.1388	7.95 17.52
31.750 1.2500	22.225 0.8750	13.0 0.51	3.5 0.14	226.0 8.90	232.0 9.13	3.3 0.13	276.0 10.87	272.0 10.71	4.1 0.16	2.8 0.11	608.5	232.3	0.1135	5.42 11.96
69.850 2.7500	49.212 1.9375	-9.9 -0.39	6.8 0.27	237.0 9.33	248.0 9.76	1.5 0.06	330.4 13.01	329.0 12.95	12.2 0.48	3.3 0.13	1162.0	167.6	0.1358	25.30 55.78
79.372 3.1249	63.500 2.5000	-6.1 -0.24	1.5 0.06	236.0 9.29	236.0 9.29	3.3 0.13	334.4 13.16	327.0 12.87	9.6 0.37	2.5 0.10	1150.5	128.2	0.1450	30.88 68.06
79.372 3.1249	63.500 2.5000	-6.1 -0.24	1.5 0.06	236.0 9.29	236.0 9.29	3.3 0.13	334.4 13.16	329.0 12.95	9.6 0.37	2.5 0.10	1150.5	128.2	0.1450	32.30 71.21
31.750 1.2500	22.225 0.8750	13.0 0.51	3.5 0.14	229.0 9.02	235.0 9.25	3.3 0.13	276.0 10.87	272.0 10.71	4.1 0.16	2.8 0.11	608.5	232.3	0.1135	5.08 11.20
31.750 1.2500	22.225 0.8750	13.0 0.51	3.5 0.14	229.0 9.02	235.0 9.25	3.3 0.13	276.0 10.87	273.0 10.75	4.1 0.16	2.8 0.11	608.5	232.3	0.1135	5.21 11.49
112.712 4.4375	90.488 3.5625	-27.9 -1.10	6.4 0.25	259.0 10.20	269.0 10.59	6.4 0.25	362.5 14.27	346.0 13.62	10.2 0.40	2.9 0.12	1964.4	148.4	0.1638	54.81 120.81
61.912 2.4375	49.212 1.9375	-4.6 -0.18	6.4 0.25	235.0 9.25	245.0 9.65	3.3 0.13	300.0 11.81	293.0 11.54	4.9 0.19	2.5 0.10	1149.7	141.4	0.1360	14.52 32.03
66.675 2.6250	49.212 1.9375	-4.6 -0.18	1.5 0.06	235.0 9.25	235.0 9.25	3.3 0.13	300.0 11.81	293.0 11.54	3.2 0.12	0.4 0.02	1073.1	132.4	0.1327	14.91 32.89
95.250 3.7500	73.025 2.8750	34.3 1.35	6.4 0.25	267.0 10.51	277.0 10.91	6.4 0.25	428.5 16.87	402.0 15.83	22.2 0.87	17.3 0.68	1105.0	103.8	0.1792	87.21 192.25
46.038 1.8125	34.925 1.3750	17.0 0.67	3.5 0.14	235.0 9.25	241.0 9.49	3.3 0.13	288.0 11.34	275.0 10.83	5.2 0.20	2.0 0.08	927.3	268.8	0.1434	8.02 17.69
69.850 2.7500	49.212 1.9375	-9.9 -0.39	6.8 0.27	244.0 9.61	255.0 10.04	1.5 0.06	330.4 13.01	329.0 12.95	12.2 0.48	3.3 0.13	1162.0	167.6	0.1358	22.94 50.59
87.312 3.4375	63.500 2.5000	-4.8 -0.19	1.5 0.06	251.0 9.88	251.0 9.88	3.3 0.13	364.2 14.34	360.0 14.17	14.8 0.58	1.5 0.06	1351.2	142.8	0.1572	43.79 96.54
61.912 2.4375	39.688 1.5625	12.2 0.48	7.0 0.28	248.9 9.80	261.9 10.31	6.4 0.25	372.1 14.65	368.0 14.49	9.4 0.37	7.4 0.29	914.9	114.2	0.1402	31.26 68.91
85.725 3.3750	49.212 1.9375	41.4 1.63	6.4 0.25	267.0 10.51	274.0 10.79	6.4 0.25	397.2 15.64	375.0 14.76	19.4 0.76	11.5 0.46	966.7	98.1	0.1723	51.03 112.50

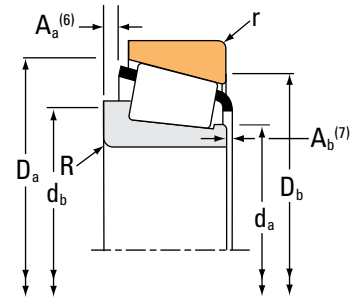
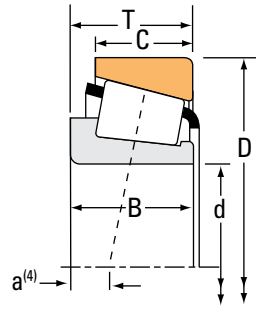
(4) Negative value indicates effective center inside cone (inner-ring) backface.
 (5) These maximum fillet radii will be cleared by the bearing corners.
 (6) Negative value indicates cage extends beyond cone (inner-ring) backface.
 (7) Negative value indicates cage that does not extend beyond cone (inner-ring) front face.

Continued on next page.

TAPERED ROLLER BEARINGS

SINGLE-ROW • TYPE TS

TYPE TS



Bearing Dimensions			Load Ratings							Part Number		
Bore d	O.D. D	Width T	Dynamic ⁽¹⁾		Factors ⁽²⁾		Dynamic ⁽³⁾		Factors ⁽²⁾	Static	Inner	Outer
			C ₁	e	Y	C ₉₀	C _{a90}	K	C ₀			
mm in.	mm in.	mm in.	N lbf			N lbf	N lbf			N lbf		
228.460 8.9945	431.800 17.0000	92.075 3.6250	1270000 287000	0.88	0.68	330000 74300	500000 112000	0.66	1600000 361000	EE113091	113170	
228.600 9.0000	295.275 11.6250	33.338 1.3125	238000 53400	0.40	1.49	61600 13900	42400 9530	1.45	458000 103000	544090	544116	
228.600 9.0000	300.038 11.8125	33.338 1.3125	238000 53400	0.40	1.49	61600 13900	42400 9530	1.45	458000 103000	544090	544118	
228.600 9.0000	320.675 12.6250	50.800 2.0000	552000 124000	0.49	1.23	143000 32200	119000 26800	1.20	821000 185000	88900	88126	
228.600 9.0000	327.025 12.8750	52.388 2.0625	552000 124000	0.49	1.23	143000 32200	119000 26800	1.20	821000 185000	88900	88128	
228.600 9.0000	327.025 12.8750	52.388 2.0625	558000 126000	0.41	1.48	145000 32500	101000 22700	1.44	1070000 240000	8573	8520	
228.600 9.0000	355.600 14.0000	68.262 2.6875	759000 171000	0.59	1.02	197000 44200	199000 44700	0.99	1420000 319000	96900	96140	
228.600 9.0000	355.600 14.0000	69.850 2.7500	843000 190000	0.33	1.82	219000 49100	124000 27800	1.77	1400000 314000	EE130902	131400	
228.600 9.0000	355.600 14.0000	69.850 2.7500	951000 214000	0.47	1.27	247000 55400	200000 44900	1.24	1690000 380000	HM746646	HM746610	
228.600 9.0000	358.775 14.1250	71.438 2.8125	914000 206000	0.33	1.80	237000 53300	135000 30300	1.76	1850000 416000	M249732	M249710	
228.600 9.0000	400.050 15.7500	88.900 3.5000	1120000 253000	0.44	1.36	291000 65500	219000 49300	1.33	1920000 432000	EE430900	431575	
228.600 9.0000	406.400 16.0000	63.500 2.5000	955000 215000	0.47	1.27	248000 55600	200000 45000	1.24	1280000 287000	EE710906	711600	
228.600 9.0000	425.450 16.7500	101.600 4.0000	1700000 382000	0.33	1.80	440000 99000	251000 56400	1.76	2140000 481000	EE700091	700167	
228.600 9.0000	488.950 19.2500	123.825 4.8750	2240000 505000	0.94	0.64	582000 131000	934000 210000	0.62	2510000 564000	HH949549	HH949510	
228.600 9.0000	508.000 20.0000	117.475 4.6250	1680000 377000	0.94	0.64	434000 97700	697000 157000	0.62	2100000 473000	EE390090	390200	
231.775 9.1250	358.775 14.1250	71.438 2.8125	914000 206000	0.33	1.80	237000 53300	135000 30300	1.76	1850000 416000	M249734	M249710	
231.775 9.1250	268.288 10.5625	22.500 0.8858	146000 32900	0.33	1.80	37900 8520	21600 4850	1.76	349000 78500	LL244549	LL244510	

⁽¹⁾Based on 1 x 10⁶ revolutions L₁₀ life, for the ISO life-calculation method.

⁽²⁾Consult your Timken engineer for instructions on use or review the Timken Engineering Manual on timken.com/catalogs.

⁽³⁾Based on 90 x 10⁶ revolutions L₁₀ life, for The Timken Company life-calculation method. C₉₀ and C_{a90} are radial and thrust values.

Bearing Dimensions											Geometry Factors			Bearing Weight
Width B	Width C	Eff. Ctr. a ⁽⁴⁾	Shaft			Housing			Cage		G ₁	G ₂	C _g	
			Max Shaft Fillet Radius R ⁽⁵⁾	Backing Shoulder Dia. d _a	Backing Shoulder Dia. d _b	Max Housing Fillet Radius r ⁽⁵⁾	Backing Shoulder Dia. D _a	Backing Shoulder Dia. D _b	A _a ⁽⁶⁾	A _b ⁽⁷⁾				
mm in.	mm in.	mm in.	mm in.	mm in.	mm in.	mm in.	mm in.	mm in.	mm in.	mm in.				kg lbs.
85.725 3.3750	49.212 1.9375	41.4 1.63	6.4 0.25	267.0 10.51	274.0 10.79	6.4 0.25	397.2 15.64	375.0 14.76	19.4 0.76	11.5 0.46	966.7	98.1	0.1723	50.09 110.43
31.750 1.2500	23.812 0.9375	15.7 0.62	3.5 0.14	240.0 9.45	244.0 9.61	3.3 0.13	287.0 11.30	280.0 11.02	4.2 0.16	2.8 0.11	648.6	279.2	0.1174	5.14 11.32
31.750 1.2500	23.812 0.9375	15.7 0.62	3.5 0.14	240.0 9.45	244.0 9.61	3.3 0.13	287.0 11.30	282.0 11.10	4.2 0.16	2.8 0.11	648.6	279.2	0.1174	5.53 12.17
49.212 1.9375	33.338 1.3125	14.2 0.56	6.4 0.25	242.0 9.53	253.0 9.96	3.3 0.13	309.0 12.17	299.0 11.77	11.1 0.43	2.7 0.11	800.1	189.1	0.1352	11.02 24.28
49.212 1.9375	34.925 1.3750	14.2 0.56	6.4 0.25	242.0 9.53	253.0 9.96	3.3 0.13	309.0 12.17	302.0 11.89	11.1 0.43	2.7 0.11	800.1	189.1	0.1352	12.09 26.65
52.388 2.0625	36.512 1.4375	7.6 0.30	6.4 0.25	244.0 9.61	255.0 10.04	3.3 0.13	313.0 12.32	305.0 12.01	7.0 0.27	2.2 0.09	1050.5	172.4	0.1401	13.27 29.26
66.675 2.6250	47.625 1.8750	17.0 0.67	7.0 0.28	249.0 9.80	260.0 10.24	3.3 0.13	334.0 13.15	318.0 12.52	11.9 0.47	3.8 0.15	1140.0	160.6	0.1626	23.36 51.51
69.850 2.7500	49.212 1.9375	-9.9 -0.39	6.8 0.27	247.0 9.72	257.0 10.12	1.5 0.06	330.4 13.01	329.0 12.95	12.2 0.48	3.3 0.13	1162.0	167.6	0.1358	22.87 50.42
69.850 2.7500	50.800 2.0000	6.9 0.27	6.4 0.25	248.0 9.76	258.0 10.16	6.4 0.25	338.7 13.34	324.0 12.76	6.1 0.24	4.5 0.18	1185.7	149.4	0.1542	26.30 57.99
71.438 2.8125	53.975 2.1250	-6.9 -0.27	3.5 0.14	251.0 9.88	256.0 10.08	3.3 0.13	343.0 13.50	335.0 13.19	8.0 0.31	3.1 0.12	1626.0	173.0	0.1526	26.77 59.03
87.312 3.4375	63.500 2.5000	-4.8 -0.19	10.5 0.41	253.0 9.96	271.0 10.67	3.3 0.13	364.2 14.34	360.0 14.17	14.8 0.58	1.5 0.06	1351.2	142.8	0.1572	42.71 94.16
61.912 2.4375	39.688 1.5625	12.2 0.48	7.0 0.28	249.9 9.84	262.9 10.35	6.4 0.25	372.1 14.65	368.0 14.49	9.4 0.37	7.4 0.29	914.9	114.2	0.1402	31.04 68.42
95.250 3.7500	76.200 3.0000	-21.1 -0.83	7.0 0.28	259.0 10.20	266.0 10.47	6.4 0.25	384.0 15.12	381.0 15.00	20.8 0.81	1.1 0.05	1488.7	109.7	0.1480	56.57 124.72
111.125 4.3750	73.025 2.8750	39.9 1.57	6.4 0.25	280.0 11.02	297.0 11.69	6.4 0.25	456.0 17.95	416.0 16.38	21.4 0.84	11.8 0.47	1295.5	91.5	0.1931	98.91 218.07
95.250 3.7500	73.025 2.8750	49.5 1.95	6.4 0.25	277.0 10.91	287.0 11.30	6.4 0.25	456.2 17.96	423.0 16.65	22.4 0.88	19.2 0.76	1258.2	106.2	0.1909	98.28 216.68
71.438 2.8125	53.975 2.1250	-6.9 -0.27	6.4 0.25	254.0 10.00	263.0 10.35	3.3 0.13	343.0 13.50	335.0 13.19	8.0 0.31	3.1 0.12	1626.0	173.0	0.1526	26.05 57.44
21.500 0.8465	18.500 0.7283	15.7 0.62	2.0 0.08	237.0 9.33	241.0 9.49	2.0 0.08	263.0 10.35	259.0 10.20	0.2 0.01	2.4 0.10	693.6	584.8	0.1422	1.85 4.09

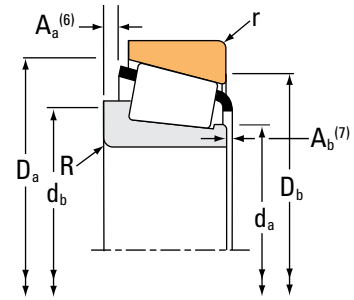
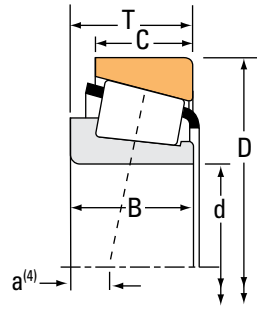
⁽⁴⁾Negative value indicates effective center inside cone (inner-ring) backface.
⁽⁵⁾These maximum fillet radii will be cleared by the bearing corners.
⁽⁶⁾Negative value indicates cage extends beyond cone (inner-ring) backface.
⁽⁷⁾Negative value indicates cage that does not extend beyond cone (inner-ring) front face.

Continued on next page.

TAPERED ROLLER BEARINGS

SINGLE-ROW • TYPE TS

TYPE TS



Bearing Dimensions			Load Ratings							Part Number		
Bore d	O.D. D	Width T	Dynamic ⁽¹⁾		Factors ⁽²⁾		Dynamic ⁽³⁾		Factors ⁽²⁾	Static	Inner	Outer
			C ₁	e	Y	C ₉₀	C _{a90}	K	C ₀			
mm in.	mm in.	mm in.	N lbf			N lbf	N lbf			N lbf		
231.775 9.1250	295.275 11.6250	33.338 1.3125	238000 53400	0.40	1.49	61600 13900	42400 9530	1.45	458000 103000		544091	544116
231.775 9.1250	300.038 11.8125	33.338 1.3125	238000 53400	0.40	1.49	61600 13900	42400 9530	1.45	458000 103000		544091	544118
231.775 9.1250	336.550 13.2500	65.088 2.5625	789000 177000	0.33	1.80	204000 46000	116000 26200	1.76	1570000 352000		M246942	M246910
231.775 9.1250	358.775 14.1250	71.438 2.8125	1150000 258000	0.33	1.80	297000 66900	169000 38100	1.76	1850000 416000		M249734H	M249710X
234.950 9.2500	311.150 12.2500	46.038 1.8125	441000 99200	0.36	1.66	114000 25700	70900 15900	1.61	926000 208000		LM446349	LM446310
234.950 9.2500	314.325 12.3750	49.212 1.9375	519000 117000	0.40	1.51	135000 30200	91500 20600	1.47	1040000 233000		LM545849	LM545810
234.950 9.2500	314.325 12.3750	49.212 1.9375	519000 117000	0.40	1.51	135000 30200	91500 20600	1.47	1040000 233000		LM545849A	LM545810
234.950 9.2500	314.325 12.3750	49.212 1.9375	560000 126000	0.40	1.51	145000 32600	98800 22200	1.47	949000 213000		LM545849E	LM545810
234.950 9.2500	317.500 12.5000	49.212 1.9375	519000 117000	0.40	1.51	135000 30200	91500 20600	1.47	1040000 233000		LM545849	LM545812
234.950 9.2500	320.675 12.6250	50.800 2.0000	552000 124000	0.49	1.23	143000 32200	119000 26800	1.20	821000 185000		88925	88126
234.950 9.2500	327.025 12.8750	52.388 2.0625	552000 124000	0.49	1.23	143000 32200	119000 26800	1.20	821000 185000		88925	88128
234.950 9.2500	327.025 12.8750	52.388 2.0625	558000 126000	0.41	1.48	145000 32500	101000 22700	1.44	1070000 240000		8575	8520
234.950 9.2500	355.600 14.0000	68.262 2.6875	759000 171000	0.59	1.02	197000 44200	199000 44700	0.99	1420000 319000		96925	96140
234.950 9.2500	381.000 15.0000	74.612 2.9375	1260000 283000	0.33	1.80	326000 73200	185000 41700	1.76	2030000 455000		M252330	M252310
234.950 9.2500	384.175 15.1250	112.712 4.4375	1670000 377000	0.33	1.80	434000 97600	247000 55600	1.76	3110000 699000		H247549	H247510
234.950 9.2500	384.175 15.1250	112.713 4.4375	1880000 422000	0.33	1.80	486000 109000	277000 62200	1.76	3370000 757000		H247548	H247510
235.077 9.2550	314.325 12.3750	49.212 1.9375	613000 138000	0.40	1.51	159000 35700	108000 24300	1.47	949000 213000		LM545847	LM545810

⁽¹⁾Based on 1 x 10⁶ revolutions L₁₀ life, for the ISO life-calculation method.

⁽²⁾Consult your Timken engineer for instructions on use or review the Timken Engineering Manual on timken.com/catalogs.

⁽³⁾Based on 90 x 10⁶ revolutions L₁₀ life, for The Timken Company life-calculation method. C₉₀ and C_{a90} are radial and thrust values.

Bearing Dimensions											Geometry Factors			Bearing Weight
Width B	Width C	Eff. Ctr. a ⁽⁴⁾	Shaft			Housing			Cage		G ₁	G ₂	C _g	
			Max Shaft Fillet Radius R ⁽⁵⁾	Backing Shoulder Dia. d _a	mm in.	Max Housing Fillet Radius r ⁽⁵⁾	Backing Shoulder Dia. D _a	mm in.	A _a ⁽⁶⁾	A _b ⁽⁷⁾				
mm in.	mm in.	mm in.	mm in.	mm in.	mm in.	mm in.	mm in.	mm in.	mm in.	mm in.			kg lbs.	
31.750 1.2500	23.812 0.9375	15.7 0.62	3.5 0.14	243.1 9.57	246.9 9.72	3.3 0.13	287.0 11.30	280.0 11.02	4.2 0.16	2.8 0.11	648.6	279.2	0.1174	4.85 10.68
31.750 1.2500	23.812 0.9375	15.7 0.62	3.5 0.14	243.1 9.57	246.9 9.72	3.3 0.13	287.0 11.30	282.0 11.10	4.2 0.16	2.8 0.11	648.6	279.2	0.1174	5.24 11.54
65.088 2.5625	50.800 2.0000	-4.8 -0.19	6.4 0.25	249.0 9.80	258.0 10.16	3.3 0.13	322.0 12.68	313.0 12.32	5.1 0.20	3.3 0.13	1354.6	198.0	0.1436	18.53 40.85
71.438 2.8125	53.975 2.1250	-6.9 -0.27	6.4 0.25	255.0 10.04	265.0 10.43	3.3 0.13	343.0 13.50	335.0 13.19	7.9 0.31	3.1 0.13	1626.0	173.0	0.1526	26.40 58.20
46.038 1.8125	33.338 1.3125	6.6 0.26	3.5 0.14	246.0 9.69	252.0 9.92	3.3 0.13	301.0 11.85	294.0 11.57	5.5 0.21	1.6 0.07	1008.4	243.6	0.1328	8.70 19.18
49.212 1.9375	36.512 1.4375	8.4 0.33	3.5 0.14	246.0 9.69	252.0 9.92	3.3 0.13	306.0 12.05	296.0 11.65	4.4 0.17	2.9 0.12	997.1	163.2	0.1367	9.85 21.70
49.212 1.9375	36.512 1.4375	8.4 0.33	6.4 0.25	246.0 9.69	258.0 10.16	3.3 0.13	306.0 12.05	296.0 11.65	4.4 0.17	2.9 0.12	997.1	163.2	0.1367	9.91 21.84
53.975 2.1250	36.512 1.4375	8.4 0.33	3.5 0.14	247.0 9.72	252.0 9.92	3.3 0.13	306.0 12.05	296.0 11.65	4.2 0.16	0.0 0.00	938.2	175.8	0.1338	10.18 22.42
49.212 1.9375	36.512 1.4375	8.4 0.33	3.5 0.14	246.0 9.69	252.0 9.92	3.3 0.13	306.0 12.05	297.0 11.69	4.4 0.17	2.9 0.12	997.1	163.2	0.1367	10.27 22.63
49.212 1.9375	33.338 1.3125	14.2 0.56	6.4 0.25	246.0 9.69	258.0 10.16	3.3 0.13	309.0 12.17	299.0 11.77	11.1 0.43	2.7 0.11	800.1	189.1	0.1352	10.12 22.31
49.212 1.9375	34.925 1.3750	14.2 0.56	6.4 0.25	246.0 9.69	258.0 10.16	3.3 0.13	309.0 12.17	302.0 11.89	11.1 0.43	2.7 0.11	800.1	189.1	0.1352	11.19 24.69
52.388 2.0625	36.512 1.4375	7.6 0.30	6.4 0.25	248.0 9.76	259.0 10.20	3.3 0.13	313.0 12.32	305.0 12.01	7.0 0.27	2.2 0.09	1050.5	172.4	0.1401	12.32 27.16
66.675 2.6250	47.625 1.8750	17.0 0.67	7.0 0.28	254.0 10.00	265.0 10.43	3.3 0.13	334.0 13.15	318.0 12.52	11.9 0.47	3.8 0.15	1140.0	160.6	0.1626	22.15 48.85
74.612 2.9375	57.150 2.2500	-6.6 -0.26	6.4 0.25	261.0 10.28	271.0 10.67	3.3 0.13	364.0 14.32	356.0 14.02	8.3 0.32	3.6 0.14	1839.2	226.1	0.1588	33.48 73.80
112.712 4.4375	90.488 3.5625	-27.9 -1.10	6.4 0.25	263.0 10.35	273.0 10.75	6.4 0.25	362.5 14.27	346.0 13.62	10.2 0.40	2.9 0.12	1964.4	148.4	0.1638	50.04 110.32
112.712 4.4375	90.488 3.5625	-27.9 -1.10	6.4 0.25	259.0 10.20	269.0 10.59	6.4 0.25	362.5 14.27	346.0 13.62	8.5 0.33	4.4 0.18	2077.6	156.6	0.1671	51.64 113.84
53.975 2.1250	36.512 1.4375	8.4 0.33	3.5 0.14	247.0 9.72	252.0 9.92	3.3 0.13	306.0 12.05	296.0 11.65	4.2 0.16	0.0 0.00	938.2	175.8	0.1338	10.16 22.37

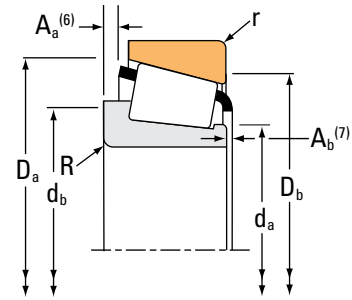
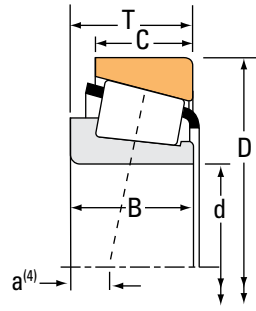
⁽⁴⁾Negative value indicates effective center inside cone (inner-ring) backface.
⁽⁵⁾These maximum fillet radii will be cleared by the bearing corners.
⁽⁶⁾Negative value indicates cage extends beyond cone (inner-ring) backface.
⁽⁷⁾Negative value indicates cage that does not extend beyond cone (inner-ring) front face.

Continued on next page.

TAPERED ROLLER BEARINGS

SINGLE-ROW • TYPE TS

TYPE TS



Bearing Dimensions			Load Ratings							Part Number			
Bore d	O.D. D	Width T	Dynamic ⁽¹⁾		Factors ⁽²⁾		Dynamic ⁽³⁾		Factors ⁽²⁾		Static C ₀	Inner	Outer
			C ₁	e	Y	C ₉₀	C _{a90}	K	N	N			
mm in.	mm in.	mm in.	N lbf			N lbf	N lbf		N lbf				
235.331 9.2650	336.550 13.2500	65.088 2.5625	924000 208000	0.33	1.80	240000 53800	136000 30700	1.76	1420000 319000		M246947	M246910	
235.331 9.2650	336.550 13.2500	65.088 2.5625	924000 208000	0.33	1.80	240000 53800	136000 30700	1.76	1420000 319000		M246947AA	M246910	
236.538 9.3125	320.675 12.6250	44.450 1.7500	552000 124000	0.49	1.23	143000 32200	119000 26800	1.20	821000 185000		88931	88126	
236.538 9.3125	320.675 12.6250	44.450 1.7500	552000 124000	0.49	1.23	143000 32200	119000 26800	1.20	821000 185000		88931H	88126	
237.330 9.3437	336.550 13.2500	65.088 2.5625	789000 177000	0.33	1.80	204000 46000	116000 26200	1.76	1570000 352000		M246949	M246910	
237.330 9.3437	336.550 13.2500	65.088 2.5625	845000 190000	0.33	1.80	219000 49200	125000 28000	1.76	1420000 319000		M246948	M246910	
237.330 9.3437	358.775 14.1250	71.438 2.8125	914000 206000	0.33	1.80	237000 53300	135000 30300	1.76	1850000 416000		M249736	M249710	
240.000 9.4488	320.000 12.5984	42.000 1.6535	440000 99000	0.46	1.31	114000 25700	89300 20100	1.28	808000 182000		JP24049	JP24010	
241.122 9.4930	368.300 14.5000	68.262 2.6875	844000 190000	0.34	1.75	219000 49200	129000 28900	1.70	1530000 345000		EE125094	125145	
241.300 9.5000	327.025 12.8750	52.388 2.0625	527000 119000	0.41	1.48	137000 30700	95200 21400	1.44	1070000 240000		8578	8520	
241.300 9.5000	349.148 13.7460	57.150 2.2500	660000 148000	0.35	1.70	171000 38500	103000 23300	1.65	1250000 282000		EE127095	127135	
241.300 9.5000	355.498 13.9960	57.150 2.2500	660000 148000	0.35	1.70	171000 38500	103000 23300	1.65	1250000 282000		EE127095	127138	
241.300 9.5000	355.600 14.0000	50.800 2.0000	643000 144000	0.36	1.65	167000 37500	104000 23300	1.61	1030000 231000		EE170950	171400	
241.300 9.5000	355.600 14.0000	57.150 2.2500	660000 148000	0.35	1.70	171000 38500	103000 23300	1.65	1250000 282000		EE127095	127140	
241.300 9.5000	365.049 14.3720	50.800 2.0000	643000 144000	0.36	1.65	167000 37500	104000 23300	1.61	1030000 231000		EE170950	171436	
241.300 9.5000	368.300 14.5000	50.800 2.0000	643000 144000	0.36	1.65	167000 37500	104000 23300	1.61	1030000 231000		EE170950	171450	
241.300 9.5000	368.300 14.5000	68.262 2.6875	844000 190000	0.34	1.75	219000 49200	129000 28900	1.70	1530000 345000		EE125095	125145	

⁽¹⁾Based on 1 x 10⁶ revolutions L₁₀ life, for the ISO life-calculation method.

⁽²⁾Consult your Timken engineer for instructions on use or review the Timken Engineering Manual on timken.com/catalogs.

⁽³⁾Based on 90 x 10⁶ revolutions L₁₀ life, for The Timken Company life-calculation method. C₉₀ and C_{a90} are radial and thrust values.

Bearing Dimensions											Geometry Factors			Bearing Weight
Width B	Width C	Eff. Ctr. a ⁽⁴⁾	Shaft			Housing			Cage		G ₁	G ₂	C _g	
			Max Shaft Fillet Radius R ⁽⁵⁾	Backing Shoulder Dia. d _a	Backing Shoulder Dia. d _b	Max Housing Fillet Radius r ⁽⁵⁾	Backing Shoulder Dia. D _a	Backing Shoulder Dia. D _b	A _a ⁽⁶⁾	A _b ⁽⁷⁾				
mm in.	mm in.	mm in.	mm in.	mm in.	mm in.	mm in.	mm in.	mm in.	mm in.	mm in.				
69.850 2.7500	50.800 2.0000	-4.8 -0.19	2.3 0.09	251.0 9.88	253.0 9.96	3.3 0.13	322.0 12.68	313.0 12.32	4.2 0.16	1.2 0.05	1264.4	185.4	0.1401	18.28 40.30
65.088 2.5625	50.800 2.0000	-4.8 -0.19	2.3 0.09	251.0 9.88	253.0 9.96	3.3 0.13	322.0 12.68	313.0 12.32	4.2 0.16	6.0 0.24	1264.4	185.4	0.1401	17.83 39.31
44.450 1.7500	33.338 1.3125	20.6 0.81	3.5 0.14	247.0 9.72	254.0 10.00	3.3 0.13	309.0 12.17	299.0 11.77	4.8 0.18	1.1 0.05	800.1	189.1	0.1352	9.36 20.61
44.450 1.7500	33.338 1.3125	20.6 0.81	3.5 0.14	248.0 9.76	253.0 9.96	3.3 0.13	309.0 12.17	299.0 11.77	4.8 0.18	1.1 0.05	800.1	189.1	0.1352	9.25 20.39
65.088 2.5625	50.800 2.0000	-4.8 -0.19	6.4 0.25	253.0 9.96	262.0 10.31	3.3 0.13	322.0 12.68	313.0 12.32	5.1 0.20	3.3 0.13	1354.6	198.0	0.1436	17.49 38.54
69.850 2.7500	50.800 2.0000	-4.8 -0.19	6.4 0.25	253.0 9.96	263.0 10.35	3.3 0.13	322.0 12.68	313.0 12.32	4.2 0.16	1.2 0.05	1264.4	185.4	0.1401	17.83 39.30
71.438 2.8125	53.975 2.1250	-6.9 -0.27	6.4 0.25	258.0 10.16	267.0 10.51	3.3 0.13	343.0 13.50	335.0 13.19	8.0 0.31	3.1 0.12	1626.0	173.0	0.1526	24.91 54.91
39.000 1.5354	30.000 1.1811	19.6 0.77	3.0 0.12	252.0 9.92	257.0 10.12	3.0 0.12	310.0 12.20	304.0 11.97	4.7 0.18	4.6 0.18	804.0	198.2	0.1326	8.24 18.17
68.262 2.6875	53.975 2.1250	-2.3 -0.09	6.4 0.25	257.0 10.12	269.0 10.59	3.3 0.13	343.9 13.54	341.1 13.43	7.7 0.30	0.2 0.01	1309.0	221.1	0.1432	24.45 53.90
52.388 2.0625	36.512 1.4375	7.6 0.30	6.4 0.25	253.0 9.96	264.0 10.39	3.3 0.13	313.0 12.32	305.0 12.01	7.0 0.27	2.2 0.09	1050.5	172.4	0.1401	11.34 25.01
57.150 2.2500	44.450 1.7500	2.5 0.10	6.4 0.25	257.0 10.12	267.0 10.51	3.3 0.13	329.0 12.95	325.0 12.80	6.4 0.25	1.7 0.07	1178.6	164.4	0.1392	16.53 36.44
57.150 2.2500	44.450 1.7500	2.5 0.10	6.4 0.25	257.0 10.12	267.0 10.51	3.3 0.13	329.0 12.95	327.0 12.87	6.4 0.25	1.7 0.07	1178.6	164.4	0.1392	17.75 39.13
50.800 2.0000	33.338 1.3125	5.8 0.23	6.4 0.25	260.0 10.24	269.0 10.59	3.3 0.13	337.0 13.27	334.0 13.15	8.6 0.33	3.3 0.13	1068.6	171.6	0.1354	15.42 33.98
57.150 2.2500	44.450 1.7500	2.5 0.10	6.4 0.25	257.0 10.12	267.0 10.51	3.3 0.13	329.0 12.95	327.0 12.87	6.4 0.25	1.7 0.07	1178.6	164.4	0.1392	17.77 39.18
50.800 2.0000	33.338 1.3125	5.8 0.23	6.4 0.25	260.0 10.24	269.0 10.59	3.3 0.13	337.0 13.27	338.0 13.31	8.6 0.33	3.3 0.13	1068.6	171.6	0.1354	16.81 37.05
50.800 2.0000	33.338 1.3125	5.8 0.23	6.4 0.25	260.0 10.24	269.0 10.59	3.3 0.13	337.0 13.27	340.0 13.39	8.6 0.33	3.3 0.13	1068.6	171.6	0.1354	17.30 38.12
68.262 2.6875	53.975 2.1250	-2.3 -0.09	6.4 0.25	257.0 10.12	269.0 10.59	3.3 0.13	343.9 13.54	341.1 13.43	7.7 0.30	0.2 0.01	1309.0	221.1	0.1432	24.12 53.18

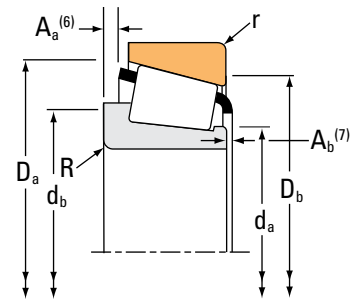
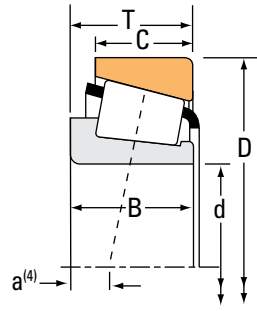
⁽⁴⁾Negative value indicates effective center inside cone (inner-ring) backface.
⁽⁵⁾These maximum fillet radii will be cleared by the bearing corners.
⁽⁶⁾Negative value indicates cage extends beyond cone (inner-ring) backface.
⁽⁷⁾Negative value indicates cage that does not extend beyond cone (inner-ring) front face.

Continued on next page.

TAPERED ROLLER BEARINGS

SINGLE-ROW • TYPE TS

TYPE TS



Bearing Dimensions			Load Ratings							Part Number		
Bore d	O.D. D	Width T	Dynamic ⁽¹⁾ C ₁		Factors ⁽²⁾ e Y		Dynamic ⁽³⁾ C ₉₀ C _{a90}		Factors ⁽²⁾ K	Static C ₀	Inner	Outer
			N	lbf	N	lbf	N	N	N	N		
mm in.	mm in.	mm in.	N	lbf			N	N		N		
241.300 9.5000	393.700 15.5000	73.817 2.9062	1010000 228000		0.40	1.49	262000 59000	181000 40600	1.45	1600000 359000	EE275095	275155
241.300 9.5000	403.225 15.8750	69.850 2.7500	1010000 228000		0.40	1.49	262000 59000	181000 40600	1.45	1600000 359000	EE275095	275158
241.300 9.5000	406.400 16.0000	69.850 2.7500	1010000 228000		0.40	1.49	262000 59000	181000 40600	1.45	1600000 359000	EE275095	275160
241.300 9.5000	444.500 17.5000	101.600 4.0000	1820000 409000		0.34	1.78	472000 106000	273000 61300	1.73	2420000 544000	EE923095	923175
241.300 9.5000	488.950 19.2500	120.650 4.7500	2420000 544000		0.31	1.92	628000 141000	336000 75600	1.87	3310000 744000	EE295950	295193
241.300 9.5000	508.000 20.0000	117.475 4.6250	1430000 322000		0.94	0.64	371000 83500	596000 134000	0.62	2100000 473000	EE390095	390200
243.683 9.5938	315.912 12.4375	31.750 1.2500	270000 60700		0.43	1.39	70000 15700	51500 11600	1.36	561000 126000	LL648434	LL648415
244.475 9.6250	381.000 15.0000	79.375 3.1250	907000 204000		0.52	1.16	235000 52900	208000 46800	1.13	1690000 381000	EE126097	126150
247.650 9.7500	304.800 12.0000	22.225 0.8750	157000 35400		0.32	1.85	40800 9170	22700 5100	1.80	373000 83900	28880	28820
247.650 9.7500	346.075 13.6250	63.500 2.5000	850000 191000		0.34	1.75	220000 49500	130000 29100	1.70	1620000 365000	M348449	M348410
247.650 9.7500	355.600 14.0000	50.800 2.0000	643000 144000		0.36	1.65	167000 37500	104000 23300	1.61	1030000 231000	EE170975	171400
247.650 9.7500	365.049 14.3720	50.800 2.0000	643000 144000		0.36	1.65	167000 37500	104000 23300	1.61	1030000 231000	EE170975	171436
247.650 9.7500	368.300 14.5000	50.800 2.0000	643000 144000		0.36	1.65	167000 37500	104000 23300	1.61	1030000 231000	EE170975	171450
247.650 9.7500	381.000 15.0000	74.612 2.9375	1150000 258000		0.33	1.80	298000 67000	170000 38100	1.76	2030000 455000	M252337	M252310
247.650 9.7500	406.400 16.0000	115.887 4.5625	2470000 554000		0.33	1.80	639000 144000	364000 81800	1.76	3770000 846000	HH249949H	HH249910
247.650 9.7500	406.400 16.0000	115.888 4.5625	2080000 468000		0.33	1.80	539000 121000	307000 69000	1.76	3770000 846000	HH249949	HH249910
247.650 9.7500	444.500 17.5000	139.700 5.5000	3130000 705000		0.29	2.06	813000 183000	406000 91200	2.00	4470000 1000000	NP544119	NP225734

⁽¹⁾Based on 1 x 10⁶ revolutions L₁₀ life, for the ISO life-calculation method.

⁽²⁾Consult your Timken engineer for instructions on use or review the Timken Engineering Manual on timken.com/catalogs.

⁽³⁾Based on 90 x 10⁶ revolutions L₁₀ life, for The Timken Company life-calculation method. C₉₀ and C_{a90} are radial and thrust values.

Bearing Dimensions											Geometry Factors			Bearing Weight
Width B	Width C	Eff. Ctr. a ⁽⁴⁾	Shaft			Housing			Cage		G ₁	G ₂	C _g	
			Max Shaft Fillet Radius R ⁽⁵⁾	Backing Shoulder Dia. d _a	Backing Shoulder Dia. d _b	Max Housing Fillet Radius r ⁽⁵⁾	Backing Shoulder Dia. D _a	Backing Shoulder Dia. D _b	A _a ⁽⁶⁾	A _b ⁽⁷⁾				
mm in.	mm in.	mm in.	mm in.	mm in.	mm in.	mm in.	mm in.	mm in.	mm in.	mm in.				kg lbs.
69.850 2.7500	50.005 1.9687	2.5 0.10	6.4 0.25	268.0 10.55	278.0 10.94	6.4 0.25	378.1 14.89	366.0 14.41	14.4 0.56	3.3 0.13	1451.8	201.3	0.1555	31.91 70.36
69.850 2.7500	46.038 1.8125	2.5 0.10	6.4 0.25	268.0 10.55	278.0 10.94	6.4 0.25	378.1 14.89	371.0 14.61	14.4 0.56	3.3 0.13	1451.8	201.3	0.1555	33.30 73.41
69.850 2.7500	46.038 1.8125	2.5 0.10	6.4 0.25	268.0 10.55	278.0 10.94	6.4 0.25	378.5 14.90	373.0 14.69	14.4 0.56	3.3 0.13	1451.8	201.3	0.1555	34.15 75.30
100.012 3.9375	76.200 3.0000	-19.3 -0.76	6.4 0.25	268.0 10.55	277.0 10.91	4.8 0.19	407.0 16.02	403.0 15.87	12.2 0.48	2.1 0.09	1626.7	136.5	0.1531	65.65 144.73
120.650 4.7500	92.075 3.6250	-31.0 -1.22	6.4 0.25	276.0 10.87	285.0 11.22	6.4 0.25	450.5 17.74	444.0 17.48	18.6 0.73	4.0 0.16	2247.3	171.9	0.1664	103.07 227.24
95.250 3.7500	73.025 2.8750	49.5 1.95	6.4 0.25	288.0 11.34	297.0 11.69	6.4 0.25	456.2 17.96	423.0 16.65	22.4 0.88	18.9 0.75	1258.2	106.2	0.1909	94.79 208.97
31.750 1.2500	22.225 0.8750	22.4 0.88	3.5 0.14	254.0 10.00	260.0 10.24	3.3 0.13	305.0 12.01	300.0 11.81	4.6 0.18	1.5 0.06	817.0	322.2	0.1295	5.84 12.89
76.200 3.0000	57.150 2.2500	9.7 0.38	6.4 0.25	266.0 10.47	275.0 10.83	4.8 0.19	358.0 14.09	343.0 13.50	13.0 0.51	2.0 0.08	1321.8	168.9	0.1640	30.34 66.87
22.225 0.8750	15.875 0.6250	17.3 0.68	1.5 0.06	256.0 10.08	258.0 10.16	1.5 0.06	294.0 11.57	291.0 11.46	1.6 0.06	1.9 0.08	807.0	572.7	0.1479	3.18 7.01
63.500 2.5000	50.800 2.0000	-1.3 -0.05	6.4 0.25	263.0 10.35	273.0 10.75	6.4 0.25	332.0 13.07	321.0 12.64	4.0 0.15	3.7 0.15	1450.8	212.9	0.1483	17.60 38.81
50.800 2.0000	33.338 1.3125	5.8 0.23	6.4 0.25	264.0 10.39	274.0 10.79	3.3 0.13	337.0 13.27	334.0 13.15	8.6 0.33	3.3 0.13	1068.6	171.6	0.1354	14.44 31.83
50.800 2.0000	33.338 1.3125	5.8 0.23	6.4 0.25	264.0 10.39	274.0 10.79	3.3 0.13	337.0 13.27	338.0 13.31	8.6 0.33	3.3 0.13	1068.6	171.6	0.1354	15.83 34.90
50.800 2.0000	33.338 1.3125	5.8 0.23	6.4 0.25	264.0 10.39	274.0 10.79	3.3 0.13	337.0 13.27	340.0 13.39	8.6 0.33	3.3 0.13	1068.6	171.6	0.1354	16.32 35.98
74.612 2.9375	57.150 2.2500	-6.6 -0.26	6.4 0.25	270.0 10.63	280.0 11.02	3.3 0.13	364.0 14.32	356.0 14.02	8.3 0.32	3.6 0.14	1839.2	226.1	0.1588	30.51 67.25
117.475 4.6250	93.662 3.6875	-28.7 -1.13	6.4 0.25	278.0 10.94	288.0 11.34	6.4 0.25	383.0 15.08	366.0 14.41	8.9 0.35	4.1 0.16	2373.9	173.3	0.1746	60.55 133.51
117.475 4.6250	93.662 3.6875	-28.7 -1.13	6.4 0.25	275.0 10.83	284.0 11.18	6.4 0.25	383.0 15.08	366.0 14.41	8.9 0.35	4.1 0.16	2373.9	173.3	0.1746	60.60 133.60
139.700 5.5000	120.650 4.7500	-41.7 -1.64	6.4 0.25	281.0 11.06	291.0 11.46	6.4 0.25	413.5 16.28	396.0 15.59	8.3 0.32	5.2 0.21	2724.6	139.8	0.1748	96.14 211.94

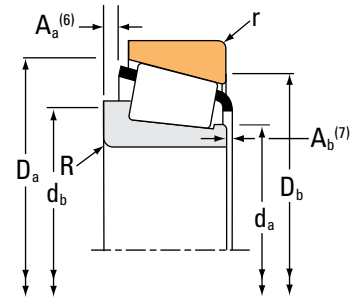
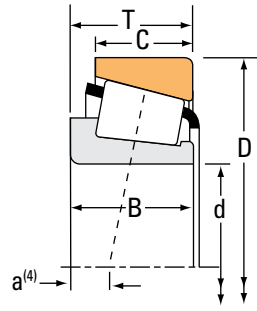
⁽⁴⁾Negative value indicates effective center inside cone (inner-ring) backface.
⁽⁵⁾These maximum fillet radii will be cleared by the bearing corners.
⁽⁶⁾Negative value indicates cage extends beyond cone (inner-ring) backface.
⁽⁷⁾Negative value indicates cage that does not extend beyond cone (inner-ring) front face.

Continued on next page.

TAPERED ROLLER BEARINGS

SINGLE-ROW • TYPE TS

TYPE TS



Bearing Dimensions			Load Ratings							Part Number	
Bore d	O.D. D	Width T	Dynamic ⁽¹⁾ C ₁	Factors ⁽²⁾ e Y		Dynamic ⁽³⁾ C ₉₀ C _{a90}		Factors ⁽²⁾ K	Static C ₀	Inner	Outer
mm in.	mm in.	mm in.	N lbf			N lbf	N lbf		N lbf		
249.250 9.8130	381.000 15.0000	79.375 3.1250	907000 204000	0.52	1.16	235000 52900	208000 46800	1.13	1690000 381000	EE126098	126150
254.000 10.0000	315.912 12.4375	31.750 1.2500	255000 57300	0.43	1.39	66100 14900	48700 10900	1.36	561000 126000	LL648449	LL648415
254.000 10.0000	315.912 12.4375	31.750 1.2500	255000 57300	0.43	1.39	66100 14900	48700 10900	1.36	561000 126000	LL648449	LL648416
254.000 10.0000	323.850 12.7500	22.225 0.8750	151000 33900	0.35	1.73	39200 8800	23200 5220	1.69	391000 87800	29875	29820
254.000 10.0000	358.775 14.1250	71.438 2.8125	914000 206000	0.33	1.80	237000 53300	135000 30300	1.76	1850000 416000	M249749	M249710
254.000 10.0000	358.775 14.1250	71.438 2.8125	1150000 258000	0.33	1.80	297000 66900	169000 38100	1.76	1850000 416000	M249749H	M249710X
254.000 10.0000	358.775 14.1250	71.438 2.8125	914000 206000	0.33	1.80	237000 53300	135000 30300	1.76	1850000 416000	M249749X	M249710
254.000 10.0000	365.125 14.3750	58.738 2.3125	679000 153000	0.37	1.60	176000 39600	113000 25400	1.56	1330000 299000	EE134100	134143
254.000 10.0000	368.300 14.5000	58.738 2.3125	679000 153000	0.37	1.60	176000 39600	113000 25400	1.56	1330000 299000	EE134100	134145
254.000 10.0000	393.700 15.5000	73.817 2.9062	1010000 228000	0.40	1.49	262000 59000	181000 40600	1.45	1600000 359000	EE275100	275155
254.000 10.0000	400.050 15.7500	57.150 2.2500	782000 176000	0.33	1.81	203000 45600	115000 25900	1.76	1390000 313000	EE251001	251575
254.000 10.0000	403.225 15.8750	69.850 2.7500	1010000 228000	0.40	1.49	262000 59000	181000 40600	1.45	1600000 359000	EE275100	275158
254.000 10.0000	406.400 16.0000	69.850 2.7500	1010000 228000	0.40	1.49	262000 59000	181000 40600	1.45	1600000 359000	EE275100	275160
254.000 10.0000	422.275 16.6250	86.121 3.3906	1550000 348000	0.33	1.80	401000 90100	228000 51300	1.76	2110000 475000	HM252344	HM252310
254.000 10.0000	422.275 16.6250	86.121 3.3906	1500000 337000	0.33	1.80	389000 87400	221000 49700	1.76	2020000 455000	HM252343	HM252310
254.000 10.0000	431.724 16.9970	82.550 3.2500	1500000 337000	0.33	1.80	389000 87400	221000 49700	1.76	2020000 455000	HM252343	HM252315
254.000 10.0000	444.500 17.5000	76.200 3.0000	1180000 264000	0.34	1.76	305000 68500	178000 40000	1.71	1740000 392000	EE822100	822175

⁽¹⁾Based on 1 x 10⁶ revolutions L₁₀ life, for the ISO life-calculation method.

⁽²⁾Consult your Timken engineer for instructions on use or review the Timken Engineering Manual on timken.com/catalogs.

⁽³⁾Based on 90 x 10⁶ revolutions L₁₀ life, for The Timken Company life-calculation method. C₉₀ and C_{a90} are radial and thrust values.

Bearing Dimensions											Geometry Factors			Bearing Weight
Width B	Width C	Eff. Ctr. a ⁽⁴⁾	Shaft			Housing			Cage		G ₁	G ₂	C _g	
			Max Shaft Fillet Radius R ⁽⁵⁾	Backing Shoulder Dia. d _a	Backing Shoulder Dia. d _b	Max Housing Fillet Radius r ⁽⁵⁾	Backing Shoulder Dia. D _a	Backing Shoulder Dia. D _b	A _a ⁽⁶⁾	A _b ⁽⁷⁾				
mm in.	mm in.	mm in.	mm in.	mm in.	mm in.	mm in.	mm in.	mm in.	mm in.	mm in.				kg lbs.
76.200 3.0000	57.150 2.2500	9.7 0.38	6.4 0.25	269.0 10.59	279.0 10.98	4.8 0.19	358.0 14.09	343.0 13.50	13.0 0.51	2.0 0.08	1321.8	168.9	0.1640	29.23 64.44
31.750 1.2500	22.225 0.8750	22.4 0.88	3.5 0.14	262.0 10.31	268.0 10.55	3.3 0.13	305.0 12.01	300.0 11.81	4.6 0.18	1.5 0.06	817.0	322.2	0.1295	4.84 10.68
31.750 1.2500	22.225 0.8750	22.4 0.88	3.5 0.14	262.0 10.31	268.0 10.55	4.8 0.19	305.0 12.01	298.0 11.73	4.6 0.18	1.5 0.06	817.0	322.2	0.1295	4.80 10.57
22.225 0.8750	15.875 0.6250	21.1 0.83	1.5 0.06	266.0 10.47	267.0 10.51	1.5 0.06	312.0 12.28	310.0 12.20	1.7 0.06	1.9 0.08	906.8	658.2	0.1567	4.27 9.40
71.438 2.8125	53.975 2.1250	-6.9 -0.27	3.5 0.14	270.0 10.63	274.0 10.79	3.3 0.13	343.0 13.50	335.0 13.19	8.0 0.31	3.1 0.12	1626.0	173.0	0.1526	21.39 47.16
71.438 2.8125	53.975 2.1250	-6.9 -0.27	3.5 0.14	272.0 10.71	276.0 10.87	3.3 0.13	343.0 13.50	335.0 13.19	7.9 0.31	3.1 0.13	1626.0	173.0	0.1526	21.69 47.82
71.438 2.8125	53.975 2.1250	-6.9 -0.27	3.5 0.14	270.0 10.63	274.0 10.79	3.3 0.13	343.0 13.50	335.0 13.19	8.0 0.31	3.1 0.12	1626.0	173.0	0.1526	21.42 47.22
58.738 2.3125	42.862 1.6875	5.1 0.20	6.4 0.25	272.0 10.71	281.0 11.06	6.4 0.25	347.0 13.66	339.0 13.35	8.2 0.32	1.7 0.07	1327.7	187.2	0.1474	18.23 40.20
58.738 2.3125	42.862 1.6875	5.1 0.20	6.4 0.25	272.0 10.71	281.0 11.06	6.4 0.25	347.0 13.66	340.0 13.39	8.2 0.32	1.7 0.07	1327.7	187.2	0.1474	18.85 41.55
69.850 2.7500	50.005 1.9687	2.5 0.10	6.4 0.25	277.0 10.91	287.0 11.30	6.4 0.25	378.1 14.89	366.0 14.41	14.4 0.56	3.3 0.13	1451.8	201.3	0.1555	29.21 64.40
55.562 2.1875	41.275 1.6250	3.3 0.13	3.3 0.13	272.0 10.71	278.0 10.94	1.5 0.06	369.0 14.53	371.0 14.61	6.3 0.24	5.4 0.21	1323.1	218.0	0.1413	24.94 54.95
69.850 2.7500	46.038 1.8125	2.5 0.10	6.4 0.25	277.0 10.91	287.0 11.30	6.4 0.25	378.1 14.89	371.0 14.61	14.4 0.56	3.3 0.13	1451.8	201.3	0.1555	30.60 67.45
69.850 2.7500	46.038 1.8125	2.5 0.10	6.4 0.25	277.0 10.91	287.0 11.30	6.4 0.25	378.5 14.90	373.0 14.69	14.4 0.56	3.3 0.13	1451.8	201.3	0.1555	31.45 69.34
79.771 3.1406	66.675 2.6250	-9.4 -0.37	6.8 0.27	281.0 11.06	287.0 11.30	3.3 0.13	399.5 15.73	392.0 15.43	10.4 0.41	6.1 0.24	1551.8	152.3	0.1498	44.32 97.70
79.771 3.1406	66.675 2.6250	-9.4 -0.37	6.8 0.27	281.0 11.06	287.0 11.30	3.3 0.13	399.5 15.73	392.0 15.43	12.9 0.51	4.8 0.19	1504.3	147.8	0.1482	42.03 92.64
79.771 3.1406	60.325 2.3750	-9.4 -0.37	6.8 0.27	281.0 11.06	287.0 11.30	3.5 0.14	398.3 15.68	397.0 15.63	12.9 0.51	4.8 0.19	1504.3	147.8	0.1482	43.71 96.35
73.025 2.8750	50.800 2.0000	-5.3 -0.21	6.4 0.25	276.1 10.87	288.0 11.34	6.4 0.25	407.9 16.06	404.9 15.94	12.1 0.47	6.5 0.26	1363.4	186.1	0.1442	43.84 96.65

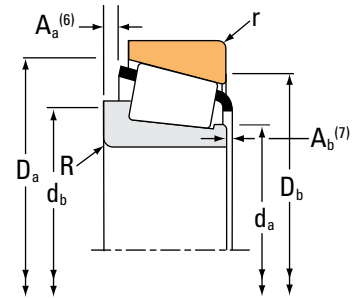
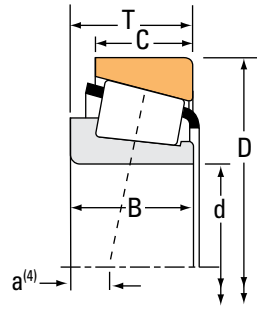
(4) Negative value indicates effective center inside cone (inner-ring) backface.
 (5) These maximum fillet radii will be cleared by the bearing corners.
 (6) Negative value indicates cage extends beyond cone (inner-ring) backface.
 (7) Negative value indicates cage that does not extend beyond cone (inner-ring) front face.

Continued on next page.

TAPERED ROLLER BEARINGS

SINGLE-ROW • TYPE TS

TYPE TS



Bearing Dimensions			Load Ratings							Part Number		
Bore d	O.D. D	Width T	Dynamic ⁽¹⁾		Factors ⁽²⁾		Dynamic ⁽³⁾		Factors ⁽²⁾	Static	Inner	Outer
			C ₁	e	Y	C ₉₀	C _{a90}	K	C ₀			
mm in.	mm in.	mm in.	N lbf			N lbf	N lbf			N lbf		
254.000 10.0000	495.300 19.5000	76.200 3.0000	1550000 348000	0.40	1.49	402000 90300	277000 62200	1.45		2090000 471000	EE941002	941950
254.000 10.0000	495.300 19.5000	141.288 5.5625	2870000 645000	0.33	1.80	744000 167000	423000 95200	1.76		5650000 1270000	HH258232	HH258210
254.000 10.0000	533.400 21.0000	133.350 5.2500	2680000 603000	0.94	0.64	696000 156000	1120000 251000	0.62		3090000 694000	HH953749	HH953710
254.000 10.0000	533.400 21.0000	133.350 5.2500	2680000 603000	0.94	0.64	696000 156000	1120000 251000	0.62		3090000 694000	HH953749	HH953710X
254.000 10.0000	558.800 22.0000	123.825 4.8750	1800000 404000	0.87	0.69	466000 105000	691000 155000	0.67		2680000 603000	EE620100	620220
257.175 10.1250	342.900 13.5000	57.150 2.2500	780000 175000	0.35	1.73	202000 45500	120000 27000	1.68		1430000 321000	M349549	M349510
257.175 10.1250	342.900 13.5000	57.150 2.2500	780000 175000	0.35	1.73	202000 45500	120000 27000	1.68		1430000 321000	M349549A	M349510
258.762 10.1875	400.050 15.7500	69.850 2.7500	949000 213000	0.39	1.52	246000 55300	166000 37400	1.48		1450000 326000	EE221018	221575
260.350 10.2500	365.125 14.3750	58.738 2.3125	679000 153000	0.37	1.60	176000 39600	113000 25400	1.56		1330000 299000	EE134102	134143
260.350 10.2500	368.300 14.5000	58.738 2.3125	679000 153000	0.37	1.60	176000 39600	113000 25400	1.56		1330000 299000	EE134102	134145
260.350 10.2500	400.050 15.7500	69.850 2.7500	949000 213000	0.39	1.52	246000 55300	166000 37400	1.48		1450000 326000	EE221026	221575
260.350 10.2500	406.400 16.0000	69.850 2.7500	924000 208000	0.39	1.55	240000 53900	158000 35600	1.51		1820000 409000	EE128102	128160
260.350 10.2500	419.100 16.5000	85.725 3.3750	1120000 253000	0.60	0.99	291000 65500	302000 67800	0.97		2010000 451000	EE435102	435165
260.350 10.2500	422.275 16.6250	86.121 3.3906	1550000 348000	0.33	1.80	401000 90100	228000 51300	1.76		2110000 475000	HM252349	HM252310
260.350 10.2500	422.275 16.6250	86.121 3.3906	1500000 337000	0.33	1.80	389000 87400	221000 49700	1.76		2020000 455000	HM252348	HM252310
260.350 10.2500	431.724 16.9970	82.550 3.2500	1500000 337000	0.33	1.80	389000 87400	221000 49700	1.76		2020000 455000	HM252348	HM252315
260.350 10.2500	431.724 16.9970	82.550 3.2500	1550000 348000	0.33	1.80	401000 90100	228000 51300	1.76		2110000 475000	HM252349	HM252315

⁽¹⁾Based on 1 x 10⁶ revolutions L₁₀ life, for the ISO life-calculation method.

⁽²⁾Consult your Timken engineer for instructions on use or review the Timken Engineering Manual on timken.com/catalogs.

⁽³⁾Based on 90 x 10⁶ revolutions L₁₀ life, for The Timken Company life-calculation method. C₉₀ and C_{a90} are radial and thrust values.

Bearing Dimensions											Geometry Factors			Bearing Weight
Width B	Width C	Eff. Ctr. a ⁽⁴⁾	Shaft			Housing			Cage		G ₁	G ₂	C _g	
			Max Shaft Fillet Radius R ⁽⁵⁾	Backing Shoulder Dia. d _a	Shoulder Dia. d _b	Max Housing Fillet Radius r ⁽⁵⁾	Backing Shoulder Dia. D _a	Shoulder Dia. D _b	A _a ⁽⁶⁾	A _b ⁽⁷⁾				
mm in.	mm in.	mm in.	mm in.	mm in.	mm in.	mm in.	mm in.	mm in.	mm in.	mm in.				kg lbs.
74.612 2.9375	53.975 2.1250	9.1 0.36	6.4 0.25	292.0 11.50	301.0 11.85	3.3 0.13	462.7 18.22	459.0 18.07	10.2 0.40	6.0 0.24	1771.6	187.4	0.1657	64.61 142.44
141.288 5.5625	114.300 4.5000	-34.5 -1.36	6.4 0.25	295.0 11.61	304.0 11.97	6.4 0.25	467.0 18.40	448.0 17.64	10.6 0.42	7.5 0.30	3853.2	220.0	0.2048	132.43 291.94
120.650 4.7500	77.788 3.0625	45.5 1.79	6.4 0.25	306.3 12.06	328.0 12.91	6.4 0.25	495.6 19.51	455.0 17.91	21.8 0.86	14.3 0.56	1668.7	104.2	0.2101	127.31 280.67
120.650 4.7500	77.788 3.0625	45.5 1.79	6.4 0.25	306.3 12.06	328.0 12.91	6.4 0.25	495.6 19.51	455.0 17.91	21.8 0.86	14.3 0.56	1668.7	104.2	0.2101	127.09 280.20
104.775 4.1250	69.850 2.7500	48.8 1.92	8.0 0.31	308.0 12.13	317.0 12.48	8.0 0.31	501.9 19.76	477.0 18.78	23.9 0.94	17.5 0.69	1730.9	165.3	0.2078	126.87 279.70
57.150 2.2500	44.450 1.7500	2.5 0.10	6.4 0.25	269.0 10.59	281.0 11.06	3.3 0.13	333.0 13.11	322.0 12.68	4.7 0.18	3.0 0.12	1423.3	193.4	0.1475	13.71 30.22
57.150 2.2500	44.450 1.7500	2.5 0.10	10.7 0.42	269.0 10.59	289.0 11.38	3.3 0.13	333.0 13.11	322.0 12.68	4.7 0.18	3.0 0.12	1423.3	193.4	0.1475	13.40 29.53
67.470 2.6563	46.038 1.8125	0.8 0.03	9.7 0.38	279.0 10.98	295.0 11.61	6.4 0.25	371.5 14.63	366.0 14.41	14.3 0.56	5.6 0.22	1320.8	207.5	0.1497	27.08 59.72
58.738 2.3125	42.862 1.6875	5.1 0.20	6.4 0.25	276.0 10.87	286.0 11.26	6.4 0.25	347.0 13.66	339.0 13.35	8.2 0.32	1.7 0.07	1327.7	187.2	0.1474	17.00 37.50
58.738 2.3125	42.862 1.6875	5.1 0.20	6.4 0.25	276.0 10.87	286.0 11.26	6.4 0.25	347.0 13.66	340.0 13.39	8.2 0.32	1.7 0.07	1327.7	187.2	0.1474	17.62 38.85
67.470 2.6563	46.038 1.8125	0.8 0.03	9.7 0.38	280.0 11.02	296.0 11.65	6.4 0.25	371.5 14.63	366.0 14.41	14.3 0.56	5.6 0.22	1320.8	207.5	0.1497	26.74 58.97
67.673 2.6643	53.975 2.1250	6.6 0.26	3.3 0.13	292.0 11.50	288.0 11.34	3.3 0.13	384.0 15.12	378.0 14.88	6.8 0.27	2.1 0.08	1727.7	255.2	0.1628	32.57 71.80
84.138 3.3125	61.912 2.4375	19.8 0.78	6.4 0.25	285.0 11.22	295.0 11.61	3.3 0.13	395.1 15.56	376.0 14.80	14.0 0.55	2.0 0.08	1480.2	123.2	0.1787	41.85 92.26
79.771 3.1406	66.675 2.6250	-9.4 -0.37	6.8 0.27	285.0 11.22	292.0 11.50	3.3 0.13	399.5 15.73	392.0 15.43	10.4 0.41	6.1 0.24	1551.8	152.3	0.1498	42.72 94.17
79.771 3.1406	66.675 2.6250	-9.4 -0.37	6.8 0.27	285.0 11.22	292.0 11.50	3.3 0.13	399.5 15.73	392.0 15.43	12.9 0.51	4.8 0.19	1504.3	147.8	0.1482	40.54 89.36
79.771 3.1406	60.325 2.3750	-9.4 -0.37	6.8 0.27	285.0 11.22	292.0 11.50	3.5 0.14	398.3 15.68	397.0 15.63	12.9 0.51	4.8 0.19	1504.3	147.8	0.1482	42.22 93.07
79.771 3.1406	60.325 2.3750	-9.4 -0.37	6.8 0.27	285.0 11.22	292.0 11.50	3.5 0.14	398.3 15.68	397.0 15.63	10.4 0.41	6.1 0.24	1551.8	152.3	0.1498	44.40 97.88

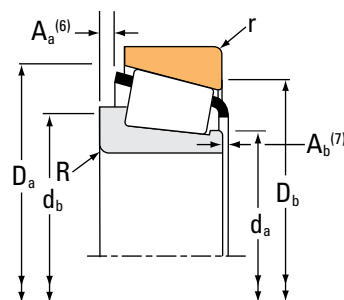
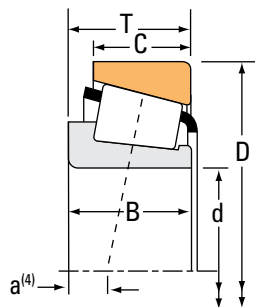
(4) Negative value indicates effective center inside cone (inner-ring) backface.
 (5) These maximum fillet radii will be cleared by the bearing corners.
 (6) Negative value indicates cage extends beyond cone (inner-ring) backface.
 (7) Negative value indicates cage that does not extend beyond cone (inner-ring) front face.

Continued on next page.

TAPERED ROLLER BEARINGS

SINGLE-ROW • TYPE TS

TYPE TS



Bearing Dimensions			Load Ratings							Part Number		
Bore d	O.D. D	Width T	Dynamic ⁽¹⁾		Factors ⁽²⁾		Dynamic ⁽³⁾		Factors ⁽²⁾	Static	Inner	Outer
			C ₁	e	Y	C ₉₀	C _{a90}	K	C ₀			
mm in.	mm in.	mm in.	N lbf			N lbf	N lbf			N lbf		
260.350 10.2500	488.950 19.2500	120.650 4.7500	2420000 544000	0.31	1.92	628000 141000	336000 75600	1.87		3310000 744000	EE295102	295193
263.525 10.3750	325.438 12.8125	28.575 1.1250	221000 49800	0.37	1.64	57400 12900	35900 8080	1.60		554000 125000	38880	38820
263.525 10.3750	355.600 14.0000	57.150 2.2500	805000 181000	0.36	1.67	209000 46900	129000 28900	1.62		1510000 339000	LM451345	LM451310
264.975 10.4321	355.600 14.0000	57.150 2.2500	731000 164000	0.36	1.67	189000 42600	117000 26300	1.62		1310000 296000	LM451347	LM451310
266.560 10.4945	325.438 12.8125	29.500 1.1614	217000 48800	0.37	1.64	56300 12700	35300 7930	1.60		507000 114000	LL450748A	38820
266.560 10.4945	325.438 12.8125	29.500 1.1614	214000 48100	0.37	1.64	55500 12500	34700 7810	1.60		527000 118000	38884	38820
266.700 10.5000	323.850 12.7500	22.225 0.8750	151000 33900	0.35	1.73	39200 8800	23200 5220	1.69		391000 87800	29880	29820
266.700 10.5000	325.438 12.8125	28.575 1.1250	221000 49800	0.37	1.64	57400 12900	35900 8080	1.60		554000 125000	38885	38820
266.700 10.5000	325.438 12.8125	29.500 1.1614	230000 51700	0.37	1.64	59600 13400	37300 8390	1.60		507000 114000	LL450749AA	38820
266.700 10.5000	325.438 12.8125	29.500 1.1614	227000 50900	0.37	1.64	58700 13200	36800 8260	1.60		527000 118000	38886	38820
266.700 10.5000	355.600 14.0000	57.150 2.2500	880000 198000	0.36	1.67	228000 51300	141000 31600	1.62		1510000 339000	LM451349	LM451310
266.700 10.5000	355.600 14.0000	57.150 2.2500	805000 181000	0.36	1.67	209000 46900	129000 28900	1.62		1510000 339000	LM451349A	LM451310
266.700 10.5000	355.600 14.0000	57.150 2.2500	805000 181000	0.36	1.67	209000 46900	129000 28900	1.62		1510000 339000	LM451349AX	LM451310
266.700 10.5000	393.700 15.5000	73.817 2.9062	1010000 228000	0.40	1.49	262000 59000	181000 40600	1.45		1600000 359000	EE275105	275155
266.700 10.5000	403.225 15.8750	69.850 2.7500	1010000 228000	0.40	1.49	262000 59000	181000 40600	1.45		1600000 359000	EE275105	275158
266.700 10.5000	406.400 16.0000	69.850 2.7500	1010000 228000	0.40	1.49	262000 59000	181000 40600	1.45		1600000 359000	EE275105	275160
266.700 10.5000	444.500 17.5000	120.650 4.7500	1820000 410000	0.58	1.04	473000 106000	466000 105000	1.01		3520000 791000	H852849	H852810

⁽¹⁾Based on 1×10^6 revolutions L_{10} life, for the ISO life-calculation method.

⁽²⁾Consult your Timken engineer for instructions on use or review the Timken Engineering Manual on timken.com/catalogs.

⁽³⁾Based on 90×10^6 revolutions L_{10} life, for The Timken Company life-calculation method. C_{90} and C_{a90} are radial and thrust values.

Bearing Dimensions											Geometry Factors			Bearing Weight
Width B	Width C	Eff. Ctr. a ⁽⁴⁾	Shaft			Housing			Cage		G ₁	G ₂	C _g	
			Max Shaft Fillet Radius R ⁽⁵⁾	Backing Shoulder Dia. d _a	Backing Shoulder Dia. d _b	Max Housing Fillet Radius r ⁽⁵⁾	Backing Shoulder Dia. D _a	Backing Shoulder Dia. D _b	A _a ⁽⁶⁾	A _b ⁽⁷⁾				
mm in.	mm in.	mm in.	mm in.	mm in.	mm in.	mm in.	mm in.	mm in.	mm in.	mm in.				kg lbs.
120.650 4.7500	92.075 3.6250	-31.0 -1.22	6.4 0.25	290.0 11.42	299.0 11.77	6.4 0.25	450.5 17.74	444.0 17.48	18.6 0.73	4.0 0.16	2247.3	171.9	0.1664	95.98 211.61
28.575 1.1250	25.400 1.0000	20.3 0.80	1.5 0.06	275.0 10.83	275.0 10.83	1.5 0.06	315.0 12.40	312.0 12.28	1.3 0.05	1.3 0.05	1028.2	496.4	0.1676	5.19 11.43
57.150 2.2500	44.450 1.7500	5.1 0.20	3.5 0.14	279.0 10.98	283.0 11.14	3.3 0.13	342.9 13.50	335.0 13.19	5.8 0.23	3.4 0.14	1554.1	212.2	0.1536	15.48 34.14
62.000 2.4409	44.450 1.7500	5.1 0.20	3.5 0.14	280.0 11.02	284.0 11.18	3.3 0.13	342.9 13.50	335.0 13.19	4.2 0.16	1.7 0.07	1411.7	193.7	0.1484	15.54 34.27
33.470 1.3177	25.400 1.0000	19.3 0.76	1.5 0.06	276.0 10.87	277.0 10.91	1.5 0.06	315.0 12.40	312.0 12.28	1.0 0.04	-0.9 -0.03	916.6	595.1	0.1613	5.41 11.92
33.470 1.3177	25.400 1.0000	19.6 0.77	1.5 0.06	275.0 10.83	277.0 10.91	1.5 0.06	315.0 12.40	312.0 12.28	0.5 0.02	-0.8 -0.03	993.2	480.2	0.1656	5.37 11.82
22.225 0.8750	15.875 0.6250	21.1 0.83	1.5 0.06	275.0 10.83	277.0 10.91	1.5 0.06	312.0 12.28	310.0 12.20	1.7 0.06	1.9 0.08	906.8	658.2	0.1567	3.36 7.40
28.575 1.1250	25.400 1.0000	20.3 0.80	1.5 0.06	277.0 10.91	277.0 10.91	1.5 0.06	315.0 12.40	312.0 12.28	1.3 0.05	1.3 0.05	1028.2	496.4	0.1676	4.91 10.80
34.039 1.3401	25.400 1.0000	19.3 0.76	1.5 0.06	276.0 10.87	278.0 10.94	1.5 0.06	315.0 12.40	312.0 12.28	1.0 0.04	-1.5 -0.06	916.6	595.1	0.1613	5.43 11.98
33.470 1.3177	25.400 1.0000	19.6 0.77	1.5 0.06	275.0 10.83	277.0 10.91	1.5 0.06	315.0 12.40	312.0 12.28	0.5 0.02	-0.8 -0.03	993.2	480.2	0.1656	5.35 11.79
57.150 2.2500	44.450 1.7500	5.1 0.20	3.5 0.14	281.0 11.06	285.0 11.22	3.3 0.13	342.9 13.50	335.0 13.19	5.8 0.23	3.4 0.14	1554.1	212.2	0.1536	14.92 32.91
57.150 2.2500	44.450 1.7500	5.1 0.20	10.5 0.41	281.0 11.06	299.0 11.77	3.3 0.13	342.9 13.50	335.0 13.19	5.8 0.23	3.4 0.14	1554.1	212.2	0.1536	14.79 32.61
57.150 2.2500	44.450 1.7500	5.1 0.20	9.7 0.38	281.0 11.06	297.0 11.69	3.3 0.13	342.9 13.50	335.0 13.19	5.8 0.23	3.4 0.14	1554.1	212.2	0.1536	14.81 32.66
69.850 2.7500	50.005 1.9687	2.5 0.10	6.4 0.25	287.0 11.30	296.0 11.65	6.4 0.25	378.1 14.89	366.0 14.41	14.4 0.56	3.3 0.13	1451.8	201.3	0.1555	26.36 58.13
69.850 2.7500	46.038 1.8125	2.5 0.10	6.4 0.25	287.0 11.30	296.0 11.65	6.4 0.25	378.1 14.89	371.0 14.61	14.4 0.56	3.3 0.13	1451.8	201.3	0.1555	27.75 61.18
69.850 2.7500	46.038 1.8125	2.5 0.10	6.4 0.25	287.0 11.30	296.0 11.65	6.4 0.25	378.5 14.90	373.0 14.69	14.4 0.56	3.3 0.13	1451.8	201.3	0.1555	28.60 63.07
117.475 4.6250	88.900 3.5000	-0.5 -0.02	6.4 0.25	296.9 11.69	315.0 12.40	6.4 0.25	422.3 16.63	390.0 15.35	19.2 0.75	4.2 0.17	2254.5	171.3	0.2040	72.39 159.61

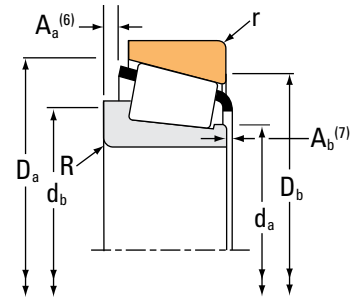
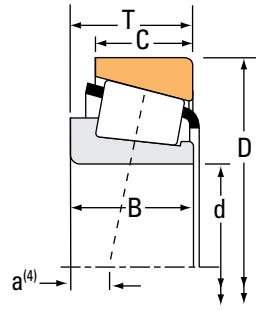
⁽⁴⁾Negative value indicates effective center inside cone (inner-ring) backface.
⁽⁵⁾These maximum fillet radii will be cleared by the bearing corners.
⁽⁶⁾Negative value indicates cage extends beyond cone (inner-ring) backface.
⁽⁷⁾Negative value indicates cage that does not extend beyond cone (inner-ring) front face.

Continued on next page.

TAPERED ROLLER BEARINGS

SINGLE-ROW • TYPE TS

TYPE TS



Bearing Dimensions			Load Ratings							Part Number		
Bore d	O.D. D	Width T	Dynamic ⁽¹⁾		Factors ⁽²⁾		Dynamic ⁽³⁾		Factors ⁽²⁾	Static	Inner	Outer
			C ₁	e	Y	C ₉₀	C _{a90}	K	C ₀			
mm in.	mm in.	mm in.	N lbf			N lbf	N lbf			N lbf		
269.875 10.6250	381.000 15.0000	74.612 2.9375	1150000 258000	0.33	1.80	298000 67000	170000 38100	1.76		2030000 455000	M252349	M252310
269.875 10.6250	381.000 15.0000	74.612 2.9375	1260000 283000	0.33	1.80	326000 73200	185000 41700	1.76		2030000 455000	M252349H	M252310X
273.050 10.7500	393.700 15.5000	73.817 2.9062	1010000 228000	0.40	1.49	262000 59000	181000 40600	1.45		1600000 359000	EE275108	275155
273.050 10.7500	403.225 15.8750	69.850 2.7500	1010000 228000	0.40	1.49	262000 59000	181000 40600	1.45		1600000 359000	EE275108	275158
273.050 10.7500	406.400 16.0000	69.850 2.7500	1010000 228000	0.40	1.49	262000 59000	181000 40600	1.45		1600000 359000	EE275108	275160
275.000 10.8268	352.425 13.8750	36.513 1.4375	306000 68700	0.54	1.11	79200 17800	73100 16400	1.08		664000 149000	L853048	L853010W
276.225 10.8750	352.425 13.8750	36.512 1.4375	333000 74900	0.54	1.11	86300 19400	79600 17900	1.08		750000 169000	L853049	L853010
279.400 11.0000	317.500 12.5000	24.384 0.9600	162000 36500	0.35	1.73	42100 9460	24900 5610	1.69		467000 105000	LL352149	LL352110
279.400 11.0000	317.500 12.5000	24.384 0.9600	162000 36500	0.35	1.73	42100 9460	24900 5610	1.69		467000 105000	KLL352149	KLL352110
279.400 11.0000	374.650 14.7500	47.625 1.8750	520000 117000	0.40	1.49	135000 30300	92700 20800	1.45		1150000 258000	L555233	L555210
279.400 11.0000	469.900 18.5000	95.250 3.7500	1610000 363000	0.38	1.59	418000 94000	271000 60800	1.55		2350000 527000	EE722110	722185
279.400 11.0000	488.950 19.2500	120.650 4.7500	2420000 544000	0.31	1.92	628000 141000	336000 75600	1.87		3310000 744000	EE295110	295193
279.982 11.0229	380.009 14.9610	65.088 2.5625	722000 162000	0.43	1.39	187000 42100	138000 31100	1.35		1720000 387000	LM654642	LM654611
280.000 11.0236	406.400 16.0000	69.850 2.7500	868000 195000	0.39	1.55	225000 50600	149000 33400	1.51		1660000 374000	EE128112	128160
280.192 11.0312	400.050 15.7500	52.388 2.0625	690000 155000	0.41	1.47	179000 40200	125000 28100	1.43		1180000 266000	EE101103	101575
280.192 11.0312	406.400 16.0000	52.388 2.0625	690000 155000	0.41	1.47	179000 40200	125000 28100	1.43		1180000 266000	EE101103	101600
280.192 11.0312	406.400 16.0000	69.850 2.7500	868000 195000	0.39	1.55	225000 50600	149000 33400	1.51		1660000 374000	EE128111	128160

⁽¹⁾Based on 1 x 10⁶ revolutions L₁₀ life, for the ISO life-calculation method.

⁽²⁾Consult your Timken engineer for instructions on use or review the Timken Engineering Manual on timken.com/catalogs.

⁽³⁾Based on 90 x 10⁶ revolutions L₁₀ life, for The Timken Company life-calculation method. C₉₀ and C_{a90} are radial and thrust values.

Bearing Dimensions											Geometry Factors			Bearing Weight
Width B	Width C	Eff. Ctr. a ⁽⁴⁾	Shaft			Housing			Cage		G ₁	G ₂	C _g	
			Max Shaft Fillet Radius R ⁽⁵⁾	Backing Shoulder Dia. d _a	mm in.	Max Housing Fillet Radius r ⁽⁵⁾	Backing Shoulder Dia. D _a	mm in.	A _a ⁽⁶⁾	A _b ⁽⁷⁾				
mm in.	mm in.	mm in.	mm in.	mm in.	mm in.	mm in.	mm in.	mm in.	mm in.	mm in.			kg lbs.	
74.612 2.9375	57.150 2.2500	-6.6 -0.26	6.4 0.25	287.0 11.30	296.0 11.65	3.3 0.13	364.0 14.32	356.0 14.02	8.3 0.32	3.6 0.14	1839.2	226.1	0.1588	25.22 55.57
74.612 2.9375	57.150 2.2500	-6.6 -0.26	6.4 0.25	288.0 11.34	297.0 11.69	3.3 0.13	364.0 14.32	356.0 14.02	8.3 0.32	3.5 0.14	1839.2	226.1	0.1588	25.48 56.18
69.850 2.7500	50.005 1.9687	2.5 0.10	6.4 0.25	291.0 11.46	301.0 11.85	6.4 0.25	378.1 14.89	366.0 14.41	14.4 0.56	3.3 0.13	1451.8	201.3	0.1555	24.98 55.07
69.850 2.7500	46.038 1.8125	2.5 0.10	6.4 0.25	291.0 11.46	301.0 11.85	6.4 0.25	378.1 14.89	371.0 14.61	14.4 0.56	3.3 0.13	1451.8	201.3	0.1555	26.37 58.12
69.850 2.7500	46.038 1.8125	2.5 0.10	6.4 0.25	291.0 11.46	301.0 11.85	6.4 0.25	378.5 14.90	373.0 14.69	14.4 0.56	3.3 0.13	1451.8	201.3	0.1555	27.22 60.01
40.000 1.5748	23.812 0.9375	35.1 1.38	3.5 0.14	287.0 11.30	292.0 11.50	3.3 0.13	342.0 13.46	332.0 13.07	4.2 0.16	0.3 0.01	970.3	322.9	0.1471	8.32 18.34
34.925 1.3750	23.812 0.9375	35.1 1.38	3.5 0.14	288.0 11.34	293.0 11.54	3.3 0.13	342.0 13.46	332.0 13.07	5.9 0.23	3.5 0.14	1057.3	350.4	0.1517	7.72 17.03
24.384 0.9600	18.288 0.7200	20.3 0.80	1.5 0.06	286.0 11.26	288.0 11.34	1.5 0.06	312.0 12.28	309.0 12.17	1.8 0.07	2.1 0.09	1131.2	795.2	0.1688	2.57 5.66
24.384 0.9600	18.288 0.7200	20.3 0.80	1.5 0.06	286.0 11.26	288.0 11.34	1.5 0.06	312.0 12.28	309.0 12.17	1.8 0.07	2.1 0.09	1131.2	795.2	0.1688	2.57 5.66
47.625 1.8750	34.925 1.3750	17.5 0.69	3.5 0.14	296.0 11.65	300.0 11.81	3.3 0.13	362.0 14.25	355.0 13.98	5.5 0.21	2.4 0.10	1476.9	368.2	0.1553	13.90 30.65
93.662 3.6875	69.850 2.7500	-7.6 -0.30	9.7 0.38	314.0 12.36	321.0 12.64	3.3 0.13	432.9 17.04	430.0 16.93	16.8 0.66	0.5 0.02	1894.4	142.6	0.1669	59.62 131.44
120.650 4.7500	92.075 3.6250	-31.0 -1.22	1.3 0.05	304.0 11.97	303.0 11.93	6.4 0.25	450.5 17.74	444.0 17.48	19.4 0.76	3.5 0.14	2247.3	171.9	0.1664	88.48 195.09
65.088 2.5625	49.212 1.9375	11.4 0.45	3.5 0.14	298.0 11.73	302.0 11.89	3.3 0.13	368.0 14.49	356.0 14.02	7.9 0.31	0.8 0.03	1916.4	265.6	0.1744	20.75 45.73
67.673 2.6643	53.975 2.1250	6.6 0.26	6.4 0.25	307.0 12.09	308.0 12.13	3.3 0.13	384.0 15.12	378.0 14.88	8.2 0.32	0.9 0.04	1622.7	240.4	0.1592	27.08 59.71
50.211 1.9768	34.925 1.3750	15.7 0.62	6.8 0.27	307.0 12.09	309.0 12.17	3.3 0.13	376.0 14.80	374.0 14.72	7.7 0.30	5.3 0.21	1380.2	226.7	0.1527	18.44 40.64
50.211 1.9768	34.925 1.3750	15.7 0.62	6.8 0.27	307.0 12.09	309.0 12.17	3.3 0.13	376.0 14.80	377.0 14.84	7.7 0.30	5.3 0.21	1380.2	226.7	0.1527	19.53 43.06
67.673 2.6643	53.975 2.1250	6.6 0.26	6.8 0.27	307.0 12.09	309.0 12.17	3.3 0.13	384.0 15.12	378.0 14.88	8.2 0.32	0.9 0.04	1622.7	240.4	0.1592	27.01 59.56

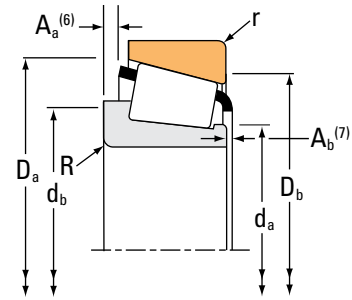
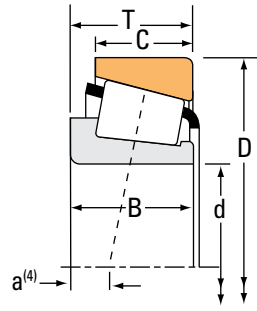
⁽⁴⁾Negative value indicates effective center inside cone (inner-ring) backface.
⁽⁵⁾These maximum fillet radii will be cleared by the bearing corners.
⁽⁶⁾Negative value indicates cage extends beyond cone (inner-ring) backface.
⁽⁷⁾Negative value indicates cage that does not extend beyond cone (inner-ring) front face.

Continued on next page.

TAPERED ROLLER BEARINGS

SINGLE-ROW • TYPE TS

TYPE TS



Bearing Dimensions			Load Ratings							Part Number		
Bore d	O.D. D	Width T	Dynamic ⁽¹⁾		Factors ⁽²⁾		Dynamic ⁽³⁾		Factors ⁽²⁾	Static	Inner	Outer
			C ₁	e	Y	C ₉₀	C _{a90}	K	C ₀			
mm in.	mm in.	mm in.	N lbf			N lbf	N lbf			N lbf		
280.192 11.0312	406.400 16.0000	69.850 2.7500	924000 208000	0.39	1.55	240000 53900	158000 35600	1.51		1820000 409000	EE128110	128160
280.192 11.0312	409.981 16.1410	69.850 2.7500	868000 195000	0.39	1.55	225000 50600	149000 33400	1.51		1660000 374000	EE128111	128161
280.192 11.0312	409.981 16.1410	69.850 2.7500	924000 208000	0.39	1.55	240000 53900	158000 35600	1.51		1820000 409000	EE128110	128161
285.750 11.2500	354.012 13.9375	33.338 1.3125	258000 58000	0.49	1.22	66800 15000	56300 12600	1.19		596000 134000	545112	545139
285.750 11.2500	358.775 14.1250	33.338 1.3125	258000 58000	0.49	1.22	66800 15000	56300 12600	1.19		596000 134000	545112	545141
285.750 11.2500	380.898 14.9960	65.088 2.5625	722000 162000	0.43	1.39	187000 42100	138000 31100	1.35		1720000 387000	LM654649	LM654610
285.750 11.2500	469.900 18.5000	81.770 3.2193	1510000 339000	0.29	2.05	391000 88000	196000 44000	2.00		1990000 447000	EE921124	921850
285.750 11.2500	476.250 18.7500	81.770 3.2193	1510000 339000	0.29	2.05	391000 88000	196000 44000	2.00		1990000 447000	EE921124	921875
288.925 11.3750	406.400 16.0000	77.788 3.0625	1190000 267000	0.34	1.77	308000 69300	179000 40100	1.73		2520000 567000	M255449	M255410
288.925 11.3750	406.400 16.0000	77.788 3.0625	1360000 307000	0.34	1.77	354000 79500	205000 46000	1.73		2520000 567000	M255449H	M255410
289.975 11.4163	393.700 15.5000	50.800 2.0000	586000 132000	0.36	1.67	152000 34200	93500 21000	1.63		1310000 295000	L357040	L357010
292.100 11.5000	374.650 14.7500	47.625 1.8750	520000 117000	0.40	1.49	135000 30300	92700 20800	1.45		1150000 258000	L555249	L555210
292.100 11.5000	393.700 15.5000	63.500 2.5000	548000 123000	0.61	0.98	142000 31900	148000 33300	0.96		997000 224000	84115	84155
292.100 11.5000	469.900 18.5000	95.250 3.7500	1610000 363000	0.38	1.59	418000 94000	271000 60800	1.55		2350000 527000	EE722115	722185
292.100 11.5000	520.700 20.5000	107.950 4.2500	1950000 439000	0.33	1.83	506000 114000	284000 63900	1.78		3330000 749000	EE224115	224204
292.100 11.5000	558.800 22.0000	136.525 5.3750	3090000 695000	0.40	1.52	802000 180000	542000 122000	1.48		4100000 923000	EE790114	790221
292.100 11.5000	558.800 22.0000	136.525 5.3750	3090000 695000	0.40	1.52	802000 180000	542000 122000	1.48		4100000 923000	EE790116	790221

⁽¹⁾Based on 1 x 10⁶ revolutions L₁₀ life, for the ISO life-calculation method.

⁽²⁾Consult your Timken engineer for instructions on use or review the Timken Engineering Manual on timken.com/catalogs.

⁽³⁾Based on 90 x 10⁶ revolutions L₁₀ life, for The Timken Company life-calculation method. C₉₀ and C_{a90} are radial and thrust values.

Bearing Dimensions											Geometry Factors			Bearing Weight
Width B	Width C	Eff. Ctr. a ⁽⁴⁾	Shaft			Housing			Cage		G ₁	G ₂	C _g	
			Max Shaft Fillet Radius R ⁽⁵⁾	Backing Shoulder Dia. d _a	Shoulder Dia. d _b	Max Housing Fillet Radius r ⁽⁵⁾	Backing Shoulder Dia. D _a	Shoulder Dia. D _b	A _a ⁽⁶⁾	A _b ⁽⁷⁾				
mm in.	mm in.	mm in.	mm in.	mm in.	mm in.	mm in.	mm in.	mm in.	mm in.	mm in.				kg lbs.
67.673 2.6643	53.975 2.1250	6.6 0.26	6.8 0.27	307.0 12.09	309.0 12.17	3.3 0.13	384.0 15.12	378.0 14.88	6.8 0.27	1.5 0.06	1727.7	255.2	0.1628	27.97 61.67
67.673 2.6643	53.975 2.1250	6.6 0.26	6.8 0.27	307.0 12.09	309.0 12.17	3.3 0.13	384.0 15.12	379.0 14.92	8.2 0.32	0.9 0.04	1622.7	240.4	0.1592	27.98 61.70
67.673 2.6643	53.975 2.1250	6.6 0.26	6.8 0.27	307.0 12.09	309.0 12.17	3.3 0.13	384.0 15.12	379.0 14.92	6.8 0.27	1.5 0.06	1727.7	255.2	0.1628	28.94 63.81
31.750 1.2500	22.225 0.8750	32.8 1.29	3.5 0.14	298.0 11.73	302.0 11.89	3.3 0.13	345.0 13.58	338.0 13.31	5.6 0.22	2.9 0.12	1015.9	545.5	0.1446	6.28 13.84
31.750 1.2500	22.225 0.8750	32.8 1.29	3.5 0.14	298.0 11.73	302.0 11.89	3.3 0.13	345.0 13.58	340.0 13.39	5.6 0.22	2.9 0.12	1015.9	545.5	0.1446	6.74 14.86
65.088 2.5625	49.212 1.9375	11.4 0.45	3.5 0.14	302.0 11.89	306.0 12.05	3.3 0.13	368.0 14.49	356.0 14.02	7.9 0.31	0.8 0.03	1916.4	265.6	0.1744	19.62 43.23
80.569 3.1720	57.150 2.2500	-13.5 -0.53	9.7 0.38	309.0 12.17	325.0 12.80	3.3 0.13	440.0 17.32	439.0 17.28	16.2 0.63	6.0 0.24	1732.1	200.0	0.1481	48.70 107.38
80.569 3.1720	57.150 2.2500	-13.5 -0.53	9.7 0.38	309.0 12.17	325.0 12.80	3.3 0.13	442.0 17.40	442.0 17.40	16.2 0.63	6.0 0.24	1732.1	200.0	0.1481	50.81 112.03
77.788 3.0625	60.325 2.3750	-4.1 -0.16	6.4 0.25	310.0 12.20	316.0 12.44	3.3 0.13	387.9 15.27	379.0 14.92	5.8 0.22	4.0 0.16	2301.3	287.6	0.1722	30.80 67.90
77.788 3.0625	60.325 2.3750	-4.1 -0.16	6.4 0.25	311.0 12.24	317.0 12.48	3.3 0.13	387.9 15.27	379.0 14.92	5.8 0.22	4.0 0.16	2301.3	287.6	0.1722	30.90 68.15
50.800 2.0000	38.100 1.5000	12.7 0.50	6.4 0.25	308.0 12.13	318.0 12.52	3.3 0.13	380.0 14.96	374.0 14.72	5.6 0.22	2.0 0.08	1753.3	301.0	0.1585	17.19 37.89
47.625 1.8750	34.925 1.3750	17.5 0.69	3.5 0.14	305.0 12.01	309.0 12.17	3.3 0.13	362.0 14.25	355.0 13.98	5.5 0.21	2.4 0.10	1476.9	368.2	0.1553	11.78 25.97
50.800 2.0000	44.450 1.7500	36.6 1.44	3.5 0.14	309.0 12.17	313.0 12.32	6.4 0.25	378.0 14.88	363.0 14.29	13.8 0.54	2.8 0.11	1227.4	302.3	0.1660	17.86 39.37
93.662 3.6875	69.850 2.7500	-7.6 -0.30	9.7 0.38	324.0 12.76	330.0 12.99	3.3 0.13	432.9 17.04	430.0 16.93	16.8 0.66	0.5 0.02	1894.4	142.6	0.1669	55.13 121.54
107.950 4.2500	76.200 3.0000	-19.8 -0.78	6.4 0.25	321.0 12.64	331.0 13.03	6.4 0.25	470.0 18.50	468.0 18.43	15.3 0.60	3.3 0.13	2630.1	228.6	0.1780	92.50 203.91
136.525 5.3750	98.425 3.8750	-24.4 -0.96	6.4 0.25	329.0 12.95	335.0 13.19	6.4 0.25	514.2 20.24	501.0 19.72	20.0 0.78	7.3 0.29	2663.9	170.3	0.1898	139.90 308.45
136.525 5.3750	98.425 3.8750	-24.4 -0.96	19.8 0.78	329.0 12.95	362.0 14.25	6.4 0.25	514.2 20.24	501.0 19.72	20.0 0.78	7.3 0.29	2663.9	170.3	0.1898	138.58 305.52

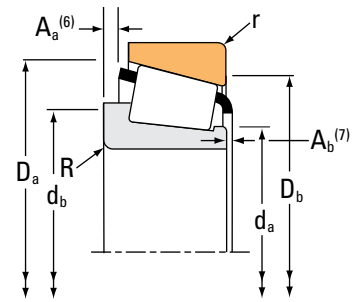
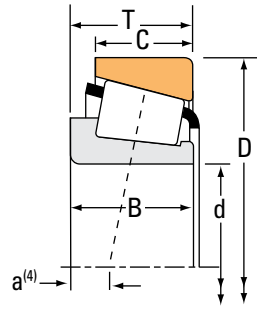
⁽⁴⁾Negative value indicates effective center inside cone (inner-ring) backface.
⁽⁵⁾These maximum fillet radii will be cleared by the bearing corners.
⁽⁶⁾Negative value indicates cage extends beyond cone (inner-ring) backface.
⁽⁷⁾Negative value indicates cage that does not extend beyond cone (inner-ring) front face.

Continued on next page.

TAPERED ROLLER BEARINGS

SINGLE-ROW • TYPE TS

TYPE TS



Bearing Dimensions			Load Ratings							Part Number		
Bore d	O.D. D	Width T	Dynamic ⁽¹⁾		Factors ⁽²⁾		Dynamic ⁽³⁾		Factors ⁽²⁾	Static	Inner	Outer
			C ₁	e	Y	C ₉₀	C _{a90}	K	C ₀			
mm in.	mm in.	mm in.	N lbf			N lbf	N lbf			N lbf		
298.450 11.7500	431.800 17.0000	69.850 2.7500	613000 138000	0.44	1.37	159000 35700	119000 26800	1.33		1280000 288000	EE111175	111700
298.450 11.7500	444.500 17.5000	63.500 2.5000	887000 199000	0.38	1.59	230000 51700	149000 33400	1.55		1390000 312000	EE291175	291750
299.975 11.8100	495.300 19.5000	141.288 5.5625	2870000 645000	0.33	1.80	744000 167000	423000 95200	1.76		5650000 1270000	HH258248	HH258210
300.038 11.8125	422.275 16.6250	82.550 3.2500	1300000 292000	0.34	1.78	336000 75600	194000 43600	1.73		2770000 622000	HM256849	HM256810
304.800 12.0000	393.700 15.5000	50.800 2.0000	586000 132000	0.36	1.67	152000 34200	93500 21000	1.63		1310000 295000	L357049	L357010
304.800 12.0000	406.400 16.0000	63.500 2.5000	769000 173000	0.44	1.36	199000 44800	151000 33900	1.32		1740000 392000	LM757049	LM757010
304.800 12.0000	406.400 16.0000	63.500 2.5000	815000 183000	0.44	1.36	211000 47500	160000 35900	1.32		1740000 392000	LM757049AA	LM757010
304.800 12.0000	438.048 17.2460	76.200 3.0000	896000 201000	0.42	1.44	232000 52200	165000 37200	1.40		1780000 401000	EE129120X	129172
304.800 12.0000	444.500 17.5000	63.500 2.5000	887000 199000	0.38	1.59	230000 51700	149000 33400	1.55		1390000 312000	EE291201	291750
304.800 12.0000	444.500 17.5000	63.500 2.5000	887000 199000	0.38	1.59	230000 51700	149000 33400	1.55		1390000 312000	EE291201	291749
304.800 12.0000	495.300 19.5000	76.200 3.0000	1550000 348000	0.40	1.49	402000 90300	277000 62200	1.45		2090000 471000	EE941205	941950
304.800 12.0000	495.300 19.5000	76.200 3.0000	1550000 348000	0.40	1.49	402000 90300	277000 62200	1.45		2090000 471000	EE941205X	941950
304.800 12.0000	495.300 19.5000	95.250 3.7500	1690000 379000	0.40	1.49	437000 98300	301000 67700	1.45		2550000 573000	EE724120	724195
304.800 12.0000	495.300 19.5000	95.250 3.7500	1510000 339000	0.40	1.49	392000 88000	269000 60600	1.45		2650000 595000	EE724119	724195
304.800 12.0000	499.948 19.6830	101.600 4.0000	1340000 300000	1.17	0.51	346000 77900	695000 156000	0.50		1890000 424000	M959442	M959410
304.800 12.0000	558.800 22.0000	136.525 5.3750	3090000 695000	0.40	1.52	802000 180000	542000 122000	1.48		4100000 923000	EE790120	790221
304.800 12.0000	647.700 25.5000	139.700 5.5000	2350000 528000	0.87	0.69	609000 137000	903000 203000	0.67		3520000 790000	EE991201	992550

⁽¹⁾Based on 1×10^6 revolutions L_{10} life, for the ISO life-calculation method.

⁽²⁾Consult your Timken engineer for instructions on use or review the Timken Engineering Manual on timken.com/catalogs.

⁽³⁾Based on 90×10^6 revolutions L_{10} life, for The Timken Company life-calculation method. C_{90} and C_{a90} are radial and thrust values.

Bearing Dimensions											Geometry Factors			Bearing Weight
Width B	Width C	Eff. Ctr. a ⁽⁴⁾	Shaft			Housing			Cage		G ₁	G ₂	C _g	
			Max Shaft Fillet Radius R ⁽⁵⁾	Backing Shoulder Dia. d _a	mm in.	Max Housing Fillet Radius r ⁽⁵⁾	Backing Shoulder Dia. D _a	mm in.	A _a ⁽⁶⁾	A _b ⁽⁷⁾				
mm in.	mm in.	mm in.	mm in.	mm in.	mm in.	mm in.	mm in.	mm in.	mm in.	mm in.			kg lbs.	
58.738 2.3125	53.975 2.1250	16.3 0.64	6.4 0.25	319.0 12.56	328.0 12.91	3.3 0.13	406.2 15.99	401.0 15.79	15.3 0.60	2.2 0.09	1603.5	266.6	0.1640	28.48 62.78
61.912 2.4375	39.688 1.5625	7.6 0.30	8.0 0.31	320.0 12.60	332.0 13.07	1.5 0.06	415.0 16.34	416.0 16.38	11.4 0.45	7.1 0.28	1579.2	244.8	0.1557	29.47 64.98
141.288 5.5625	114.300 4.5000	-34.5 -1.36	6.4 0.25	332.0 13.07	342.0 13.46	6.4 0.25	467.0 18.40	448.0 17.64	10.6 0.42	7.7 0.31	3853.2	220.0	0.2048	110.43 243.46
82.550 3.2500	63.500 2.5000	-5.6 -0.22	6.4 0.25	319.0 12.56	328.0 12.91	3.3 0.13	403.0 15.88	394.0 15.51	7.4 0.29	3.6 0.14	2548.4	281.8	0.1779	35.46 78.17
50.800 2.0000	38.100 1.5000	12.7 0.50	6.4 0.25	319.0 12.56	329.0 12.95	3.3 0.13	380.0 14.96	374.0 14.72	5.6 0.22	2.0 0.08	1753.3	301.0	0.1585	14.43 31.80
63.500 2.5000	47.625 1.8750	16.3 0.64	6.4 0.25	322.0 12.68	331.0 13.03	3.3 0.13	393.0 15.47	380.0 14.96	6.9 0.27	2.5 0.10	1988.6	260.3	0.1775	21.61 47.63
63.500 2.5000	47.625 1.8750	16.3 0.64	12.7 0.50	322.0 12.68	344.0 13.54	3.3 0.13	393.0 15.47	380.0 14.96	6.9 0.27	2.5 0.10	1988.6	260.3	0.1775	21.44 47.25
76.992 3.0312	53.975 2.1250	7.4 0.29	6.4 0.25	328.0 12.91	334.0 13.15	4.8 0.19	411.4 16.20	406.0 15.98	14.9 0.59	-2.0 -0.07	1882.6	272.9	0.1711	33.07 72.90
61.912 2.4375	39.688 1.5625	7.6 0.30	8.0 0.31	324.0 12.76	337.0 13.27	1.5 0.06	415.0 16.34	416.0 16.38	11.4 0.45	7.1 0.28	1579.2	244.8	0.1557	28.01 61.76
61.912 2.4375	39.688 1.5625	7.6 0.30	8.0 0.31	324.0 12.76	337.0 13.27	3.3 0.13	415.0 16.34	415.0 16.34	11.4 0.45	7.1 0.28	1579.2	244.8	0.1557	27.96 61.65
74.612 2.9375	53.975 2.1250	9.1 0.36	6.4 0.25	329.0 12.95	339.0 13.35	3.3 0.13	462.7 18.22	459.0 18.07	10.2 0.40	6.0 0.24	1771.6	187.4	0.1657	51.58 113.70
77.866 3.0656	53.975 2.1250	9.1 0.36	6.4 0.25	332.0 13.07	339.0 13.35	3.3 0.13	462.7 18.22	459.0 18.07	10.2 0.40	2.7 0.11	1771.6	187.4	0.1657	52.27 115.23
92.075 3.6250	69.850 2.7500	-1.5 -0.06	16.0 0.63	330.0 12.99	359.0 14.13	6.4 0.25	458.9 18.07	450.0 17.72	17.3 0.68	2.3 0.09	2183.9	165.7	0.1783	62.67 138.16
92.075 3.6250	69.850 2.7500	-1.5 -0.06	16.0 0.63	330.0 12.99	359.0 14.13	6.4 0.25	458.9 18.07	450.0 17.72	14.3 0.56	4.9 0.20	2242.3	170.0	0.1800	65.74 144.92
79.375 3.1250	53.975 2.1250	105.4 4.15	6.4 0.25	344.0 13.54	353.0 13.90	6.4 0.25	481.1 18.94	438.0 17.24	*	*	1521.2	157.5	0.2137	65.25 143.84
136.525 5.3750	98.425 3.8750	-24.4 -0.96	1.3 0.05	335.0 13.19	335.0 13.19	6.4 0.25	514.2 20.24	501.0 19.72	20.0 0.78	7.3 0.29	2663.9	170.3	0.1898	133.72 294.82
120.650 4.7500	88.900 3.5000	55.1 2.17	13.5 0.53	360.0 14.17	384.0 15.12	13.5 0.53	587.0 23.11	546.0 21.50	26.0 1.02	23.0 0.91	2353.6	161.7	0.2299	190.66 420.35

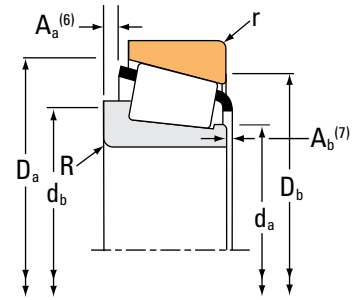
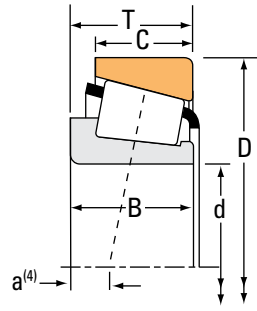
⁽⁴⁾Negative value indicates effective center inside cone (inner-ring) backface.
⁽⁵⁾These maximum fillet radii will be cleared by the bearing corners.
⁽⁶⁾Negative value indicates cage extends beyond cone (inner-ring) backface.
⁽⁷⁾Negative value indicates cage that does not extend beyond cone (inner-ring) front face.
^(*)Contact your Timken engineer for details.

Continued on next page.

TAPERED ROLLER BEARINGS

SINGLE-ROW • TYPE TS

TYPE TS



Bearing Dimensions			Load Ratings							Part Number		
Bore d	O.D. D	Width T	Dynamic ⁽¹⁾		Factors ⁽²⁾		Dynamic ⁽³⁾		Factors ⁽²⁾	Static	Inner	Outer
			C ₁	e	Y	C ₉₀	C _{a90}	K	C ₀			
mm in.	mm in.	mm in.	N lbf			N lbf	N lbf			N lbf		
305.054 12.0100	406.400 16.0000	63.500 2.5000	769000 173000	0.44	1.36	199000 44800	151000 33900	1.32		1740000 392000	LM757049A	LM757010
309.880 12.2000	501.650 19.7500	98.425 3.8750	2600000 585000	0.30	2.00	675000 152000	346000 77900	1.95		3770000 848000	HM161040	HM161012
312.738 12.3125	358.775 14.1250	22.225 0.8750	134000 30000	0.82	0.73	34700 7790	48900 11000	0.71		383000 86100	LL957049	LL957010
314.325 12.3750	495.300 19.5000	120.650 4.7500	1960000 440000	0.58	1.04	508000 114000	500000 113000	1.01		3950000 889000	H859049	H859010
317.500 12.5000	444.500 17.5000	63.500 2.5000	887000 199000	0.38	1.59	230000 51700	149000 33400	1.55		1390000 312000	EE291250	291750
317.500 12.5000	444.500 17.5000	63.500 2.5000	887000 199000	0.38	1.59	230000 51700	149000 33400	1.55		1390000 312000	EE291250	291749
317.500 12.5000	447.675 17.6250	85.725 3.3750	1680000 377000	0.33	1.79	435000 97800	249000 56000	1.74		3140000 706000	HM259049	HM259010
317.500 12.5000	447.675 17.6250	85.725 3.3750	1690000 380000	0.33	1.79	438000 98500	251000 56500	1.74		2790000 628000	HM259048	HM259010
317.500 12.5000	457.200 18.0000	66.675 2.6250	996000 224000	0.39	1.53	258000 58000	173000 38900	1.49		1660000 373000	EE201250	201800
317.500 12.5000	596.900 23.5000	136.525 5.3750	3310000 744000	0.42	1.42	858000 193000	620000 139000	1.38		4600000 1030000	EE720125	720236
317.500 12.5000	622.300 24.5000	147.638 5.8125	3160000 710000	0.94	0.64	819000 184000	1310000 295000	0.62		4130000 927000	H961649	H961610
317.500 12.5000	647.700 25.5000	139.700 5.5000	2350000 528000	0.87	0.69	609000 137000	903000 203000	0.67		3520000 790000	EE991251	992550
320.675 12.6250	406.400 16.0000	50.800 2.0000	572000 129000	0.41	1.47	148000 33400	104000 23300	1.43		1260000 282000	L558548	L558510
323.850 12.7500	381.000 15.0000	28.575 1.1250	244000 54800	0.44	1.36	63100 14200	47600 10700	1.33		672000 151000	LL758744	LL758715
323.850 12.7500	422.275 16.6250	58.738 2.3125	748000 168000	0.39	1.55	194000 43600	129000 29000	1.51		1570000 352000	LM559048	LM559010
325.438 12.8125	596.900 23.5000	136.525 5.3750	3310000 744000	0.42	1.42	858000 193000	620000 139000	1.38		4600000 1030000	EE720128	720236
329.870 12.9870	533.400 21.0000	76.200 3.0000	1730000 388000	0.33	1.80	448000 101000	255000 57300	1.76		2500000 562000	EE971298	972100

⁽¹⁾Based on 1 x 10⁶ revolutions L₁₀ life, for the ISO life-calculation method.

⁽²⁾Consult your Timken engineer for instructions on use or review the Timken Engineering Manual on timken.com/catalogs.

⁽³⁾Based on 90 x 10⁶ revolutions L₁₀ life, for The Timken Company life-calculation method. C₉₀ and C_{a90} are radial and thrust values.

Bearing Dimensions											Geometry Factors			Bearing Weight
Width B	Width C	Eff. Ctr. a ⁽⁴⁾	Shaft			Housing			Cage		G ₁	G ₂	C _g	
			Max Shaft Fillet Radius R ⁽⁵⁾	Backing Shoulder Dia. d _a	mm in.	Max Housing Fillet Radius r ⁽⁵⁾	Backing Shoulder Dia. D _a	mm in.	A _a ⁽⁶⁾	A _b ⁽⁷⁾				
mm in.	mm in.	mm in.	mm in.	mm in.	mm in.	mm in.	mm in.	mm in.	mm in.	mm in.			kg lbs.	
63.500 2.5000	47.625 1.8750	16.3 0.64	6.4 0.25	325.0 12.80	331.0 13.03	3.3 0.13	393.0 15.47	380.0 14.96	6.9 0.27	2.5 0.10	1988.6	260.3	0.1775	21.53 47.45
98.425 3.8750	79.375 3.1250	11.9 0.47	6.4 0.25	339.0 13.35	348.0 13.70	3.3 0.13	475.0 18.70	468.0 18.43	3.6 0.14	6.7 0.27	3153.6	239.4	0.1837	77.17 170.15
20.638 0.8125	14.288 0.5625	79.5 3.13	2.3 0.09	322.0 12.68	325.0 12.80	1.5 0.06	354.0 13.94	346.0 13.62	3.1 0.12	2.1 0.09	990.0	808.0	0.2091	3.06 6.75
119.062 4.6875	88.900 3.5000	8.4 0.33	6.4 0.25	344.8 13.57	361.0 14.21	6.4 0.25	473.0 18.62	439.0 17.28	17.7 0.70	3.7 0.15	2954.9	250.1	0.2225	83.09 183.19
61.912 2.4375	39.688 1.5625	7.6 0.30	8.0 0.31	334.0 13.15	346.0 13.62	1.5 0.06	415.0 16.34	416.0 16.38	11.4 0.45	7.1 0.28	1579.2	244.8	0.1557	24.99 55.11
61.912 2.4375	39.688 1.5625	7.6 0.30	8.0 0.31	334.0 13.15	346.0 13.62	3.3 0.13	415.0 16.34	415.0 16.34	11.4 0.45	7.1 0.28	1579.2	244.8	0.1557	24.94 55.01
85.725 3.3750	68.262 2.6875	-4.8 -0.19	3.5 0.14	337.0 13.27	341.0 13.43	3.3 0.13	427.7 16.84	418.0 16.46	6.8 0.27	3.8 0.15	2944.6	303.9	0.1863	41.94 92.46
85.725 3.3750	68.262 2.6875	-4.8 -0.19	3.5 0.14	337.0 13.27	341.0 13.43	3.3 0.13	427.7 16.84	418.0 16.46	6.4 0.25	3.8 0.15	2711.5	280.9	0.1809	40.57 89.44
65.088 2.5625	42.862 1.6875	9.7 0.38	6.8 0.27	337.0 13.27	348.0 13.70	6.8 0.27	429.2 16.90	424.0 16.69	15.1 0.59	4.1 0.17	1880.1	284.2	0.1672	30.68 67.63
136.525 5.3750	98.425 3.8750	-16.8 -0.66	19.8 0.78	353.0 13.90	390.0 15.35	6.4 0.25	547.4 21.55	534.0 21.02	20.4 0.80	7.9 0.32	3159.0	183.3	0.2053	160.44 353.72
131.762 5.1875	82.550 3.2500	60.5 2.38	14.3 0.56	373.0 14.69	410.0 16.14	12.7 0.50	581.6 22.90	531.0 20.91	25.1 0.98	17.7 0.70	2502.7	149.1	0.2401	178.13 392.68
120.650 4.7500	88.900 3.5000	55.1 2.17	13.5 0.53	371.0 14.61	394.0 15.51	13.5 0.53	587.0 23.11	546.0 21.50	26.0 1.02	22.7 0.90	2353.6	161.7	0.2299	184.79 407.40
55.562 2.1875	38.100 1.5000	21.1 0.83	3.3 0.13	338.0 13.31	338.0 13.31	3.3 0.13	396.0 15.59	387.0 15.24	3.1 0.12	0.1 0.01	1727.9	396.2	0.1641	14.96 32.97
28.575 1.1250	20.638 0.8125	35.1 1.38	3.5 0.14	333.0 13.11	339.0 13.35	3.3 0.13	373.1 14.69	365.0 14.37	2.8 0.11	2.5 0.10	1500.1	792.5	0.2007	5.30 11.69
63.500 2.5000	44.450 1.7500	15.0 0.59	3.3 0.13	341.8 13.46	343.0 13.50	3.3 0.13	409.0 16.10	400.0 15.75	5.0 0.20	0.5 0.02	1926.3	352.6	0.1679	18.42 40.59
136.525 5.3750	98.425 3.8750	-16.8 -0.66	6.4 0.25	359.0 14.13	369.0 14.53	6.4 0.25	547.4 21.55	534.0 21.02	20.4 0.80	8.2 0.33	3159.0	183.3	0.2053	156.18 344.32
76.200 3.0000	50.800 2.0000	3.8 0.15	4.8 0.19	357.0 14.06	364.0 14.33	3.3 0.13	501.0 19.72	501.0 19.72	10.2 0.40	5.0 0.20	2433.2	282.5	0.1730	61.43 135.43

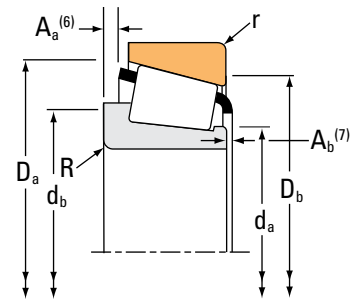
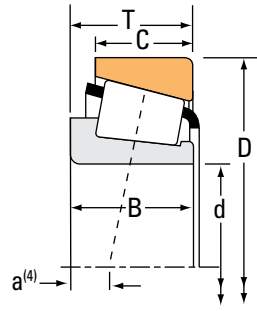
(4) Negative value indicates effective center inside cone (inner-ring) backface.
 (5) These maximum fillet radii will be cleared by the bearing corners.
 (6) Negative value indicates cage extends beyond cone (inner-ring) backface.
 (7) Negative value indicates cage that does not extend beyond cone (inner-ring) front face.

Continued on next page.

TAPERED ROLLER BEARINGS

SINGLE-ROW • TYPE TS

TYPE TS



Bearing Dimensions			Load Ratings							Part Number		
Bore d	O.D. D	Width T	Dynamic ⁽¹⁾		Factors ⁽²⁾		Dynamic ⁽³⁾		Factors ⁽²⁾	Static	Inner	Outer
			C ₁	e	Y	C ₉₀	C _{a90}	K	C ₀			
mm in.	mm in.	mm in.	N lbf			N lbf	N lbf			N lbf		
329.895 12.9880	415.925 16.3750	47.625 1.8750	485000 109000	0.50	1.20	126000 28300	107000 24100	1.17		1180000 266000	L860049A	L860010
330.200 13.0000	415.925 16.3750	47.625 1.8750	485000 109000	0.50	1.20	126000 28300	107000 24100	1.17		1180000 266000	L860049	L860010
330.200 13.0000	415.925 16.3750	47.625 1.8750	485000 109000	0.50	1.20	126000 28300	107000 24100	1.17		1180000 266000	L860048	L860010
330.200 13.0000	469.900 18.5000	60.325 2.3750	628000 141000	0.50	1.20	163000 36600	140000 31400	1.17		1110000 250000	EE161300	161850
330.200 13.0000	482.600 19.0000	60.325 2.3750	628000 141000	0.50	1.20	163000 36600	140000 31400	1.17		1110000 250000	EE161300	161900
330.200 13.0000	482.600 19.0000	66.675 2.6250	1030000 231000	0.42	1.44	266000 59900	190000 42700	1.40		1770000 398000	EE203130	203190
330.200 13.0000	482.600 19.0000	85.725 3.3750	1250000 281000	0.39	1.54	324000 72900	217000 48700	1.49		2320000 523000	EE526130	526190
330.200 13.0000	482.600 19.0000	85.725 3.3750	1250000 281000	0.39	1.54	324000 72900	217000 48700	1.49		2320000 523000	EE526132	526190
333.000 13.1102	415.925 16.3750	47.625 1.8750	485000 109000	0.50	1.20	126000 28300	107000 24100	1.17		1180000 266000	L860049AA	L860010
333.375 13.1250	469.900 18.5000	90.488 3.5625	1600000 360000	0.33	1.79	415000 93200	238000 53400	1.74		3460000 777000	HM261049	HM261010
338.138 13.3125	403.225 15.8750	33.338 1.3125	301000 67700	0.42	1.44	78100 17600	55600 12500	1.40		827000 186000	LL660749A	LL660711
342.900 13.5000	450.850 17.7500	66.675 2.6250	1120000 251000	0.35	1.70	289000 65000	174000 39200	1.66		2210000 497000	LM361649	LM361610
342.900 13.5000	457.098 17.9960	66.675 2.6250	823000 185000	0.71	0.84	213000 48000	260000 58500	0.82		1940000 436000	LM961548	LM961510
342.900 13.5000	457.098 17.9960	68.262 2.6875	823000 185000	0.71	0.84	213000 48000	260000 58500	0.82		1940000 436000	LM961548	LM961511
342.900 13.5000	533.400 21.0000	76.200 3.0000	1730000 388000	0.33	1.80	448000 101000	255000 57300	1.76		2500000 562000	EE971354	972100
343.154 13.5100	450.850 17.7500	66.675 2.6250	1120000 251000	0.35	1.70	289000 65000	174000 39200	1.66		2210000 497000	LM361649A	LM361610
346.075 13.6250	469.900 18.5000	60.325 2.3750	628000 141000	0.50	1.20	163000 36600	140000 31400	1.17		1110000 250000	EE161363	161850

⁽¹⁾Based on 1 x 10⁶ revolutions L₁₀ life, for the ISO life-calculation method.

⁽²⁾Consult your Timken engineer for instructions on use or review the Timken Engineering Manual on timken.com/catalogs.

⁽³⁾Based on 90 x 10⁶ revolutions L₁₀ life, for The Timken Company life-calculation method. C₉₀ and C_{a90} are radial and thrust values.

Bearing Dimensions											Geometry Factors			Bearing Weight
Width B	Width C	Eff. Ctr. a ⁽⁴⁾	Shaft			Housing			Cage		G ₁	G ₂	C _g	
			Max Shaft Fillet Radius R ⁽⁵⁾	Backing Shoulder Dia. d _a	Shoulder Dia. d _b	Max Housing Fillet Radius r ⁽⁵⁾	Backing Shoulder Dia. D _a	Shoulder Dia. D _b	A _a ⁽⁶⁾	A _b ⁽⁷⁾				
mm in.	mm in.	mm in.	mm in.	mm in.	mm in.	mm in.	mm in.	mm in.	mm in.	mm in.				kg lbs.
47.625 1.8750	34.925 1.3750	35.3 1.39	3.5 0.14	345.0 13.58	349.0 13.74	3.3 0.13	402.0 15.83	394.0 15.51	7.3 0.28	0.2 0.01	1823.3	479.1	0.1774	14.11 31.11
47.625 1.8750	34.925 1.3750	35.3 1.39	3.5 0.14	345.0 13.58	349.0 13.74	3.3 0.13	402.0 15.83	394.0 15.51	7.3 0.28	0.2 0.01	1823.3	479.1	0.1774	14.03 30.94
47.625 1.8750	34.925 1.3750	35.3 1.39	12.7 0.50	345.0 13.58	367.0 14.45	3.3 0.13	402.0 15.83	394.0 15.51	7.3 0.28	0.2 0.01	1823.3	479.1	0.1774	13.41 29.57
55.562 2.1875	38.100 1.5000	33.8 1.33	7.0 0.28	356.0 14.02	367.0 14.45	6.4 0.25	455.0 17.91	445.0 17.52	14.4 0.56	3.9 0.16	1730.8	299.6	0.1741	28.82 63.54
55.562 2.1875	38.100 1.5000	33.8 1.33	7.0 0.28	356.0 14.02	367.0 14.45	6.4 0.25	455.0 17.91	451.0 17.76	14.4 0.56	3.9 0.16	1730.8	299.6	0.1741	31.65 69.77
63.500 2.5000	44.450 1.7500	16.3 0.64	6.8 0.27	354.0 13.94	364.0 14.33	6.8 0.27	456.1 17.96	449.0 17.68	15.4 0.60	5.9 0.23	2138.1	336.0	0.1778	35.82 78.97
80.167 3.1562	60.325 2.3750	4.8 0.19	6.4 0.25	351.0 13.82	360.0 14.17	3.3 0.13	454.0 17.87	449.0 17.68	14.5 0.57	3.1 0.13	2283.3	287.2	0.1790	45.20 99.65
80.167 3.1562	60.325 2.3750	4.8 0.19	3.3 0.13	351.0 13.82	354.0 13.94	3.3 0.13	454.0 17.87	449.0 17.68	14.5 0.57	3.1 0.13	2283.3	287.2	0.1790	45.21 99.67
47.625 1.8750	34.925 1.3750	35.3 1.39	3.5 0.14	347.0 13.66	351.0 13.82	3.3 0.13	402.0 15.83	394.0 15.51	7.3 0.28	0.2 0.01	1823.3	479.1	0.1774	13.56 29.88
90.488 3.5625	71.438 2.8125	-6.1 -0.24	6.4 0.25	358.0 14.09	363.0 14.29	3.3 0.13	449.0 17.69	439.0 17.28	7.7 0.30	3.3 0.13	3306.8	324.3	0.1935	48.69 107.32
33.338 1.3125	26.988 1.0625	33.3 1.31	3.3 0.13	350.0 13.78	353.0 13.90	3.3 0.13	394.0 15.51	386.0 15.20	1.9 0.07	1.0 0.04	1790.4	757.8	0.2095	7.63 16.83
66.675 2.6250	52.388 2.0625	8.9 0.35	8.5 0.33	359.0 14.13	373.0 14.69	3.5 0.14	435.0 17.13	425.0 16.73	4.7 0.18	4.9 0.20	2732.7	432.9	0.1833	27.00 59.52
63.500 2.5000	46.038 1.8125	56.4 2.22	3.3 0.13	363.0 14.29	367.0 14.45	3.3 0.13	443.1 17.44	423.0 16.65	12.6 0.49	4.9 0.20	2281.5	300.4	0.2146	28.11 61.97
63.500 2.5000	47.625 1.8750	56.4 2.22	3.3 0.13	363.0 14.29	367.0 14.45	3.3 0.13	443.1 17.44	423.0 16.65	12.6 0.49	4.9 0.20	2281.5	300.4	0.2146	28.57 63.00
76.200 3.0000	50.800 2.0000	3.8 0.15	4.8 0.19	367.0 14.45	373.0 14.69	3.3 0.13	501.0 19.72	501.0 19.72	10.2 0.40	5.0 0.20	2433.2	282.5	0.1730	57.32 126.38
66.675 2.6250	52.388 2.0625	8.9 0.35	8.5 0.33	363.0 14.29	373.0 14.69	3.5 0.14	435.0 17.13	425.0 16.73	4.7 0.18	4.9 0.20	2732.7	432.9	0.1833	26.91 59.32
55.562 2.1875	38.100 1.5000	33.8 1.33	7.0 0.28	368.0 14.49	379.0 14.92	6.4 0.25	455.0 17.91	445.0 17.52	14.4 0.56	3.9 0.16	1730.8	299.6	0.1741	25.15 55.44

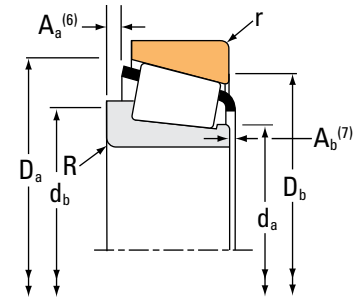
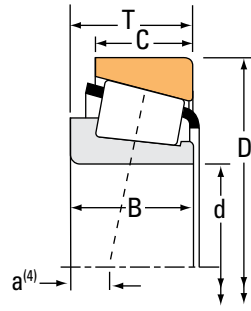
⁽⁴⁾Negative value indicates effective center inside cone (inner-ring) backface.
⁽⁵⁾These maximum fillet radii will be cleared by the bearing corners.
⁽⁶⁾Negative value indicates cage extends beyond cone (inner-ring) backface.
⁽⁷⁾Negative value indicates cage that does not extend beyond cone (inner-ring) front face.

Continued on next page.

TAPERED ROLLER BEARINGS

SINGLE-ROW • TYPE TS

TYPE TS



Bearing Dimensions			Load Ratings							Part Number		
Bore d	O.D. D	Width T	Dynamic ⁽¹⁾		Factors ⁽²⁾		Dynamic ⁽³⁾		Factors ⁽²⁾	Static	Inner	Outer
			C ₁	e	Y	C ₉₀	C _{a90}	K	C ₀			
mm in.	mm in.	mm in.	N lbf			N lbf	N lbf			N lbf		
346.075 13.6250	482.600 19.0000	60.325 2.3750	628000 141000	0.50	1.20	163000 36600	140000 31400	1.17		1110000 250000	EE161363	161900
346.075 13.6250	482.600 19.0000	66.675 2.6250	1030000 231000	0.42	1.44	266000 59900	190000 42700	1.40		1770000 398000	EE203136	203190
346.075 13.6250	482.600 19.0000	66.675 2.6250	1030000 231000	0.42	1.44	266000 59900	190000 42700	1.40		1770000 398000	EE203137	203190
346.075 13.6250	488.950 19.2500	95.250 3.7500	1730000 388000	0.33	1.79	448000 101000	257000 57700	1.74		3760000 845000	HM262749	HM262710
346.075 13.6250	488.950 19.2500	95.250 3.7500	1860000 419000	0.33	1.79	483000 109000	277000 62300	1.74		3440000 774000	HM262748	HM262710
346.075 13.6250	546.100 21.5000	93.662 3.6875	2690000 604000	0.24	2.46	696000 157000	291000 65500	2.39		3990000 897000	HM164646	HM164615
349.250 13.7500	501.650 19.7500	90.488 3.5625	1350000 304000	0.37	1.63	350000 78700	220000 49500	1.59		2780000 626000	EE333137	333197
354.012 13.9375	469.900 18.5000	60.325 2.3750	548000 123000	0.50	1.20	142000 31900	122000 27400	1.17		1110000 250000	EE161394	161850
354.012 13.9375	482.600 19.0000	60.325 2.3750	548000 123000	0.50	1.20	142000 31900	122000 27400	1.17		1110000 250000	EE161394	161900
355.600 14.0000	444.500 17.5000	60.325 2.3750	733000 165000	0.31	1.95	190000 42700	100000 22500	1.90		1970000 444000	L163149	L163110
355.600 14.0000	469.900 18.5000	60.325 2.3750	628000 141000	0.50	1.20	163000 36600	140000 31400	1.17		1110000 250000	EE161400	161850
355.600 14.0000	482.600 19.0000	60.325 2.3750	628000 141000	0.50	1.20	163000 36600	140000 31400	1.17		1110000 250000	EE161400	161900
355.600 14.0000	488.950 19.2500	60.325 2.3750	628000 141000	0.50	1.20	163000 36600	140000 31400	1.17		1110000 250000	EE161400	161925
355.600 14.0000	501.650 19.7500	74.612 2.9375	1050000 236000	0.44	1.36	273000 61300	206000 46200	1.33		1870000 420000	EE231400	231975
355.600 14.0000	501.650 19.7500	90.488 3.5625	1350000 304000	0.37	1.63	350000 78700	220000 49500	1.59		2780000 626000	EE333140	333197
355.600 14.0000	514.350 20.2500	74.612 2.9375	1050000 236000	0.44	1.36	273000 61300	206000 46200	1.33		1870000 420000	EE231400	232025
355.600 14.0000	673.100 26.5000	152.400 6.0000	3690000 830000	0.38	1.60	957000 215000	616000 138000	1.55		6140000 1380000	EE121140	121265

⁽¹⁾Based on 1 x 10⁶ revolutions L₁₀ life, for the ISO life-calculation method.

⁽²⁾Consult your Timken engineer for instructions on use or review the Timken Engineering Manual on timken.com/catalogs.

⁽³⁾Based on 90 x 10⁶ revolutions L₁₀ life, for The Timken Company life-calculation method. C₉₀ and C_{a90} are radial and thrust values.

Bearing Dimensions											Geometry Factors			Bearing Weight
Width B	Width C	Eff. Ctr. a ⁽⁴⁾	Shaft			Housing			Cage		G ₁	G ₂	C _g	
			Max Shaft Fillet Radius R ⁽⁵⁾	Backing Shoulder Dia. d _a	Backing Shoulder Dia. d _b	Max Housing Fillet Radius r ⁽⁵⁾	Backing Shoulder Dia. D _a	Backing Shoulder Dia. D _b	A _a ⁽⁶⁾	A _b ⁽⁷⁾				
mm in.	mm in.	mm in.	mm in.	mm in.	mm in.	mm in.	mm in.	mm in.	mm in.	mm in.				kg lbs.
55.562 2.1875	38.100 1.5000	33.8 1.33	7.0 0.28	368.0 14.49	379.0 14.92	6.4 0.25	455.0 17.91	451.0 17.76	14.4 0.56	3.9 0.16	1730.8	299.6	0.1741	27.98 61.67
63.500 2.5000	44.450 1.7500	16.3 0.64	6.8 0.27	366.0 14.41	376.0 14.80	6.8 0.27	456.1 17.96	449.0 17.68	15.4 0.60	5.9 0.23	2138.1	336.0	0.1778	31.62 69.72
63.500 2.5000	44.450 1.7500	16.3 0.64	12.7 0.50	366.0 14.41	388.0 15.28	6.8 0.27	456.1 17.96	449.0 17.68	15.4 0.60	5.9 0.23	2138.1	336.0	0.1778	31.12 68.62
95.250 3.7500	74.612 2.9375	-6.4 -0.25	6.4 0.25	367.0 14.45	377.0 14.84	3.3 0.13	467.0 18.39	456.0 17.95	8.5 0.33	3.5 0.14	3646.2	341.8	0.1999	55.50 122.37
95.250 3.7500	74.612 2.9375	-6.4 -0.25	6.4 0.25	367.0 14.45	377.0 14.84	3.3 0.13	467.0 18.39	456.0 17.95	9.3 0.36	3.0 0.12	3430.8	322.6	0.1956	54.07 119.21
95.250 3.7500	76.200 3.0000	-15.5 -0.61	6.4 0.25	373.0 14.69	383.0 15.08	3.3 0.13	507.0 19.96	507.0 19.96	2.0 0.08	7.5 0.30	3841.3	316.9	0.1827	85.75 189.06
84.138 3.3125	69.850 2.7500	3.6 0.14	6.4 0.25	372.0 14.65	382.0 15.04	3.3 0.13	478.2 18.83	470.0 18.50	12.0 0.47	3.1 0.12	3037.5	334.7	0.1928	52.79 116.40
55.562 2.1875	38.100 1.5000	33.8 1.33	7.0 0.28	374.0 14.72	385.0 15.16	6.4 0.25	455.0 17.91	445.0 17.52	14.4 0.56	3.9 0.16	1730.8	299.6	0.1741	23.24 51.25
55.562 2.1875	38.100 1.5000	33.8 1.33	7.0 0.28	374.0 14.72	385.0 15.16	6.4 0.25	455.0 17.91	451.0 17.76	14.4 0.56	3.9 0.16	1730.8	299.6	0.1741	26.07 57.48
60.325 2.3750	47.625 1.8750	7.1 0.28	3.5 0.14	370.0 14.57	374.0 14.72	3.3 0.13	430.0 16.93	422.0 16.61	5.2 0.20	2.3 0.09	3207.7	621.3	0.1838	20.64 45.51
55.562 2.1875	38.100 1.5000	33.8 1.33	7.0 0.28	375.0 14.76	386.0 15.20	6.4 0.25	455.0 17.91	445.0 17.52	14.4 0.56	3.9 0.16	1730.8	299.6	0.1741	22.86 50.40
55.562 2.1875	38.100 1.5000	33.8 1.33	7.0 0.28	375.0 14.76	386.0 15.20	6.4 0.25	455.0 17.91	451.0 17.76	14.4 0.56	3.9 0.16	1730.8	299.6	0.1741	25.69 56.63
55.562 2.1875	38.100 1.5000	33.8 1.33	7.0 0.28	375.0 14.76	386.0 15.20	6.4 0.25	455.0 17.91	453.0 17.83	14.4 0.56	3.9 0.16	1730.8	299.6	0.1741	27.13 59.80
66.675 2.6250	50.800 2.0000	19.6 0.77	6.4 0.25	379.0 14.92	388.0 15.28	3.3 0.13	481.1 18.94	472.0 18.58	18.9 0.74	6.0 0.24	2386.0	366.8	0.1874	39.16 86.35
84.138 3.3125	69.850 2.7500	3.6 0.14	6.4 0.25	377.0 14.84	387.0 15.24	3.3 0.13	478.2 18.83	470.0 18.50	12.0 0.47	3.1 0.12	3037.5	334.7	0.1928	50.47 111.29
66.675 2.6250	50.800 2.0000	19.6 0.77	6.4 0.25	379.0 14.92	388.0 15.28	3.3 0.13	481.1 18.94	478.0 18.82	18.9 0.74	6.0 0.24	2386.0	366.8	0.1874	43.13 95.08
152.400 6.0000	114.300 4.5000	-24.4 -0.96	16.0 0.63	396.0 15.59	425.0 16.73	6.4 0.25	611.8 24.09	603.0 23.74	21.8 0.85	6.7 0.27	4540.6	230.6	0.2231	235.18 518.47

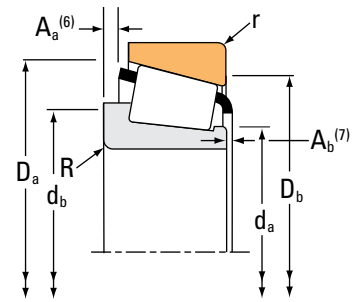
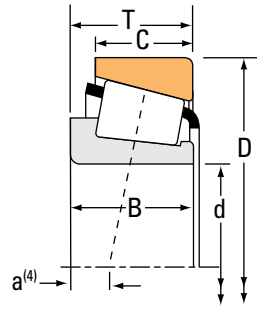
(4) Negative value indicates effective center inside cone (inner-ring) backface.
 (5) These maximum fillet radii will be cleared by the bearing corners.
 (6) Negative value indicates cage extends beyond cone (inner-ring) backface.
 (7) Negative value indicates cage that does not extend beyond cone (inner-ring) front face.

Continued on next page.

TAPERED ROLLER BEARINGS

SINGLE-ROW • TYPE TS

TYPE TS



Bearing Dimensions			Load Ratings							Part Number		
Bore d	O.D. D	Width T	Dynamic ⁽¹⁾		Factors ⁽²⁾		Dynamic ⁽³⁾		Factors ⁽²⁾	Static	Inner	Outer
			C ₁	e	Y	C ₉₀	C _{a90}	K	C ₀			
mm in.	mm in.	mm in.	N lbf			N lbf	N lbf			N lbf		
360.400 14.1890	510.000 20.0787	88.000 3.4646	1870000 421000	0.31	1.95	485000 109000	255000 57300	1.90		3550000 798000	NP771673	NP725758
361.950 14.2500	406.400 16.0000	23.812 0.9375	198000 44500	0.40	1.49	51300 11500	35300 7940	1.45		574000 129000	LL562749	LL562710
368.249 14.4980	523.875 20.6250	101.600 4.0000	2270000 511000	0.33	1.80	589000 132000	335000 75400	1.76		4340000 977000	HM265049	HM265010
368.300 14.5000	596.900 23.5000	95.250 3.7500	1770000 399000	0.41	1.45	460000 103000	326000 73400	1.41		3030000 680000	EE181453	182350
368.300 14.5000	609.600 24.0000	142.875 5.6250	2970000 668000	0.36	1.68	770000 173000	470000 106000	1.64		5380000 1210000	EE321145	321240
368.300 14.5000	622.300 24.5000	142.875 5.6250	2970000 668000	0.36	1.68	770000 173000	470000 106000	1.64		5380000 1210000	EE321145	321245
371.475 14.6250	501.650 19.7500	74.612 2.9375	1050000 236000	0.44	1.36	273000 61300	206000 46200	1.33		1870000 420000	EE231462	231975
371.475 14.6250	514.350 20.2500	74.612 2.9375	1050000 236000	0.44	1.36	273000 61300	206000 46200	1.33		1870000 420000	EE231462	232025
374.650 14.7500	431.800 17.0000	28.575 1.1250	254000 57100	0.33	1.80	65800 14800	37500 8430	1.76		745000 167000	LL264648	LL264610
374.650 14.7500	522.288 20.5625	85.725 3.3750	1390000 313000	0.39	1.56	360000 81000	238000 53500	1.51		2950000 663000	LM565943	LM565910
377.825 14.8750	508.000 20.0000	63.500 2.5000	755000 170000	0.53	1.13	196000 44000	179000 40200	1.10		1480000 332000	EE192148	192200
377.825 14.8750	522.288 20.5625	85.725 3.3750	1390000 313000	0.39	1.56	360000 81000	238000 53500	1.51		2950000 663000	LM565946	LM565910
381.000 15.0000	479.425 18.8750	49.212 1.9375	594000 133000	0.50	1.21	154000 34600	130000 29300	1.18		1380000 311000	L865547	L865512
381.000 15.0000	479.425 18.8750	49.212 1.9375	594000 133000	0.50	1.21	154000 34600	130000 29300	1.18		1380000 311000	L865548	L865512
381.000 15.0000	508.000 20.0000	63.500 2.5000	755000 170000	0.53	1.13	196000 44000	179000 40200	1.10		1480000 332000	EE192150	192200
381.000 15.0000	522.288 20.5625	85.725 3.3750	1390000 313000	0.39	1.56	360000 81000	238000 53500	1.51		2950000 663000	LM565949	LM565910
381.000 15.0000	546.100 21.5000	104.775 4.1250	2460000 553000	0.33	1.80	638000 143000	363000 81700	1.76		4730000 1060000	HM266447	HM266410

⁽¹⁾Based on 1 x 10⁶ revolutions L₁₀ life, for the ISO life-calculation method.

⁽²⁾Consult your Timken engineer for instructions on use or review the Timken Engineering Manual on timken.com/catalogs.

⁽³⁾Based on 90 x 10⁶ revolutions L₁₀ life, for The Timken Company life-calculation method. C₉₀ and C_{a90} are radial and thrust values.

Bearing Dimensions											Geometry Factors			Bearing Weight
Width B	Width C	Eff. Ctr. a ⁽⁴⁾	Shaft			Housing			Cage		G ₁	G ₂	C _g	
			Max Shaft Fillet Radius R ⁽⁵⁾	Backing Shoulder Dia. d _a	Backing Shoulder Dia. d _b	Max Housing Fillet Radius r ⁽⁵⁾	Backing Shoulder Dia. D _a	Backing Shoulder Dia. D _b	A _a ⁽⁶⁾	A _b ⁽⁷⁾				
mm in.	mm in.	mm in.	mm in.	mm in.	mm in.	mm in.	mm in.	mm in.	mm in.	mm in.				kg lbs.
103.000 4.0551	72.000 2.8346	-4.1 -0.16	6.0 0.24	382.0 15.04	391.0 15.39	2.5 0.10	481.0 18.94	473.0 18.62	4.9 0.19	4.9 0.19	3826.7	375.8	0.1968	58.62 129.23
23.812 0.9375	17.462 0.6875	37.8 1.49	2.3 0.09	371.0 14.61	372.0 14.65	1.5 0.06	401.0 15.79	396.0 15.59	1.0 0.04	2.4 0.10	1673.0	1063.8	0.2005	3.69 8.13
101.600 4.0000	79.375 3.1250	-8.4 -0.33	6.4 0.25	394.0 15.51	400.0 15.75	6.4 0.25	499.0 19.63	487.0 19.17	9.2 0.36	3.7 0.15	4297.3	412.9	0.2106	69.20 152.56
92.075 3.6250	60.325 2.3750	9.4 0.37	9.7 0.38	402.0 15.83	415.0 16.34	6.4 0.25	552.0 21.73	552.0 21.73	18.5 0.72	6.8 0.27	2961.8	271.9	0.1984	90.79 200.17
139.700 5.5000	111.125 4.3750	-23.6 -0.93	8.0 0.31	404.0 15.91	413.0 16.26	6.4 0.25	571.0 22.48	555.0 21.85	21.1 0.83	4.9 0.20	4401.5	304.6	0.2173	156.49 345.01
139.700 5.5000	111.125 4.3750	-23.6 -0.93	8.0 0.31	404.0 15.91	413.0 16.26	6.4 0.25	571.0 22.48	561.0 22.09	21.1 0.83	4.9 0.20	4401.5	304.6	0.2173	167.16 368.54
66.675 2.6250	50.800 2.0000	19.6 0.77	6.4 0.25	390.0 15.35	400.0 15.75	3.3 0.13	481.1 18.94	472.0 18.58	18.9 0.74	6.0 0.24	2386.0	366.8	0.1874	34.43 75.91
66.675 2.6250	50.800 2.0000	19.6 0.77	6.4 0.25	390.0 15.35	400.0 15.75	3.3 0.13	481.1 18.94	478.0 18.82	18.9 0.74	6.0 0.24	2386.0	366.8	0.1874	38.40 84.65
28.575 1.1250	20.638 0.8125	27.9 1.10	3.5 0.14	384.0 15.12	389.0 15.31	3.3 0.13	424.0 16.69	417.0 16.42	1.9 0.07	3.0 0.12	2155.1	1055.1	0.2055	6.08 13.41
84.138 3.3125	61.912 2.4375	8.9 0.35	6.4 0.25	397.0 15.63	407.0 16.02	3.3 0.13	499.5 19.67	493.0 19.41	12.3 0.48	3.2 0.13	3379.9	375.8	0.2028	51.91 114.42
58.738 2.3125	38.100 1.5000	39.4 1.55	6.4 0.25	398.0 15.67	408.0 16.06	3.3 0.13	482.0 18.98	478.0 18.82	17.9 0.70	4.0 0.16	2288.0	398.1	0.1951	30.27 66.73
84.138 3.3125	61.912 2.4375	8.9 0.35	6.4 0.25	399.0 15.71	409.0 16.10	3.3 0.13	499.5 19.67	493.0 19.41	12.3 0.48	3.2 0.13	3379.9	375.8	0.2028	50.67 111.69
47.625 1.8750	34.925 1.3750	42.9 1.69	6.4 0.25	395.0 15.55	407.0 16.02	3.3 0.13	465.0 18.31	456.0 17.95	6.6 0.26	2.8 0.11	2256.6	529.8	0.1897	18.56 40.92
47.625 1.8750	34.925 1.3750	42.9 1.69	12.7 0.50	395.0 15.55	419.0 16.50	3.3 0.13	465.0 18.31	456.0 17.95	6.6 0.26	2.8 0.11	2256.6	529.8	0.1897	18.31 40.37
58.738 2.3125	38.100 1.5000	39.4 1.55	6.4 0.25	400.0 15.75	410.0 16.14	3.3 0.13	482.0 18.98	478.0 18.82	17.9 0.70	4.0 0.16	2288.0	398.1	0.1951	29.40 64.81
84.138 3.3125	61.912 2.4375	8.9 0.35	6.4 0.25	402.0 15.83	411.0 16.18	3.3 0.13	499.5 19.67	493.0 19.41	12.3 0.48	3.2 0.13	3379.9	375.8	0.2028	49.47 109.05
104.775 4.1250	82.550 3.2500	-7.1 -0.28	6.4 0.25	405.0 15.94	415.0 16.34	6.4 0.25	520.0 20.47	507.0 19.96	8.8 0.34	4.9 0.20	4760.1	301.5	0.2178	79.35 174.93

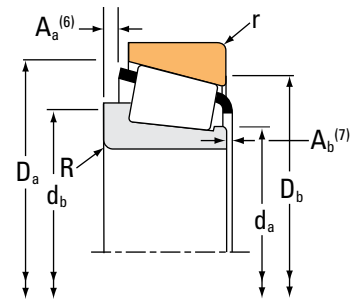
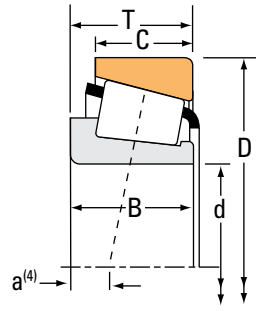
(4) Negative value indicates effective center inside cone (inner-ring) backface.
 (5) These maximum fillet radii will be cleared by the bearing corners.
 (6) Negative value indicates cage extends beyond cone (inner-ring) backface.
 (7) Negative value indicates cage that does not extend beyond cone (inner-ring) front face.

Continued on next page.

TAPERED ROLLER BEARINGS

SINGLE-ROW • TYPE TS

TYPE TS



Bearing Dimensions			Load Ratings							Part Number			
Bore d	O.D. D	Width T	Dynamic ⁽¹⁾		Factors ⁽²⁾		Dynamic ⁽³⁾		Factors ⁽²⁾		Static C ₀	Inner	Outer
			C ₁	e	Y	C ₉₀	C _{a90}	K	N	N			
mm in.	mm in.	mm in.	N lbf			N lbf	N lbf		N lbf				
381.000 15.0000	546.100 21.5000	104.775 4.1250	2270000 510000	0.33	1.80	588000 132000	335000 75200	1.76	4210000 946000		HM266446	HM266410	
381.000 15.0000	590.550 23.2500	114.300 4.5000	2860000 642000	0.33	1.80	740000 166000	421000 94800	1.76	5550000 1250000		M268730	M268710	
384.175 15.1250	441.325 17.3750	28.575 1.1250	232000 52300	0.34	1.76	60300 13500	35100 7890	1.72	667000 150000		LL365348	LL365310	
384.175 15.1250	546.100 21.5000	104.774 4.1250	2270000 510000	0.33	1.80	588000 132000	335000 75200	1.76	4210000 946000		HM266448	HM266410	
384.175 15.1250	546.100 21.5000	104.775 4.1250	2460000 553000	0.33	1.80	638000 143000	363000 81700	1.76	4730000 1060000		HM266449	HM266410	
385.762 15.1875	514.350 20.2500	82.550 3.2500	1350000 304000	0.42	1.43	351000 78900	251000 56500	1.40	3160000 710000		LM665949	LM665910	
387.248 15.2460	546.100 21.5000	87.312 3.4375	1870000 420000	0.42	1.44	484000 109000	346000 77800	1.40	3940000 886000		M667935	M667911	
393.700 15.5000	546.100 21.5000	76.200 3.0000	1090000 244000	0.48	1.26	282000 63300	230000 51600	1.23	2010000 451000		EE234154	234215	
396.875 15.6250	546.100 21.5000	76.200 3.0000	1090000 244000	0.48	1.26	282000 63300	230000 51600	1.23	2010000 451000		EE234156	234215	
396.875 15.6250	558.800 22.0000	65.088 2.5625	1090000 244000	0.48	1.26	282000 63300	230000 51600	1.23	2010000 451000		EE234156	234220	
400.000 15.7480	676.000 26.6142	152.400 6.0000	3770000 847000	0.79	0.76	976000 219000	1320000 298000	0.74	6470000 1450000		NP741069	NP263541	
403.225 15.8750	460.375 18.1250	28.575 1.1250	230000 51700	0.40	1.49	59600 13400	41000 9210	1.45	708000 159000		LL566848	LL566810	
406.400 16.0000	508.000 20.0000	61.912 2.4375	859000 193000	0.37	1.64	223000 50100	139000 31300	1.60	2230000 502000		L467549	L467510	
406.400 16.0000	546.100 21.5000	76.200 3.0000	1090000 244000	0.48	1.26	282000 63300	230000 51600	1.23	2010000 451000		EE234160	234215	
406.400 16.0000	546.100 21.5000	76.200 3.0000	1090000 244000	0.48	1.26	282000 63300	230000 51600	1.23	2010000 451000		EE234160A	234215X	
406.400 16.0000	546.100 21.5000	87.312 3.4375	1870000 420000	0.42	1.44	484000 109000	346000 77800	1.40	3940000 886000		M667944	M667911	
406.400 16.0000	549.275 21.6250	85.725 3.3750	1430000 322000	0.41	1.47	371000 83500	259000 58200	1.43	3130000 704000		LM567949	LM567910	

⁽¹⁾Based on 1 x 10⁶ revolutions L₁₀ life, for the ISO life-calculation method.

⁽²⁾Consult your Timken engineer for instructions on use or review the Timken Engineering Manual on timken.com/catalogs.

⁽³⁾Based on 90 x 10⁶ revolutions L₁₀ life, for The Timken Company life-calculation method. C₉₀ and C_{a90} are radial and thrust values.

Bearing Dimensions											Geometry Factors			Bearing Weight
Width B	Width C	Eff. Ctr. a ⁽⁴⁾	Shaft			Housing			Cage		G ₁	G ₂	C _g	
			Max Shaft Fillet Radius R ⁽⁵⁾	Backing Shoulder Dia. d _a	mm in.	Max Housing Fillet Radius r ⁽⁵⁾	Backing Shoulder Dia. D _a	mm in.	A _a ⁽⁶⁾	A _b ⁽⁷⁾				
mm in.	mm in.	mm in.	mm in.	mm in.	mm in.	mm in.	mm in.	mm in.	mm in.	mm in.			kg lbs.	
104.775 4.1250	82.550 3.2500	-7.1 -0.28	6.4 0.25	405.0 15.94	415.0 16.34	6.4 0.25	520.0 20.47	507.0 19.96	9.0 0.35	5.5 0.22	4383.4	278.7	0.2116	76.11 167.79
114.300 4.5000	88.900 3.5000	-9.4 -0.37	6.4 0.25	415.0 16.34	425.0 16.73	6.4 0.25	562.4 22.14	548.9 21.61	10.6 0.41	6.0 0.24	5754.9	420.9	0.2319	118.82 261.95
28.575 1.1250	20.638 0.8125	30.0 1.18	3.5 0.14	393.0 15.47	398.0 15.67	3.3 0.13	433.0 17.05	427.0 16.81	1.4 0.05	3.2 0.13	2056.5	1165.0	0.2033	6.23 13.74
104.775 4.1250	82.550 3.2500	-7.1 -0.28	6.4 0.25	407.0 16.02	417.0 16.42	6.4 0.25	520.0 20.47	507.0 19.96	9.0 0.35	5.5 0.22	4383.4	278.7	0.2116	74.41 164.05
104.775 4.1250	82.550 3.2500	-7.1 -0.28	6.4 0.25	407.0 16.02	417.0 16.42	6.4 0.25	520.0 20.47	507.0 19.96	8.8 0.34	4.9 0.20	4760.1	301.5	0.2178	77.78 171.48
82.550 3.2500	63.500 2.5000	16.3 0.64	6.4 0.25	406.0 15.98	415.0 16.34	3.3 0.13	495.0 19.49	482.0 18.98	9.4 0.37	2.9 0.12	3743.4	480.0	0.2155	45.18 99.61
87.312 3.4375	68.262 2.6875	17.8 0.70	6.4 0.25	414.0 16.30	424.0 16.69	6.4 0.25	526.7 20.74	510.0 20.08	8.0 0.31	2.7 0.11	4639.7	498.9	0.2316	65.33 144.04
61.120 2.4063	55.562 2.1875	35.6 1.40	6.4 0.25	416.0 16.38	426.0 16.77	6.4 0.25	515.6 20.30	504.0 19.84	13.8 0.54	6.1 0.24	2782.9	448.6	0.2018	44.77 98.69
61.120 2.4063	55.562 2.1875	35.6 1.40	6.4 0.25	418.0 16.46	428.0 16.85	6.4 0.25	515.6 20.30	504.0 19.84	13.8 0.54	6.1 0.24	2782.9	448.6	0.2018	43.83 96.61
61.120 2.4063	44.450 1.7500	35.6 1.40	6.4 0.25	418.0 16.46	428.0 16.85	6.4 0.25	516.0 20.31	516.0 20.31	13.8 0.54	6.1 0.24	2782.9	448.6	0.2018	43.25 95.34
148.000 5.8268	103.000 4.0551	54.1 2.13	6.4 0.25	448.0 17.64	481.0 18.94	6.4 0.25	642.0 25.28	591.0 23.27	21.4 0.84	11.3 0.45	4979.1	257.9	0.2897	215.02 474.07
28.575 1.1250	20.638 0.8125	41.4 1.63	3.5 0.14	414.0 16.30	418.0 16.46	3.3 0.13	452.0 17.80	445.0 17.52	2.0 0.08	2.0 0.08	2302.0	1585.3	0.2225	6.40 14.11
61.912 2.4375	47.625 1.8750	20.3 0.80	3.3 0.13	423.0 16.65	426.0 16.77	3.3 0.13	492.0 19.37	483.0 19.02	6.1 0.24	2.8 0.11	3716.5	673.8	0.2038	27.06 59.66
61.120 2.4063	55.562 2.1875	35.6 1.40	6.4 0.25	425.0 16.73	435.0 17.13	6.4 0.25	515.6 20.30	504.0 19.84	13.8 0.54	6.1 0.24	2782.9	448.6	0.2018	41.06 90.51
61.120 2.4063	55.562 2.1875	35.6 1.40	6.8 0.27	425.0 16.73	435.0 17.13	6.8 0.27	515.6 20.30	504.0 19.84	13.8 0.54	6.1 0.24	2782.9	448.6	0.2018	41.23 90.89
87.312 3.4375	68.262 2.6875	17.8 0.70	6.4 0.25	428.0 16.85	438.0 17.24	6.4 0.25	526.7 20.74	510.0 20.08	8.0 0.31	2.2 0.09	4639.7	498.9	0.2316	57.17 126.05
84.138 3.3125	61.912 2.4375	15.5 0.61	6.4 0.25	427.0 16.81	437.0 17.20	3.3 0.13	526.3 20.72	519.0 20.43	12.7 0.50	3.2 0.13	3796.2	424.8	0.2143	52.80 116.40

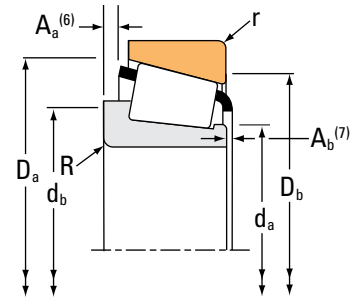
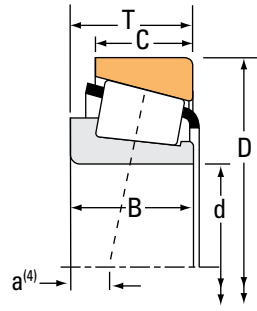
⁽⁴⁾Negative value indicates effective center inside cone (inner-ring) backface.
⁽⁵⁾These maximum fillet radii will be cleared by the bearing corners.
⁽⁶⁾Negative value indicates cage extends beyond cone (inner-ring) backface.
⁽⁷⁾Negative value indicates cage that does not extend beyond cone (inner-ring) front face.

Continued on next page.

TAPERED ROLLER BEARINGS

SINGLE-ROW • TYPE TS

TYPE TS



Bearing Dimensions			Load Ratings							Part Number		
Bore d	O.D. D	Width T	Dynamic ⁽¹⁾		Factors ⁽²⁾		Dynamic ⁽³⁾		Factors ⁽²⁾	Static	Inner	Outer
			C ₁	e	Y	C ₉₀	C _{a90}	K	C ₀			
mm in.	mm in.	mm in.	N lbf			N lbf	N lbf			N lbf		
406.400 16.0000	558.800 22.0000	65.088 2.5625	1090000 244000	0.48	1.26	282000 63300	230000 51600	1.23		2010000 451000	EE234160	234220
406.400 16.0000	574.675 22.6250	76.200 3.0000	1110000 249000	0.50	1.21	287000 64600	245000 55000	1.17		2100000 471000	EE285160	285226
406.400 16.0000	609.524 23.9970	82.550 3.2500	1720000 387000	0.35	1.73	446000 100000	265000 59600	1.68		3420000 769000	EE736160	736238
406.400 16.0000	609.524 23.9970	87.312 3.4375	1720000 387000	0.35	1.73	446000 100000	265000 59600	1.68		3420000 769000	EE736160	736237
406.400 16.0000	609.600 24.0000	92.075 3.6250	1840000 414000	0.38	1.57	477000 107000	313000 70400	1.52		2870000 645000	EE911600	912400
406.400 16.0000	673.100 26.5000	88.900 3.5000	2040000 458000	0.40	1.49	528000 119000	363000 81700	1.45		3370000 758000	EE571602	572650
406.400 16.0000	762.000 30.0000	180.975 7.1250	4180000 941000	0.94	0.64	1080000 244000	1740000 391000	0.62		6840000 1540000	H969249	H969210
409.575 16.1250	546.100 21.5000	87.312 3.4375	1690000 380000	0.42	1.44	438000 98500	313000 70400	1.40		3420000 768000	M667948	M667911
409.575 16.1250	574.675 22.6250	76.200 3.0000	1110000 249000	0.50	1.21	287000 64600	245000 55000	1.17		2100000 471000	EE285162	285226
411.162 16.1875	609.600 24.0000	92.075 3.6250	1840000 414000	0.38	1.57	477000 107000	313000 70400	1.52		2870000 645000	EE911618	912400
415.925 16.3750	590.550 23.2500	114.300 4.5000	2860000 642000	0.33	1.80	740000 166000	421000 94800	1.76		5550000 1250000	M268749	M268710
419.989 16.5350	590.550 23.2500	114.300 4.5000	2860000 642000	0.33	1.80	740000 166000	421000 94800	1.76		5550000 1250000	M268742	M268710
425.450 16.7500	685.698 26.9960	142.875 5.6250	3130000 704000	0.40	1.49	812000 183000	559000 126000	1.45		6030000 1360000	EE328167	328269
425.450 16.7500	700.000 27.5591	150.076 5.9085	3130000 704000	0.40	1.49	812000 183000	559000 126000	1.45		6030000 1360000	NP035656	NP054313
427.038 16.8125	533.400 21.0000	50.800 2.0000	792000 178000	0.33	1.80	205000 46200	117000 26300	1.76		1760000 396000	L269140	L269110
430.212 16.9375	603.250 23.7500	76.200 3.0000	1130000 253000	0.52	1.14	292000 65700	262000 59000	1.11		2190000 491000	EE241693	242375
431.800 17.0000	533.400 21.0000	46.038 1.8125	624000 140000	0.31	1.96	162000 36400	84700 19000	1.91		1520000 342000	80385	80325

⁽¹⁾Based on 1 x 10⁶ revolutions L₁₀ life, for the ISO life-calculation method.

⁽²⁾Consult your Timken engineer for instructions on use or review the Timken Engineering Manual on timken.com/catalogs.

⁽³⁾Based on 90 x 10⁶ revolutions L₁₀ life, for The Timken Company life-calculation method. C₉₀ and C_{a90} are radial and thrust values.

Bearing Dimensions											Geometry Factors			Bearing Weight
Width B	Width C	Eff. Ctr. a ⁽⁴⁾	Shaft			Housing			Cage		G ₁	G ₂	C _g	
			Max Shaft Fillet Radius R ⁽⁵⁾	Backing Shoulder Dia. d _a	Backing Shoulder Dia. d _b	Max Housing Fillet Radius r ⁽⁵⁾	Backing Shoulder Dia. D _a	Backing Shoulder Dia. D _b	A _a ⁽⁶⁾	A _b ⁽⁷⁾				
mm in.	mm in.	mm in.	mm in.	mm in.	mm in.	mm in.	mm in.	mm in.	mm in.	mm in.				kg lbs.
61.120 2.4063	44.450 1.7500	35.6 1.40	6.4 0.25	425.0 16.73	435.0 17.13	6.4 0.25	516.0 20.31	516.0 20.31	13.8 0.54	6.1 0.24	2782.9	448.6	0.2018	40.48 89.24
67.866 2.6719	50.800 2.0000	38.6 1.52	6.8 0.27	431.0 16.97	442.0 17.40	3.3 0.13	535.6 21.09	534.0 21.02	17.7 0.69	3.0 0.12	3036.6	478.1	0.2103	52.88 116.55
79.375 3.1250	60.325 2.3750	13.5 0.53	8.0 0.31	437.0 17.20	449.0 17.68	6.4 0.25	576.1 22.68	570.0 22.44	9.2 0.36	6.4 0.25	4176.8	536.6	0.2096	81.06 178.70
79.375 3.1250	65.088 2.5625	13.5 0.53	8.0 0.31	437.0 17.20	449.0 17.68	6.4 0.25	576.1 22.68	570.0 22.44	9.2 0.36	6.4 0.25	4176.8	536.6	0.2096	83.18 183.38
84.138 3.3125	60.325 2.3750	11.9 0.47	6.8 0.27	439.0 17.28	443.0 17.44	6.4 0.25	570.0 22.44	567.0 22.32	18.4 0.72	6.3 0.25	3251.1	349.1	0.1990	77.77 171.48
87.833 3.4580	60.325 2.3750	20.3 0.80	6.4 0.25	447.0 17.60	453.0 17.83	3.3 0.13	632.6 24.91	630.0 24.80	14.9 0.59	5.5 0.22	3621.0	321.8	0.2093	101.96 224.80
161.925 6.3750	107.950 4.2500	79.2 3.12	12.7 0.50	463.3 18.24	513.0 20.20	12.7 0.50	719.3 28.32	657.0 25.87	25.8 1.01	20.6 0.81	4614.9	207.4	0.2945	331.83 731.56
87.312 3.4375	68.262 2.6875	17.8 0.70	6.4 0.25	431.0 16.97	440.0 17.32	6.4 0.25	526.7 20.74	510.0 20.08	9.4 0.37	3.1 0.13	4197.4	453.5	0.2235	53.65 118.30
67.866 2.6719	50.800 2.0000	38.6 1.52	6.8 0.27	433.0 17.05	444.0 17.48	3.3 0.13	535.6 21.09	534.0 21.02	17.7 0.69	3.0 0.12	3036.6	478.1	0.2103	51.79 114.17
84.138 3.3125	60.325 2.3750	11.9 0.47	6.8 0.27	443.0 17.44	447.0 17.60	6.4 0.25	570.0 22.44	567.0 22.32	18.4 0.72	6.3 0.25	3251.1	349.1	0.1990	77.16 170.14
114.300 4.5000	88.900 3.5000	-9.4 -0.37	6.4 0.25	441.0 17.36	451.0 17.76	6.4 0.25	562.4 22.14	548.9 21.61	10.6 0.41	6.0 0.24	5754.9	420.9	0.2319	99.09 218.45
114.300 4.5000	88.900 3.5000	-9.4 -0.37	1.5 0.06	444.0 17.48	444.0 17.48	6.4 0.25	562.4 22.14	548.9 21.61	10.6 0.41	6.0 0.24	5754.9	420.9	0.2319	97.05 213.94
142.800 5.6220	104.775 4.1250	-8.1 -0.32	12.7 0.50	463.0 18.23	482.0 18.98	6.4 0.25	636.1 25.04	624.0 24.57	21.6 0.85	3.1 0.13	5606.6	353.0	0.2443	190.51 420.03
150.000 5.9055	104.775 4.1250	-15.2 -0.60	12.7 0.50	463.0 18.23	482.0 18.98	6.4 0.25	636.5 25.06	630.0 24.80	31.1 1.22	0.7 0.03	5606.6	353.0	0.2443	209.26 461.36
50.800 2.0000	36.512 1.4375	25.9 1.02	3.3 0.13	442.0 17.40	447.0 17.60	3.3 0.13	522.0 20.55	516.0 20.31	0.0 0.00	0.0 0.00	3088.3	671.4	0.1850	24.17 53.25
73.025 2.8750	50.800 2.0000	47.0 1.85	6.4 0.25	455.0 17.91	465.0 18.31	6.4 0.25	562.8 22.16	558.0 21.97	18.7 0.73	-1.5 -0.05	3353.8	551.6	0.2207	58.84 129.71
46.038 1.8125	34.925 1.3750	23.4 0.92	3.3 0.13	446.0 17.56	450.0 17.72	3.3 0.13	510.0 20.08	510.0 20.08	4.1 0.16	1.2 0.05	3209.2	802.4	0.1815	21.55 47.49

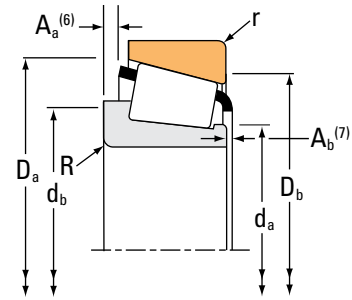
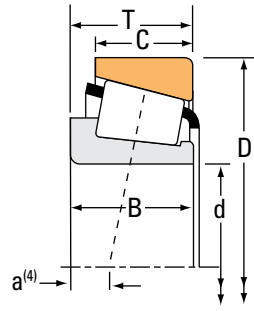
(4) Negative value indicates effective center inside cone (inner-ring) backface.
 (5) These maximum fillet radii will be cleared by the bearing corners.
 (6) Negative value indicates cage extends beyond cone (inner-ring) backface.
 (7) Negative value indicates cage that does not extend beyond cone (inner-ring) front face.

Continued on next page.

TAPERED ROLLER BEARINGS

SINGLE-ROW • TYPE TS

TYPE TS



Bearing Dimensions			Load Ratings							Part Number		
Bore d	O.D. D	Width T	Dynamic ⁽¹⁾		Factors ⁽²⁾		Dynamic ⁽³⁾		Factors ⁽²⁾	Static	Inner	Outer
			C ₁	e	Y	C ₉₀	C _{a90}	K	C ₀			
mm in.	mm in.	mm in.	N lbf			N lbf	N lbf			N lbf		
431.800 17.0000	533.400 21.0000	50.800 2.0000	792000 178000	0.33	1.80	205000 46200	117000 26300	1.76		1760000 396000	L269143	L269110
431.800 17.0000	552.450 21.7500	44.450 1.7500	626000 141000	0.32	1.88	162000 36500	88600 19900	1.83		1550000 348000	80170	80217
431.800 17.0000	565.150 22.2500	44.450 1.7500	626000 141000	0.32	1.88	162000 36500	88600 19900	1.83		1550000 348000	80170	80222
431.800 17.0000	571.500 22.5000	74.612 2.9375	1230000 276000	0.55	1.10	319000 71700	298000 67000	1.07		2810000 632000	LM869448	LM869410
431.800 17.0000	603.250 23.7500	76.200 3.0000	1130000 253000	0.52	1.14	292000 65700	262000 59000	1.11		2190000 491000	EE241701	242375
431.800 17.0000	673.100 26.5000	88.900 3.5000	2040000 458000	0.40	1.49	528000 119000	363000 81700	1.45		3370000 758000	EE571703	572650
431.902 17.0040	685.698 26.9960	177.800 7.0000	4640000 1040000	0.32	1.85	1200000 270000	669000 150000	1.80		9230000 2080000	EE650170	650270
441.325 17.3750	660.400 26.0000	91.280 3.5937	1760000 396000	0.37	1.60	457000 103000	292000 65700	1.56		3630000 816000	EE737173	737260
444.500 17.5000	635.000 25.0000	120.650 4.7500	3280000 736000	0.33	1.80	849000 191000	484000 109000	1.76		6430000 1450000	M270744	M270710
447.675 17.6250	552.450 21.7500	44.450 1.7500	626000 141000	0.32	1.88	162000 36500	88600 19900	1.83		1550000 348000	80176	80217
447.675 17.6250	552.450 21.7500	44.450 1.7500	618000 139000	0.36	1.65	160000 36000	100000 22500	1.60		1510000 340000	LL469949	LL469910
447.675 17.6250	565.150 22.2500	44.450 1.7500	626000 141000	0.32	1.88	162000 36500	88600 19900	1.83		1550000 348000	80176	80222
447.675 17.6250	635.000 25.0000	120.650 4.7500	3280000 736000	0.33	1.80	849000 191000	484000 109000	1.76		6430000 1450000	M270749	M270710
450.850 17.7500	603.250 23.7500	85.725 3.3750	1490000 335000	0.45	1.32	386000 86800	300000 67300	1.29		3440000 773000	LM770945	LM770910
457.073 17.9950	573.088 22.5625	74.612 2.9375	1230000 277000	0.40	1.49	319000 71700	220000 49400	1.45		3170000 713000	L570648	L570610
457.200 18.0000	552.450 21.7500	44.450 1.7500	626000 141000	0.32	1.88	162000 36500	88600 19900	1.83		1550000 348000	80180	80217
457.200 18.0000	573.088 22.5625	74.612 2.9375	1230000 277000	0.40	1.49	319000 71700	220000 49400	1.45		3170000 713000	L570649	L570610

⁽¹⁾Based on 1 x 10⁶ revolutions L₁₀ life, for the ISO life-calculation method.

⁽²⁾Consult your Timken engineer for instructions on use or review the Timken Engineering Manual on timken.com/catalogs.

⁽³⁾Based on 90 x 10⁶ revolutions L₁₀ life, for The Timken Company life-calculation method. C₉₀ and C_{a90} are radial and thrust values.

Bearing Dimensions											Geometry Factors			Bearing Weight
Width B	Width C	Eff. Ctr. a ⁽⁴⁾	Shaft			Housing			Cage		G ₁	G ₂	C _g	
			Max Shaft Fillet Radius R ⁽⁵⁾	Backing Shoulder Dia. d _a	Shoulder Dia. d _b	Max Housing Fillet Radius r ⁽⁵⁾	Backing Shoulder Dia. D _a	Shoulder Dia. D _b	A _a ⁽⁶⁾	A _b ⁽⁷⁾				
mm in.	mm in.	mm in.	mm in.	mm in.	mm in.	mm in.	mm in.	mm in.	mm in.	mm in.				kg lbs.
50.800 2.0000	36.512 1.4375	25.9 1.02	3.3 0.13	445.0 17.52	450.0 17.72	3.3 0.13	522.0 20.55	516.0 20.31	* *	* *	3088.3	671.4	0.1850	22.81 50.26
44.450 1.7500	31.750 1.2500	26.2 1.03	3.3 0.13	452.0 17.80	456.0 17.95	3.3 0.13	531.0 20.91	531.0 20.91	5.8 0.23	4.4 0.18	3437.4	868.7	0.1880	25.07 55.25
44.450 1.7500	31.750 1.2500	26.2 1.03	3.3 0.13	452.0 17.80	456.0 17.95	3.3 0.13	531.0 20.91	537.0 21.14	5.8 0.23	4.4 0.18	3437.4	868.7	0.1880	27.83 61.34
74.612 2.9375	52.388 2.0625	50.0 1.97	3.3 0.13	453.0 17.83	457.0 17.99	3.3 0.13	549.0 21.61	537.0 21.14	11.3 0.44	-0.1 0.00	3719.4	491.5	0.2326	47.68 105.10
73.025 2.8750	50.800 2.0000	47.0 1.85	6.4 0.25	456.9 17.99	446.0 18.35	6.4 0.25	562.8 22.16	558.0 21.97	18.7 0.73	-1.5 -0.05	3353.8	551.6	0.2207	58.22 128.36
87.833 3.4580	60.325 2.3750	20.3 0.80	6.4 0.25	466.0 18.35	472.0 18.58	3.3 0.13	632.6 24.91	630.0 24.80	14.9 0.59	5.7 0.23	3621.0	321.8	0.2093	90.47 199.46
174.625 6.8750	142.875 5.6250	-36.3 -1.43	6.4 0.25	471.0 18.54	477.0 18.78	6.4 0.25	648.5 25.53	627.0 24.69	15.7 0.62	4.1 0.16	7668.4	341.3	0.2542	245.38 540.96
85.725 3.3750	62.705 2.4687	16.8 0.66	10.5 0.41	477.0 18.78	491.0 19.33	6.4 0.25	618.0 24.33	614.9 24.21	14.2 0.56	7.8 0.31	4809.1	573.4	0.2247	99.85 220.12
120.650 4.7500	95.250 3.7500	-8.1 -0.32	6.4 0.25	472.0 18.58	481.0 18.94	6.4 0.25	605.0 23.82	591.0 23.27	9.8 0.38	6.9 0.28	6865.6	481.9	0.2458	123.33 271.89
44.450 1.7500	31.750 1.2500	26.2 1.03	3.3 0.13	464.0 18.27	467.0 18.39	3.3 0.13	531.0 20.91	531.0 20.91	5.8 0.23	4.4 0.18	3437.4	868.7	0.1880	21.26 46.84
41.618 1.6385	32.545 1.2813	35.1 1.38	3.3 0.13	462.0 18.19	466.0 18.35	3.3 0.13	525.0 20.67	528.0 20.79	3.7 0.14	5.0 0.20	3159.1	928.3	0.1912	20.79 45.81
44.450 1.7500	31.750 1.2500	26.2 1.03	3.3 0.13	464.0 18.27	467.0 18.39	3.3 0.13	531.0 20.91	537.0 21.14	5.8 0.23	4.4 0.18	3437.4	868.7	0.1880	24.02 52.94
120.650 4.7500	95.250 3.7500	-8.1 -0.32	6.4 0.25	474.0 18.66	484.0 19.06	6.4 0.25	605.0 23.82	591.0 23.27	9.8 0.38	6.9 0.28	6865.6	481.9	0.2458	121.23 267.26
84.138 3.3125	60.325 2.3750	30.5 1.20	6.4 0.25	474.0 18.66	484.0 19.06	3.3 0.13	579.7 22.82	570.0 22.44	13.4 0.52	3.3 0.13	4660.5	534.5	0.2366	63.95 140.98
74.612 2.9375	57.150 2.2500	27.2 1.07	6.4 0.25	475.0 18.70	485.0 19.09	6.4 0.25	558.0 21.97	543.0 21.38	7.4 0.29	3.7 0.15	4970.4	478.5	0.2321	41.84 92.22
44.450 1.7500	31.750 1.2500	26.2 1.03	3.3 0.13	471.0 18.54	474.0 18.66	3.3 0.13	531.0 20.91	531.0 20.91	5.8 0.23	4.4 0.18	3437.4	868.7	0.1880	18.90 41.63
74.612 2.9375	57.150 2.2500	27.2 1.07	6.4 0.25	475.0 18.70	485.0 19.09	6.4 0.25	558.0 21.97	543.0 21.38	7.4 0.29	3.7 0.15	4970.4	478.5	0.2321	41.77 92.07

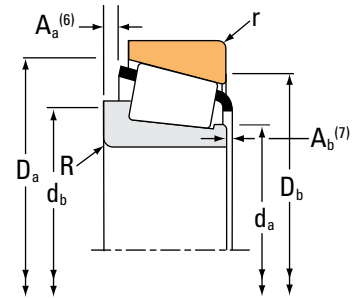
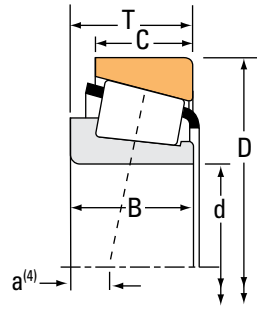
(4) Negative value indicates effective center inside cone (inner-ring) backface.
 (5) These maximum fillet radii will be cleared by the bearing corners.
 (6) Negative value indicates cage extends beyond cone (inner-ring) backface.
 (7) Negative value indicates cage that does not extend beyond cone (inner-ring) front face.
 (*) Contact your Timken engineer for details.

Continued on next page.

TAPERED ROLLER BEARINGS

SINGLE-ROW • TYPE TS

TYPE TS



Bearing Dimensions			Load Ratings							Part Number			
Bore d	O.D. D	Width T	Dynamic ⁽¹⁾		Factors ⁽²⁾		Dynamic ⁽³⁾		Factors ⁽²⁾		Static C ₀	Inner	Outer
			C ₁	e	Y	C ₉₀	C _{a90}	K	N	N			
mm in.	mm in.	mm in.	N lbf			N lbf	N lbf		N lbf		N lbf		
457.200 18.0000	596.900 23.5000	76.200 3.0000	1410000 318000	0.40	1.48	367000 82400	254000 57100	1.44	2890000 649000			EE244180	244235
457.200 18.0000	603.250 23.7500	85.725 3.3750	1490000 335000	0.45	1.32	386000 86800	300000 67300	1.29	3440000 773000			LM770949	LM770910
457.200 18.0000	615.950 24.2500	85.725 3.3750	1940000 436000	0.33	1.80	503000 113000	286000 64400	1.76	4100000 921000			LM272235	LM272210
457.200 18.0000	660.400 26.0000	91.280 3.5937	1760000 396000	0.37	1.60	457000 103000	292000 65700	1.56	3630000 816000			EE737181	737260
457.200 18.0000	660.400 26.0000	92.075 3.6250	1760000 396000	0.37	1.60	457000 103000	292000 65700	1.56	3630000 816000			EE737181X	737262
457.200 18.0000	730.148 28.7460	120.650 4.7500	2830000 635000	0.39	1.53	733000 165000	492000 111000	1.49	4870000 1100000			EE671801	672873
476.250 18.7500	565.150 22.2500	41.275 1.6250	469000 106000	0.47	1.28	122000 27400	97800 22000	1.24	1400000 315000			LL771948	LL771911
479.425 18.8750	679.450 26.7500	128.588 5.0625	3730000 839000	0.33	1.80	968000 218000	551000 124000	1.76	7400000 1660000			M272749	M272710
482.600 19.0000	615.950 24.2500	53.975 2.1250	656000 148000	0.35	1.72	170000 38200	102000 22900	1.67	1710000 384000			80480	80425
482.600 19.0000	615.950 24.2500	85.725 3.3750	1690000 380000	0.33	1.80	439000 98600	250000 56100	1.76	4100000 921000			LM272249	LM272210
482.600 19.0000	634.873 24.9950	80.963 3.1875	1470000 330000	0.34	1.75	380000 85500	223000 50200	1.70	3660000 822000			EE243190	243250
488.671 19.2390	660.400 26.0000	93.662 3.6875	2370000 533000	0.31	1.95	614000 138000	323000 72600	1.90	4590000 1030000			EE640191	640260
488.950 19.2500	634.873 24.9950	84.138 3.3125	1860000 418000	0.47	1.27	482000 108000	390000 87800	1.24	3870000 871000			LM772748	LM772710
488.950 19.2500	660.400 26.0000	93.662 3.6875	2370000 533000	0.31	1.95	614000 138000	323000 72600	1.90	4590000 1030000			EE640192	640260
489.026 19.2530	634.873 24.9950	80.963 3.1875	1470000 330000	0.34	1.75	380000 85500	223000 50200	1.70	3660000 822000			EE243192	243250
498.323 19.6190	634.873 24.9950	80.963 3.1875	1470000 330000	0.34	1.75	380000 85500	223000 50200	1.70	3660000 822000			EE243197	243250
498.475 19.6250	634.873 24.9950	80.963 3.1875	1470000 330000	0.34	1.75	380000 85500	223000 50200	1.70	3660000 822000			EE243196	243250

⁽¹⁾Based on 1 x 10⁶ revolutions L₁₀ life, for the ISO life-calculation method.

⁽²⁾Consult your Timken engineer for instructions on use or review the Timken Engineering Manual on timken.com/catalogs.

⁽³⁾Based on 90 x 10⁶ revolutions L₁₀ life, for The Timken Company life-calculation method. C₉₀ and C_{a90} are radial and thrust values.

Bearing Dimensions											Geometry Factors			Bearing Weight
Width B	Width C	Eff. Ctr. a ⁽⁴⁾	Shaft			Housing			Cage		G ₁	G ₂	C _g	
			Max Shaft Fillet Radius R ⁽⁵⁾	Backing Shoulder Dia. d _a	mm in.	Max Housing Fillet Radius r ⁽⁵⁾	Backing Shoulder Dia. D _a	mm in.	A _a ⁽⁶⁾	A _b ⁽⁷⁾				
mm in.	mm in.	mm in.	mm in.	mm in.	mm in.	mm in.	mm in.	mm in.	mm in.	mm in.			kg lbs.	
73.025 2.8750	53.975 2.1250	26.7 1.05	9.7 0.38	478.0 18.82	494.0 19.45	3.3 0.13	570.0 22.47	567.0 22.32	13.8 0.54	4.0 0.16	4411.8	627.1	0.2233	49.51 109.12
84.138 3.3125	60.325 2.3750	30.5 1.20	6.4 0.25	479.0 18.86	489.0 19.25	3.3 0.13	579.7 22.82	570.0 22.44	13.4 0.52	3.3 0.13	4660.5	534.5	0.2366	59.95 132.16
85.725 3.3750	66.675 2.6250	12.4 0.49	6.4 0.25	483.0 19.02	493.0 19.41	6.4 0.25	597.0 23.48	585.0 23.03	8.0 0.31	4.0 0.16	6037.2	665.8	0.2333	71.13 156.81
85.725 3.3750	62.705 2.4687	16.8 0.66	10.5 0.41	489.0 19.25	503.9 19.84	6.4 0.25	618.0 24.33	614.9 24.21	14.2 0.56	7.8 0.31	4809.1	573.4	0.2247	92.32 203.51
91.262 3.5930	63.500 2.5000	16.8 0.66	6.4 0.25	489.0 19.25	495.0 19.49	6.4 0.25	618.2 24.34	614.9 24.21	14.2 0.56	2.3 0.09	4809.1	573.4	0.2247	95.10 209.66
114.300 4.5000	82.550 3.2500	5.3 0.21	9.7 0.38	491.0 19.33	507.0 19.96	6.4 0.25	681.0 26.79	675.0 26.57	19.8 0.78	10.2 0.41	4968.3	343.4	0.2315	175.01 385.83
41.275 1.6250	31.750 1.2500	58.4 2.30	3.3 0.13	491.0 19.33	495.0 19.49	3.3 0.13	549.0 21.61	543.0 21.38	3.5 0.13	1.4 0.06	3792.4	1237.1	0.2189	18.78 41.40
128.588 5.0625	101.600 4.0000	-8.9 -0.35	6.4 0.25	507.0 19.96	516.0 20.31	6.4 0.25	648.0 25.52	633.0 24.92	9.9 0.39	7.7 0.30	8110.8	508.6	0.2598	149.07 328.63
46.038 1.8125	41.275 1.6250	36.6 1.44	3.3 0.13	501.0 19.72	504.0 19.84	3.3 0.13	579.0 22.80	582.0 22.91	6.2 0.24	3.0 0.12	4148.9	1071.4	0.2056	34.60 76.26
85.725 3.3750	66.675 2.6250	12.4 0.49	6.4 0.25	501.0 19.72	513.0 20.20	6.4 0.25	597.0 23.48	585.0 23.03	8.0 0.31	4.0 0.16	6037.2	665.8	0.2333	58.37 128.68
80.962 3.1875	63.500 2.5000	19.1 0.75	6.4 0.25	510.0 20.08	516.0 20.31	3.3 0.13	609.0 24.00	603.0 23.74	8.1 0.31	2.5 0.10	6057.3	726.6	0.2350	66.20 145.96
94.458 3.7188	69.850 2.7500	4.8 0.19	6.4 0.25	513.0 20.20	522.0 20.55	6.4 0.25	630.5 24.82	624.0 24.57	10.5 0.41	4.6 0.18	6322.4	601.7	0.2310	88.16 194.34
84.138 3.3125	61.912 2.4375	40.9 1.61	6.4 0.25	510.0 20.08	522.0 20.55	3.3 0.13	613.3 24.15	600.0 23.62	10.2 0.40	3.0 0.12	5447.5	602.2	0.2525	64.23 141.61
94.458 3.7188	69.850 2.7500	4.8 0.19	6.4 0.25	513.0 20.20	522.0 20.55	6.4 0.25	630.5 24.82	624.0 24.57	10.5 0.41	4.6 0.18	6322.4	601.7	0.2310	88.01 193.99
80.962 3.1875	63.500 2.5000	19.1 0.75	6.4 0.25	516.0 20.31	522.0 20.55	3.3 0.13	609.0 24.00	603.0 23.74	8.1 0.31	2.5 0.10	6057.3	726.6	0.2350	62.88 138.62
80.962 3.1875	63.500 2.5000	19.1 0.75	6.4 0.25	522.0 20.55	528.0 20.79	3.3 0.13	609.0 24.00	603.0 23.74	8.1 0.31	2.5 0.10	6057.3	726.6	0.2350	58.31 128.55
80.962 3.1875	63.500 2.5000	19.1 0.75	6.4 0.25	522.0 20.55	528.0 20.79	3.3 0.13	609.0 24.00	603.0 23.74	8.1 0.31	2.5 0.10	6057.3	726.6	0.2350	58.44 128.85

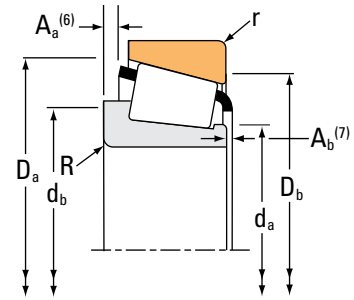
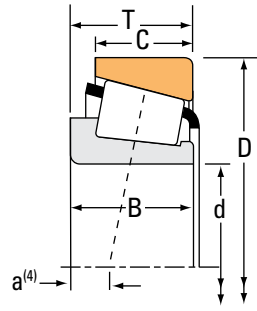
(4) Negative value indicates effective center inside cone (inner-ring) backface.
 (5) These maximum fillet radii will be cleared by the bearing corners.
 (6) Negative value indicates cage extends beyond cone (inner-ring) backface.
 (7) Negative value indicates cage that does not extend beyond cone (inner-ring) front face.

Continued on next page.

TAPERED ROLLER BEARINGS

SINGLE-ROW • TYPE TS

TYPE TS



Bearing Dimensions			Load Ratings							Part Number		
Bore d	O.D. D	Width T	Dynamic ⁽¹⁾		Factors ⁽²⁾		Dynamic ⁽³⁾		Factors ⁽²⁾	Static	Inner	Outer
			C ₁	e	Y	C ₉₀	C _{a90}	K	C ₀			
mm in.	mm in.	mm in.	N lbf			N lbf	N lbf		N lbf			
500.000 19.6850	640.000 25.1969	80.000 3.1496	1710000 384000	0.35	1.73	443000 99500	262000 59000	1.69	3750000 844000		NP267201	NP876612
501.650 19.7500	596.900 23.5000	53.975 2.1250	695000 156000	0.35	1.72	180000 40500	108000 24200	1.67	1710000 384000		80487	80418
501.650 19.7500	711.200 28.0000	136.525 5.3750	3530000 794000	0.33	1.80	916000 206000	521000 117000	1.76	8070000 1820000		M274149	M274110
508.000 20.0000	736.600 29.0000	88.900 3.5000	1990000 447000	0.47	1.27	516000 116000	418000 94000	1.23	3430000 772000		EE982003	982900
508.000 20.0000	838.200 33.0000	146.050 5.7500	3610000 812000	0.48	1.25	936000 210000	769000 173000	1.22	6530000 1470000		EE426200	426330
514.350 20.2500	736.600 29.0000	88.900 3.5000	1990000 447000	0.47	1.27	516000 116000	418000 94000	1.23	3430000 772000		EE982028	982900
520.700 20.5000	736.600 29.0000	88.900 3.5000	1990000 447000	0.47	1.27	516000 116000	418000 94000	1.23	3430000 772000		EE982051	982900
533.400 21.0000	635.000 25.0000	50.800 2.0000	892000 201000	0.41	1.48	231000 52000	161000 36100	1.44	2040000 459000		LL575343	LL575310
533.400 21.0000	784.225 30.8750	88.900 3.5000	2170000 487000	0.48	1.26	561000 126000	457000 103000	1.23	3880000 873000		EE522102	523087
536.575 21.1250	761.873 29.9950	146.050 5.7500	4010000 902000	0.33	1.80	1040000 234000	592000 133000	1.76	9250000 2080000		M276449	M276410
536.575 21.1250	780.000 30.7087	150.000 5.9055	4010000 902000	0.33	1.80	1040000 234000	592000 133000	1.76	9250000 2080000		NP266377	NP543910
539.750 21.2500	635.000 25.0000	50.800 2.0000	892000 201000	0.41	1.48	231000 52000	161000 36100	1.44	2040000 459000		LL575349	LL575310
546.100 21.5000	736.600 29.0000	76.200 3.0000	1400000 315000	0.51	1.18	363000 81600	316000 71000	1.15	3240000 728000		EE542215	542290
549.097 21.6180	692.150 27.2500	80.962 3.1875	1520000 342000	0.38	1.59	394000 88500	254000 57000	1.55	3970000 892000		L476548	L476510
549.275 21.6250	692.150 27.2500	80.962 3.1875	1520000 342000	0.38	1.59	394000 88500	254000 57000	1.55	3970000 892000		L476549	L476510
558.800 22.0000	723.900 28.5000	73.025 2.8750	1540000 345000	0.49	1.21	398000 89500	337000 75700	1.18	3440000 773000		EE647220	647285
558.800 22.0000	736.600 29.0000	76.200 3.0000	1400000 315000	0.51	1.18	363000 81600	316000 71000	1.15	3240000 728000		EE542220	542290

⁽¹⁾Based on 1 x 10⁶ revolutions L₁₀ life, for the ISO life-calculation method.

⁽²⁾Consult your Timken engineer for instructions on use or review the Timken Engineering Manual on timken.com/catalogs.

⁽³⁾Based on 90 x 10⁶ revolutions L₁₀ life, for The Timken Company life-calculation method. C₉₀ and C_{a90} are radial and thrust values.

Bearing Dimensions											Geometry Factors			Bearing Weight
Width B	Width C	Eff. Ctr. a ⁽⁴⁾	Shaft			Housing			Cage		G ₁	G ₂	C _g	
			Max Shaft Fillet Radius R ⁽⁵⁾	Backing Shoulder Dia. d _a	Backing Shoulder Dia. d _b	Max Housing Fillet Radius r ⁽⁵⁾	Backing Shoulder Dia. D _a	Backing Shoulder Dia. D _b	A _a ⁽⁶⁾	A _b ⁽⁷⁾				
mm in.	mm in.	mm in.	mm in.	mm in.	mm in.	mm in.	mm in.	mm in.	mm in.	mm in.				kg lbs.
80.000 3.1496	63.500 2.5000	21.3 0.84	6.4 0.25	522.0 20.55	534.0 21.02	3.3 0.13	616.0 24.25	611.9 24.09	7.2 0.28	2.7 0.11	6257.5	879.0	0.2384	61.55 135.68
46.038 1.8125	41.275 1.6250	36.6 1.44	3.3 0.13	516.0 20.31	519.0 20.43	3.3 0.13	579.0 22.80	576.0 22.68	6.2 0.24	3.0 0.12	4148.9	1071.4	0.2056	23.50 51.79
136.525 5.3750	106.362 4.1875	-10.7 -0.42	6.4 0.25	534.0 21.02	540.0 21.26	6.4 0.25	677.9 26.69	663.0 26.10	12.2 0.48	8.6 0.34	9019.6	560.7	0.2690	170.67 376.26
81.758 3.2188	53.975 2.1250	45.5 1.79	6.4 0.25	543.0 21.38	549.0 21.61	3.3 0.13	693.0 27.28	693.0 27.28	18.5 0.72	7.7 0.31	4901.2	606.3	0.2429	107.55 237.10
139.700 5.5000	104.775 4.1250	23.9 0.94	9.7 0.38	552.0 21.73	564.0 22.20	9.7 0.38	767.7 30.23	759.0 29.88	21.5 0.84	8.3 0.33	6651.9	435.2	0.2722	290.75 640.99
81.758 3.2188	53.975 2.1250	45.5 1.79	6.4 0.25	549.0 21.61	555.0 21.85	3.3 0.13	693.0 27.28	693.0 27.28	18.5 0.72	7.7 0.31	4901.2	606.3	0.2429	104.29 229.91
81.758 3.2188	53.975 2.1250	45.5 1.79	6.4 0.25	552.0 21.73	558.0 21.97	3.3 0.13	693.0 27.28	693.0 27.28	18.5 0.72	7.7 0.31	4901.2	606.3	0.2429	100.98 222.62
50.800 2.0000	38.100 1.5000	50.8 2.00	6.4 0.25	549.0 21.61	558.0 21.97	6.4 0.25	621.0 24.45	612.0 24.09	4.5 0.18	2.8 0.11	4808.4	1201.1	0.2270	27.24 60.05
82.550 3.2500	53.975 2.1250	52.6 2.07	6.4 0.25	570.0 22.44	576.0 22.68	6.4 0.25	735.0 28.94	732.0 28.82	12.5 0.49	8.5 0.34	5013.3	457.2	0.2452	125.58 276.85
146.050 5.7500	114.300 4.5000	-9.7 -0.38	6.4 0.25	570.0 22.44	576.0 22.68	6.4 0.25	725.6 28.57	711.0 27.99	13.3 0.52	5.5 0.22	10625.0	614.5	0.2839	211.00 465.18
150.000 5.9055	114.300 4.5000	-13.7 -0.54	6.4 0.25	570.0 22.44	576.0 22.68	6.4 0.25	726.0 28.58	720.0 28.35	18.4 0.72	4.5 0.18	10625.0	614.5	0.2839	234.26 516.46
50.800 2.0000	38.100 1.5000	50.8 2.00	6.4 0.25	555.0 21.85	564.0 22.20	6.4 0.25	621.0 24.45	612.0 24.09	4.5 0.18	2.8 0.11	4808.4	1201.1	0.2270	25.10 55.34
76.200 3.0000	50.800 2.0000	64.8 2.55	6.4 0.25	576.0 22.68	585.0 23.03	6.4 0.25	705.1 27.76	696.0 27.40	16.6 0.65	1.6 0.07	5727.7	782.5	0.2604	84.23 185.69
80.962 3.1875	61.912 2.4375	32.3 1.27	6.4 0.25	570.0 22.44	579.0 22.80	6.4 0.25	666.0 26.22	657.0 25.87	8.5 0.33	2.6 0.11	7261.6	889.8	0.2567	67.13 148.00
80.962 3.1875	61.912 2.4375	32.3 1.27	6.4 0.25	570.0 22.44	579.0 22.80	6.4 0.25	666.0 26.22	657.0 25.87	8.5 0.33	2.6 0.11	7261.6	889.8	0.2567	66.85 147.39
73.025 2.8750	57.150 2.2500	64.5 2.54	4.8 0.19	582.0 22.91	588.0 23.15	4.8 0.19	701.1 27.60	687.0 27.05	8.5 0.33	3.5 0.14	5594.2	804.2	0.2566	73.36 161.74
76.200 3.0000	50.800 2.0000	64.8 2.55	6.4 0.25	585.0 23.03	594.0 23.39	6.4 0.25	705.1 27.76	696.0 27.40	16.6 0.65	1.6 0.07	5727.7	782.5	0.2604	77.61 171.10

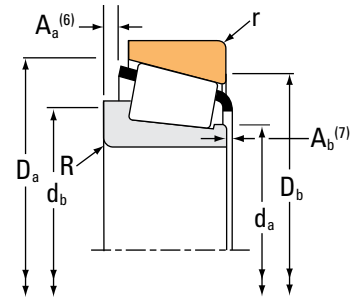
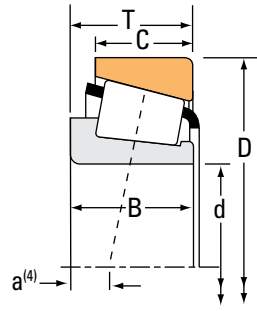
(4) Negative value indicates effective center inside cone (inner-ring) backface.
 (5) These maximum fillet radii will be cleared by the bearing corners.
 (6) Negative value indicates cage extends beyond cone (inner-ring) backface.
 (7) Negative value indicates cage that does not extend beyond cone (inner-ring) front face.

Continued on next page.

TAPERED ROLLER BEARINGS

SINGLE-ROW • TYPE TS

TYPE TS



Bearing Dimensions			Load Ratings							Part Number		
Bore d	O.D. D	Width T	Dynamic ⁽¹⁾		Factors ⁽²⁾		Dynamic ⁽³⁾		Factors ⁽²⁾	Static	Inner	Outer
			C ₁	e	Y	C ₉₀	C _{a90}	K	C ₀			
mm in.	mm in.	mm in.	N lbf			N lbf	N lbf			N lbf		
558.800 22.0000	736.600 29.0000	88.108 3.4688	2070000 465000	0.34	1.75	536000 121000	315000 70700	1.70	4580000 1030000	EE843220	843290	
558.800 22.0000	736.600 29.0000	104.775 4.1250	2570000 578000	0.35	1.73	667000 150000	395000 88800	1.69	6370000 1430000	LM377449	LM377410	
558.800 22.0000	901.573 35.4950	134.938 5.3125	3790000 853000	0.41	1.47	984000 221000	687000 154000	1.43	6760000 1520000	EE327220	327355	
571.500 22.5000	812.800 32.0000	155.575 6.1250	4530000 1020000	0.33	1.80	1180000 264000	669000 150000	1.76	10600000 2370000	M278749	M278710	
571.500 22.5000	812.800 32.0000	160.350 6.3130	4530000 1020000	0.33	1.80	1180000 264000	669000 150000	1.76	10600000 2370000	NP794398	NP384818	
584.200 23.0000	685.800 27.0000	49.212 1.9375	798000 179000	0.44	1.37	207000 46500	155000 34800	1.34	2280000 513000	LL778149	LL778110	
584.200 23.0000	709.612 27.9375	58.738 2.3125	1210000 271000	0.48	1.26	313000 70300	254000 57200	1.23	2930000 659000	L778149	L778110	
584.200 23.0000	901.700 35.5000	150.020 5.9063	4980000 1120000	0.33	1.81	1290000 290000	732000 165000	1.76	7590000 1710000	EE662303	663550	
596.900 23.5000	685.800 27.0000	31.750 1.2500	344000 77300	0.53	1.14	89200 20000	80400 18100	1.11	963000 217000	680235	680270	
602.945 23.7380	787.400 31.0000	93.662 3.6875	2610000 587000	0.37	1.62	677000 152000	430000 96600	1.58	5620000 1260000	EE649237	649310	
607.720 23.9260	787.400 31.0000	93.662 3.6875	2610000 587000	0.37	1.62	677000 152000	430000 96600	1.58	5620000 1260000	EE649239	649310	
609.346 23.9900	787.400 31.0000	93.662 3.6875	2610000 587000	0.37	1.62	677000 152000	430000 96600	1.58	5620000 1260000	EE649238	649310	
609.397 23.9920	762.000 30.0000	95.250 3.7500	1980000 445000	0.49	1.23	513000 115000	428000 96300	1.20	5470000 1230000	L879946	L879910	
609.600 24.0000	762.000 30.0000	95.250 3.7500	1980000 445000	0.49	1.23	513000 115000	428000 96300	1.20	5470000 1230000	L879947	L879910	
609.600 24.0000	774.700 30.5000	85.725 3.3750	2020000 453000	0.40	1.49	523000 118000	360000 80900	1.45	4620000 1040000	L580049	L580010	
609.600 24.0000	787.400 31.0000	93.662 3.6875	2610000 587000	0.37	1.62	677000 152000	430000 96600	1.58	5620000 1260000	EE649240	649310	
609.600 24.0000	787.400 31.0000	93.662 3.6875	2540000 570000	0.37	1.62	657000 148000	417000 93800	1.58	5390000 1210000	EE649240H	649310	

⁽¹⁾Based on 1 x 10⁶ revolutions L₁₀ life, for the ISO life-calculation method.

⁽²⁾Consult your Timken engineer for instructions on use or review the Timken Engineering Manual on timken.com/catalogs.

⁽³⁾Based on 90 x 10⁶ revolutions L₁₀ life, for The Timken Company life-calculation method. C₉₀ and C_{a90} are radial and thrust values.

Bearing Dimensions											Geometry Factors			Bearing Weight
Width B	Width C	Eff. Ctr. a ⁽⁴⁾	Shaft			Housing			Cage		G ₁	G ₂	C _g	
			Max Shaft Fillet Radius R ⁽⁵⁾	Backing Shoulder Dia. d _a	mm in.	Max Housing Fillet Radius r ⁽⁵⁾	Backing Shoulder Dia. D _a	mm in.	A _a ⁽⁶⁾	A _b ⁽⁷⁾				
mm in.	mm in.	mm in.	mm in.	mm in.	mm in.	mm in.	mm in.	mm in.	mm in.	mm in.			kg lbs.	
88.108 3.4688	63.500 2.5000	22.6 0.89	6.4 0.25	585.0 23.03	591.0 23.27	6.4 0.25	707.1 27.84	699.0 27.52	10.6 0.42	4.1 0.16	7097.5	714.8	0.2478	94.77 208.94
104.775 4.1250	80.962 3.1875	15.7 0.62	6.4 0.25	585.0 23.03	594.0 23.39	6.4 0.25	708.0 27.87	696.0 27.40	8.9 0.35	5.6 0.22	9314.8	907.6	0.2735	118.57 261.39
129.380 5.0937	101.600 4.0000	16.8 0.66	12.7 0.50	606.0 23.86	624.0 24.57	6.4 0.25	840.0 33.07	831.0 32.72	29.4 1.16	6.1 0.24	7790.8	478.4	0.2715	311.89 687.90
155.575 6.1250	120.650 4.7500	-11.4 -0.45	6.4 0.25	609.0 23.98	615.0 24.21	6.4 0.25	774.0 30.46	756.0 29.76	15.0 0.59	5.9 0.23	12425.1	669.4	0.2990	255.86 564.08
160.325 6.3120	125.425 4.9380	-12.7 -0.50	8.0 0.31	609.0 23.98	618.0 24.33	6.4 0.25	774.5 30.49	759.0 29.88	16.4 0.64	2.5 0.10	12425.1	669.4	0.2990	262.48 578.69
49.212 1.9375	34.925 1.3750	64.5 2.54	3.5 0.14	600.0 23.62	603.0 23.74	3.3 0.13	669.0 26.34	663.0 26.10	5.0 0.20	2.6 0.11	5980.0	1581.3	0.2494	29.06 64.06
57.150 2.2500	39.688 1.5625	68.8 2.71	3.5 0.14	603.0 23.74	606.0 23.86	3.3 0.13	690.6 27.19	684.0 26.93	5.7 0.22	6.2 0.25	5712.9	1057.7	0.2541	43.61 96.14
139.700 5.5000	107.950 4.2500	0.3 0.01	8.0 0.31	624.0 24.57	633.0 24.92	9.7 0.38	848.1 33.39	843.0 33.19	20.7 0.81	7.2 0.29	8756.7	477.1	0.2638	305.28 673.03
31.750 1.2500	25.400 1.0000	96.0 3.78	3.5 0.14	615.0 24.21	615.0 24.21	3.3 0.13	669.0 26.34	663.0 26.10	1.6 0.06	-0.3 -0.01	3739.1	1810.4	0.2225	16.50 36.38
93.662 3.6875	69.850 2.7500	31.5 1.24	6.4 0.25	630.0 24.80	639.0 25.16	6.4 0.25	755.3 29.74	747.0 29.41	11.1 0.43	6.2 0.25	9384.8	930.0	0.2790	116.23 256.19
93.662 3.6875	69.850 2.7500	31.5 1.24	6.4 0.25	633.0 24.92	642.0 25.28	6.4 0.25	755.3 29.74	747.0 29.41	11.1 0.43	6.2 0.25	9384.8	930.0	0.2790	112.90 248.85
93.662 3.6875	69.850 2.7500	31.5 1.24	6.4 0.25	633.0 24.92	642.0 25.28	6.4 0.25	755.3 29.74	747.0 29.41	11.1 0.43	6.2 0.25	9384.8	930.0	0.2790	111.76 246.34
92.075 3.6250	71.438 2.8125	57.9 2.28	6.4 0.25	633.0 24.92	642.0 25.28	6.4 0.25	741.0 29.17	720.0 28.35	11.7 0.46	5.1 0.20	9578.8	1006.3	0.3063	93.40 205.91
92.075 3.6250	71.438 2.8125	57.9 2.28	6.4 0.25	633.0 24.92	642.0 25.28	6.4 0.25	741.0 29.17	720.0 28.35	11.7 0.46	5.1 0.20	9578.8	1006.3	0.3063	93.26 205.60
79.375 3.1250	60.325 2.3750	45.2 1.78	6.4 0.25	633.0 24.92	642.0 25.28	6.4 0.25	749.5 29.51	741.0 29.17	-8.9 -0.35	3.9 0.15	7661.4	933.9	0.2671	86.98 191.74
93.662 3.6875	69.850 2.7500	31.5 1.24	6.4 0.25	633.0 24.92	642.0 25.28	6.4 0.25	755.3 29.74	747.0 29.41	11.1 0.43	6.2 0.25	9384.8	930.0	0.2790	111.58 245.95
93.662 3.6875	69.850 2.7500	31.5 1.24	6.4 0.25	633.0 24.92	642.0 25.28	6.4 0.25	755.3 29.74	747.0 29.41	13.7 0.54	5.1 0.20	9115.2	904.3	0.2761	106.87 235.60

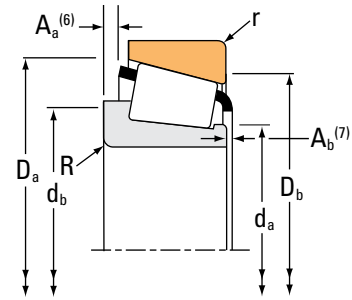
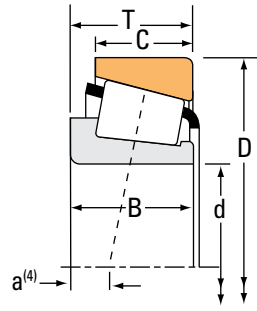
⁽⁴⁾Negative value indicates effective center inside cone (inner-ring) backface.
⁽⁵⁾These maximum fillet radii will be cleared by the bearing corners.
⁽⁶⁾Negative value indicates cage extends beyond cone (inner-ring) backface.
⁽⁷⁾Negative value indicates cage that does not extend beyond cone (inner-ring) front face.

Continued on next page.

TAPERED ROLLER BEARINGS

SINGLE-ROW • TYPE TS

TYPE TS



Bearing Dimensions			Load Ratings							Part Number			
Bore d	O.D. D	Width T	Dynamic ⁽¹⁾		Factors ⁽²⁾		Dynamic ⁽³⁾		Factors ⁽²⁾		Static C ₀	Inner	Outer
			C ₁	e	Y	C ₉₀	C _{a90}	K	N	N			
mm in.	mm in.	mm in.	N lbf			N lbf	N lbf		N lbf		N lbf		
609.600 24.0000	812.800 32.0000	82.550 3.2500	2080000 467000	0.33	1.82	538000 121000	303000 68200	1.77	4060000 912000			EE743240	743320
615.950 24.2500	708.025 27.8750	41.275 1.6250	605000 136000	0.39	1.55	157000 35200	104000 23400	1.51	1840000 414000			LL580049	LL580010
630.000 24.8031	850.000 33.4646	108.000 4.2520	2890000 649000	0.40	1.51	748000 168000	510000 115000	1.47	5910000 1330000			JL580946	JL580914
635.000 25.0000	736.600 29.0000	57.150 2.2500	654000 147000	0.44	1.37	169000 38100	127000 28600	1.33	1830000 412000			80780	80720
635.000 25.0000	933.450 36.7500	179.388 7.0625	5860000 1320000	0.33	1.80	1520000 342000	865000 195000	1.76	13900000 3120000			M281635	M281610
646.112 25.4375	857.250 33.7500	141.288 5.5625	4700000 1060000	0.33	1.80	1220000 274000	694000 156000	1.76	10400000 2330000			LM281049	LM281010
660.235 25.9935	812.800 32.0000	95.250 3.7500	2530000 570000	0.33	1.80	657000 148000	374000 84100	1.76	5940000 1340000			L281146	L281110
660.400 26.0000	812.800 32.0000	92.250 3.7500	2530000 570000	0.33	1.80	657000 148000	374000 84100	1.76	5940000 1340000			L281148	L281110
660.400 26.0000	812.800 32.0000	95.250 3.7500	2730000 615000	0.33	1.80	709000 159000	404000 90700	1.76	6620000 1490000			L281147	L281110
660.400 26.0000	854.075 33.6250	85.725 3.3750	2240000 504000	0.35	1.71	581000 131000	349000 78600	1.66	4620000 1040000			EE749260	749336
660.400 26.0000	854.923 33.6584	85.113 3.3509	2240000 504000	0.35	1.71	581000 131000	349000 78600	1.66	4620000 1040000			EE749260	749334
660.400 26.0000	939.800 37.0000	136.525 5.3750	3560000 800000	0.41	1.48	923000 207000	642000 144000	1.44	7800000 1750000			EE538261	538370
660.400 26.0000	939.800 37.0000	136.525 5.3750	3560000 800000	0.41	1.48	923000 207000	642000 144000	1.44	7800000 1750000			EE538260	538370
673.100 26.5000	793.750 31.2500	66.675 2.6250	1110000 249000	0.36	1.67	287000 64600	177000 39800	1.62	3140000 707000			LL481448	LL481411
673.100 26.5000	922.731 36.3280	133.350 5.2500	5540000 1250000	0.28	2.12	1440000 323000	695000 156000	2.07	10700000 2410000			NP813945	NP216163
679.450 26.7500	901.700 35.5000	142.875 5.6250	5020000 1130000	0.33	1.80	1300000 292000	741000 166000	1.76	11000000 2480000			LM281849	LM281810
682.625 26.8750	965.200 38.0000	185.737 7.3125	6240000 1400000	0.33	1.80	1620000 364000	921000 207000	1.76	14900000 3340000			M282249	M282210

⁽¹⁾Based on 1 x 10⁶ revolutions L₁₀ life, for the ISO life-calculation method.

⁽²⁾Consult your Timken engineer for instructions on use or review the Timken Engineering Manual on timken.com/catalogs.

⁽³⁾Based on 90 x 10⁶ revolutions L₁₀ life, for The Timken Company life-calculation method. C₉₀ and C_{a90} are radial and thrust values.

Bearing Dimensions											Geometry Factors			Bearing Weight
Width B	Width C	Eff. Ctr. a ⁽⁴⁾	Shaft			Housing			Cage		G ₁	G ₂	C _g	
			Max Shaft Fillet Radius R ⁽⁵⁾	Backing Shoulder Dia. d _a	Backing Shoulder Dia. d _b	Max Housing Fillet Radius r ⁽⁵⁾	Backing Shoulder Dia. D _a	Backing Shoulder Dia. D _b	A _a ⁽⁶⁾	A _b ⁽⁷⁾				
mm in.	mm in.	mm in.	mm in.	mm in.	mm in.	mm in.	mm in.	mm in.	mm in.	mm in.				kg lbs.
82.550 3.2500	60.325 2.3750	29.7 1.17	6.4 0.25	636.0 25.04	645.0 25.39	6.4 0.25	768.0 30.24	768.0 30.24	10.8 0.42	4.4 0.18	7714.7	995.4	0.2499	109.52 241.45
41.275 1.6250	29.367 1.1562	61.7 2.43	3.5 0.14	630.0 24.80	633.0 24.92	3.3 0.13	690.0 27.17	687.0 27.05	3.1 0.12	2.8 0.11	6265.9	2025.9	0.2418	23.09 50.92
100.000 3.9370	78.000 3.0709	35.6 1.40	7.5 0.30	660.0 25.98	672.0 26.46	6.0 0.24	804.0 31.65	801.0 31.54	16.1 0.63	11.7 0.46	9816.1	894.2	0.2896	158.02 348.38
53.975 2.1250	41.275 1.6250	69.3 2.73	3.3 0.13	651.0 25.63	654.0 25.75	3.3 0.13	717.8 28.26	714.0 28.11	9.2 0.36	0.2 0.01	5883.6	1625.0	0.2465	33.83 74.57
177.800 7.0000	141.288 5.5625	-13.5 -0.53	12.0 0.47	687.0 27.05	699.0 27.52	6.4 0.25	889.5 35.02	870.0 34.25	17.9 0.70	9.7 0.38	17304.9	775.6	0.3335	418.43 922.49
141.288 5.5625	109.538 4.3125	3.0 0.12	6.4 0.25	678.0 26.69	684.0 26.93	6.4 0.25	824.5 32.46	810.0 31.89	13.3 0.52	7.5 0.30	14763.0	920.6	0.3153	219.31 483.50
95.250 3.7500	73.025 2.8750	27.9 1.10	6.4 0.25	681.0 26.81	693.0 27.28	6.4 0.25	789.0 31.04	777.0 30.59	8.9 0.35	4.5 0.18	11705.7	915.8	0.2888	99.84 220.13
95.250 3.7500	73.025 2.8750	27.9 1.10	6.4 0.25	681.0 26.81	693.0 27.28	6.4 0.25	789.0 31.04	777.0 30.59	8.9 0.35	5.3 0.21	11705.7	915.8	0.2888	99.94 220.33
95.250 3.7500	73.025 2.8750	27.9 1.10	6.4 0.25	681.0 26.81	693.0 27.28	6.4 0.25	789.0 31.04	777.0 30.59	8.7 0.34	5.1 0.20	12635.6	984.9	0.2968	103.68 228.59
85.468 3.3649	60.325 2.3750	39.4 1.55	9.7 0.38	687.0 27.05	702.0 27.64	6.4 0.25	813.0 32.01	813.0 32.01	11.6 0.45	2.4 0.10	9222.1	1151.5	0.2707	114.24 251.84
85.468 3.3649	59.898 2.3582	39.4 1.55	9.7 0.38	687.0 27.05	702.0 27.64	9.7 0.38	813.0 32.01	807.0 31.77	11.6 0.45	2.4 0.10	9222.1	1151.5	0.2707	113.89 251.05
127.000 5.0000	98.425 3.8750	30.7 1.21	6.4 0.25	696.0 27.40	708.0 27.87	6.4 0.25	883.9 34.80	876.0 34.49	22.0 0.86	8.3 0.33	11455.4	802.1	0.3078	275.36 607.05
127.000 5.0000	98.425 3.8750	30.7 1.21	6.4 0.25	696.0 27.40	708.0 27.87	6.4 0.25	883.9 34.80	876.0 34.49	22.0 0.86	8.3 0.33	11455.4	802.1	0.3078	275.36 607.05
61.912 2.4375	49.212 1.9375	53.8 2.12	6.4 0.25	690.0 27.17	702.0 27.64	6.4 0.25	771.0 30.35	765.0 30.12	4.0 0.16	1.6 0.07	8762.7	1649.9	0.2659	51.80 114.21
135.103 5.3190	110.061 4.3331	3.6 0.14	25.4 1.00	711.0 27.99	756.0 29.76	6.4 0.25	891.0 35.08	876.0 34.49	3.1 0.12	8.2 0.33	15064.3	922.1	0.3002	267.37 589.46
142.875 5.6250	111.125 4.3750	6.9 0.27	9.7 0.38	714.0 28.11	726.0 28.58	6.4 0.25	866.6 34.12	852.0 33.54	12.8 0.50	7.4 0.30	16257.4	961.7	0.3252	246.25 542.86
185.738 7.3125	142.875 5.6250	-15.2 -0.60	9.7 0.38	723.0 28.46	738.0 29.06	6.4 0.25	919.8 36.21	900.0 35.43	19.2 0.75	10.5 0.42	18773.0	843.1	0.3426	426.04 939.28

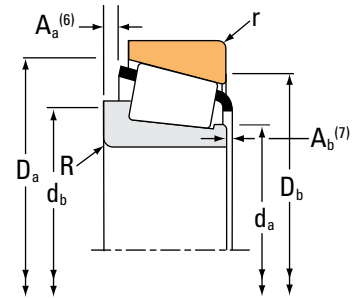
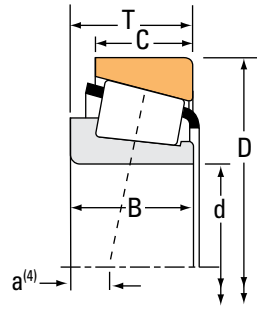
⁽⁴⁾Negative value indicates effective center inside cone (inner-ring) backface.
⁽⁵⁾These maximum fillet radii will be cleared by the bearing corners.
⁽⁶⁾Negative value indicates cage extends beyond cone (inner-ring) backface.
⁽⁷⁾Negative value indicates cage that does not extend beyond cone (inner-ring) front face.

Continued on next page.

TAPERED ROLLER BEARINGS

SINGLE-ROW • TYPE TS

TYPE TS



Bearing Dimensions			Load Ratings							Part Number		
Bore d	O.D. D	Width T	Dynamic ⁽¹⁾		Factors ⁽²⁾		Dynamic ⁽³⁾		Factors ⁽²⁾	Static	Inner	Outer
			C ₁	e	Y	C ₉₀	C _{a90}	K	C ₀			
mm in.	mm in.	mm in.	N lbf			N lbf	N lbf			N lbf		
685.800 27.0000	876.300 34.5000	93.662 3.6875	2750000 619000	0.42	1.44	714000 160000	508000 114000	1.40		630000 1420000	EE655270	655345
698.500 27.5000	819.150 32.2500	63.500 2.5000	1050000 237000	0.35	1.72	273000 61500	164000 36800	1.67		3190000 716000	LL382149	LL382110
711.200 28.0000	914.400 36.0000	85.725 3.3750	2390000 536000	0.38	1.58	619000 139000	403000 90600	1.54		5190000 1170000	EE755280	755360
723.900 28.5000	914.400 36.0000	84.138 3.3125	2390000 536000	0.38	1.58	619000 139000	403000 90600	1.54		5190000 1170000	EE755285	755360
736.600 29.0000	825.500 32.5000	31.750 1.2500	424000 95300	0.40	1.51	110000 24700	74800 16800	1.47		1300000 291000	LL582949	LL582910
749.300 29.5000	965.200 38.0000	93.662 3.6875	2450000 552000	0.40	1.49	636000 143000	438000 98400	1.45		5510000 1240000	EE752295	752380
749.300 29.5000	990.600 39.0000	159.500 6.2795	5980000 1340000	0.33	1.80	1550000 349000	883000 198000	1.76		13500000 3050000	LM283649	LM283610
749.300 29.5000	990.600 39.0000	159.500 6.2795	5130000 1150000	0.33	1.80	1330000 299000	757000 170000	1.76		13200000 2980000	LM283649H	LM283610
759.925 29.9183	889.000 35.0000	69.850 2.7500	1570000 352000	0.38	1.58	406000 91400	263000 59200	1.54		4270000 960000	LL483448	LL483418
759.925 29.9183	889.000 35.0000	88.900 3.5000	2350000 529000	0.31	1.97	610000 137000	319000 71700	1.91		6230000 1400000	L183448	L183410
762.000 30.0000	889.000 35.0000	63.500 2.5000	1080000 243000	0.38	1.58	280000 62900	182000 40800	1.54		3390000 762000	EE175301	175350
762.000 30.0000	889.000 35.0000	69.850 2.7500	1080000 243000	0.38	1.58	280000 62900	182000 40800	1.54		3390000 762000	EE175300	175350
762.000 30.0000	889.000 35.0000	69.850 2.7500	1570000 352000	0.38	1.58	406000 91400	263000 59200	1.54		4270000 960000	LL483449	LL483418
762.000 30.0000	889.000 35.0000	88.900 3.5000	2350000 529000	0.31	1.97	610000 137000	319000 71700	1.91		6230000 1400000	L183449	L183410
762.000 30.0000	965.200 38.0000	93.662 3.6875	2450000 552000	0.40	1.49	636000 143000	438000 98400	1.45		5510000 1240000	EE752300	752380
774.700 30.5000	965.200 38.0000	93.662 3.6875	2450000 552000	0.40	1.49	636000 143000	438000 98400	1.45		5510000 1240000	EE752305	752380
801.688 31.5625	914.400 36.0000	58.738 2.3125	1090000 244000	0.40	1.51	281000 63300	191000 42900	1.47		3460000 778000	LL584449	LL584410

⁽¹⁾Based on 1 x 10⁶ revolutions L₁₀ life, for the ISO life-calculation method.

⁽²⁾Consult your Timken engineer for instructions on use or review the Timken Engineering Manual on timken.com/catalogs.

⁽³⁾Based on 90 x 10⁶ revolutions L₁₀ life, for The Timken Company life-calculation method. C₉₀ and C_{a90} are radial and thrust values.

Bearing Dimensions											Geometry Factors			Bearing Weight
Width B	Width C	Eff. Ctr. a ⁽⁴⁾	Shaft			Housing			Cage		G ₁	G ₂	C _g	
			Max Shaft Fillet Radius R ⁽⁵⁾	Backing Shoulder Dia. d _a	mm in.	Max Housing Fillet Radius r ⁽⁵⁾	Backing Shoulder Dia. D _a	mm in.	A _a ⁽⁶⁾	A _b ⁽⁷⁾				
mm in.	mm in.	mm in.	mm in.	mm in.	mm in.	mm in.	mm in.	mm in.	mm in.	mm in.			kg lbs.	
92.075 3.6250	69.850 2.7500	54.1 2.13	6.4 0.25	714.0 28.11	723.0 28.46	6.4 0.25	841.4 33.13	831.0 32.72	10.4 0.41	5.9 0.23	11844.1	1202.6	0.3119	134.15 295.74
63.500 2.5000	50.800 2.0000	54.6 2.15	3.3 0.13	717.0 28.23	720.0 28.35	3.3 0.13	795.6 31.32	792.0 31.18	7.2 0.28	-1.8 -0.07	9937.5	2090.8	0.2738	54.75 120.72
82.550 3.2500	60.325 2.3750	53.6 2.11	6.4 0.25	741.0 29.17	750.0 29.53	6.4 0.25	877.0 34.53	873.0 34.37	12.9 0.51	7.2 0.29	11122.5	1282.2	0.2952	132.52 292.15
80.962 3.1875	60.325 2.3750	55.1 2.17	5.5 0.22	750.0 29.53	756.0 29.76	6.4 0.25	877.0 34.53	873.0 34.37	11.3 0.44	7.2 0.29	11122.5	1282.2	0.2952	122.27 269.55
31.750 1.2500	25.400 1.0000	86.9 3.42	3.5 0.14	753.1 29.65	753.1 29.65	3.3 0.13	822.0 32.36	807.0 31.77	0.3 0.01	0.1 0.01	6526.9	3683.4	0.2436	20.39 44.93
80.962 3.1875	66.675 2.6250	63.5 2.50	6.4 0.25	780.0 30.71	789.0 31.06	3.3 0.13	923.5 36.36	921.0 36.26	14.3 0.56	10.5 0.42	12456.8	1880.8	0.3116	152.15 335.45
160.338 6.3125	123.000 4.8425	6.1 0.24	6.4 0.25	786.0 30.94	792.0 31.18	6.4 0.25	952.4 37.50	936.0 36.85	15.0 0.59	6.2 0.25	20904.8	1142.9	0.3534	329.67 726.81
160.338 6.3125	123.000 4.8425	6.1 0.24	6.4 0.25	786.0 30.94	792.0 31.18	6.4 0.25	952.4 37.50	936.0 36.85	19.1 0.75	4.2 0.17	20571.2	1126.8	0.3514	321.90 709.67
69.850 2.7500	50.800 2.0000	62.2 2.45	3.3 0.13	777.0 30.59	783.0 30.83	3.3 0.13	858.0 33.78	855.0 33.66	7.3 0.28	4.7 0.19	12883.1	1729.9	0.3070	68.81 151.73
88.900 3.5000	72.000 2.8346	34.5 1.36	3.3 0.13	780.0 30.71	783.0 30.83	3.3 0.13	872.0 34.33	864.0 34.02	4.6 0.18	6.1 0.24	16116.5	2023.1	0.3102	89.26 196.78
63.500 2.5000	50.800 2.0000	69.6 2.74	3.3 0.13	780.0 30.71	783.0 30.83	3.3 0.13	858.3 33.79	855.0 33.66	7.6 0.30	-1.1 -0.04	11527.7	2694.6	0.2945	62.42 137.64
69.850 2.7500	50.800 2.0000	63.2 2.49	3.3 0.13	780.0 30.71	783.0 30.83	3.3 0.13	858.3 33.79	855.0 33.66	13.9 0.55	-1.1 -0.04	11527.7	2694.6	0.2945	65.86 145.22
69.850 2.7500	50.800 2.0000	62.2 2.45	3.3 0.13	780.0 30.71	783.0 30.83	3.3 0.13	858.0 33.78	855.0 33.66	7.3 0.28	4.7 0.19	12883.1	1729.9	0.3070	67.39 148.59
88.900 3.5000	72.000 2.8346	34.5 1.36	3.3 0.13	780.0 30.71	783.0 30.83	3.3 0.13	872.0 34.33	864.0 34.02	4.6 0.18	6.1 0.24	16116.5	2023.1	0.3102	87.53 192.96
80.962 3.1875	66.675 2.6250	63.5 2.50	6.4 0.25	789.0 31.06	798.0 31.42	3.3 0.13	923.5 36.36	921.0 36.26	14.3 0.56	10.5 0.42	12456.8	1880.8	0.3116	142.57 314.33
80.962 3.1875	66.675 2.6250	63.5 2.50	6.4 0.25	798.0 31.42	810.0 31.89	3.3 0.13	923.5 36.36	921.0 36.26	14.3 0.56	10.5 0.42	12456.8	1880.8	0.3116	135.30 298.27
58.738 2.3125	41.275 1.6250	79.0 3.11	3.5 0.14	819.0 32.24	822.0 32.36	3.3 0.13	894.0 35.20	888.0 34.96	7.9 0.31	3.2 0.13	12417.2	2699.6	0.3058	52.23 115.17

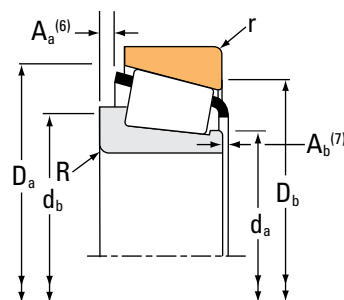
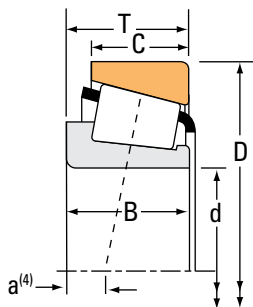
(4) Negative value indicates effective center inside cone (inner-ring) backface.
 (5) These maximum fillet radii will be cleared by the bearing corners.
 (6) Negative value indicates cage extends beyond cone (inner-ring) backface.
 (7) Negative value indicates cage that does not extend beyond cone (inner-ring) front face.

Continued on next page.

TAPERED ROLLER BEARINGS

SINGLE-ROW • TYPE TS

TYPE TS



Bearing Dimensions			Load Ratings							Part Number			
Bore d	O.D. D	Width T	Dynamic ⁽¹⁾		Factors ⁽²⁾		Dynamic ⁽³⁾		Factors ⁽²⁾		Static C ₀	Inner	Outer
			C ₁	e	Y	C ₉₀	C _{a90}	K	N	N			
mm in.	mm in.	mm in.	N lbf			N lbf	N lbf		N lbf		N lbf		
825.500 32.5000	1041.400 41.0000	93.662 3.6875	2530000 569000	0.44	1.37	657000 148000	492000 111000	1.33	5930000 1330000			EE763325	763410
836.612 32.9375	1041.400 41.0000	93.662 3.6875	2530000 569000	0.44	1.37	657000 148000	492000 111000	1.33	5930000 1330000			EE763329	763410
838.200 33.0000	1041.400 41.0000	93.662 3.6875	2530000 569000	0.44	1.37	657000 148000	492000 111000	1.33	5930000 1330000			EE763330	763410
857.250 33.7500	1092.200 43.0000	120.650 4.7500	2910000 654000	0.56	1.08	754000 169000	719000 162000	1.05	7630000 1710000			EE157337	157430
863.600 34.0000	1130.300 44.5000	174.625 6.8750	6520000 1470000	0.33	1.80	1690000 380000	963000 216000	1.76	17400000 3920000			LM286249	LM286210
887.000 34.9213	1123.950 44.2500	120.650 4.7500	2920000 655000	0.58	1.04	756000 170000	745000 167000	1.01	7740000 1740000			EE158349	158442
889.000 35.0000	1123.950 44.2500	120.650 4.7500	2920000 655000	0.58	1.04	756000 170000	745000 167000	1.01	7740000 1740000			EE158350	158442
928.000 36.5354	1060.000 41.7323	92.000 3.6220	2850000 641000	0.33	1.80	740000 166000	421000 94700	1.76	9330000 2100000			JL286948	JL286910
928.000 36.5354	1060.000 41.7323	92.000 3.6220	2660000 599000	0.33	1.80	691000 155000	393000 88400	1.76	8460000 1900000			JL286948H	JL286910
930.000 36.6142	1060.000 41.7323	92.000 3.6220	2850000 641000	0.33	1.80	740000 166000	421000 94700	1.76	9330000 2100000			JL286949	JL286910
930.000 36.6142	1060.000 41.7323	92.000 3.6220	2660000 599000	0.33	1.80	691000 155000	393000 88400	1.76	8460000 1900000			JL286949H	JL286910
946.150 37.2500	1194.435 47.0250	136.525 5.3750	6330000 1420000	0.37	1.61	1640000 369000	1050000 235000	1.57	14200000 3190000			NP957630	NP980281
977.900 38.5000	1130.300 44.5000	66.675 2.6250	1670000 375000	0.44	1.38	433000 97300	323000 72700	1.34	5290000 1190000			LL687949	LL687910
1016.000 40.0000	1270.000 50.0000	101.600 4.0000	2840000 640000	0.49	1.22	738000 166000	622000 140000	1.19	8030000 1800000			EE168400	168500
1063.625 41.8750	1219.200 48.0000	65.088 2.5625	1720000 386000	0.48	1.26	445000 100000	362000 81400	1.23	5660000 1270000			LL788345	LL788310
1066.800 42.0000	1219.200 48.0000	65.088 2.5625	1720000 386000	0.48	1.26	445000 100000	362000 81400	1.23	5660000 1270000			LL788349	LL788310
1066.800 42.0000	1320.800 52.0000	95.250 3.7500	2670000 599000	0.57	1.05	691000 155000	676000 152000	1.02	6990000 1570000			EE776420	776520

⁽¹⁾Based on 1 x 10⁶ revolutions L₁₀ life, for the ISO life-calculation method.

⁽²⁾Consult your Timken engineer for instructions on use or review the Timken Engineering Manual on timken.com/catalogs.

⁽³⁾Based on 90 x 10⁶ revolutions L₁₀ life, for The Timken Company life-calculation method. C₉₀ and C_{a90} are radial and thrust values.

Bearing Dimensions											Geometry Factors			Bearing Weight
Width B	Width C	Eff. Ctr. a ⁽⁴⁾	Shaft			Housing			Cage		G ₁	G ₂	C _g	
			Max Shaft Fillet Radius R ⁽⁵⁾	Backing Shoulder Dia. d _a	Backing Shoulder Dia. d _b	Max Housing Fillet Radius r ⁽⁵⁾	Backing Shoulder Dia. D _a	Backing Shoulder Dia. D _b	A _a ⁽⁶⁾	A _b ⁽⁷⁾				
mm in.	mm in.	mm in.	mm in.	mm in.	mm in.	mm in.	mm in.	mm in.	mm in.	mm in.				kg lbs.
88.900 3.5000	66.675 2.6250	83.1 3.27	6.4 0.25	861.0 33.90	867.0 34.13	6.4 0.25	1000.9 39.41	996.0 39.21	16.1 0.63	4.8 0.19	14677.1	1745.2	0.3374	173.44 382.38
88.900 3.5000	66.675 2.6250	83.1 3.27	6.4 0.25	867.0 34.13	876.0 34.49	6.4 0.25	1000.9 39.41	996.0 39.21	16.1 0.63	4.8 0.19	14677.1	1745.2	0.3374	163.11 359.61
88.900 3.5000	66.675 2.6250	83.1 3.27	6.4 0.25	870.0 34.25	876.0 34.49	6.4 0.25	1000.9 39.41	996.0 39.21	16.1 0.63	4.8 0.19	14677.1	1745.2	0.3374	161.66 356.40
111.125 4.3750	76.200 3.0000	112.5 4.43	19.0 0.75	894.0 35.20	927.0 36.50	6.4 0.25	1047.4 41.23	1035.0 40.75	22.1 0.87	5.7 0.23	16109.7	1534.4	0.3769	236.94 522.39
185.738 7.3125	138.112 5.4375	14.2 0.56	9.7 0.38	906.0 35.67	915.0 36.02	12.7 0.50	1090.4 42.93	1065.0 41.93	14.6 0.57	-2.2 -0.08	28956.1	1086.1	0.3933	465.42 1026.07
111.125 4.3750	76.200 3.0000	124.2 4.89	19.0 0.75	927.0 36.50	957.0 37.68	6.4 0.25	1078.9 42.48	1060.0 41.73	22.1 0.87	6.2 0.25	16994.2	1630.2	0.3871	249.38 549.80
111.125 4.3750	76.200 3.0000	124.2 4.89	19.0 0.75	927.0 36.50	957.0 37.68	6.4 0.25	1078.9 42.48	1060.0 41.73	22.1 0.87	6.2 0.25	16994.2	1630.2	0.3871	249.38 549.80
90.000 3.5433	76.000 2.9921	59.9 2.36	3.3 0.13	951.0 37.44	954.0 37.56	3.3 0.13	1040.0 40.94	1030.0 40.55	5.4 0.21	6.3 0.25	29812.0	4331.9	0.3902	121.25 267.32
90.000 3.5433	76.000 2.9921	59.9 2.36	3.3 0.13	951.0 37.44	954.0 37.56	3.3 0.13	1040.0 40.94	1030.0 40.55	3.5 0.14	8.4 0.33	27827.6	4055.4	0.3807	120.21 265.02
90.000 3.5433	76.000 2.9921	59.9 2.36	3.3 0.13	951.0 37.44	954.0 37.56	3.3 0.13	1040.0 40.94	1030.0 40.55	5.4 0.21	6.0 0.24	29812.0	4331.9	0.3902	119.25 262.78
90.000 3.5433	76.000 2.9921	59.9 2.36	3.3 0.13	951.0 37.44	954.0 37.56	3.3 0.13	1040.0 40.94	1030.0 40.55	3.5 0.14	8.4 0.33	27827.6	4055.4	0.3807	118.18 260.54
133.985 5.2750	110.109 4.3350	58.9 2.32	12.7 0.50	981.0 38.62	1000.0 39.37	12.7 0.50	1157.5 45.57	1135.1 44.69	5.9 0.23	9.3 0.37	26604.7	1717.6	0.3945	356.00 784.86
63.500 2.5000	47.625 1.8750	114.8 4.52	6.4 0.25	1005.0 39.57	1010.0 39.76	6.4 0.25	1100.4 43.32	1095.0 43.11	7.9 0.31	5.0 0.20	18937.3	3190.6	0.3631	101.90 224.68
101.600 4.0000	66.675 2.6250	127.8 5.03	9.7 0.38	1055.0 41.54	1070.0 42.13	9.7 0.38	1214.1 47.80	1210.0 47.64	21.0 0.83	-0.7 -0.03	22398.3	3110.1	0.4018	266.85 588.34
65.088 2.5625	42.862 1.6875	142.5 5.61	3.3 0.13	1085.0 42.72	1090.0 42.91	3.3 0.13	1188.8 46.80	1185.0 46.65	7.9 0.31	3.8 0.15	22182.4	4652.2	0.3922	109.42 241.24
65.088 2.5625	42.862 1.6875	142.5 5.61	3.3 0.13	1090.0 42.91	1090.0 42.91	3.3 0.13	1188.8 46.80	1185.0 46.65	7.9 0.31	3.8 0.15	22182.4	4652.2	0.3922	106.72 235.27
88.900 3.5000	69.850 2.7500	175.8 6.92	6.4 0.25	1115.0 43.90	1115.0 43.90	6.4 0.25	1273.5 50.14	1260.0 49.61	15.5 0.61	4.9 0.20	23201.8	2946.7	0.4231	268.22 591.29

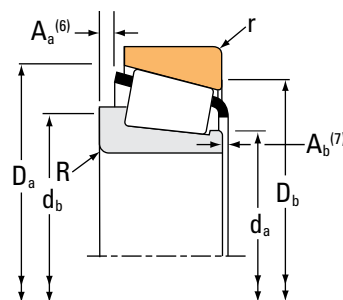
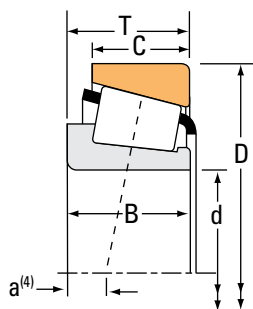
(4) Negative value indicates effective center inside cone (inner-ring) backface.
 (5) These maximum fillet radii will be cleared by the bearing corners.
 (6) Negative value indicates cage extends beyond cone (inner-ring) backface.
 (7) Negative value indicates cage that does not extend beyond cone (inner-ring) front face.

Continued on next page.

TAPERED ROLLER BEARINGS

SINGLE-ROW • TYPE TS

TYPE TS



Bearing Dimensions			Load Ratings							Part Number		
Bore d	O.D. D	Width T	Dynamic ⁽¹⁾		Factors ⁽²⁾		Dynamic ⁽³⁾		Factors ⁽²⁾	Static	Inner	Outer
			C ₁	e	Y	C ₉₀	C _{a90}	K	C ₀			
mm in.	mm in.	mm in.	N lbf			N lbf	N lbf			N lbf		
1092.200 43.0000	1320.800 52.0000	* *	2670000 599000	0.57	1.05	691000 155000	676000 152000	1.02		6990000 1570000	EE776430	776520
1155.700 45.5000	1435.100 56.5000	120.650 4.7500	4040000 908000	0.36	1.66	1050000 235000	647000 146000	1.62		13000000 2920000	EE277455	277565
1270.000 50.0000	1435.100 56.5000	69.850 2.7500	1840000 414000	0.57	1.05	478000 107000	467000 105000	1.02		6650000 1500000	LL889049	LL889010
1562.100 61.5000	1806.575 71.1250	127.000 5.0000	4540000 1020000	0.47	1.27	1180000 265000	955000 215000	1.23		16800000 3770000	EE299615	299711

⁽¹⁾Based on 1×10^6 revolutions L_{10} life, for the ISO life-calculation method.

⁽²⁾Consult your Timken engineer for instructions on use or review the Timken Engineering Manual on timken.com/catalogs.

⁽³⁾Based on 90×10^6 revolutions L_{10} life, for The Timken Company life-calculation method. C_{90} and C_{a90} are radial and thrust values.

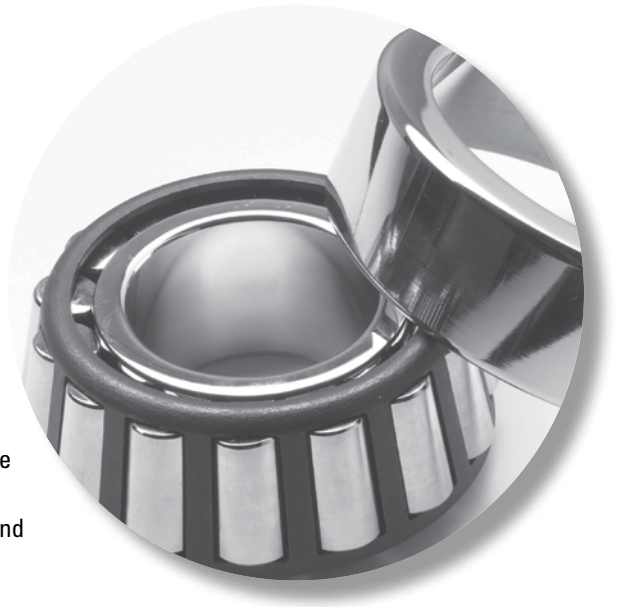
^(*)Contact your Timken engineer for details.

Bearing Dimensions											Geometry Factors			Bearing Weight
Width B	Width C	Eff. Ctr. a ⁽⁴⁾	Shaft			Housing			Cage		G ₁	G ₂	C _g	
			Max Shaft Fillet Radius R ⁽⁵⁾	Backing Shoulder Dia. d _a	Backing Shoulder Dia. d _b	Max Housing Fillet Radius r ⁽⁵⁾	Backing Shoulder Dia. D _a	Backing Shoulder Dia. D _b	A _a ⁽⁶⁾	A _b ⁽⁷⁾				
mm in.	mm in.	mm in.	mm in.	mm in.	mm in.	mm in.	mm in.	mm in.	mm in.	mm in.				kg lbs.
88.900 3.5000	69.850 2.7500	175.8 6.92	6.4 0.25	1130.0 44.49	1135.0 44.69	6.4 0.25	1273.5 50.14	1260.0 49.61	15.5 0.61	4.9 0.20	23201.8	2946.7	0.4231	238.26 525.24
120.650 4.7500	95.250 3.7500	87.9 3.46	6.4 0.25	1195.0 47.05	1205.0 47.44	6.4 0.25	1370.0 53.94	1370.0 53.94	15.6 0.61	1.6 0.07	40981.4	4107.8	0.4449	432.22 952.86
65.088 2.5625	47.625 1.8750	216.9 8.54	6.4 0.25	1300.0 51.18	1305.0 51.38	6.4 0.25	1403.2 55.24	1395.0 54.92	6.7 0.26	5.9 0.23	31422.7	5654.9	0.4637	147.09 324.30
123.825 4.8750	85.725 3.3750	190.5 7.50	9.7 0.38	1600.0 62.99	1615.0 63.58	9.7 0.38	1757.5 69.19	1700.0 66.93	23.5 0.92	5.6 0.22	69875.1	7454.3	0.5753	477.64 1053.01

(4) Negative value indicates effective center inside cone (inner-ring) backface.
 (5) These maximum fillet radii will be cleared by the bearing corners.
 (6) Negative value indicates cage extends beyond cone (inner-ring) backface.
 (7) Negative value indicates cage that does not extend beyond cone (inner-ring) front face.

***IsoClass™ METRIC
30000 SERIES
BEARINGS***

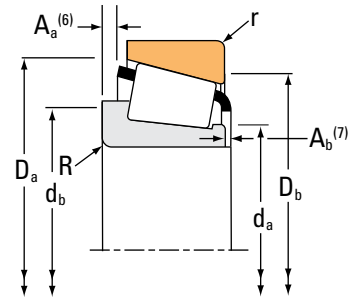
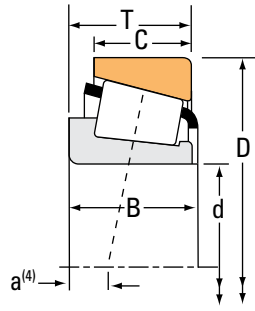
- Timken offers a comprehensive range of metric part numbers in the 30000 series.
- Consult your Timken engineer before making a final bearing selection to help ensure suitability, availability and the most cost-effective application.



TAPERED ROLLER BEARINGS

SINGLE-ROW • IsoClass

IsoClass



Bearing Dimensions			Load Ratings							Part Number		
Bore d	O.D. D	Width T	Dynamic ⁽¹⁾		Factors ⁽²⁾		Dynamic ⁽³⁾		Factors ⁽²⁾		Static C ₀	Assembly Inner/Outer
			C ₁	e	Y	C ₉₀	C _{a90}	K				
mm in.	mm in.	mm in.	N lbf			N lbf	N lbf				N lbf	
15.000 0.5906	42.000 1.6535	14.250 0.5610	26000 5850	0.29	2.11	6750 1520	3290 740	2.05	22200 4980		30302	
17.000 0.6693	40.000 1.5748	13.250 0.5217	21300 4800	0.35	1.74	5530 1240	3270 735	1.69	19900 4460		30203	
17.000 0.6693	47.000 1.8504	15.250 0.6004	32700 7360	0.29	2.11	8480 1910	4140 931	2.05	28400 6390		30303	
20.000 0.7874	42.000 1.6535	15.000 0.5906	32900 7390	0.37	1.60	8520 1920	5460 1230	1.56	29400 6600		32004X	
20.000 0.7874	42.000 1.6535	15.000 0.5906	32900 7390	0.37	1.60	8520 1920	5460 1230	1.56	29400 6600		XAA32004X/YAA32004X	
20.000 0.7874	52.000 2.0472	16.250 0.6398	38500 8660	0.30	2.00	9980 2240	5130 1150	1.95	34500 7760		30304	
20.000 0.7874	52.000 2.0472	22.250 0.8760	55200 12400	0.30	2.00	14300 3220	7350 1650	1.95	55000 12400		32304	
25.000 0.9843	47.000 1.8504	15.000 0.5906	36500 8200	0.43	1.39	9460 2130	6970 1570	1.36	35400 7960		XAA32005X/YAA32005X	
25.000 0.9843	52.000 2.0472	19.250 0.7579	47000 10600	0.58	1.03	12200 2740	12200 2740	1.00	46300 10400		32205-B/YAA32205-B	
25.000 0.9843	52.000 2.0472	19.250 0.7579	47000 10600	0.58	1.03	12200 2740	12200 2740	1.00	46300 10400		32205-B	
25.000 0.9843	52.000 2.0472	22.000 0.8661	65400 14700	0.35	1.71	16900 3810	10200 2290	1.66	63600 14300		33205	
25.000 0.9843	52.000 2.0472	16.250 0.6398	36900 8300	0.37	1.60	9570 2150	6150 1380	1.56	38300 8620		30205	
25.000 0.9843	62.000 2.4409	25.250 0.9941	72400 16300	0.30	2.00	18800 4220	9640 2170	1.95	72400 16300		32305	
30.000 1.1811	55.000 2.1654	17.000 0.6693	46500 10400	0.43	1.39	12000 2710	8870 1990	1.36	45300 10200		32006X	
30.000 1.1811	62.000 2.4409	17.250 0.6791	43800 9840	0.37	1.60	11400 2550	7290 1640	1.56	43800 9860		30206	
30.000 1.1811	62.000 2.4409	21.250 0.8366	55800 12500	0.56	1.07	14500 3250	13900 3130	1.04	62300 14000		32206-B	
30.000 1.1811	62.000 2.4409	21.250 0.8366	64100 14400	0.37	1.60	16600 3740	10700 2400	1.56	71900 16200		32206	

⁽¹⁾Based on 1 x 10⁶ revolutions L₁₀ life, for the ISO life-calculation method.

⁽²⁾Consult your Timken engineer for instructions on use or review the Timken Engineering Manual on timken.com/catalogs.

⁽³⁾Based on 90 x 10⁶ revolutions L₁₀ life, for The Timken Company life-calculation method. C₉₀ and C_{a90} are radial and thrust values.

Bearing Dimensions											Geometry Factors			Bearing Weight
Width B	Width C	Eff. Ctr. a ⁽⁴⁾	Shaft			Housing			Cage		G ₁	G ₂	C _g	
			Max Shaft Fillet Radius R ⁽⁵⁾	Backing Shoulder Dia. d _a d _b		Max Housing Fillet Radius r ⁽⁵⁾	Backing Shoulder Dia. D _a D _b		A _a ⁽⁶⁾	A _b ⁽⁷⁾				
mm in.	mm in.	mm in.	mm in.	mm in.	mm in.	mm in.	mm in.	mm in.	mm in.	mm in.			kg lbs.	
13.000 0.5118	11.000 0.4331	-4.6 -0.18	1.0 0.04	19.0 0.75	20.5 0.81	1.0 0.04	38.5 1.52	36.5 1.44	-0.4 -0.02	2.1 0.09	4.3	4.6	0.0375	0.11 0.22
12.000 0.4724	11.000 0.4331	-3.6 -0.14	1.0 0.04	21.0 0.83	22.0 0.87	1.0 0.04	37.0 1.46	35.0 1.38	0.1 0.00	1.6 0.07	4.2	6.0	0.0398	0.08 0.18
14.000 0.5512	12.000 0.4724	-4.8 -0.19	1.0 0.04	21.5 0.85	22.5 0.89	1.0 0.04	43.0 1.69	41.5 1.63	-0.3 -0.01	2.2 0.09	5.8	5.0	0.0412	0.14 0.29
15.000 0.5906	12.000 0.4724	-4.6 -0.18	0.6 0.03	25.5 1.00	26.5 1.04	0.6 0.03	39.5 1.56	37.0 1.46	0.4 0.01	1.5 0.06	6.2	6.1	0.0469	0.10 0.21
15.000 0.5906	12.000 0.4724	-4.6 -0.18	2.0 0.08	25.5 1.00	29.0 1.14	1.0 0.04	39.5 1.56	36.5 1.44	0.4 0.01	1.5 0.06	6.2	6.1	0.0469	0.10 0.21
15.000 0.5906	13.000 0.5118	-4.8 -0.19	1.5 0.06	24.5 0.96	27.0 1.06	1.5 0.06	47.5 1.87	45.5 1.79	-0.6 -0.03	2.6 0.11	7.5	5.5	0.0458	2.66 0.38
21.000 0.8268	18.000 0.7087	-7.9 -0.31	1.5 0.06	27.0 1.06	31.0 1.22	1.5 0.06	47.5 1.87	44.0 1.73	-0.1 -0.01	1.8 0.07	10.3	5.9	0.0512	0.24 0.53
15.000 0.5906	11.500 0.4528	-3.3 -0.13	3.3 0.13	30.0 1.18	37.0 1.46	1.0 0.04	44.5 1.75	41.0 1.61	0.5 0.02	1.2 0.05	8.6	8.7	0.0546	0.11 0.25
18.000 0.7087	15.000 0.5906	-3.0 -0.12	1.0 0.04	31.0 1.22	36.0 1.42	2.0 0.08	49.5 1.95	43.0 1.69	1.7 0.06	1.6 0.07	10.2	9.1	0.0637	0.19 0.42
18.000 0.7087	15.000 0.5906	-3.0 -0.12	1.0 0.04	31.0 1.22	36.0 1.42	1.0 0.04	49.5 1.95	43.5 1.71	1.7 0.06	1.6 0.07	10.2	9.1	0.0637	0.19 0.42
22.000 0.8661	18.000 0.7087	-7.6 -0.30	1.0 0.04	30.5 1.20	34.0 1.34	1.0 0.04	49.0 1.93	44.5 1.75	0.6 0.02	2.0 0.08	13.4	8.6	0.0594	0.23 0.50
15.000 0.5906	13.000 0.5118	-3.8 -0.15	1.0 0.04	31.0 1.22	32.5 1.28	1.0 0.04	48.5 1.91	45.5 1.79	0.4 0.01	1.9 0.08	9.0	8.0	0.0529	0.15 0.34
24.000 0.9449	20.000 0.7874	-9.7 -0.38	1.5 0.06	31.5 1.24	35.0 1.38	1.5 0.06	57.0 2.24	54.0 2.13	2.1 0.08	2.3 0.09	15.1	7.2	0.0580	0.37 0.81
17.000 0.6693	13.000 0.5118	-3.3 -0.13	1.0 0.04	36.0 1.42	37.5 1.48	1.0 0.04	52.0 2.05	49.0 1.93	0.9 0.03	1.3 0.06	12.1	10.5	0.0611	0.18 0.38
16.000 0.6299	14.000 0.5512	-3.3 -0.13	1.0 0.04	35.0 1.38	36.0 1.42	1.0 0.04	58.0 2.28	55.0 2.17	0.2 0.00	2.4 0.10	11.9	9.4	0.0577	0.23 0.51
20.000 0.7874	17.000 0.6693	-3.3 -0.13	1.0 0.04	36.5 1.44	39.5 1.56	1.0 0.04	59.0 2.32	53.0 2.09	1.6 0.06	2.9 0.12	14.1	8.9	0.0700	0.30 0.65
20.000 0.7874	17.000 0.6693	-5.6 -0.22	1.0 0.04	37.0 1.46	43.0 1.69	1.0 0.04	59.0 2.32	54.0 2.13	0.7 0.03	2.6 0.11	16.8	10.9	0.0652	0.29 0.66

⁽⁴⁾Negative value indicates effective center inside cone (inner-ring) backface.

⁽⁵⁾These maximum fillet radii will be cleared by the bearing corners.

⁽⁶⁾Negative value indicates cage extends beyond cone (inner-ring) backface.

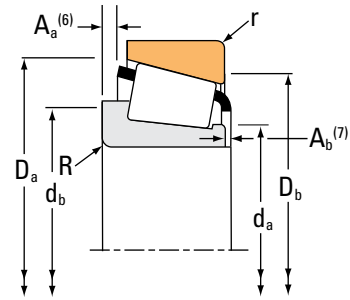
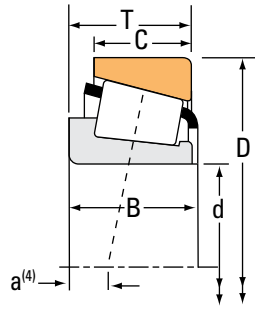
⁽⁷⁾Negative value indicates cage that does not extend beyond cone (inner-ring) front face.

Continued on next page.

TAPERED ROLLER BEARINGS

SINGLE-ROW • IsoClass

IsoClass



Bearing Dimensions			Load Ratings							Part Number		
Bore d	O.D. D	Width T	Dynamic ⁽¹⁾		Factors ⁽²⁾		Dynamic ⁽³⁾		Factors ⁽²⁾		Static C ₀	Assembly Inner/Outer
			C ₁	e	Y	C ₉₀	C _{a90}	K				
mm in.	mm in.	mm in.	N lbf			N lbf	N lbf			N lbf		
30.000 1.1811	72.000 2.8346	20.750 0.8169	67700 15200	0.31	1.90	17500 3940	9460 2130	1.85	65300 14700	30306		
30.000 1.1811	72.000 2.8346	28.750 1.1319	87600 19700	0.31	1.90	22700 5110	12300 2750	1.85	89800 20200	32306		
35.000 1.3780	62.000 2.4409	18.000 0.7087	56500 12700	0.45	1.32	14600 3290	11400 2560	1.29	57600 12900	32007X		
35.000 1.3780	72.000 2.8346	24.250 0.9547	74900 16800	0.37	1.60	19400 4370	12500 2800	1.56	82300 18500	32207		
35.000 1.3780	72.000 2.8346	24.250 0.9547	67900 15300	0.58	1.03	17600 3960	17500 3940	1.01	86700 19500	32207-B		
35.000 1.3780	80.000 3.1496	22.750 0.8957	87200 19600	0.31	1.90	22600 5080	12200 2740	1.85	86100 19300	30307		
40.000 1.5748	68.000 2.6772	19.000 0.7480	65800 14800	0.38	1.58	17100 3840	11100 2490	1.54	71600 16100	32008X		
40.000 1.5748	68.000 2.6772	19.000 0.7480	65800 14800	0.38	1.58	17100 3840	11100 2490	1.54	71600 16100	XAA32008X/32008X		
40.000 1.5748	75.000 2.9528	26.000 1.0236	104000 23400	0.36	1.69	27000 6080	16500 3700	1.64	105000 23600	XAA33108/33108		
40.000 1.5748	80.000 3.1496	24.750 0.9744	95900 21600	0.37	1.60	24900 5590	16000 3590	1.56	86500 19400	32208		
40.000 1.5748	80.000 3.1496	32.000 1.2598	143000 32200	0.36	1.68	37100 8350	22700 5110	1.63	144000 32400	33208		
40.000 1.5748	90.000 3.5433	25.250 0.9941	117000 26300	0.35	1.74	30300 6820	17900 4030	1.69	102000 23000	30308		
40.000 1.5748	90.000 3.5433	25.250 0.9941	101000 22700	0.83	0.73	26200 5890	37000 8320	0.71	88100 19800	31308		
40.000 1.5748	90.000 3.5433	35.250 1.3878	157000 35300	0.55	1.10	40700 9140	38000 8540	1.07	160000 36100	32308-B		
40.000 1.5748	90.000 3.5433	35.250 1.3878	157000 35300	0.55	1.10	40700 9140	38000 8540	1.07	160000 36100	XBA32308-B/32308-B		
41.000 1.6142	68.000 2.6772	19.000 0.7480	67900 15300	0.38	1.58	17600 3960	11400 2570	1.54	74900 16800	XKA32008XF/32008XZ		
45.000 1.7717	75.000 2.9528	20.000 0.7874	78700 17700	0.39	1.53	20400 4590	13700 3080	1.49	84300 19000	32009X		

⁽¹⁾Based on 1 x 10⁶ revolutions L₁₀ life, for the ISO life-calculation method.

⁽²⁾Consult your Timken engineer for instructions on use or review the Timken Engineering Manual on timken.com/catalogs.

⁽³⁾Based on 90 x 10⁶ revolutions L₁₀ life, for The Timken Company life-calculation method. C₉₀ and C_{a90} are radial and thrust values.

Bearing Dimensions											Geometry Factors			Bearing Weight
Width B	Width C	Eff. Ctr. a ⁽⁴⁾	Shaft			Housing			Cage		G ₁	G ₂	C _g	
			Max Shaft Fillet Radius R ⁽⁵⁾	Backing Shoulder Dia. d _a d _b		Max Housing Fillet Radius r ⁽⁵⁾	Backing Shoulder Dia. D _a D _b		A _a ⁽⁶⁾	A _b ⁽⁷⁾				
mm in.	mm in.	mm in.	mm in.	mm in.	mm in.	mm in.	mm in.	mm in.	mm in.	mm in.				kg lbs.
19.000 0.7480	16.000 0.6299	-5.6 -0.22	1.5 0.06	38.0 1.50	40.0 1.57	1.5 0.06	67.0 2.64	63.0 2.48	1.2 0.04	3.3 0.13	16.8	10.3	0.0609	0.39 0.88
27.000 1.0630	23.000 0.9055	-10.7 -0.42	1.5 0.06	37.0 1.46	40.5 1.59	1.5 0.06	66.0 2.60	62.0 2.44	2.9 0.11	2.8 0.11	20.6	8.6	0.0654	0.56 1.23
18.000 0.7087	14.000 0.5512	-2.5 -0.10	1.0 0.04	41.5 1.63	43.0 1.69	1.0 0.04	59.5 2.34	55.0 2.17	0.8 0.03	1.4 0.06	16.7	15.7	0.0691	0.22 0.50
23.000 0.9055	19.000 0.7480	-6.3 -0.25	1.5 0.06	41.5 1.63	43.5 1.71	1.5 0.06	67.0 2.64	63.0 2.48	1.9 0.07	1.8 0.07	21.5	11.4	0.0705	0.44 0.96
23.000 0.9055	19.000 0.7480	-2.8 -0.11	1.5 0.06	42.5 1.67	50.0 1.97	1.5 0.06	68.0 2.68	61.0 2.40	1.2 0.04	2.4 0.10	21.3	11.2	0.0810	0.47 1.02
21.000 0.8268	18.000 0.7087	-5.8 -0.23	2.0 0.08	43.5 1.71	46.5 1.83	1.5 0.06	75.0 2.95	72.0 2.83	0.5 0.02	4.0 0.16	22.9	10.1	0.0674	0.53 1.16
19.000 0.7480	14.500 0.5709	-3.8 -0.15	1.0 0.04	45.5 1.79	47.0 1.85	1.0 0.04	65.0 2.56	61.0 2.40	0.9 0.03	1.7 0.07	23.8	16.1	0.0732	0.27 0.61
19.000 0.7480	14.500 0.5709	-3.8 -0.15	3.5 0.14	45.5 1.79	52.1 2.05	1.0 0.04	65.0 2.56	61.0 2.40	0.9 0.03	1.7 0.07	23.8	16.1	0.0732	0.27 0.61
26.000 1.0236	20.500 0.8071	-7.6 -0.30	3.5 0.14	47.0 1.85	55.0 2.17	1.5 0.06	72.0 2.83	67.0 2.64	1.8 0.07	1.7 0.07	29.4	14.9	0.0771	0.50 1.09
23.000 0.9055	19.000 0.7480	-5.6 -0.22	1.5 0.06	46.0 1.81	48.5 1.91	1.5 0.06	75.0 2.95	71.0 2.80	1.6 0.06	2.5 0.10	25.0	11.4	0.0738	0.53 1.17
32.000 1.2598	25.000 0.9843	-10.9 -0.43	1.5 0.06	47.0 1.85	51.0 2.01	1.5 0.06	76.0 2.99	70.0 2.76	2.8 0.11	2.5 0.10	35.9	11.4	0.0827	0.73 1.61
23.000 0.9055	20.000 0.7874	-5.8 -0.23	2.0 0.08	46.5 1.83	50.0 1.97	1.5 0.06	84.0 3.31	80.0 3.15	1.8 0.07	2.8 0.11	30.1	11.6	0.0762	0.73 1.61
23.000 0.9055	17.000 0.6693	4.1 0.16	2.0 0.08	52.0 2.05	61.0 2.40	1.5 0.06	86.0 3.39	76.0 2.99	4.0 0.16	3.1 0.13	22.9	10.3	0.0910	0.73 1.59
33.000 1.2992	27.000 1.0630	-7.4 -0.29	2.0 0.08	49.0 1.93	58.0 2.28	1.5 0.06	84.0 3.31	76.0 2.99	3.5 0.13	3.4 0.14	38.1	14.0	0.0966	1.10 2.43
33.500 1.3189	27.000 1.0630	-7.4 -0.29	2.0 0.08	49.0 1.93	58.0 2.28	1.5 0.06	84.0 3.31	76.0 2.99	3.5 0.13	2.9 0.12	38.1	14.0	0.0966	1.10 2.43
21.000 0.8268	14.500 0.5709	-3.8 -0.15	2.0 0.08	46.0 1.81	50.0 1.97	1.0 0.04	65.0 2.56	61.0 2.40	0.0 0.00	0.0 0.00	24.5	16.6	0.0740	0.27 0.59
20.000 0.7874	15.500 0.6102	-3.3 -0.13	1.0 0.04	51.0 2.01	53.0 2.09	1.0 0.04	72.0 2.83	68.0 2.68	0.5 0.02	2.2 0.09	28.7	16.2	0.0788	0.34 0.76

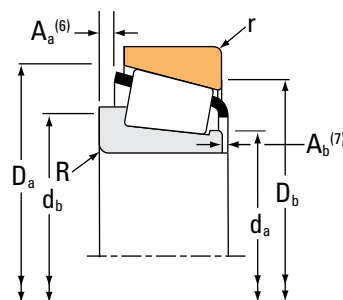
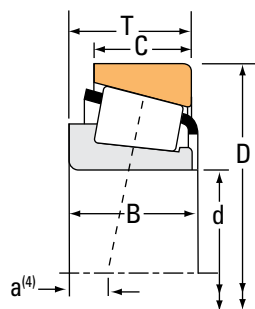
⁽⁴⁾Negative value indicates effective center inside cone (inner-ring) backface.
⁽⁵⁾These maximum fillet radii will be cleared by the bearing corners.
⁽⁶⁾Negative value indicates cage extends beyond cone (inner-ring) backface.
⁽⁷⁾Negative value indicates cage that does not extend beyond cone (inner-ring) front face.
^(*)Contact your Timken engineer for details.

Continued on next page.

TAPERED ROLLER BEARINGS

SINGLE-ROW • IsoClass

IsoClass



Bearing Dimensions			Load Ratings							Part Number		
Bore d	O.D. D	Width T	Dynamic ⁽¹⁾		Factors ⁽²⁾		Dynamic ⁽³⁾		Factors ⁽²⁾		Static C ₀	Assembly Inner/Outer
			C ₁	e	Y	C ₉₀	C _{a90}	K				
mm in.	mm in.	mm in.	N lbf			N lbf	N lbf			N lbf		
45.000 1.7717	75.000 2.9528	20.000 0.7874	78700 17700	0.39	1.53	20400 4590	13700 3080	1.49		84300 19000	XAA32009X/32009X	
45.000 1.7717	75.000 2.9528	20.000 0.7874	78700 17700	0.39	1.53	20400 4590	13700 3080	1.49		84300 19000	XAB-32009X/32009X	
45.000 1.7717	80.000 3.1496	26.000 1.0236	113000 25300	0.38	1.57	29200 6570	19200 4310	1.52		119000 26800	33109	
45.000 1.7717	85.000 3.3465	24.750 0.9744	104000 23300	0.40	1.48	26900 6050	18700 4190	1.44		98700 22200	32209	
45.000 1.7717	85.000 3.3465	32.000 1.2598	149000 33400	0.39	1.56	38500 8660	25400 5720	1.51		155000 34800	33209	
45.000 1.7717	85.000 3.3465	20.750 0.8169	94800 21300	0.40	1.48	24600 5520	17000 3830	1.44		89000 20000	30209	
45.000 1.7717	100.000 3.9370	27.250 1.0728	129000 29000	0.35	1.74	33500 7530	19800 4450	1.69		139000 31300	30309	
45.000 1.7717	100.000 3.9370	27.250 1.0728	125000 28200	0.83	0.73	32500 7300	45900 10300	0.71		113000 25400	31309	
45.000 1.7717	100.000 3.9370	38.250 1.5059	189000 42500	0.55	1.10	49000 11000	45800 10300	1.07		187000 42100	32309-B	
50.000 1.9685	80.000 3.1496	20.000 0.7874	82700 18600	0.42	1.42	21500 4820	15500 3490	1.38		92700 20800	XAA32010X/32010X	
50.000 1.9685	80.000 3.1496	20.000 0.7874	82700 18600	0.42	1.42	21500 4820	15500 3490	1.38		92700 20800	XAB-32010X/32010X	
50.000 1.9685	82.000 3.2283	21.500 0.8465	82700 18600	0.42	1.42	21500 4820	15500 3490	1.38		92700 20800	XAB-32010X/YKB-32010X	
50.000 1.9685	80.000 3.1496	20.000 0.7874	82700 18600	0.42	1.42	21500 4820	15500 3490	1.38		92700 20800	32010X	
50.000 1.9685	80.000 3.1496	20.000 0.7874	82700 18600	0.42	1.42	21500 4820	15500 3490	1.38		92700 20800	XAD32010X/32010X	
50.000 1.9685	80.000 3.1496	20.000 0.7874	82700 18600	0.42	1.42	21500 4820	15500 3490	1.38		92700 20800	XAE32010X/32010X	
50.000 1.9685	82.000 3.2283	21.500 0.8465	82700 18600	0.42	1.42	21500 4820	15500 3490	1.38		92700 20800	XAB-32010X/YKB-32010X	
50.000 1.9685	85.000 3.3465	26.000 1.0236	115000 25800	0.41	1.46	29700 6680	20900 4700	1.42		125000 28100	33110	

⁽¹⁾Based on 1×10^6 revolutions L_{10} life, for the ISO life-calculation method.

⁽²⁾Consult your Timken engineer for instructions on use or review the Timken Engineering Manual on timken.com/catalogs.

⁽³⁾Based on 90×10^6 revolutions L_{10} life, for The Timken Company life-calculation method. C_{90} and C_{a90} are radial and thrust values.

Bearing Dimensions											Geometry Factors			Bearing Weight
Width B	Width C	Eff. Ctr. a ⁽⁴⁾	Shaft			Housing			Cage		G ₁	G ₂	C _g	
			Max Shaft Fillet Radius R ⁽⁵⁾	Backing Shoulder Dia. d _a d _b		Max Housing Fillet Radius r ⁽⁵⁾	Backing Shoulder Dia. D _a D _b		A _a ⁽⁶⁾	A _b ⁽⁷⁾				
mm in.	mm in.	mm in.	mm in.	mm in.	mm in.	mm in.	mm in.	mm in.	mm in.	mm in.				kg lbs.
20.000 0.7874	15.500 0.6102	-3.3 -0.13	3.0 0.12	51.0 2.01	57.0 2.24	1.0 0.04	72.0 2.83	68.0 2.68	0.5 0.02	2.2 0.09	28.7	16.2	0.0788	0.34 0.76
20.000 0.7874	15.500 0.6102	-3.3 -0.13	0.0 0.00	51.0 2.01	58.0 2.28	1.0 0.04	72.0 2.83	68.0 2.68	0.5 0.02	2.2 0.09	28.7	16.2	0.0788	0.33 0.75
26.000 1.0236	20.500 0.8071	-6.6 -0.26	1.5 0.06	52.0 2.05	55.0 2.17	1.5 0.06	76.0 2.99	71.0 2.80	1.9 0.07	1.7 0.07	35.7	16.5	0.0843	0.54 1.17
23.000 0.9055	19.000 0.7480	-4.3 -0.17	1.5 0.06	51.0 2.01	54.0 2.13	1.5 0.06	81.0 3.19	76.0 2.99	1.6 0.06	2.6 0.10	30.5	13.8	0.0809	0.58 1.27
32.000 1.2598	25.000 0.9843	-9.9 -0.39	1.5 0.06	52.0 2.05	57.0 2.24	1.5 0.06	81.0 3.19	74.0 2.91	2.9 0.11	2.5 0.10	41.9	14.5	0.0892	0.79 1.73
19.000 0.7480	16.000 0.6299	-2.5 -0.10	1.5 0.06	53.0 2.09	55.0 2.17	1.5 0.06	80.0 3.15	76.0 2.99	1.0 0.04	3.9 0.16	28.3	16.3	0.0789	0.49 1.08
25.000 0.9843	22.000 0.8661	-6.1 -0.24	2.0 0.08	56.0 2.20	59.0 2.32	1.5 0.06	93.0 3.66	89.0 3.50	0.7 0.02	4.0 0.16	41.9	18.4	0.0836	1.01 2.22
25.000 0.9843	18.000 0.7087	4.3 0.17	2.0 0.08	56.0 2.20	67.0 2.64	1.5 0.06	95.5 3.76	85.0 3.35	5.4 0.21	3.8 0.15	30.4	12.7	0.1001	0.94 2.07
36.000 1.4173	30.000 1.1811	-7.9 -0.31	2.0 0.08	54.0 2.13	68.0 2.68	1.5 0.06	95.0 3.74	84.0 3.31	3.5 0.14	1.8 0.08	45.0	17.2	0.1018	1.42 3.13
20.000 0.7874	15.500 0.6102	-2.0 -0.08	2.3 0.09	56.0 2.20	60.0 2.36	1.0 0.04	77.0 3.03	73.0 2.87	0.9 0.03	2.1 0.09	34.0	20.3	0.0853	0.36 0.82
20.000 0.7874	15.500 0.6102	-2.0 -0.08	3.0 0.12	55.0 2.17	62.0 2.44	1.0 0.04	77.0 3.03	73.0 2.87	0.9 0.03	2.1 0.09	34.0	20.3	0.0853	0.36 0.82
20.000 0.7874	17.000 0.6693	-2.0 -0.08	3.0 0.12	55.0 2.17	62.0 2.44	0.5 0.02	77.0 3.03	76.0 2.99	0.9 0.03	2.1 0.09	34.0	20.3	0.0853	0.41 0.93
20.000 0.7874	15.500 0.6102	-2.0 -0.08	1.0 0.04	56.0 2.20	58.0 2.28	1.0 0.04	77.0 3.03	73.0 2.87	0.9 0.03	2.1 0.09	34.0	20.3	0.0853	0.36 0.82
20.000 0.7874	15.500 0.6102	-2.0 -0.08	1.5 0.06	56.0 2.20	59.0 2.32	1.0 0.04	77.0 3.03	73.0 2.87	0.9 0.03	2.1 0.09	34.0	20.3	0.0853	0.36 0.82
20.000 0.7874	15.500 0.6102	-2.0 -0.08	0.3 0.01	55.0 2.17	56.0 2.20	1.0 0.04	77.0 3.03	73.0 2.87	0.9 0.03	2.1 0.09	34.0	20.3	0.0853	0.36 0.82
20.000 0.7874	17.000 0.6693	-2.0 -0.08	3.0 0.12	55.0 2.17	62.0 2.44	0.5 0.02	77.0 3.03	76.0 2.99	0.9 0.03	2.1 0.09	34.0	20.3	0.0853	0.41 0.93
26.000 1.0236	20.000 0.7874	-5.3 -0.21	1.5 0.06	57.0 2.24	61.0 2.40	1.5 0.06	82.0 3.23	76.0 2.99	2.3 0.09	1.7 0.07	40.6	20.7	0.0899	0.58 1.29

⁽⁴⁾Negative value indicates effective center inside cone (inner-ring) backface.

⁽⁵⁾These maximum fillet radii will be cleared by the bearing corners.

⁽⁶⁾Negative value indicates cage extends beyond cone (inner-ring) backface.

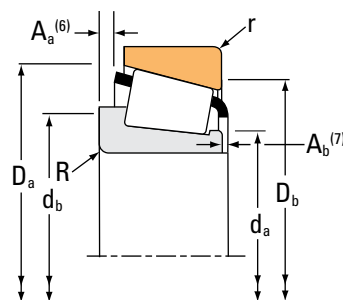
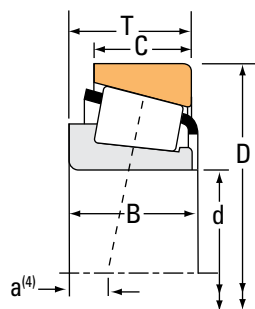
⁽⁷⁾Negative value indicates cage that does not extend beyond cone (inner-ring) front face.

Continued on next page.

TAPERED ROLLER BEARINGS

SINGLE-ROW • IsoClass

IsoClass



Bearing Dimensions			Load Ratings							Part Number		
Bore d	O.D. D	Width T	Dynamic ⁽¹⁾		Factors ⁽²⁾		Dynamic ⁽³⁾		Factors ⁽²⁾		Static C ₀	Assembly Inner/Outer
			C ₁	e	Y	C ₉₀	C _{a90}	K				
mm in.	mm in.	mm in.	N lbf			N lbf	N lbf		N lbf			
50.000 1.9685	90.000 3.5433	21.750 0.8563	79500 17900	0.42	1.43	20600 4630	14800 3330	1.39	87400 19700		30210	
50.000 1.9685	100.000 3.9370	33.500 1.3189	192000 43200	0.40	1.50	49800 11200	34100 7660	1.46	202000 45300		XLA33211/33211	
50.000 1.9685	110.000 4.3307	29.250 1.1516	142000 31900	0.35	1.74	36800 8270	21700 4890	1.69	150000 33800		30310	
50.000 1.9685	110.000 4.3307	29.250 1.1516	147000 33100	0.83	0.73	38200 8590	54000 12100	0.71	132000 29700		31310	
50.000 1.9685	110.000 4.3307	42.250 1.6634	187000 42000	0.35	1.74	48400 10900	28600 6430	1.69	211000 47500		32310	
50.000 1.9685	110.000 4.3307	42.250 1.6634	229000 51400	0.55	1.10	59300 13300	55400 12500	1.07	241000 54300		32310-B	
50.815 2.0006	100.000 3.9370	35.000 1.3780	192000 43200	0.40	1.50	49800 11200	34100 7660	1.46	202000 45300		XGA33211/33211	
52.000 2.0472	90.000 3.5433	21.750 0.8563	79500 17900	0.42	0.14	20600 4630	14800 3330	1.39	87400 19700		XGA30210/30210	
55.000 2.1654	90.000 3.5433	23.000 0.9055	112000 25300	0.41	1.48	29100 6550	20300 4560	1.44	126000 28300		32011X	
55.000 2.1654	90.000 3.5433	27.000 1.0630	118000 26500	0.31	1.92	30600 6870	16300 3670	1.87	141000 31700		33011	
55.000 2.1654	100.000 3.9370	22.750 0.8957	107000 24000	0.40	1.48	27700 6230	19200 4320	1.44	122000 27400		30211	
55.000 2.1654	100.000 3.9370	35.000 1.3780	192000 43200	0.40	1.50	49800 11200	34100 7660	1.46	202000 45300		33211	
55.000 2.1654	120.000 4.7244	31.500 1.2402	174000 39100	0.35	1.74	45100 10100	26600 5990	1.69	190000 42700		30311	
55.000 2.1654	120.000 4.7244	31.500 1.2402	172000 38700	0.83	0.73	44600 10000	63000 14200	0.71	157000 35300		31311	
55.000 2.1654	120.000 4.7244	45.500 1.7913	228000 51200	0.35	1.74	59100 13300	34900 7840	1.69	265000 59700		32311	
55.000 2.1654	120.000 4.7244	45.500 1.7913	223000 50100	0.55	1.10	57700 13000	54000 12100	1.07	286000 64300		32311-B	
60.000 2.3622	95.000 3.7402	23.000 0.9055	115000 25800	0.43	1.39	29700 6680	21900 4920	1.36	132000 29600		32012X	

⁽¹⁾Based on 1 x 10⁶ revolutions L₁₀ life, for the ISO life-calculation method.

⁽²⁾Consult your Timken engineer for instructions on use or review the Timken Engineering Manual on timken.com/catalogs.

⁽³⁾Based on 90 x 10⁶ revolutions L₁₀ life, for The Timken Company life-calculation method. C₉₀ and C_{a90} are radial and thrust values.

Bearing Dimensions											Geometry Factors			Bearing Weight
Width B	Width C	Eff. Ctr. a ⁽⁴⁾	Shaft			Housing			Cage		G ₁	G ₂	C _g	
			Max Shaft Fillet Radius R ⁽⁵⁾	Backing Shoulder Dia. d _a d _b		Max Housing Fillet Radius r ⁽⁵⁾	Backing Shoulder Dia. D _a D _b		A _a ⁽⁶⁾	A _b ⁽⁷⁾				
mm in.	mm in.	mm in.	mm in.	mm in.	mm in.	mm in.	mm in.	mm in.	mm in.	mm in.			kg lbs.	
20.000 0.7874	17.000 0.6693	-2.0 -0.08	1.5 0.06	56.0 2.20	59.0 2.32	1.5 0.06	85.0 3.35	81.0 3.19	1.3 0.05	3.1 0.13	30.3	15.9	0.0814	0.54 1.19
33.500 1.3189	27.000 1.0630	-8.1 -0.32	2.0 0.08	62.0 2.44	67.0 2.64	1.5 0.06	96.0 3.78	89.0 3.50	1.3 0.05	2.8 0.11	59.3	17.2	0.1010	1.24 2.73
27.000 1.0630	23.000 0.9055	-6.1 -0.24	2.5 0.10	58.0 2.28	62.0 2.44	2.0 0.08	103.0 4.06	98.0 3.86	1.9 0.07	3.2 0.13	48.7	16.7	0.0892	1.25 2.77
27.000 1.0630	19.000 0.7480	5.6 0.22	2.5 0.10	63.0 2.48	75.0 2.95	2.0 0.08	104.5 4.11	93.0 3.66	4.8 0.19	4.2 0.17	37.1	14.7	0.0734	1.21 2.67
40.000 1.5748	33.000 1.2992	-14.2 -0.56	2.5 0.10	60.0 2.36	65.0 2.56	2.0 0.08	103.0 4.06	95.0 3.74	4.5 0.18	2.9 0.12	60.6	16.0	0.0965	1.83 4.03
40.000 1.5748	33.000 1.2992	-8.6 -0.34	2.5 0.10	60.0 2.36	71.0 2.80	2.0 0.08	103.0 4.06	93.0 3.66	4.3 0.17	3.3 0.13	62.7	17.9	0.0783	1.94 4.27
35.000 1.3780	27.000 1.0630	-9.7 -0.38	2.0 0.08	62.0 2.44	67.0 2.64	1.5 0.06	96.0 3.78	89.0 3.50	2.8 0.11	2.8 0.11	59.3	17.2	0.1010	1.26 2.76
20.000 0.7874	17.000 0.6693	-2.0 -0.08	4.0 0.16	59.0 2.32	66.0 2.60	1.5 0.06	85.0 3.35	81.0 3.19	1.3 0.05	3.1 0.13	30.3	15.9	0.0814	0.51 1.13
23.000 0.9055	17.500 0.6890	-3.0 -0.12	1.5 0.06	62.0 2.44	65.0 2.56	1.5 0.06	86.5 3.41	82.0 3.23	1.7 0.06	2.1 0.08	46.0	28.0	0.0931	0.56 1.25
27.000 1.0630	21.000 0.8268	-7.9 -0.31	1.5 0.06	61.0 2.40	63.0 2.48	1.5 0.06	87.0 3.43	82.0 3.23	2.3 0.09	1.9 0.08	56.5	27.9	0.0915	0.66 1.46
21.000 0.8268	18.000 0.7087	-1.8 -0.07	2.0 0.08	64.0 2.52	67.0 2.64	1.5 0.06	95.0 3.74	91.0 3.58	1.5 0.06	3.6 0.14	41.9	22.8	0.0897	0.72 1.58
35.000 1.3780	27.000 1.0630	-9.7 -0.38	2.0 0.08	62.0 2.44	68.0 2.68	1.5 0.06	96.0 3.78	89.0 3.50	2.8 0.11	2.8 0.11	59.3	17.2	0.1010	1.16 2.55
29.000 1.1417	25.000 0.9843	-6.6 -0.26	2.5 0.10	70.0 2.76	71.0 2.80	2.0 0.08	113.0 4.45	108.0 4.25	2.0 0.08	2.6 0.11	62.8	24.0	0.0947	1.63 3.58
29.000 1.1417	21.000 0.8268	6.9 0.27	2.5 0.10	68.0 2.68	82.0 3.23	2.0 0.08	115.0 4.53	103.0 4.06	4.3 0.17	3.8 0.15	45.5	20.0	0.0785	1.57 3.45
43.000 1.6929	35.000 1.3780	-15.2 -0.60	2.5 0.10	66.0 2.60	70.0 2.76	2.0 0.08	112.0 4.41	105.0 4.13	5.6 0.22	3.4 0.14	77.5	18.5	0.0720	2.32 5.14
43.000 1.6929	35.000 1.3780	-8.6 -0.34	2.5 0.10	66.0 2.60	82.0 3.23	2.0 0.08	114.0 4.49	101.0 3.98	4.5 0.17	3.6 0.14	78.8	24.6	0.0844	2.45 5.40
23.000 0.9055	17.500 0.6890	-1.8 -0.07	1.5 0.06	66.0 2.60	68.0 2.68	1.5 0.06	91.0 3.58	86.0 3.39	1.8 0.07	2.1 0.08	51.2	31.4	0.0982	0.60 1.32

⁽⁴⁾Negative value indicates effective center inside cone (inner-ring) backface.

⁽⁵⁾These maximum fillet radii will be cleared by the bearing corners.

⁽⁶⁾Negative value indicates cage extends beyond cone (inner-ring) backface.

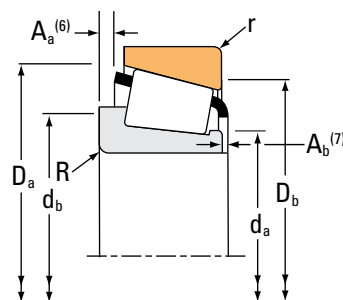
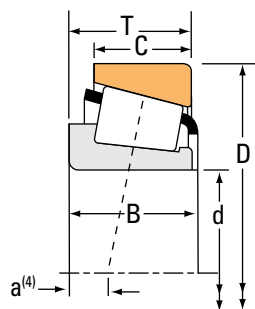
⁽⁷⁾Negative value indicates cage that does not extend beyond cone (inner-ring) front face.

Continued on next page.

TAPERED ROLLER BEARINGS

SINGLE-ROW • IsoClass

IsoClass



Bearing Dimensions			Load Ratings							Part Number		
Bore d	O.D. D	Width T	Dynamic ⁽¹⁾		Factors ⁽²⁾		Dynamic ⁽³⁾		Factors ⁽²⁾		Static C ₀	Assembly Inner/Outer
			C ₁	e	Y	C ₉₀	C _{a90}	K				
mm in.	mm in.	mm in.	N lbf			N lbf	N lbf		N lbf			
60.000 2.3622	95.000 3.7402	27.000 1.0630	103000 23100	0.33	1.83	26600 5980	14900 3360	1.78	150000 33600		33012	
60.000 2.3622	100.000 3.9370	30.000 1.1811	162000 36400	0.40	1.51	42000 9440	28600 6420	1.47	180000 40500		33112	
60.000 2.3622	110.000 4.3307	23.750 0.9350	107000 24100	0.40	1.48	27700 6240	19200 4320	1.44	117000 26200		30212	
60.000 2.3622	110.000 4.3307	38.000 1.4961	234000 52700	0.40	1.48	60700 13700	42000 9450	1.44	253000 56800		33212	
60.000 2.3622	110.000 4.3307	38.000 1.4961	234000 52700	0.40	1.48	60700 13700	42000 9450	1.44	253000 56800		XAB-33212/33212	
60.000 2.3622	110.000 4.3307	38.000 1.4961	234000 52700	0.40	1.48	60700 13700	42000 9450	1.44	253000 56800		XAA33212/33212	
60.000 2.3622	130.000 5.1181	33.500 1.3189	203000 45700	0.83	0.73	52700 11800	74400 16700	0.71	188000 42200		31312	
60.000 2.3622	130.000 5.1181	33.500 1.3189	201000 45300	0.35	1.74	52200 11700	30800 6930	1.69	221000 49800		30312	
60.000 2.3622	130.000 5.1181	48.500 1.9094	264000 59400	0.35	1.74	68500 15400	40400 9090	1.69	310000 69800		32312	
60.000 2.3622	130.000 5.1181	48.500 1.9094	264000 59400	0.55	1.10	68500 15400	64100 14400	1.07	343000 77000		32312-B	
65.000 2.5591	100.000 3.9370	23.000 0.9055	116000 26100	0.46	1.31	30100 6770	23700 5320	1.27	137000 30900		32013X	
65.000 2.5591	100.000 3.9370	27.000 1.0630	127000 28500	0.35	1.72	32900 7390	19600 4410	1.68	162000 36400		33013	
65.000 2.5591	110.000 4.3307	34.000 1.3386	167000 37500	0.39	1.55	43300 9730	28700 6460	1.51	225000 50600		33113	
65.000 2.5591	120.000 4.7244	24.750 0.9744	164000 36900	0.40	1.48	42600 9570	29500 6630	1.44	158000 35500		30213	
65.000 2.5591	120.000 4.7244	32.750 1.2894	174000 39100	0.40	1.48	45100 10100	31200 7030	1.44	209000 46900		32213	
65.000 2.5591	120.000 4.7244	41.000 1.6142	262000 58900	0.39	1.54	67900 15300	45400 10200	1.50	280000 62900		33213	
65.000 2.5591	140.000 5.5118	36.000 1.4173	222000 50000	0.35	1.74	57600 13000	34000 7650	1.69	242000 54400		30313	

⁽¹⁾Based on 1 x 10⁶ revolutions L₁₀ life, for the ISO life-calculation method.

⁽²⁾Consult your Timken engineer for instructions on use or review the Timken Engineering Manual on timken.com/catalogs.

⁽³⁾Based on 90 x 10⁶ revolutions L₁₀ life, for The Timken Company life-calculation method. C₉₀ and C_{a90} are radial and thrust values.

Bearing Dimensions											Geometry Factors			Bearing Weight
Width B	Width C	Eff. Ctr. a ⁽⁴⁾	Shaft			Housing			Cage		G ₁	G ₂	C _g	
			Max Shaft Fillet Radius R ⁽⁵⁾	Backing Shoulder Dia. d _a d _b		Max Housing Fillet Radius r ⁽⁵⁾	Backing Shoulder Dia. D _a D _b		A _a ⁽⁶⁾	A _b ⁽⁷⁾				
mm in.	mm in.	mm in.	mm in.	mm in.	mm in.	mm in.	mm in.	mm in.	mm in.	mm in.				kg lbs.
27.000 1.0630	21.000 0.8268	-7.1 -0.28	1.5 0.06	65.0 2.56	69.0 2.72	1.5 0.06	91.0 3.58	86.0 3.39	2.4 0.09	1.9 0.08	63.0	31.1	0.0964	0.69 1.53
30.000 1.1811	23.000 0.9055	-6.4 -0.25	1.5 0.06	67.0 2.64	72.0 2.83	1.5 0.06	96.0 3.78	90.0 3.54	2.4 0.09	2.5 0.10	61.7	23.9	0.1021	0.92 2.00
22.000 0.8661	19.000 0.7480	-1.8 -0.07	2.0 0.08	66.0 2.60	70.0 2.76	1.5 0.06	103.0 4.06	99.0 3.90	1.4 0.05	3.6 0.14	44.1	19.5	0.0909	0.88 1.96
38.000 1.4961	29.000 1.1417	-9.9 -0.39	2.0 0.08	68.0 2.68	74.0 2.91	1.5 0.06	105.0 4.13	98.0 3.86	3.9 0.15	2.5 0.10	76.2	20.0	0.0758	1.53 3.37
38.000 1.4961	29.000 1.1417	-9.9 -0.39	5.0 0.20	68.0 2.68	83.0 3.27	1.5 0.06	105.0 4.13	98.0 3.86	3.9 0.15	2.5 0.10	76.2	20.0	0.0758	1.53 3.37
38.000 1.4961	29.000 1.1417	-9.9 -0.39	6.0 0.24	68.0 2.68	85.0 3.35	1.5 0.06	105.0 4.13	98.0 3.86	3.9 0.15	2.5 0.10	76.2	20.0	0.0758	1.53 3.37
31.000 1.2205	22.000 0.8661	7.6 0.30	3.0 0.12	74.0 2.91	89.0 3.50	2.5 0.10	123.0 4.84	111.0 4.37	5.5 0.21	4.2 0.17	56.2	23.5	0.0842	1.97 4.35
31.000 1.2205	26.000 1.0236	-7.1 -0.28	3.0 0.12	69.0 2.72	74.0 2.91	2.5 0.10	121.0 4.76	116.0 4.57	2.5 0.10	4.0 0.16	75.8	22.2	0.0710	1.96 4.32
46.000 1.8110	37.000 1.4567	-16.5 -0.65	3.0 0.12	72.0 2.83	78.0 3.07	2.5 0.10	121.0 4.76	113.0 4.45	6.9 0.27	3.4 0.14	94.1	21.2	0.0768	2.89 6.35
46.000 1.8110	37.000 1.4567	-9.7 -0.38	3.0 0.12	72.0 2.83	90.0 3.54	2.5 0.10	122.0 4.80	110.0 4.33	5.5 0.21	4.2 0.17	95.9	23.6	0.0901	3.07 6.74
23.000 0.9055	17.500 0.6890	-0.3 -0.01	1.5 0.06	71.0 2.80	73.0 2.87	1.5 0.06	97.0 3.82	91.0 3.58	1.9 0.07	2.0 0.08	57.4	35.6	0.1039	0.64 1.40
27.000 1.0630	21.000 0.8268	-6.1 -0.24	1.5 0.06	70.0 2.76	74.0 2.91	1.5 0.06	96.0 3.78	91.0 3.58	2.5 0.10	2.0 0.08	72.4	36.1	0.1029	0.74 1.64
34.000 1.3386	26.500 1.0433	-7.9 -0.31	1.5 0.06	73.0 2.87	77.0 3.03	1.5 0.06	106.0 4.17	99.0 3.90	2.4 0.09	2.5 0.10	80.1	24.5	0.1105	1.27 2.78
23.000 0.9055	20.000 0.7874	-1.5 -0.06	2.0 0.08	74.0 2.91	77.0 3.03	1.5 0.06	113.5 4.47	110.0 4.33	2.0 0.08	4.6 0.19	60.4	27.5	0.0694	1.14 2.52
31.000 1.2205	27.000 1.0630	-5.6 -0.22	2.0 0.08	73.0 2.87	77.0 3.03	1.5 0.06	114.0 4.49	108.0 4.25	3.6 0.14	3.2 0.13	72.9	23.4	0.0742	1.51 3.33
41.000 1.6142	32.000 1.2598	-11.2 -0.44	2.0 0.08	74.0 2.91	79.0 3.11	1.5 0.06	115.0 4.53	107.0 4.21	3.4 0.13	2.8 0.11	90.3	21.8	0.0791	1.97 4.35
33.000 1.2992	28.000 1.1024	-7.6 -0.30	3.0 0.12	75.0 2.95	80.0 3.15	2.5 0.10	131.0 5.16	125.0 4.92	2.4 0.09	4.7 0.19	87.4	22.9	0.0743	2.47 5.43

⁽⁴⁾Negative value indicates effective center inside cone (inner-ring) backface.

⁽⁵⁾These maximum fillet radii will be cleared by the bearing corners.

⁽⁶⁾Negative value indicates cage extends beyond cone (inner-ring) backface.

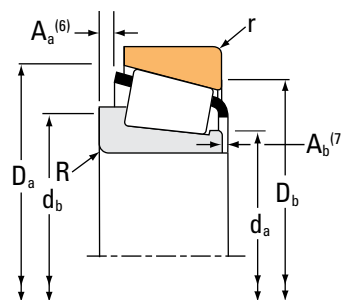
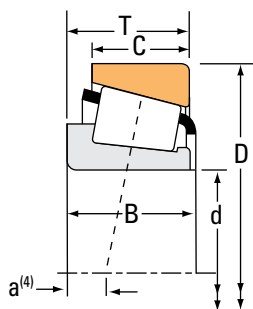
⁽⁷⁾Negative value indicates cage that does not extend beyond cone (inner-ring) front face.

Continued on next page.

TAPERED ROLLER BEARINGS

SINGLE-ROW • IsoClass

IsoClass



Bearing Dimensions			Load Ratings							Part Number		
Bore d	O.D. D	Width T	Dynamic ⁽¹⁾		Factors ⁽²⁾		Dynamic ⁽³⁾		Factors ⁽²⁾		Static C ₀	Assembly Inner/Outer
			C ₁	e	Y	C ₉₀	C _{a90}	K	C ₀			
mm in.	mm in.	mm in.	N lbf			N lbf	N lbf		N lbf			
65.000 2.5591	140.000 5.5118	36.000 1.4173	232000 52200	0.83	0.73	60300 13500	85100 19100	0.71	217000 48700		31313	
70.000 2.7559	110.000 4.3307	25.000 0.9843	133000 29900	0.43	1.38	34500 7760	25700 5780	1.34	163000 36700		32014X	
70.000 2.7559	110.000 4.3307	31.000 1.2205	153000 34500	0.28	2.11	39800 8940	19400 4360	2.05	236000 53000		33014	
70.000 2.7559	120.000 4.7244	37.000 1.4567	235000 52800	0.38	1.58	60800 13700	39400 8870	1.54	270000 60800		33114	
70.000 2.7559	125.000 4.9213	26.250 1.0335	138000 31000	0.42	1.43	35800 8050	25700 5790	1.39	157000 35300		30214	
70.000 2.7559	125.000 4.9213	33.250 1.3091	216000 48600	0.42	1.43	56000 12600	40300 9060	1.39	224000 50400		32214	
70.000 2.7559	150.000 5.9055	38.000 1.4961	251000 56500	0.35	1.74	65100 14600	38500 8650	1.69	276000 62000		30314	
70.000 2.7559	150.000 5.9055	54.000 2.1260	434000 97500	0.35	1.74	112000 25300	66400 14900	1.69	448000 101000		32314	
70.000 2.7559	150.000 5.9055	38.000 1.4961	252000 56800	0.83	0.73	65500 14700	92500 20800	0.71	235000 52900		31314	
75.000 2.9528	115.000 4.5276	25.000 0.9842	135000 30400	0.46	1.31	35000 7870	27500 6180	1.27	170000 38200		32015X	
75.000 2.9528	115.000 4.5276	31.000 1.2205	187000 42000	0.30	2.01	48400 10900	24700 5560	1.96	239000 53700		33015	
75.000 2.9528	125.000 4.9213	37.000 1.4567	205000 46000	0.40	1.51	53000 11900	36100 8110	1.47	287000 64500		33115	
75.000 2.9528	130.000 5.1181	27.250 1.0728	181000 40600	0.44	1.38	46800 10500	34900 7840	1.34	180000 40400		30215	
75.000 2.9528	130.000 5.1181	33.250 1.3091	218000 49000	0.44	1.38	56500 12700	42100 9460	1.34	227000 51100		32215	
75.000 2.9528	130.000 5.1181	41.000 1.6142	236000 53100	0.43	1.40	61200 13800	44900 10100	1.37	316000 71000		33215	
75.000 2.9528	160.000 6.2992	40.000 1.5748	354000 79600	0.35	1.74	91800 20600	54200 12200	1.69	338000 76000		30315	
75.000 2.9528	160.000 6.2992	40.000 1.5748	248000 55800	0.83	0.73	64400 14500	90900 20400	0.71	278000 62500		31315	

⁽¹⁾Based on 1 x 10⁶ revolutions L₁₀ life, for the ISO life-calculation method.

⁽²⁾Consult your Timken engineer for instructions on use or review the Timken Engineering Manual on timken.com/catalogs.

⁽³⁾Based on 90 x 10⁶ revolutions L₁₀ life, for The Timken Company life-calculation method. C₉₀ and C_{a90} are radial and thrust values.

Bearing Dimensions											Geometry Factors			Bearing Weight
Width B	Width C	Eff. Ctr. a ⁽⁴⁾	Shaft			Housing			Cage		G ₁	G ₂	C _g	
			Max Shaft Fillet Radius R ⁽⁵⁾	Backing Shoulder Dia. d _a d _b		Max Housing Fillet Radius r ⁽⁵⁾	Backing Shoulder Dia. D _a D _b		A _a ⁽⁶⁾	A _b ⁽⁷⁾				
mm in.	mm in.	mm in.	mm in.	mm in.	mm in.	mm in.	mm in.	mm in.	mm in.	mm in.			kg lbs.	
33.000 1.2992	23.000 0.9055	8.1 0.32	3.0 0.12	80.0 3.15	96.0 3.78	2.5 0.10	132.5 5.22	120.0 4.72	5.7 0.22	5.0 0.20	67.1	22.2	0.0839	2.39 5.27
25.000 0.9843	19.000 0.7480	-1.0 -0.04	1.5 0.06	76.0 2.99	78.0 3.07	1.5 0.06	105.0 4.13	100.0 3.94	2.3 0.09	1.9 0.08	74.1	44.8	0.1112	0.86 1.91
31.000 1.2205	25.500 1.0039	-8.6 -0.34	1.5 0.06	77.0 3.03	79.0 3.11	1.5 0.06	106.0 4.17	101.0 3.98	0.5 0.02	3.6 0.15	105.3	50.1	0.1092	1.11 2.43
37.000 1.4567	29.000 1.1417	-8.6 -0.34	2.0 0.08	79.0 3.11	85.0 3.35	1.5 0.06	115.0 4.53	108.0 4.25	2.7 0.10	2.4 0.10	99.5	31.6	0.0809	1.69 3.70
24.000 0.9449	21.000 0.8268	-0.5 -0.02	2.0 0.08	77.0 3.03	80.0 3.15	1.5 0.06	118.0 4.65	115.0 4.53	1.8 0.07	3.9 0.15	63.7	24.8	0.0714	1.23 2.73
31.000 1.2205	27.000 1.0630	-4.6 -0.18	2.0 0.08	79.0 3.11	82.0 3.23	1.5 0.06	119.0 4.69	114.0 4.49	3.4 0.13	3.3 0.13	81.4	25.6	0.0779	1.63 3.59
35.000 1.3780	30.000 1.1811	-8.1 -0.32	3.0 0.12	83.0 3.27	88.0 3.46	2.5 0.10	139.5 5.49	135.0 5.31	3.1 0.12	4.9 0.20	102.4	27.4	0.0737	2.97 6.53
51.000 2.0079	42.000 1.6535	-16.8 -0.66	3.0 0.12	86.0 3.39	94.0 3.70	2.5 0.10	141.0 5.55	133.0 5.24	4.0 0.15	4.9 0.20	141.9	33.1	0.0828	4.39 9.69
35.000 1.3780	25.000 0.9843	9.1 0.36	3.0 0.12	85.0 3.35	101.0 3.98	2.5 0.10	141.5 5.57	129.0 5.08	5.9 0.23	4.8 0.19	75.8	29.5	0.0873	2.92 6.46
25.000 0.9843	19.000 0.7480	0.5 0.02	1.5 0.06	82.0 3.23	84.0 3.31	1.5 0.06	110.0 4.33	105.0 4.13	2.4 0.09	1.9 0.08	81.8	49.9	0.1166	0.91 2.01
31.000 1.2205	25.500 1.0039	-7.6 -0.30	1.5 0.06	83.0 3.27	90.0 3.54	1.5 0.06	110.0 4.33	104.0 4.09	1.5 0.05	2.5 0.10	109.4	47.2	0.1122	1.15 2.54
37.000 1.4567	29.000 1.1417	-7.4 -0.29	2.0 0.08	83.0 3.27	88.0 3.46	1.5 0.06	120.0 4.72	112.0 4.41	2.8 0.11	2.4 0.10	110.7	26.3	0.0851	1.76 3.87
25.000 0.9843	22.000 0.8661	0.0 0.00	2.0 0.08	85.0 3.35	88.0 3.46	1.5 0.06	124.0 4.88	120.0 4.72	2.0 0.08	3.8 0.15	74.3	23.5	0.0761	1.35 2.97
31.000 1.2205	27.000 1.0630	-3.6 -0.14	2.0 0.08	84.0 3.31	88.0 3.46	1.5 0.06	125.0 4.92	117.0 4.61	3.5 0.13	3.4 0.14	87.5	26.9	0.0806	1.69 3.72
41.000 1.6142	31.000 1.2205	-8.6 -0.34	2.0 0.08	83.0 3.27	89.0 3.50	1.5 0.06	125.0 4.92	117.0 4.61	4.2 0.16	2.8 0.11	111.4	27.0	0.0874	2.17 4.77
37.000 1.4567	31.000 1.2205	-8.1 -0.32	3.0 0.12	89.0 3.50	94.0 3.70	2.5 0.10	149.0 5.87	145.0 5.71	2.7 0.10	5.7 0.23	126.6	26.7	0.0841	3.65 8.05
37.000 1.4567	26.000 1.0236	10.2 0.40	3.0 0.12	91.0 3.58	108.0 4.25	2.5 0.10	151.5 5.96	138.0 5.43	6.9 0.27	5.0 0.20	91.5	21.4	0.0930	3.46 7.63

⁽⁴⁾Negative value indicates effective center inside cone (inner-ring) backface.

⁽⁵⁾These maximum fillet radii will be cleared by the bearing corners.

⁽⁶⁾Negative value indicates cage extends beyond cone (inner-ring) backface.

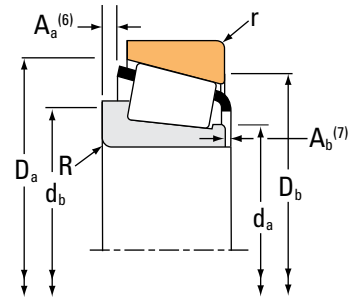
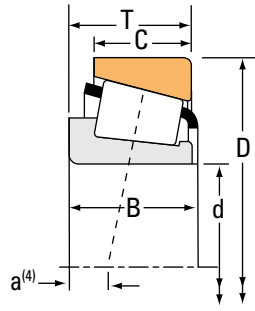
⁽⁷⁾Negative value indicates cage that does not extend beyond cone (inner-ring) front face.

Continued on next page.

TAPERED ROLLER BEARINGS

SINGLE-ROW • IsoClass

IsoClass



Bearing Dimensions			Load Ratings							Part Number		
Bore d	O.D. D	Width T	Dynamic ⁽¹⁾		Factors ⁽²⁾		Dynamic ⁽³⁾		Factors ⁽²⁾		Static C ₀	Assembly Inner/Outer
			C ₁	e	Y	C ₉₀	C _{a90}	K	C ₀			
mm in.	mm in.	mm in.	N lbf			N lbf	N lbf			N lbf		
80.000 3.1496	125.000 4.9213	29.000 1.1417	197000 44200	0.42	1.42	51000 11500	36900 8300	1.38		238000 53600	32016X	
80.000 3.1496	130.000 5.1181	37.000 1.4567	193000 43400	0.42	1.44	50100 11300	35700 8020	1.40		300000 67300	33116	
80.000 3.1496	130.000 5.1181	37.000 1.4567	247000 55600	0.42	1.44	64100 14400	45700 10300	1.40		300000 67300	XA33116/Y33116	
80.000 3.1496	140.000 5.5118	28.250 1.1122	164000 36800	0.42	1.43	42400 9530	30500 6860	1.39		187000 42000	30216	
80.000 3.1496	140.000 5.5118	35.250 1.3878	244000 54800	0.42	1.43	63200 14200	45400 10200	1.39		249000 56000	32216	
80.000 3.1496	140.000 5.5118	46.000 1.8110	297000 66700	0.43	1.41	76900 17300	56000 12600	1.37		409000 91900	33216	
80.000 3.1496	141.000 5.5512	30.250 1.1909	164000 36800	0.42	1.43	42400 9530	30500 6860	1.39		187000 42000	XUB-30216/YFA30216	
80.000 3.1496	170.000 6.6929	42.500 1.6732	334000 75200	0.35	1.74	86700 19500	51200 11500	1.69		381000 85600	30316	
80.000 3.1496	170.000 6.6929	61.500 2.4213	448000 101000	0.35	1.74	116000 26100	68700 15400	1.69		566000 127000	32316	
84.000 3.3071	140.000 5.5118	32.000 1.2598	217000 48800	0.42	1.42	56300 12700	40800 9170	1.38		264000 59400	XUA32018X/32018X	
85.000 3.3465	130.000 5.1181	29.000 1.1417	193000 43300	0.44	1.36	49900 11200	37800 8500	1.32		235000 52900	32017X	
85.000 3.3465	130.000 5.1181	29.000 1.1417	193000 43300	0.44	1.36	49900 11200	37800 8500	1.32		235000 52900	XAA32017X/32017X	
85.000 3.3465	130.000 5.1181	36.000 1.4173	220000 49500	0.29	2.06	57100 12800	28500 6410	2.00		343000 77100	33017	
85.000 3.3465	140.000 5.5118	41.000 1.6142	254000 57100	0.41	1.48	65800 14800	45800 10300	1.44		386000 86800	33117	
85.000 3.3465	150.000 5.9055	30.500 1.2008	236000 53100	0.42	1.43	61200 13800	44000 9900	1.39		236000 53000	30217	
85.000 3.3465	150.000 5.9055	38.500 1.5157	245000 55100	0.42	1.43	63600 14300	45700 10300	1.39		305000 68700	32217	
85.000 3.3465	150.000 5.9055	49.000 1.9291	416000 93600	0.42	1.43	108000 24300	77300 17400	1.40		483000 109000	33217	

⁽¹⁾Based on 1 x 10⁶ revolutions L₁₀ life, for the ISO life-calculation method.

⁽²⁾Consult your Timken engineer for instructions on use or review the Timken Engineering Manual on timken.com/catalogs.

⁽³⁾Based on 90 x 10⁶ revolutions L₁₀ life, for The Timken Company life-calculation method. C₉₀ and C_{a90} are radial and thrust values.

Bearing Dimensions											Geometry Factors			Bearing Weight
Width B	Width C	Eff. Ctr. a ⁽⁴⁾	Shaft			Housing			Cage		G ₁	G ₂	C _g	
			Max Shaft Fillet Radius R ⁽⁵⁾	Backing Shoulder Dia. d _a d _b		Max Housing Fillet Radius r ⁽⁵⁾	Backing Shoulder Dia. D _a D _b		A _a ⁽⁶⁾	A _b ⁽⁷⁾				
mm in.	mm in.	mm in.	mm in.	mm in.	mm in.	mm in.	mm in.	mm in.	mm in.	mm in.			kg lbs.	
29.000 1.1417	22.000 0.8661	-1.8 -0.07	1.5 0.06	87.0 3.43	91.0 3.58	1.5 0.06	120.0 4.72	114.0 4.49	2.8 0.11	2.4 0.10	104.0	36.3	0.1234	1.27 2.80
37.000 1.4567	29.000 1.1417	-6.1 -0.24	2.0 0.08	89.0 3.50	94.0 3.70	1.5 0.06	125.0 4.92	119.0 4.69	3.4 0.13	2.5 0.10	121.6	37.9	0.0891	1.86 4.10
37.000 1.4567	29.000 1.1417	-6.1 -0.24	2.0 0.08	89.0 3.50	94.0 3.70	1.5 0.06	125.0 4.92	119.0 4.69	3.4 0.13	2.5 0.10	121.6	37.9	0.0838	1.85 4.10
26.000 1.0236	22.000 0.8661	0.0 0.00	2.5 0.10	89.0 3.50	93.0 3.66	2.0 0.08	133.0 5.24	127.0 5.00	1.8 0.07	3.6 0.14	80.7	28.4	0.0771	1.63 3.58
33.000 1.2992	28.000 1.1024	-4.6 -0.18	2.5 0.10	91.0 3.58	96.0 3.78	2.0 0.08	134.0 5.28	128.0 5.04	3.8 0.15	4.1 0.16	98.4	28.7	0.0828	2.07 4.55
46.000 1.8110	35.000 1.3780	-10.7 -0.42	2.5 0.10	89.0 3.50	97.0 3.82	2.0 0.08	135.0 5.31	125.0 4.92	5.3 0.21	2.9 0.12	142.7	38.0	0.0948	2.95 6.49
28.000 1.1024	22.000 0.8661	-2.0 -0.08	0.5 0.02	90.0 3.54	90.0 3.54	2.0 0.08	133.0 5.24	128.0 5.04	3.8 0.15	3.6 0.14	80.7	28.4	0.0771	1.80 3.98
39.000 1.5354	33.000 1.2992	-8.1 -0.32	3.0 0.12	96.0 3.78	100.0 3.94	2.5 0.10	159.0 6.26	154.0 6.06	3.2 0.12	4.5 0.18	147.1	37.6	0.0831	4.31 9.50
58.000 2.2835	48.000 1.8898	-19.0 -0.75	3.0 0.12	100.0 3.94	105.0 4.13	2.5 0.10	159.0 6.26	152.0 5.98	6.9 0.27	4.0 0.16	196.5	27.7	0.0923	6.34 13.99
32.000 1.2598	24.000 0.9449	-2.0 -0.08	0.5 0.02	94.0 3.70	94.0 3.70	1.5 0.06	134.0 5.28	128.0 5.04	3.2 0.12	2.2 0.09	127.5	41.1	0.1317	1.96 4.31
29.000 1.1417	22.000 0.8661	-0.5 -0.02	1.5 0.06	92.0 3.62	95.0 3.74	1.5 0.06	125.0 4.92	119.0 4.69	2.1 0.08	2.8 0.11	109.2	34.9	0.1270	1.33 2.93
29.000 1.1417	22.000 0.8661	-0.5 -0.02	6.5 0.26	92.0 3.62	106.0 4.17	1.5 0.06	125.0 4.92	119.0 4.69	2.1 0.08	2.8 0.11	109.2	34.9	0.1270	1.31 2.89
36.000 1.4173	29.500 1.1614	-9.4 -0.37	1.5 0.06	93.0 3.66	96.0 3.78	1.5 0.06	125.0 4.92	120.0 4.72	1.5 0.05	2.8 0.11	157.9	55.6	0.0865	1.73 3.83
41.000 1.6142	32.000 1.2598	-8.1 -0.32	2.5 0.10	96.0 3.78	102.0 4.02	2.0 0.08	135.0 5.31	126.0 4.96	4.4 0.17	2.8 0.11	160.9	39.6	0.0972	2.45 5.42
28.000 1.1024	24.000 0.9449	-0.3 -0.01	2.5 0.10	93.0 3.66	97.0 3.82	2.0 0.08	142.0 5.59	137.0 5.39	2.0 0.08	4.2 0.17	101.2	24.9	0.0833	2.07 4.57
36.000 1.4173	30.000 1.1811	-4.6 -0.18	2.5 0.10	94.0 3.70	100.0 3.94	2.0 0.08	142.0 5.59	134.0 5.28	4.0 0.16	3.2 0.13	121.4	32.6	0.0888	2.62 5.78
49.000 1.9291	37.000 1.4567	-11.7 -0.46	2.5 0.10	94.0 3.70	103.0 4.06	2.0 0.08	144.0 5.67	134.0 5.28	5.6 0.22	3.3 0.13	167.6	33.3	0.0995	3.60 7.92

⁽⁴⁾Negative value indicates effective center inside cone (inner-ring) backface.

⁽⁵⁾These maximum fillet radii will be cleared by the bearing corners.

⁽⁶⁾Negative value indicates cage extends beyond cone (inner-ring) backface.

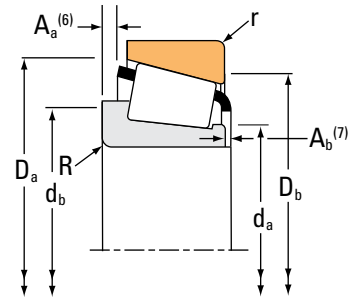
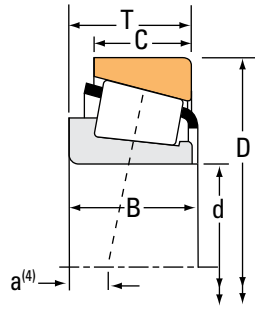
⁽⁷⁾Negative value indicates cage that does not extend beyond cone (inner-ring) front face.

Continued on next page.

TAPERED ROLLER BEARINGS

SINGLE-ROW • IsoClass

IsoClass



Bearing Dimensions			Load Ratings							Part Number		
Bore d	O.D. D	Width T	Dynamic ⁽¹⁾		Factors ⁽²⁾		Dynamic ⁽³⁾		Factors ⁽²⁾		Static C ₀	Assembly Inner/Outer
			C ₁	e	Y	C ₉₀	C _{a90}	K	C ₀			
mm in.	mm in.	mm in.	N lbf			N lbf	N lbf		N lbf			
85.000 3.3465	180.000 7.0866	44.500 1.7520	313000 70500	0.35	1.74	81300 18300	48000 10800	1.69	346000 77700			30317
90.000 3.5433	140.000 5.5118	32.000 1.2598	217000 48800	0.42	1.42	56300 12700	40800 9170	1.38	264000 59400			32018X
90.000 3.5433	140.000 5.5118	32.000 1.2598	217000 48800	0.42	1.42	56300 12700	40800 9170	1.38	264000 59400			XAA32018X/32018X
90.000 3.5433	140.000 5.5118	39.000 1.5354	293000 65900	0.27	2.23	76000 17100	35000 7860	2.17	377000 84700			33018
90.000 3.5433	150.000 5.9055	45.000 1.7717	363000 81600	0.40	1.51	94100 21200	64000 14400	1.47	447000 100000			33118
90.000 3.5433	160.000 6.2992	32.500 1.2795	240000 54100	0.42	1.43	62300 14000	44800 10100	1.39	295000 66200			30218
95.000 3.7402	145.000 5.7087	39.000 1.5354	246000 55300	0.28	2.16	63800 14300	30400 6830	2.10	378000 85100			XAA33019/33019
95.000 3.7402	170.000 6.6929	34.500 1.3583	235000 52800	0.42	1.43	60900 13700	43800 9850	1.39	276000 62100			30219
95.000 3.7402	170.000 6.6929	45.500 1.7913	316000 71100	0.42	1.43	82000 18400	59000 13300	1.39	401000 90100			32219
100.000 3.9370	150.000 5.9055	32.000 1.2598	231000 51800	0.46	1.31	59800 13400	46900 10600	1.27	295000 66400			32020X
100.000 3.9370	150.000 5.9055	39.000 1.5354	251000 56300	0.29	2.09	65000 14600	31900 7180	2.03	393000 88300			33020
100.000 3.9370	180.000 7.0866	37.000 1.4567	301000 67600	0.42	1.43	78000 17500	56100 12600	1.39	375000 84300			30220
100.000 3.9370	180.000 7.0866	49.000 1.9291	368000 82700	0.42	1.43	95300 21400	68600 15400	1.39	478000 107000			32220
105.000 4.1339	160.000 6.2992	35.000 1.3780	269000 60500	0.44	1.35	69800 15700	53100 11900	1.31	339000 76200			32021X
105.000 4.1339	160.000 6.2992	43.000 1.6929	291000 65400	0.28	2.12	75400 17000	36500 8200	2.07	449000 101000			33021
105.000 4.1339	190.000 7.4803	39.000 1.5354	325000 73200	0.42	1.43	84400 19000	60700 13600	1.39	407000 91400			30221
105.000 4.1339	190.000 7.4803	53.000 2.0866	398000 89600	0.42	1.43	103000 23200	74300 16700	1.39	516000 116000			32221

⁽¹⁾Based on 1 x 10⁶ revolutions L₁₀ life, for the ISO life-calculation method.

⁽²⁾Consult your Timken engineer for instructions on use or review the Timken Engineering Manual on timken.com/catalogs.

⁽³⁾Based on 90 x 10⁶ revolutions L₁₀ life, for The Timken Company life-calculation method. C₉₀ and C_{a90} are radial and thrust values.

Bearing Dimensions											Geometry Factors			Bearing Weight
Width B	Width C	Eff. Ctr. a ⁽⁴⁾	Shaft			Housing			Cage		G ₁	G ₂	C _g	
			Max Shaft Fillet Radius R ⁽⁵⁾	Backing Shoulder Dia. d _a d _b		Max Housing Fillet Radius r ⁽⁵⁾	Backing Shoulder Dia. D _a D _b		A _a ⁽⁶⁾	A _b ⁽⁷⁾				
mm in.	mm in.	mm in.	mm in.	mm in.	mm in.	mm in.	mm in.	mm in.	mm in.	mm in.			kg lbs.	
41.000 1.6142	34.000 1.3386	-9.7 -0.38	4.0 0.16	100.0 3.94	106.0 4.17	3.0 0.12	166.5 6.56	162.0 6.38	6.0 0.23	3.6 0.14	143.9	41.7	0.0823	4.78 10.54
32.000 1.2598	24.000 0.9449	-2.0 -0.08	2.0 0.08	98.0 3.86	102.0 4.02	1.5 0.06	134.0 5.28	128.0 5.04	3.2 0.12	2.2 0.09	127.5	41.1	0.1317	1.70 3.75
32.000 1.2598	24.000 0.9449	-2.0 -0.08	6.0 0.24	98.0 3.86	111.0 4.37	1.5 0.06	134.0 5.28	128.0 5.04	3.2 0.12	2.2 0.09	127.5	41.1	0.1317	1.70 3.75
39.000 1.5354	32.500 1.2795	-10.9 -0.43	2.0 0.08	98.0 3.86	101.0 3.98	1.5 0.06	135.0 5.31	131.0 5.16	1.8 0.07	2.4 0.10	183.4	56.0	0.0884	2.20 4.85
45.000 1.7717	35.000 1.3780	-9.4 -0.37	2.5 0.10	100.0 3.94	108.0 4.25	2.0 0.08	145.0 5.71	135.0 5.31	3.8 0.15	3.0 0.12	180.1	43.2	0.1001	3.15 6.93
30.000 1.1811	26.000 1.0236	-0.5 -0.02	2.5 0.10	102.0 4.02	106.0 4.17	2.0 0.08	152.0 5.98	146.0 5.75	3.9 0.15	4.6 0.18	125.9	47.7	0.0844	2.63 5.79
39.000 1.5354	32.500 1.2795	-10.2 -0.40	6.0 0.24	102.0 4.02	114.0 4.49	1.5 0.06	139.0 5.47	133.0 5.24	1.8 0.07	2.3 0.09	192.5	48.4	0.0907	2.23 4.93
32.000 1.2598	27.000 1.0630	-0.8 -0.03	3.0 0.12	104.0 4.09	109.0 4.29	2.5 0.10	159.0 6.26	155.0 6.10	3.1 0.12	4.5 0.18	127.7	36.9	0.0898	3.02 6.65
43.000 1.6929	37.000 1.4567	-6.3 -0.25	3.0 0.12	106.0 4.17	111.0 4.37	2.5 0.10	161.0 6.34	152.0 5.98	4.7 0.18	3.0 0.12	165.5	35.3	0.0984	4.06 8.94
32.000 1.2598	24.000 0.9449	0.8 0.03	2.0 0.08	108.0 4.25	112.0 4.41	1.5 0.06	145.0 5.71	137.0 5.39	3.5 0.13	2.3 0.09	153.8	50.3	0.1296	1.89 4.17
39.000 1.5354	32.500 1.2795	-9.4 -0.37	2.0 0.08	107.0 4.21	111.0 4.37	1.5 0.06	144.0 5.67	139.0 5.47	1.9 0.07	2.4 0.10	206.3	65.1	0.0938	2.36 5.22
34.000 1.3386	29.000 1.1417	-0.8 -0.03	3.0 0.12	115.0 4.53	119.0 4.69	2.5 0.10	169.0 6.65	163.0 6.42	2.1 0.08	4.7 0.19	167.4	51.9	0.0927	3.76 8.30
46.000 1.8110	39.000 1.5354	-7.1 -0.28	3.0 0.12	112.0 4.41	117.0 4.61	2.5 0.10	170.0 6.69	163.0 6.42	5.8 0.22	3.3 0.13	198.1	39.4	0.1046	4.92 10.84
35.000 1.3780	26.000 1.0236	-0.3 -0.01	2.5 0.10	113.0 4.45	119.0 4.69	2.0 0.08	154.0 6.06	146.0 5.79	3.2 0.12	2.7 0.11	176.5	50.7	0.1024	2.40 5.28
43.000 1.6929	34.000 1.3386	-12.2 -0.48	2.5 0.10	113.0 4.45	118.0 4.65	2.0 0.08	153.0 6.02	147.0 5.79	3.1 0.12	3.1 0.13	236.3	54.8	0.0975	2.94 6.50
36.000 1.4173	30.000 1.1811	-1.3 -0.05	3.0 0.12	120.0 4.72	124.0 4.88	2.5 0.10	179.0 7.05	172.0 6.77	4.5 0.18	1.1 0.05	186.7	59.4	0.0960	4.47 9.86
50.000 1.9685	43.000 1.6929	-7.9 -0.31	3.0 0.12	120.0 4.72	127.0 5.00	2.5 0.10	180.0 7.09	171.0 6.73	5.1 0.20	2.7 0.11	219.9	43.5	0.1082	5.94 13.09

⁽⁴⁾Negative value indicates effective center inside cone (inner-ring) backface.

⁽⁵⁾These maximum fillet radii will be cleared by the bearing corners.

⁽⁶⁾Negative value indicates cage extends beyond cone (inner-ring) backface.

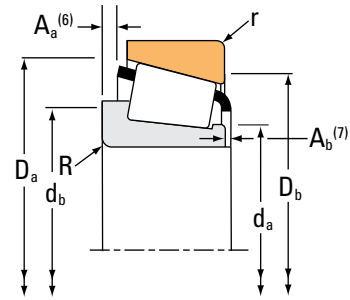
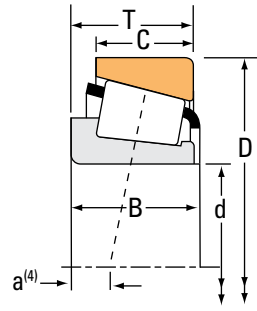
⁽⁷⁾Negative value indicates cage that does not extend beyond cone (inner-ring) front face.

Continued on next page.

TAPERED ROLLER BEARINGS

SINGLE-ROW • IsoClass

IsoClass



Bearing Dimensions			Load Ratings							Part Number		
Bore d	O.D. D	Width T	Dynamic ⁽¹⁾		Factors ⁽²⁾		Dynamic ⁽³⁾		Factors ⁽²⁾		Static C ₀	Assembly Inner/Outer
			C ₁	e	Y	C ₉₀	C _{a90}	K	C ₀			
mm in.	mm in.	mm in.	N lbf			N lbf	N lbf			N lbf		
106.000 4.1732	160.000 6.2992	35.000 1.3780	269000 60500	0.44	1.35	69800 15700	53100 11900	1.31		339000 76200	XGA32021X/32021X	
110.000 4.3307	170.000 6.6929	38.000 1.4961	334000 75000	0.43	1.39	86500 19400	63700 14300	1.36		433000 97300	32022X	
110.000 4.3307	200.000 7.8740	41.000 1.6142	374000 84000	0.42	1.43	96900 21800	69700 15700	1.39		475000 107000	30222	
110.000 4.3307	200.000 7.8740	56.000 2.2047	493000 111000	0.42	1.43	128000 28700	91900 20700	1.39		668000 150000	32222	
120.000 4.7244	165.000 6.4961	29.000 1.1417	172000 38800	0.35	1.72	44700 10100	26700 6000	1.68		317000 71200	32924	
120.000 4.7244	180.000 7.0866	38.000 1.4961	292000 65700	0.46	1.31	75800 17000	59500 13400	1.27		466000 105000	32024X	
120.000 4.7244	180.000 7.0866	38.000 1.4961	347000 77900	0.46	1.31	89800 20200	70500 15900	1.27		466000 105000	XAA32024X/32024X	
120.000 4.7244	180.000 7.0866	38.000 1.4961	347000 77900	0.46	1.31	89800 20200	70500 15900	1.27		466000 105000	32024X	
120.000 4.7244	215.000 8.4646	43.500 1.7126	396000 89100	0.44	1.38	103000 23100	76500 17200	1.34		508000 114000	30224	
130.000 5.1181	200.000 7.8740	45.000 1.7717	386000 86900	0.43	1.38	100000 22500	74600 16800	1.34		617000 139000	32026X	
130.000 5.1181	230.000 9.0551	43.750 1.7224	431000 96900	0.44	1.38	112000 25100	83200 18700	1.34		550000 124000	30226	
140.000 5.5118	190.000 7.4803	32.000 1.2598	224000 50300	0.36	1.67	58000 13000	35800 8040	1.62		398000 89500	32928	
140.000 5.5118	210.000 8.2677	45.000 1.7717	393000 88400	0.46	1.31	102000 22900	80000 18000	1.27		644000 145000	XAA32028X/Y32028X	
140.000 5.5118	250.000 9.8425	45.750 1.8012	502000 113000	0.44	1.38	130000 29200	96900 21800	1.34		649000 146000	30228	
150.000 5.9055	210.000 8.2677	38.000 1.4961	324000 72800	0.33	1.83	84000 18900	47200 10600	1.78		573000 129000	32930	
150.000 5.9055	225.000 8.8583	48.000 1.8898	443000 99500	0.46	1.31	115000 25800	90100 20300	1.27		730000 164000	32030X	
150.000 5.9055	270.000 10.6299	49.000 1.9291	565000 127000	0.44	1.38	146000 32900	109000 24500	1.34		735000 165000	30230	

⁽¹⁾Based on 1 x 10⁶ revolutions L₁₀ life, for the ISO life-calculation method.

⁽²⁾Consult your Timken engineer for instructions on use or review the Timken Engineering Manual on timken.com/catalogs.

⁽³⁾Based on 90 x 10⁶ revolutions L₁₀ life, for The Timken Company life-calculation method. C₉₀ and C_{a90} are radial and thrust values.

Bearing Dimensions											Geometry Factors			Bearing Weight
Width B	Width C	Eff. Ctr. a ⁽⁴⁾	Shaft			Housing			Cage		G ₁	G ₂	C _g	
			Max Shaft Fillet Radius R ⁽⁵⁾	Backing Shoulder Dia. d _a d _b		Max Housing Fillet Radius r ⁽⁵⁾	Backing Shoulder Dia. D _a D _b		A _a ⁽⁶⁾	A _b ⁽⁷⁾				
mm in.	mm in.	mm in.	mm in.	mm in.	mm in.	mm in.	mm in.	mm in.	mm in.	mm in.			kg lbs.	
35.000 1.3780	26.000 1.0236	-0.3 -0.01	6.0 0.24	115.0 4.53	128.0 5.04	2.0 0.08	154.0 6.06	146.0 5.79	3.2 0.12	2.7 0.11	176.5	50.7	0.1024	2.33 5.15
38.000 1.4961	29.000 1.1417	-1.0 -0.04	2.5 0.10	119.0 4.69	124.0 4.88	2.0 0.08	164.0 6.46	156.0 6.14	3.2 0.12	3.0 0.12	222.1	49.3	0.1095	3.06 6.74
38.000 1.4961	32.000 1.2598	-1.5 -0.06	3.0 0.12	126.0 4.96	130.0 5.12	2.5 0.10	187.0 7.36	181.0 7.13	4.1 0.16	5.7 0.23	219.5	59.8	0.1014	5.24 11.54
53.000 2.0866	46.000 1.8110	-10.1 -0.40	3.0 0.12	125.0 4.92	135.0 5.31	2.5 0.10	190.5 7.50	179.0 7.05	3.8 0.15	5.2 0.21	277.3	55.7	0.1102	7.28 16.06
29.000 1.1417	23.000 0.9055	0.3 0.01	1.5 0.06	128.0 5.04	130.0 5.12	1.5 0.06	160.0 6.30	155.0 6.10	2.1 0.08	2.5 0.10	226.8	103.0	0.1488	1.78 3.92
38.000 1.4961	29.000 1.1417	1.5 0.06	2.5 0.10	130.0 5.12	134.0 5.28	2.0 0.08	174.0 6.85	165.0 6.50	3.4 0.13	3.0 0.12	255.1	58.3	0.1169	3.27 7.22
38.000 1.4961	29.000 1.1417	1.5 0.06	5.0 0.20	130.0 5.12	141.0 5.55	2.0 0.08	174.0 6.85	165.0 6.50	3.4 0.13	3.0 0.12	255.1	58.3	0.1169	3.25 7.19
38.000 1.4961	29.000 1.1417	1.5 0.06	2.5 0.10	130.0 5.12	136.0 5.35	2.0 0.08	174.0 6.85	165.0 6.50	3.4 0.13	3.0 0.12	255.1	58.3	0.1100	3.26 7.21
40.000 1.5748	34.000 1.3386	0.3 0.01	3.0 0.12	136.0 5.35	140.0 5.51	2.5 0.10	201.0 7.91	195.0 7.68	3.7 0.14	6.3 0.25	252.0	64.9	0.1072	6.24 13.75
45.000 1.7717	34.000 1.3386	-1.0 -0.04	2.5 0.10	142.0 5.59	148.0 5.83	2.0 0.08	193.0 7.60	184.0 7.24	3.9 0.15	2.0 0.08	338.4	97.3	0.1189	4.98 10.98
40.000 1.5748	34.000 1.3386	2.0 0.08	4.0 0.16	146.0 5.75	152.0 5.98	3.0 0.12	217.0 8.54	210.0 8.27	2.8 0.11	7.1 0.28	287.4	77.1	0.1118	7.06 15.56
32.000 1.2598	25.000 0.9843	2.3 0.09	2.0 0.08	148.0 5.83	151.0 5.94	1.5 0.06	184.0 7.24	179.0 7.05	1.5 0.06	2.7 0.11	314.5	144.7	0.1509	2.50 5.53
45.000 1.7717	34.000 1.3386	1.4 0.06	6.5 0.26	151.0 5.94	158.0 6.22	2.0 0.08	203.0 7.99	193.0 7.60	3.9 0.15	2.0 0.08	374.2	108.2	0.1249	5.23 11.54
42.000 1.6535	36.000 1.4173	2.8 0.11	4.0 0.16	157.0 6.18	164.0 6.46	3.0 0.12	234.0 9.21	227.0 8.94	4.3 0.17	7.4 0.29	347.8	75.8	0.1191	8.92 19.65
38.000 1.4961	30.000 1.1811	-1.5 -0.06	2.5 0.10	160.0 6.30	163.0 6.42	2.0 0.08	203.0 7.99	197.0 7.76	1.5 0.06	3.9 0.16	428.9	157.2	0.1167	3.99 8.82
48.000 1.8898	36.000 1.4173	1.0 0.04	3.0 0.12	163.0 6.42	169.0 6.65	2.5 0.10	217.0 8.54	206.0 8.11	2.9 0.11	4.0 0.16	437.0	114.5	0.1314	6.38 14.08
45.000 1.7717	38.000 1.4961	3.6 0.14	4.0 0.16	168.0 6.61	174.0 6.85	3.0 0.12	250.0 9.84	245.0 9.65	2.9 0.11	7.5 0.30	407.0	78.5	0.1254	11.03 24.29

⁽⁴⁾Negative value indicates effective center inside cone (inner-ring) backface.

⁽⁵⁾These maximum fillet radii will be cleared by the bearing corners.

⁽⁶⁾Negative value indicates cage extends beyond cone (inner-ring) backface.

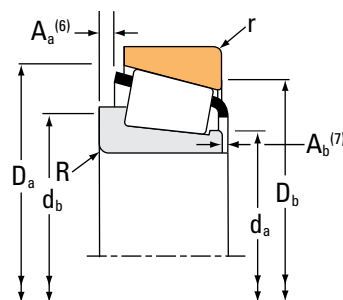
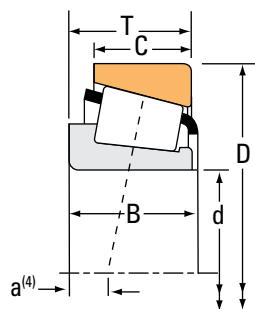
⁽⁷⁾Negative value indicates cage that does not extend beyond cone (inner-ring) front face.

Continued on next page.

TAPERED ROLLER BEARINGS

SINGLE-ROW • IsoClass

IsoClass



Bearing Dimensions			Load Ratings							Part Number		
Bore d	O.D. D	Width T	Dynamic ⁽¹⁾		Factors ⁽²⁾		Dynamic ⁽³⁾		Factors ⁽²⁾		Static C ₀	Assembly Inner/Outer
			C ₁	e	Y	C ₉₀	C _{a90}	K				
mm in.	mm in.	mm in.	N lbf			N lbf	N lbf		N lbf			
160.000 6.2992	240.000 9.4488	51.000 2.0079	480000 108000	0.46	1.31	125000 28000	97800 22000	1.27	853000 192000		32032X	
170.000 6.6929	230.000 9.0551	38.000 1.4961	355000 79800	0.38	1.57	92000 20700	60400 13600	1.52	652000 146000		32934	
180.000 7.0866	250.000 9.8425	45.000 1.7717	403000 90600	0.48	1.25	105000 23500	85900 19300	1.22	795000 179000		32936	
180.000 7.0866	280.000 11.0236	64.000 2.5197	707000 159000	0.42	1.42	183000 41200	133000 29800	1.38	1240000 280000		32036X	
190.000 7.4803	290.000 11.4173	64.000 2.5197	719000 162000	0.44	1.36	186000 41900	141000 31700	1.32	1290000 290000		32038X	
200.000 7.8740	280.000 11.0236	51.000 2.0079	561000 126000	0.39	1.52	145000 32700	98300 22100	1.48	1050000 235000		32940	
220.000 8.6614	300.000 11.8110	51.000 2.0079	561000 126000	0.43	1.41	145000 32700	106000 23800	1.37	1090000 245000		32944	
220.000 8.6614	300.000 11.8110	51.000 2.0079	561000 126000	0.43	1.41	145000 32700	106000 23800	1.37	1090000 245000		32944	
220.000 8.6614	340.000 13.3858	76.000 2.9921	994000 223000	0.43	1.39	258000 57900	190000 42700	1.36	1800000 405000		32044X	
220.000 8.6614	400.000 15.7480	72.000 2.8346	1260000 283000	0.42	1.43	327000 73400	235000 52800	1.39	1560000 350000		30244	
220.000 8.6614	400.000 15.7480	114.000 4.4882	2120000 476000	0.44	1.38	549000 123000	409000 92000	1.34	3010000 677000		32244	
240.000 9.4488	360.000 14.1732	76.000 2.9921	1180000 266000	0.46	1.31	306000 68900	241000 54100	1.27	1940000 435000		32048X	
260.000 10.2362	400.000 15.7480	87.000 3.4252	1520000 341000	0.43	1.38	394000 88500	293000 65900	1.34	2440000 548000		32052X	
260.000 10.2362	480.000 18.8976	137.000 5.3937	2860000 642000	0.43	1.39	741000 167000	546000 123000	1.36	4140000 930000		32252	
280.000 11.0236	380.000 14.9606	63.500 2.5000	850000 191000	0.43	1.39	220000 49500	163000 36700	1.35	1780000 401000		32956	
280.000 11.0236	380.000 14.9606	63.500 2.5000	850000 191000	0.43	1.39	220000 49500	163000 36700	1.35	1780000 401000		32956	
280.000 11.0236	420.000 16.5354	87.000 3.4252	1380000 309000	0.46	1.31	357000 80200	280000 63000	1.27	2620000 590000		32056X	

⁽¹⁾Based on 1 x 10⁶ revolutions L₁₀ life, for the ISO life-calculation method.

⁽²⁾Consult your Timken engineer for instructions on use or review the Timken Engineering Manual on timken.com/catalogs.

⁽³⁾Based on 90 x 10⁶ revolutions L₁₀ life, for The Timken Company life-calculation method. C₉₀ and C_{a90} are radial and thrust values.

Bearing Dimensions											Geometry Factors			Bearing Weight
Width B	Width C	Eff. Ctr. a ⁽⁴⁾	Shaft			Housing			Cage		G ₁	G ₂	C _g	
			Max Shaft Fillet Radius R ⁽⁵⁾	Backing Shoulder Dia. d _a d _b		Max Housing Fillet Radius r ⁽⁵⁾	Backing Shoulder Dia. D _a D _b		A _a ⁽⁶⁾	A _b ⁽⁷⁾				
mm in.	mm in.	mm in.	mm in.	mm in.	mm in.	mm in.	mm in.	mm in.	mm in.	mm in.				kg lbs.
51.000 2.0079	38.000 1.4961	1.8 0.07	3.0 0.12	174.0 6.85	181.0 7.13	2.5 0.10	234.0 9.21	221.0 8.70	3.5 0.13	4.1 0.16	521.7	133.9	0.1166	7.81 17.21
38.000 1.4961	30.000 1.1811	3.8 0.15	2.5 0.10	179.0 7.05	183.0 7.20	2.0 0.08	223.0 8.78	215.0 8.46	2.0 0.08	4.6 0.18	519.3	180.0	0.1305	4.40 9.71
45.000 1.7717	34.000 1.3386	8.9 0.35	2.5 0.10	192.0 7.56	195.0 7.72	2.0 0.08	243.0 9.57	231.0 9.09	4.0 0.15	2.3 0.09	601.8	184.5	0.1236	6.47 14.27
64.000 2.5197	48.000 1.8898	-3.6 -0.14	3.0 0.12	197.0 7.76	203.0 7.99	2.5 0.10	270.0 10.63	256.0 10.08	6.2 0.24	3.8 0.15	760.6	147.5	0.1289	13.98 30.81
64.000 2.5197	48.000 1.8898	-0.5 -0.02	3.0 0.12	207.0 8.15	214.0 8.43	2.5 0.10	281.0 11.06	267.0 10.51	6.4 0.25	4.0 0.16	828.7	161.7	0.1344	14.60 32.18
51.000 2.0079	39.000 1.5354	3.0 0.12	3.0 0.12	213.0 8.39	217.0 8.54	2.5 0.10	272.0 10.71	262.0 10.31	4.6 0.18	1.4 0.06	843.3	220.2	0.1298	9.45 20.84
51.000 2.0079	39.000 1.5354	8.1 0.32	3.0 0.12	232.0 9.13	237.0 9.33	2.5 0.10	290.0 11.42	281.0 11.06	4.7 0.18	3.2 0.13	909.0	153.0	0.1361	9.90 21.83
51.000 2.0079	39.000 1.5354	8.1 0.32	3.0 0.12	232.0 9.13	237.0 9.33	2.5 0.10	290.0 11.42	281.0 11.06	4.7 0.18	3.4 0.14	909.0	153.0	0.1361	9.89 21.81
76.000 2.9921	57.000 2.2441	-3.3 -0.13	4.0 0.16	241.0 9.49	248.0 9.76	3.0 0.12	325.0 12.80	312.0 12.28	10.3 0.40	4.0 0.16	1207.8	127.4	0.1509	23.97 52.86
65.000 2.5591	54.000 2.1260	5.1 0.20	5.1 0.20	245.0 9.65	252.0 9.92	4.0 0.16	371.0 14.61	364.0 14.33	7.9 0.31	9.6 0.38	1012.1	104.0	0.1400	35.25 77.71
108.000 4.2520	90.000 3.5433	-15.0 -0.59	5.0 0.20	251.0 9.88	268.0 10.55	4.0 0.16	379.5 14.94	362.0 14.25	11.0 0.43	7.0 0.28	1607.6	113.5	0.1669	59.41 130.98
76.000 2.9921	57.000 2.2441	2.2 0.09	4.0 0.16	259.0 10.20	268.0 10.55	3.0 0.12	346.0 13.62	331.0 13.03	10.5 0.41	4.4 0.17	1385.0	145.0	0.1610	25.73 56.71
87.000 3.4252	65.000 2.5591	-1.5 -0.06	5.0 0.20	284.0 11.18	293.0 11.54	4.0 0.16	382.5 15.06	367.0 14.45	10.9 0.43	4.0 0.16	1752.5	154.0	0.1711	37.84 83.44
130.000 5.1181	106.000 4.1732	-22.8 -0.90	6.0 0.24	306.0 12.05	315.0 12.40	5.0 0.20	454.5 17.89	432.0 17.01	18.2 0.72	9.3 0.37	2419.2	141.7	0.1902	103.96 229.19
63.500 2.5000	48.000 1.8898	11.4 0.45	3.0 0.12	296.0 11.65	300.0 11.81	2.5 0.10	368.0 14.49	356.0 14.02	7.3 0.29	3.4 0.14	1696.5	236.2	0.1680	19.81 43.69
63.500 2.5000	48.000 1.8898	11.4 0.45	3.0 0.12	296.0 11.65	300.0 11.81	2.5 0.10	368.0 14.49	356.0 14.02	7.3 0.29	3.4 0.14	1696.5	236.2	0.1680	19.81 43.69
87.000 3.4252	65.000 2.5591	3.8 0.15	5.0 0.20	302.0 11.89	314.0 12.36	4.0 0.16	402.0 15.83	388.1 15.28	11.3 0.44	4.1 0.16	1981.1	175.3	0.1812	40.30 88.84

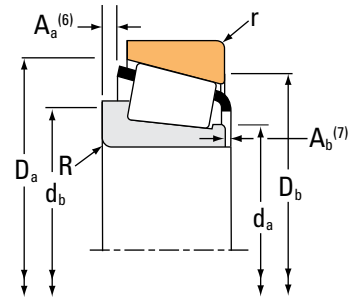
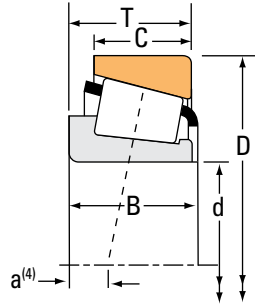
⁽⁴⁾Negative value indicates effective center inside cone (inner-ring) backface.
⁽⁵⁾These maximum fillet radii will be cleared by the bearing corners.
⁽⁶⁾Negative value indicates cage extends beyond cone (inner-ring) backface.
⁽⁷⁾Negative value indicates cage that does not extend beyond cone (inner-ring) front face.

Continued on next page.

TAPERED ROLLER BEARINGS

SINGLE-ROW • IsoClass

IsoClass



Bearing Dimensions			Load Ratings						Part Number		
Bore d	O.D. D	Width T	Dynamic ⁽¹⁾		Factors ⁽²⁾		Dynamic ⁽³⁾		Factors ⁽²⁾	Static	Assembly Inner/Outer
			C ₁	e	Y	C ₉₀	C _{a90}	K	C ₀		
mm in.	mm in.	mm in.	N lbf			N lbf	N lbf		N lbf		
320.000 12.5984	480.000 18.8976	100.000 3.9370	1800000 406000	0.46	1.31	468000 105000	367000 82600	1.27	3420000 768000	32064X	
320.000 12.5984	480.000 18.8976	100.000 3.9370	1800000 406000	0.46	1.31	468000 105000	367000 82600	1.27	3420000 768000	32064X	
340.000 13.3858	460.000 18.1102	76.000 2.9921	1220000 274000	0.44	1.37	316000 71000	237000 53200	1.34	2640000 594000	32968	
360.000 14.1732	480.000 18.8976	76.000 2.9921	1250000 281000	0.46	1.31	324000 72800	254000 57100	1.27	2780000 624000	32972	

⁽¹⁾Based on 1×10^6 revolutions L_{10} life, for the ISO life-calculation method.

⁽²⁾Consult your Timken engineer for instructions on use or review the Timken Engineering Manual on timken.com/catalogs.

⁽³⁾Based on 90×10^6 revolutions L_{10} life, for The Timken Company life-calculation method. C_{90} and C_{a90} are radial and thrust values.

Bearing Dimensions											Geometry Factors			Bearing Weight
Width B	Width C	Eff. Ctr. a ⁽⁴⁾	Shaft			Housing			Cage		G ₁	G ₂	C _g	
			Max Shaft Fillet Radius R ⁽⁵⁾	Backing Shoulder Dia. d _a d _b		Max Housing Fillet Radius r ⁽⁵⁾	Backing Shoulder Dia. D _a D _b		A _a ⁽⁶⁾	A _b ⁽⁷⁾				
mm in.	mm in.	mm in.	mm in.	mm in.	mm in.	mm in.	mm in.	mm in.	mm in.	mm in.				kg lbs.
100.000 3.9370	74.000 2.9134	4.3 0.17	5.0 0.20	343.0 13.50	357.0 14.06	4.0 0.16	461.0 18.15	442.0 17.40	13.5 0.53	5.3 0.21	2667.3	201.4	0.1998	59.62 131.44
100.000 3.9370	74.000 2.9134	4.3 0.17	5.0 0.20	343.0 13.50	357.0 14.06	4.0 0.16	461.0 18.15	442.0 17.40	13.5 0.53	5.3 0.21	2667.3	201.4	0.1998	59.62 131.44
76.000 2.9921	57.000 2.2441	14.7 0.58	4.0 0.16	359.0 14.13	364.0 14.33	3.0 0.12	446.0 17.56	432.0 17.01	10.5 0.41	4.2 0.17	2703.6	309.5	0.1967	34.46 75.96
76.000 2.9921	57.000 2.2441	20.6 0.81	4.0 0.16	378.0 14.88	385.0 15.16	3.0 0.12	466.0 18.35	451.0 17.76	10.8 0.42	4.2 0.17	2984.5	344.6	0.2061	45.22 79.84

⁽⁴⁾Negative value indicates effective center inside cone (inner-ring) backface.
⁽⁵⁾These maximum fillet radii will be cleared by the bearing corners.
⁽⁶⁾Negative value indicates cage extends beyond cone (inner-ring) backface.
⁽⁷⁾Negative value indicates cage that does not extend beyond cone (inner-ring) front face.

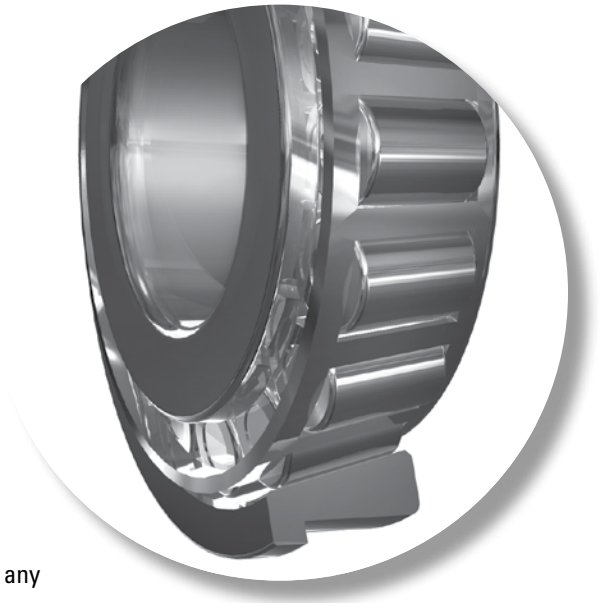
Continued on next page.

TAPERED ROLLER BEARINGS

SINGLE-ROW • TYPE TSF

TYPE TSF

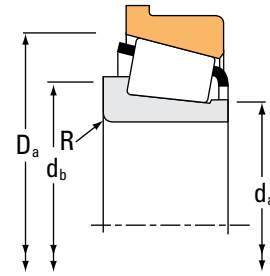
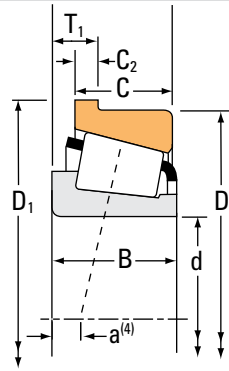
- Type TSF is a single-row bearing with a flange on the outer ring.
- The flange is used for axial location in a housing.
- Through-boring of the housing results in accurately aligned seats.
- The flange is not normally clamped in position.
- Flanged outer rings can be used with any single inner ring from the same series.
- The most commonly specified inner ring part numbers are shown in the tables provided.
- Consult your Timken engineer before making a final bearing selection to help ensure suitability, availability and the most cost-effective application.



TAPERED ROLLER BEARINGS

SINGLE-ROW • TYPE TSF

TYPE TSF



Bearing Dimensions			Load Ratings							Part Number	
Bore d	O.D. D	Width T ₁	Dynamic ⁽¹⁾			Dynamic ⁽³⁾			Static C ₀	Inner	Outer
			C ₁	e	Y	C ₉₀	C _{a90}	K			
mm in.	mm in.	mm in.	N lbf			N lbf	N lbf		N lbf		
7.937 0.3125	31.991 1.2595	4.458 0.1755	10800 2430	0.41	1.48	2800 630	1940 437	1.44	9230 2070	A2031	A2126-B
9.525 0.3750	31.991 1.2595	4.458 0.1755	10800 2430	0.41	1.48	2800 630	1940 437	1.44	9230 2070	A2037	A2126-B
**11.987 0.4719	31.991 1.2595	4.458 0.1755	10800 2430	0.41	1.48	2800 630	1940 437	1.44	9230 2070	A2047	A2126-B
12.700 0.5000	34.988 1.3775	4.630 0.1823	13200 2960	0.45	1.32	3410 767	2640 594	1.29	11500 2580	A4050	A4138-B
**14.989 0.5901	34.988 1.3775	4.630 0.1823	13200 2960	0.45	1.32	3410 767	2640 594	1.29	11500 2580	A4059	A4138-B
15.875 0.6250	47.000 1.8504	6.038 0.2377	26700 6010	0.36	1.68	6930 1560	4230 952	1.64	25400 5720	05062	05185-B
15.875 0.6250	42.862 1.6875	6.350 0.2500	31400 7070	0.33	1.81	8150 1830	4620 1040	1.76	29200 6560	17580	17520-B
15.875 0.6250	39.992 1.5745	4.851 0.1910	13400 3020	0.53	1.14	3480 782	3140 705	1.11	12300 2770	A6062	A6157-B
16.993 0.6690	47.000 1.8504	6.038 0.2377	26700 6010	0.36	1.68	6930 1560	4230 952	1.64	25400 5720	05066	05185-B
16.993 0.6690	39.992 1.5745	4.851 0.1910	13400 3020	0.53	1.14	3480 782	3140 705	1.11	12300 2770	A6067	A6157-B
19.050 0.7500	56.896 2.2400	7.455 0.2935	45400 10200	0.31	1.95	11800 2650	6200 1390	1.90	45300 10200	1775	1729-B
19.050 0.7500	53.975 2.1250	10.317 0.4062	55100 12400	0.59	1.02	14300 3210	14400 3250	0.99	42500 9560	21075	21212-B
19.050 0.7500	49.225 1.9380	6.998 0.2755	42800 9630	0.27	2.26	11100 2500	5050 1140	2.20	40500 9100	09067	09195AB
19.050 0.7500	47.000 1.8504	6.038 0.2377	26700 6010	0.36	1.68	6930 1560	4230 952	1.64	25400 5720	05075	05185-B
19.050 0.7500	47.000 1.8504	14.381 0.5662	26700 6010	0.36	1.68	6930 1560	4230 952	1.64	25400 5720	05075X	05185-B
19.050 0.7500	39.992 1.5745	4.851 0.1910	13400 3020	0.53	1.14	3480 782	3140 705	1.11	12300 2770	A6075	A6157-B
*19.987 0.7869	47.000 1.8504	6.048 0.2381	26700 6010	0.36	1.68	6930 1560	4230 952	1.64	25400 5720	05079	05185-B

⁽¹⁾Based on 1×10^6 revolutions L_{10} life, for the ISO life-calculation method.

⁽²⁾Consult your Timken engineer for instructions on use or review the Timken Engineering Manual on timken.com/catalogs.

⁽³⁾Based on 90×10^6 revolutions L_{10} life, for The Timken Company life-calculation method. C_{90} and C_{a90} are radial and thrust values.

**For standard class (2 or 4) only, the maximum metric value is a whole millimeter dimension.

Bearing Dimensions									Geometry Factors			Bearing Weight
Width B	Width C	Eff. Ctr. a ⁽⁴⁾	Outer Ring Flange O.D. D ₁	Flange Width C ₂	Shaft			Housing	G ₁	G ₂	C _g	
					Max Shaft Fillet Radius R ⁽⁵⁾	Backing Shoulder Dia. d _a	Backing Shoulder Dia. d _b	Backing Shoulder Dia. D _a				
mm in.	mm in.	mm in.	mm in.	mm in.	mm in.	mm in.	mm in.	mm in.				kg lbs.
10.785 0.4246	7.938 0.3125	-3.0 -0.12	35.166 1.3845	2.388 0.0940	0.5 0.02	12.5 0.49	13.0 0.51	30.0 1.18	1.7	3.2	0.0308	0.05 0.11
10.785 0.4246	7.938 0.3125	-3.0 -0.12	35.166 1.3845	2.388 0.0940	1.3 0.05	13.5 0.53	15.0 0.59	30.0 1.18	1.7	3.2	0.0308	0.05 0.11
10.785 0.4246	7.938 0.3125	-3.0 -0.12	35.166 1.3845	2.388 0.0940	0.8 0.03	15.5 0.61	16.5 0.65	30.0 1.18	1.7	3.2	0.0308	0.04 0.10
10.988 0.4326	8.730 0.3437	-2.5 -0.10	38.062 1.4985	2.362 0.0930	1.3 0.05	17.0 0.67	18.5 0.73	33.5 1.32	2.3	4.1	0.0355	0.05 0.12
10.988 0.4326	8.730 0.3437	-2.5 -0.10	38.062 1.4985	2.362 0.0930	0.8 0.03	19.0 0.75	19.5 0.77	33.5 1.32	2.3	4.1	0.0355	0.04 0.12
14.381 0.5662	11.112 0.4375	-4.1 -0.16	50.861 2.0024	2.769 0.1090	1.5 0.06	21.0 0.83	23.5 0.93	44.5 1.75	5.8	5.5	0.0448	0.14 0.31
16.670 0.6563	13.495 0.5313	-5.8 -0.23	45.936 1.8085	3.175 0.1250	1.5 0.06	21.0 0.83	23.0 0.91	40.5 1.59	5.3	4.5	0.0423	0.12 0.29
11.153 0.4391	9.525 0.3750	-1.5 -0.06	43.066 1.6955	2.362 0.0930	1.3 0.05	20.5 0.81	22.0 0.87	38.0 1.50	2.9	5.6	0.0404	0.09 0.17
14.381 0.5662	11.112 0.4375	-4.1 -0.16	50.861 2.0024	2.769 0.1090	1.5 0.06	22.0 0.87	24.5 0.96	44.5 1.75	5.8	5.5	0.0448	0.14 0.30
11.153 0.4391	9.525 0.3750	-1.5 -0.06	43.066 1.6955	2.362 0.0930	0.8 0.03	21.0 0.83	22.0 0.87	38.0 1.50	2.9	5.6	0.0404	0.09 0.17
19.837 0.7810	15.875 0.6250	-6.9 -0.27	60.757 2.3920	3.962 0.1560	1.5 0.06	25.0 0.98	27.0 1.06	53.0 2.09	10.6	5.4	0.0521	0.27 0.62
21.839 0.8598	15.875 0.6250	-5.8 -0.23	57.841 2.2772	3.967 0.1562	1.5 0.06	26.0 1.03	31.5 1.24	52.0 2.05	7.0	4.1	0.0558	0.26 0.57
19.050 0.7500	14.288 0.5625	-7.4 -0.29	53.081 2.0898	3.251 0.1280	1.3 0.05	24.0 0.94	25.5 1.00	46.5 1.83	8.0	4.0	0.0452	0.18 0.40
14.381 0.5662	11.112 0.4375	-4.1 -0.16	50.861 2.0024	2.769 0.1090	1.3 0.05	23.5 0.93	25.0 0.98	44.5 1.75	5.8	5.5	0.0448	0.13 0.29
14.381 0.5662	11.112 0.4375	-4.1 -0.16	50.861 2.0024	2.769 0.1090	1.5 0.06	23.5 0.93	25.4 1.00	44.5 1.75	5.8	5.5	0.0448	0.13 0.29
11.153 0.4391	9.525 0.3750	-1.5 -0.06	43.066 1.6955	2.362 0.0930	1.0 0.04	23.0 0.91	24.0 0.94	38.0 1.50	2.9	5.6	0.0404	0.08 0.16
14.381 0.5662	11.112 0.4375	-4.1 -0.16	50.861 2.0024	2.769 0.1090	1.5 0.06	24.0 0.94	26.5 1.04	44.5 1.75	5.8	5.5	0.0448	0.13 0.28

⁽⁴⁾Negative value indicates effective center inside cone Metric.

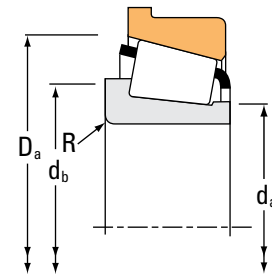
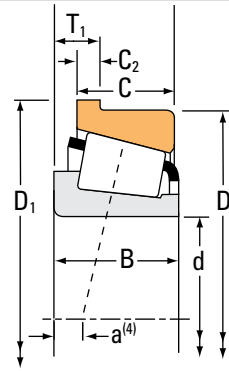
⁽⁵⁾These maximum fillet radii will be cleared by the bearing corners.

Continued on next page.

TAPERED ROLLER BEARINGS

SINGLE-ROW • TYPE TSF

TYPE TSF



Bearing Dimensions			Load Ratings							Part Number		
Bore d	O.D. D	Width T ₁	Dynamic ⁽¹⁾		Factors ⁽²⁾		Dynamic ⁽³⁾		Factors ⁽²⁾	Static C ₀	Inner	Outer
			C ₁	e	Y	C ₉₀	C _{a90}	K	C ₀			
mm in.	mm in.	mm in.	N lbf			N lbf	N lbf		N lbf			
**20.000 0.7874	51.994 2.0470	5.080 0.2000	29100 6540	0.40	1.49	7550 1700	5190 1170	1.45	29600 6650		07079	07204-B
20.625 0.8120	49.225 1.9380	8.809 0.3468	42800 9630	0.27	2.26	11100 2500	5050 1140	2.20	40500 9100		09081	09195AB
20.637 0.8125	61.912 2.4375	9.525 0.3750	88600 19900	0.28	2.13	23000 5160	11100 2500	2.07	89800 20200		3660	3620-B
22.225 0.8750	66.421 2.6150	8.725 0.3435	76600 17200	0.25	2.36	19900 4470	8640 1940	2.30	81700 18400		2684	2631-B
22.225 0.8750	60.325 2.3750	7.938 0.3125	48400 10900	0.33	1.82	12500 2820	7080 1590	1.77	50200 11300		1975	1931-B
22.225 0.8750	56.896 2.2400	7.463 0.2938	45400 10200	0.31	1.95	11800 2650	6200 1390	1.90	45300 10200		1755	1729-B
22.225 0.8750	51.994 2.0470	5.080 0.2000	29100 6540	0.40	1.49	7550 1700	5190 1170	1.45	29600 6650		07087	07204-B
22.225 0.8750	50.800 2.0000	5.080 0.2000	29100 6540	0.40	1.49	7550 1700	5190 1170	1.45	29600 6650		07087X	07210XB
22.225 0.8750	50.005 1.9687	6.749 0.2657	29100 6540	0.40	1.49	7550 1700	5190 1170	1.45	29600 6650		07087	07196-B
23.812 0.9375	72.000 2.8346	7.087 0.2790	58800 13200	0.36	1.67	15200 3420	9390 2110	1.62	60100 13500		26093	26283-B
23.812 0.9375	56.896 2.2400	7.463 0.2938	45400 10200	0.31	1.95	11800 2650	6200 1390	1.90	45300 10200		1779	1729-B
23.812 0.9375	51.994 2.0470	5.080 0.2000	29100 6540	0.40	1.49	7550 1700	5190 1170	1.45	29600 6650		07093	07204-B
24.981 0.9835	51.994 2.0470	5.080 0.2000	29100 6540	0.40	1.49	7550 1700	5190 1170	1.45	29600 6650		07098	07204-B
24.981 0.9835	50.005 1.9687	6.749 0.2657	29100 6540	0.40	1.49	7550 1700	5190 1170	1.45	29600 6650		07098	07196-B
25.400 1.0000	72.625 2.8593	11.112 0.4375	94800 21300	0.33	1.80	24600 5520	14000 3140	1.76	102000 22800		3189	3120-B
25.400 1.0000	72.625 2.8593	12.700 0.5000	82600 18600	0.60	1.00	21400 4820	22100 4960	0.97	64100 14400		41100	41286-B
25.400 1.0000	72.000 2.8346	7.087 0.2790	58800 13200	0.36	1.67	15200 3420	9390 2110	1.62	60100 13500		26100	26283-B

⁽¹⁾Based on 1×10^6 revolutions L_{10} life, for the ISO life-calculation method.

⁽²⁾Consult your Timken engineer for instructions on use or review the Timken Engineering Manual on timken.com/catalogs.

⁽³⁾Based on 90×10^6 revolutions L_{10} life, for The Timken Company life-calculation method. C_{90} and C_{a90} are radial and thrust values.

**For standard class (2 or 4) only, the maximum metric value is a whole millimeter dimension.

Bearing Dimensions									Geometry Factors			Bearing Weight
Width B	Width C	Eff. Ctr. a ⁽⁴⁾	Outer Ring Flange O.D. D ₁	Flange Width C ₂	Shaft			Housing	G ₁	G ₂	C _g	
					Max Shaft Fillet Radius R ⁽⁵⁾	Backing Shoulder Dia.		Backing Shoulder Dia. D _a				
mm in.	mm in.	mm in.	mm in.	mm in.	mm in.	mm in.	mm in.	mm in.				kg lbs.
14.260 0.5614	12.700 0.5000	-2.8 -0.11	55.855 2.1990	2.769 0.1090	1.5 0.06	26.0 1.02	27.5 1.08	50.0 1.97	7.6	7.1	0.0509	0.17 0.38
21.539 0.8480	14.288 0.5625	-9.1 -0.36	53.081 2.0898	3.251 0.1280	1.5 0.06	25.4 1.00	27.5 1.08	46.5 1.83	8.0	4.0	0.0452	0.18 0.40
30.417 1.1975	23.812 0.9375	-11.9 -0.47	66.571 2.6209	4.762 0.1875	2.3 0.09	29.5 1.16	33.5 1.32	59.0 2.32	17.0	6.4	0.0592	0.49 1.07
25.433 1.0013	19.050 0.7500	-9.4 -0.37	70.282 2.7670	3.962 0.1560	1.5 0.06	32.0 1.26	34.0 1.34	62.0 2.44	19.3	8.0	0.0598	0.47 1.04
19.355 0.7620	15.875 0.6250	-5.8 -0.23	64.186 2.5270	3.967 0.1562	0.8 0.03	29.5 1.16	30.5 1.20	57.0 2.24	12.5	6.3	0.0565	0.30 0.68
19.837 0.7810	15.875 0.6250	-6.9 -0.27	60.757 2.3920	3.962 0.1560	1.3 0.05	27.5 1.08	29.0 1.14	53.0 2.09	10.6	5.4	0.0521	0.26 0.58
14.260 0.5614	12.700 0.5000	-2.8 -0.11	55.855 2.1990	2.769 0.1090	1.3 0.05	27.0 1.06	28.5 1.12	50.0 1.97	7.6	7.1	0.0509	0.16 0.36
14.260 0.5614	12.700 0.5000	-2.8 -0.11	54.762 2.1560	2.769 0.1090	1.5 0.06	27.0 1.06	29.0 1.14	49.0 1.93	7.6	7.1	0.0509	0.15 0.34
14.260 0.5614	9.525 0.3750	-2.8 -0.11	53.871 2.1209	2.779 0.1094	1.3 0.05	27.0 1.06	28.5 1.12	49.0 1.93	7.6	7.1	0.0509	0.13 0.30
18.923 0.7450	15.875 0.6250	-4.1 -0.16	75.857 2.9865	3.962 0.1560	2.3 0.09	31.0 1.22	35.0 1.38	66.0 2.60	16.1	10.1	0.0630	0.43 0.96
19.837 0.7810	15.875 0.6250	-6.9 -0.27	60.757 2.3920	3.962 0.1560	0.8 0.03	28.5 1.12	29.5 1.16	53.0 2.09	10.6	5.4	0.0521	0.25 0.56
14.260 0.5614	12.700 0.5000	-2.8 -0.11	55.855 2.1990	2.769 0.1090	1.5 0.06	28.5 1.12	30.5 1.20	50.0 1.97	7.6	7.1	0.0509	0.16 0.34
14.260 0.5614	12.700 0.5000	-2.8 -0.11	55.855 2.1990	2.769 0.1090	1.5 0.06	29.0 1.14	31.0 1.22	50.0 1.97	7.6	7.1	0.0509	0.15 0.33
14.260 0.5614	9.525 0.3750	-2.8 -0.11	53.871 2.1209	2.779 0.1094	1.5 0.06	29.0 1.14	31.0 1.22	49.0 1.93	7.6	7.1	0.0509	0.12 0.27
29.997 1.1810	23.812 0.9375	-10.2 -0.40	77.300 3.0433	4.762 0.1875	0.8 0.03	35.0 1.38	35.5 1.40	69.0 2.72	23.4	8.8	0.0697	0.68 1.49
24.257 0.9550	17.462 0.6875	-4.1 -0.16	78.082 3.0741	5.555 0.2187	2.3 0.09	36.5 1.44	41.0 1.61	70.0 2.76	13.0	5.8	0.0686	0.52 1.16
18.923 0.7450	15.875 0.6250	-4.1 -0.16	75.857 2.9865	3.962 0.1560	1.5 0.06	32.5 1.28	34.5 1.36	66.0 2.60	16.1	10.1	0.0630	0.42 0.94

⁽⁴⁾Negative value indicates effective center inside cone Metric.

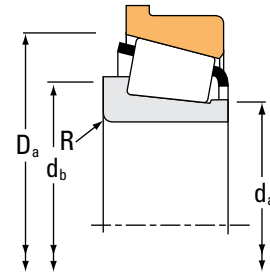
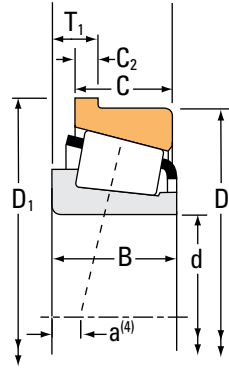
⁽⁵⁾These maximum fillet radii will be cleared by the bearing corners.

Continued on next page.

TAPERED ROLLER BEARINGS

SINGLE-ROW • TYPE TSF

TYPE TSF



Bearing Dimensions			Load Ratings							Part Number		
Bore d	O.D. D	Width T ₁	Dynamic ⁽¹⁾		Factors ⁽²⁾		Dynamic ⁽³⁾		Factors ⁽²⁾	Static C ₀	Inner	Outer
			C ₁	e	Y	C ₉₀	C _{a90}	K	C ₀			
mm in.	mm in.	mm in.	N lbf			N lbf	N lbf		N lbf			
25.400 1.0000	68.262 2.6875	8.730 0.3437	63800 14300	0.42	1.44	16500 3720	11800 2650	1.40	70200 15800		02473	02420-B
25.400 1.0000	66.421 2.6150	8.725 0.3435	76600 17200	0.25	2.36	19900 4470	8640 1940	2.30	81700 18400		2687	2631-B
25.400 1.0000	65.088 2.5625	10.320 0.4063	54600 12300	0.73	0.82	14200 3180	17700 3990	0.80	55800 12500		23100	23256-B
25.400 1.0000	60.325 2.3750	7.938 0.3125	48400 10900	0.33	1.82	12500 2820	7080 1590	1.77	50200 11300		1986	1931-B
25.400 1.0000	58.738 2.3125	7.938 0.3125	48400 10900	0.33	1.82	12500 2820	7080 1590	1.77	50200 11300		1986	1932-B
25.400 1.0000	57.150 2.2500	7.938 0.3125	54500 12300	0.35	1.73	14100 3180	8380 1880	1.69	50100 11300		15578	15520-B
25.400 1.0000	50.800 2.0000	5.080 0.2000	29100 6540	0.40	1.49	7550 1700	5190 1170	1.45	29600 6650		07100-SA	07210XB
26.975 1.0620	60.325 2.3750	7.938 0.3125	48400 10900	0.33	1.82	12500 2820	7080 1590	1.77	50200 11300		1987	1931-B
26.987 1.0625	72.625 2.8593	12.700 0.5000	82600 18600	0.60	1.00	21400 4820	22100 4960	0.97	64100 14400		41106	41286-B
26.987 1.0625	66.421 2.6150	8.725 0.3435	76600 17200	0.25	2.36	19900 4470	8640 1940	2.30	81700 18400		2688	2631-B
28.575 1.1250	72.625 2.8593	11.112 0.4375	94800 21300	0.33	1.80	24600 5520	14000 3140	1.76	102000 22800		3198	3120-B
28.575 1.1250	72.625 2.8593	11.112 0.4375	94800 21300	0.33	1.80	24600 5520	14000 3140	1.76	102000 22800		3192	3120-B
28.575 1.1250	72.625 2.8593	12.700 0.5000	82600 18600	0.60	1.00	21400 4820	22100 4960	0.97	64100 14400		41125	41286-B
28.575 1.1250	72.000 2.8346	7.087 0.2790	69600 15700	0.36	1.67	18100 4060	11100 2500	1.62	60100 13500		26112	26283-B
28.575 1.1250	69.850 2.7500	8.733 0.3438	83700 18800	0.27	2.19	21700 4880	10200 2280	2.14	94400 21200		2578	2523-B
28.575 1.1250	66.421 2.6150	8.725 0.3435	76600 17200	0.25	2.36	19900 4470	8640 1940	2.30	81700 18400		2689	2631-B
28.575 1.1250	60.325 2.3750	7.938 0.3125	48400 10900	0.33	1.82	12500 2820	7080 1590	1.77	50200 11300		1985	1931-B

⁽¹⁾Based on 1 x 10⁶ revolutions L₁₀ life, for the ISO life-calculation method.

⁽²⁾Consult your Timken engineer for instructions on use or review the Timken Engineering Manual on timken.com/catalogs.

⁽³⁾Based on 90 x 10⁶ revolutions L₁₀ life, for The Timken Company life-calculation method. C₉₀ and C_{a90} are radial and thrust values.

Bearing Dimensions									Geometry Factors			Bearing Weight
Width B	Width C	Eff. Ctr. a ⁽⁴⁾	Outer Ring Flange O.D. D ₁	Flange Width C ₂	Shaft			Housing	G ₁	G ₂	C _g	
					Max Shaft Fillet Radius R ⁽⁵⁾	Backing Shoulder Dia.		Backing Shoulder Dia. D _a				
mm in.	mm in.	mm in.	mm in.	mm in.	mm in.	mm in.	mm in.	mm in.				kg lbs.
22.225 0.8750	17.462 0.6875	-5.1 -0.20	72.128 2.8397	3.967 0.1562	0.8 0.03	33.5 1.32	34.5 1.36	65.0 2.56	17.5	8.5	0.0681	0.48 1.06
25.433 1.0013	19.050 0.7500	-9.4 -0.37	70.282 2.7670	3.962 0.1560	1.3 0.05	31.5 1.24	33.5 1.32	62.0 2.44	19.3	8.0	0.0598	0.44 0.99
21.463 0.8450	15.875 0.6250	-2.3 -0.09	68.953 2.7147	3.970 0.1563	1.5 0.06	34.5 1.36	39.0 1.54	63.0 2.48	11.3	6.6	0.0700	0.37 0.83
19.355 0.7620	15.875 0.6250	-5.8 -0.23	64.186 2.5270	3.967 0.1562	1.3 0.05	32.0 1.26	34.0 1.34	57.0 2.24	12.5	6.3	0.0565	0.29 0.64
19.355 0.7620	15.080 0.5937	-5.8 -0.23	62.598 2.4645	3.967 0.1562	1.3 0.05	32.0 1.26	34.0 1.34	56.0 2.20	12.5	6.3	0.0565	0.27 0.59
17.462 0.6875	13.495 0.5313	-5.1 -0.20	61.016 2.4022	3.970 0.1563	1.3 0.05	30.5 1.20	32.5 1.28	60.0 2.36	12.7	10.3	0.0577	0.24 0.52
14.260 0.5614	12.700 0.5000	-2.8 -0.11	54.762 2.1560	2.769 0.1090	3.3 0.13	29.5 1.16	35.0 1.38	49.0 1.93	7.6	7.1	0.0509	0.14 0.30
19.355 0.7620	15.875 0.6250	-5.8 -0.23	64.186 2.5270	3.967 0.1562	0.8 0.03	31.5 1.24	32.5 1.28	57.0 2.24	12.5	6.3	0.0565	0.28 0.62
24.257 0.9550	17.462 0.6875	-4.1 -0.16	78.082 3.0741	5.555 0.2187	2.3 0.09	36.5 1.44	42.0 1.65	70.0 2.76	13.0	5.8	0.0686	0.51 1.13
25.433 1.0013	19.050 0.7500	-9.4 -0.37	70.282 2.7670	3.962 0.1560	1.5 0.06	33.0 1.30	35.0 1.38	62.0 2.44	19.3	8.0	0.0598	0.43 0.96
29.997 1.1810	23.812 0.9375	-10.2 -0.40	77.300 3.0433	4.762 0.1875	1.3 0.05	37.0 1.46	39.0 1.54	69.0 2.72	23.4	8.8	0.0697	0.65 1.42
29.997 1.1810	23.812 0.9375	-10.2 -0.40	77.300 3.0433	4.762 0.1875	3.5 0.14	37.0 1.46	43.5 1.71	69.0 2.72	23.4	8.8	0.0697	0.64 1.41
24.257 0.9550	17.462 0.6875	-4.1 -0.16	78.082 3.0741	5.555 0.2187	4.8 0.19	36.5 1.44	48.0 1.89	70.0 2.76	13.0	5.8	0.0686	0.49 1.09
18.923 0.7450	15.875 0.6250	-4.1 -0.16	75.857 2.9865	3.962 0.1560	1.5 0.06	35.0 1.38	37.0 1.46	66.0 2.60	16.1	10.1	0.0630	0.40 0.90
25.357 0.9983	19.050 0.7500	-8.6 -0.34	73.711 2.9020	3.962 0.1560	2.3 0.09	35.0 1.38	39.0 1.54	66.0 2.60	23.6	9.6	0.0656	0.49 1.09
25.433 1.0013	19.050 0.7500	-9.4 -0.37	70.282 2.7670	3.962 0.1560	1.3 0.05	36.0 1.42	37.5 1.48	62.0 2.44	19.3	8.0	0.0598	0.42 0.93
19.355 0.7620	15.875 0.6250	-5.8 -0.23	64.186 2.5270	3.967 0.1562	0.8 0.03	33.5 1.32	34.0 1.34	57.0 2.24	12.5	6.3	0.0565	0.27 0.59

⁽⁴⁾Negative value indicates effective center inside cone (inner-ring) backface.

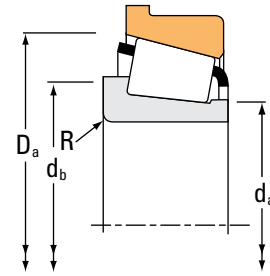
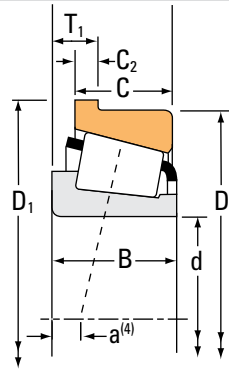
⁽⁵⁾These maximum fillet radii will be cleared by the bearing corners.

Continued on next page.

TAPERED ROLLER BEARINGS

SINGLE-ROW • TYPE TSF

TYPE TSF



Bearing Dimensions			Load Ratings							Part Number		
Bore d	O.D. D	Width T ₁	Dynamic ⁽¹⁾		Factors ⁽²⁾		Dynamic ⁽³⁾		Factors ⁽²⁾	Static C ₀	Inner	Outer
			C ₁	e	Y	C ₉₀	C _{a90}	K	C ₀			
mm in.	mm in.	mm in.	N lbf			N lbf	N lbf		N lbf			
28.575 1.1250	57.150 2.2500	7.938 0.3215	46000 10300	0.35	1.73	11900 2680	7070 1590	1.69	50100 11300		15590	15520-B
29.367 1.1562	66.421 2.6150	8.725 0.3435	76600 17200	0.25	2.36	19900 4470	8640 1940	2.30	81700 18400		2690	2631-B
29.367 1.1562	66.421 2.6150	8.725 0.3435	76600 17200	0.25	2.36	19900 4470	8640 1940	2.30	81700 18400		2691	2631-B
29.987 1.1806	72.000 2.8346	7.087 0.2790	69600 15700	0.36	1.67	18100 4060	11100 2500	1.62	60100 13500		26118	26283-B
29.987 1.1806	68.262 2.6875	8.730 0.3437	63800 14300	0.42	1.44	16500 3720	11800 2650	1.40	70200 15800		02474A	02420-B
**29.987 1.1806	62.000 2.4409	5.270 0.2075	43200 9720	0.38	1.57	11200 2520	7340 1650	1.53	44100 9910		17118	17244-B
30.000 1.1811	72.625 2.8593	11.112 0.4375	94800 21300	0.33	1.80	24600 5520	14000 3140	1.76	102000 22800		3190	3120-B
30.000 1.1811	72.000 2.8346	7.087 0.2790	69600 15700	0.36	1.67	18100 4060	11100 2500	1.62	60100 13500		26118-S	26283-B
30.000 1.1811	69.012 2.7170	7.932 0.3123	54600 12300	0.38	1.57	14200 3180	9260 2080	1.53	61700 13900		14118	14276-B
30.000 1.1811	69.012 2.7170	7.932 0.3123	54600 12300	0.38	1.57	14200 3180	9260 2080	1.53	61700 13900		14117A	14276-B
30.162 1.1875	80.000 3.1496	7.938 0.3125	79500 17900	0.27	2.20	20600 4640	9640 2170	2.14	83400 18700		334	332-B
30.162 1.1875	80.000 3.1496	9.100 0.3583	75200 16900	0.40	1.49	19500 4390	13400 3020	1.45	68900 15500		28118	28315-B
30.162 1.1875	79.375 3.1250	10.320 0.4063	105000 23500	0.37	1.64	27100 6100	17000 3820	1.60	119000 26800		3474	3420-B
30.162 1.1875	72.625 2.8593	11.112 0.4375	94800 21300	0.33	1.80	24600 5520	14000 3140	1.76	102000 22800		3191	3120-B
30.162 1.1875	72.625 2.8593	11.112 0.4375	94800 21300	0.33	1.80	24600 5520	14000 3140	1.76	102000 22800		3187	3120-B
30.162 1.1875	69.850 2.7500	8.733 0.3438	83700 18800	0.27	2.19	21700 4880	10200 2280	2.14	94400 21200		2558	2523-B
30.162 1.1875	64.292 2.5312	8.763 0.3450	60200 13500	0.55	1.10	15600 3510	14600 3280	1.07	71700 16100		M86649	M86611-B

⁽¹⁾Based on 1 x 10⁶ revolutions L₁₀ life, for the ISO life-calculation method.

⁽²⁾Consult your Timken engineer for instructions on use or review the Timken Engineering Manual on timken.com/catalogs.

⁽³⁾Based on 90 x 10⁶ revolutions L₁₀ life, for The Timken Company life-calculation method. C₉₀ and C_{a90} are radial and thrust values.

**For standard class (2 or 4) only, the maximum metric value is a whole millimeter dimension.

Bearing Dimensions									Geometry Factors			Bearing Weight
Width B	Width C	Eff. Ctr. a ⁽⁴⁾	Outer Ring Flange O.D. D ₁	Flange Width C ₂	Shaft			Housing	G ₁	G ₂	C _g	
					Max Shaft Fillet Radius R ⁽⁵⁾	Backing Shoulder Dia.		Backing Shoulder Dia. D _a				
mm in.	mm in.	mm in.	mm in.	mm in.	mm in.	mm in.	mm in.	mm in.				kg lbs.
17.462 0.6875	13.495 0.5313	-5.1 -0.20	61.016 2.4022	3.970 0.1563	3.5 0.14	33.5 1.32	39.5 1.56	60.0 2.36	12.7	10.3	0.0577	0.22 0.47
25.433 1.0013	19.050 0.7500	-9.4 -0.37	70.282 2.7670	3.962 0.1560	3.5 0.14	35.0 1.38	41.0 1.61	62.0 2.44	19.3	8.0	0.0598	0.40 0.91
25.433 1.0013	19.050 0.7500	-9.4 -0.37	70.282 2.7670	3.962 0.1560	0.8 0.03	36.5 1.44	37.5 1.48	62.0 2.44	19.3	8.0	0.0598	0.41 0.92
18.923 0.7450	15.875 0.6250	-4.1 -0.16	75.857 2.9865	3.962 0.1560	1.5 0.06	36.0 1.42	38.0 1.50	66.0 2.60	16.1	10.1	0.0630	0.39 0.88
22.225 0.8750	17.462 0.6875	-5.1 -0.20	72.128 2.8397	3.967 0.1562	0.8 0.03	38.5 1.52	39.5 1.56	65.0 2.56	17.5	8.5	0.0681	0.45 0.99
16.566 0.6522	14.288 0.5625	-3.6 -0.14	65.862 2.5930	3.556 0.1400	1.5 0.06	36.0 1.42	38.5 1.52	59.0 2.32	11.8	7.5	0.0579	0.23 0.53
29.997 1.1810	23.812 0.9375	-10.2 -0.40	77.300 3.0433	4.762 0.1875	3.5 0.14	38.0 1.50	44.5 1.75	69.0 2.72	23.4	8.8	0.0697	0.63 1.37
18.923 0.7450	15.875 0.6250	-4.1 -0.16	75.857 2.9865	3.962 0.1560	1.5 0.06	36.0 1.42	38.0 1.50	66.0 2.60	16.1	10.1	0.0630	0.39 0.88
19.202 0.7560	15.875 0.6250	-4.3 -0.17	72.873 2.8690	3.962 0.1560	0.8 0.03	36.5 1.44	37.0 1.46	65.0 2.56	18.0	13.3	0.0668	0.36 0.82
19.583 0.7710	15.875 0.6250	-4.3 -0.17	72.873 2.8690	3.962 0.1560	3.5 0.14	41.0 1.61	44.0 1.73	65.0 2.56	18.0	13.3	0.0668	0.36 0.82
22.403 0.8820	17.826 0.7018	-6.4 -0.25	84.658 3.3330	4.762 0.1875	0.8 0.03	38.0 1.50	39.0 1.54	77.0 3.03	26.5	13.0	0.0676	0.59 1.32
20.940 0.8244	15.875 0.6250	-4.8 -0.19	83.858 3.3015	3.970 0.1563	1.5 0.06	37.5 1.48	40.0 1.57	73.0 2.87	20.7	12.5	0.0709	0.54 1.21
29.771 1.1721	23.812 0.9375	-8.6 -0.34	84.049 3.3090	4.762 0.1875	0.8 0.03	40.0 1.57	41.0 1.61	76.0 2.99	29.9	11.2	0.0781	0.79 1.73
29.997 1.1810	23.812 0.9375	-10.2 -0.40	77.300 3.0433	4.762 0.1875	3.5 0.14	38.5 1.52	44.5 1.75	69.0 2.72	23.4	8.8	0.0697	0.62 1.37
29.997 1.1810	23.812 0.9375	-10.2 -0.40	77.300 3.0433	4.762 0.1875	0.8 0.03	38.5 1.52	39.0 1.54	69.0 2.72	23.4	8.8	0.0697	0.63 1.38
25.357 0.9983	19.050 0.7500	-8.6 -0.34	73.711 2.9020	3.962 0.1560	2.3 0.09	36.5 1.44	40.0 1.57	66.0 2.60	23.6	9.6	0.0656	0.48 1.06
21.433 0.8438	16.670 0.6563	-3.3 -0.13	70.000 2.7559	4.000 0.1575	1.5 0.06	38.0 1.50	44.0 1.73	63.0 2.48	16.8	7.4	0.0736	0.36 0.79

⁽⁴⁾Negative value indicates effective center inside cone Metric.

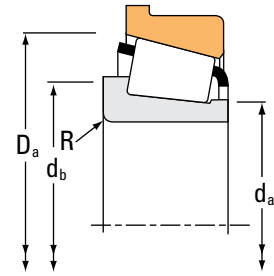
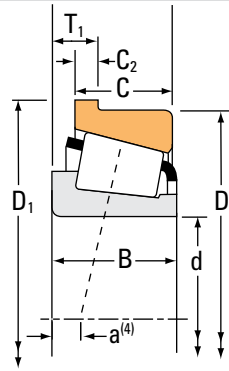
⁽⁵⁾These maximum fillet radii will be cleared by the bearing corners.

Continued on next page.

TAPERED ROLLER BEARINGS

SINGLE-ROW • TYPE TSF

TYPE TSF



Bearing Dimensions			Load Ratings							Part Number	
Bore d	O.D. D	Width T ₁	Dynamic ⁽¹⁾			Dynamic ⁽³⁾			Static C ₀	Inner	Outer
			C ₁	e	Y	C ₉₀	C _{a90}	K			
mm in.	mm in.	mm in.	N lbf			N lbf	N lbf		N lbf		
30.162 1.1875	62.000 2.4409	5.270 0.2075	43200 9720	0.38	1.57	11200 2520	7340 1650	1.53	44100 9910	17119	17244-B
30.213 1.1895	63.500 2.5000	8.730 0.3437	59900 13500	0.35	1.71	15500 3490	9310 2090	1.67	53900 12100	15118	15250-B
31.750 1.2500	80.000 3.1496	7.938 0.3125	94300 21200	0.27	2.20	24400 5490	11400 2570	2.14	83400 18700	346	332-B
31.750 1.2500	79.375 3.1250	10.320 0.4063	105000 23500	0.37	1.64	27100 6100	17000 3820	1.60	119000 26800	3476	3420-B
31.750 1.2500	72.625 2.8593	11.112 0.4375	94800 21300	0.33	1.80	24600 5520	14000 3140	1.76	102000 22800	3188	3120-B
31.750 1.2500	72.625 2.8593	11.112 0.4375	94800 21300	0.33	1.80	24600 5520	14000 3140	1.76	102000 22800	3199	3120-B
31.750 1.2500	72.625 2.8593	11.112 0.4375	94800 21300	0.33	1.80	24600 5520	14000 3140	1.76	102000 22800	3193	3120-B
31.750 1.2500	69.850 2.7500	8.732 0.3438	83700 18800	0.27	2.19	21700 4880	10200 2280	2.14	94400 21200	2582	2523-B
31.750 1.2500	69.850 2.7500	8.733 0.3438	83700 18800	0.27	2.19	21700 4880	10200 2280	2.14	94400 21200	2580	2523-B
31.750 1.2500	69.012 2.7170	7.932 0.3123	54600 12300	0.38	1.57	14200 3180	9260 2080	1.53	61700 13900	14125A	14276-B
31.750 1.2500	68.262 2.6875	8.730 0.3437	63800 14300	0.42	1.44	16500 3720	11800 2650	1.40	70200 15800	02476	02420-B
31.750 1.2500	68.262 2.6875	8.730 0.3437	63800 14300	0.42	1.44	16500 3720	11800 2650	1.40	70200 15800	02475	02420-B
31.750 1.2500	63.500 2.5000	7.841 0.3087	59900 13500	0.35	1.71	15500 3490	9310 2090	1.67	53900 12100	15123	15250-B
31.750 1.2500	63.500 2.5000	8.730 0.3437	59900 13500	0.35	1.71	15500 3490	9310 2090	1.67	53900 12100	15125	15250-B
31.750 1.2500	59.131 2.3280	6.833 0.2690	46700 10500	0.41	1.46	12100 2720	8550 1920	1.42	44600 10000	LM67047	LM67010-B
31.750 1.2500	59.131 2.3280	6.833 0.2690	46700 10500	0.41	1.46	12100 2720	8550 1920	1.42	44600 10000	LM67048	LM67010-B
31.750 1.2500	58.877 2.3180	6.833 0.2690	46700 10500	0.41	1.46	12100 2720	8550 1920	1.42	44600 10000	LM67048	LM67010-BA

⁽¹⁾Based on 1×10^6 revolutions L_{10} life, for the ISO life-calculation method.

⁽²⁾Consult your Timken engineer for instructions on use or review the Timken Engineering Manual on timken.com/catalogs.

⁽³⁾Based on 90×10^6 revolutions L_{10} life, for The Timken Company life-calculation method. C_{90} and C_{a90} are radial and thrust values.

Bearing Dimensions									Geometry Factors			Bearing Weight
Width B	Width C	Eff. Ctr. a ⁽⁴⁾	Outer Ring Flange O.D. D ₁	Flange Width C ₂	Shaft			Housing	G ₁	G ₂	C _g	
					Max Shaft Fillet Radius R ⁽⁵⁾	Backing Shoulder Dia.		Backing Shoulder Dia. D _a				
mm in.	mm in.	mm in.	mm in.	mm in.	mm in.	mm in.	mm in.	mm in.				kg lbs.
16.566 0.6522	14.288 0.5625	-3.6 -0.14	65.862 2.5930	3.556 0.1400	1.5 0.06	34.5 1.36	37.0 1.46	59.0 2.32	11.8	7.5	0.0579	0.23 0.53
20.638 0.8125	15.875 0.6250	-5.8 -0.23	67.366 2.6522	3.967 0.1562	3.5 0.14	36.5 1.44	43.0 1.69	60.0 2.36	14.6	10.0	0.0606	0.31 0.68
22.403 0.8820	17.826 0.7018	-6.4 -0.25	84.658 3.3330	4.762 0.1875	0.8 0.03	39.5 1.56	40.0 1.57	77.0 3.03	26.5	13.0	0.0676	0.58 1.29
29.771 1.1721	23.812 0.9375	-8.6 -0.34	84.049 3.3090	4.762 0.1875	1.3 0.05	41.0 1.61	43.0 1.69	76.0 2.99	29.9	11.2	0.0781	0.77 1.69
29.997 1.1810	23.812 0.9375	-10.2 -0.40	77.300 3.0433	4.762 0.1875	0.8 0.03	39.5 1.56	40.0 1.57	69.0 2.72	23.4	8.8	0.0697	0.61 1.34
29.997 1.1810	23.812 0.9375	-10.2 -0.40	77.300 3.0433	4.762 0.1875	2.3 0.09	39.5 1.56	43.0 1.69	69.0 2.72	23.4	8.8	0.0697	0.61 1.34
29.997 1.1810	23.812 0.9375	-10.2 -0.40	77.300 3.0433	4.762 0.1875	3.5 0.14	39.5 1.56	45.5 1.79	69.0 2.72	23.4	8.8	0.0697	0.61 1.33
25.357 0.9983	19.050 0.7500	-8.6 -0.34	73.711 2.9020	3.962 0.1560	3.5 0.14	37.5 1.48	44.0 1.73	66.0 2.60	23.6	9.6	0.0656	0.46 1.02
25.357 0.9983	19.050 0.7500	-8.6 -0.34	73.711 2.9020	3.962 0.1560	0.8 0.03	37.5 1.48	38.5 1.52	66.0 2.60	23.6	9.6	0.0656	0.46 1.03
19.583 0.7710	15.875 0.6250	-4.3 -0.17	72.873 2.8690	3.962 0.1560	3.5 0.14	39.0 1.54	45.0 1.77	65.0 2.56	18.0	13.3	0.0668	0.35 0.79
22.225 0.8750	17.462 0.6875	-5.1 -0.20	72.128 2.8397	3.967 0.1562	0.8 0.03	38.5 1.52	39.0 1.54	65.0 2.56	17.5	8.5	0.0681	0.43 0.95
22.225 0.8750	17.462 0.6875	-5.1 -0.20	72.128 2.8397	3.967 0.1562	3.5 0.14	38.5 1.52	44.5 1.75	65.0 2.56	17.5	8.5	0.0681	0.43 0.94
19.050 0.7500	15.875 0.6250	-4.8 -0.19	67.366 2.6522	3.967 0.1562	3.5 0.14	38.0 1.50	44.0 1.73	60.0 2.36	14.6	10.0	0.0606	0.28 0.62
20.638 0.8125	15.875 0.6250	-5.8 -0.23	67.366 2.6522	3.967 0.1562	3.5 0.14	36.5 1.44	42.5 1.67	60.0 2.36	14.6	10.0	0.0606	0.30 0.65
16.764 0.6600	11.811 0.4650	-3.0 -0.12	61.912 2.4375	2.769 0.1090	2.3 0.09	36.0 1.42	40.0 1.57	57.0 2.24	12.8	9.7	0.0612	0.18 0.41
16.764 0.6600	11.811 0.4650	-3.0 -0.12	61.912 2.4375	2.769 0.1090	3.5 0.14	36.0 1.42	42.5 1.67	57.0 2.24	12.8	9.7	0.0612	0.18 0.39
16.764 0.6600	11.811 0.4650	-3.0 -0.12	61.722 2.4300	2.769 0.1090	3.5 0.14	36.0 1.42	42.5 1.67	57.0 2.24	12.8	9.7	0.0612	0.19 0.40

⁽⁴⁾Negative value indicates effective center inside cone (inner-ring) backface.

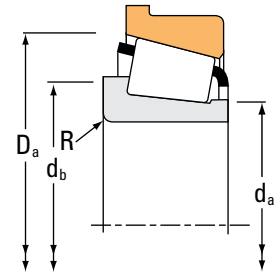
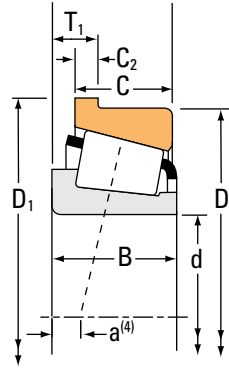
⁽⁵⁾These maximum fillet radii will be cleared by the bearing corners.

Continued on next page.

TAPERED ROLLER BEARINGS

SINGLE-ROW • TYPE TSF

TYPE TSF



Bearing Dimensions			Load Ratings							Part Number		
Bore d	O.D. D	Width T ₁	Dynamic ⁽¹⁾		Factors ⁽²⁾		Dynamic ⁽³⁾		Factors ⁽²⁾	Static C ₀	Inner	Outer
			C ₁	e	Y	C ₉₀	C _{a90}	K	N lbf			
mm in.	mm in.	mm in.	N lbf			N lbf	N lbf		N lbf			
31.750 1.2500	58.738 2.3125	6.736 0.2652	31700 7130	0.47	1.27	8220 1850	6670 1500	1.23	35000 7880	08125	08231-B	
32.004 1.2600	72.000 2.8346	7.087 0.2790	58800 13200	0.36	1.67	15200 3420	9390 2110	1.62	60100 13500	26126	26283-B	
33.337 1.3125	80.000 3.1496	7.938 0.3125	94300 21200	0.27	2.20	24400 5490	11400 2570	2.14	83400 18700	335-S	332-B	
33.337 1.3125	79.375 3.1250	10.320 0.4063	105000 23500	0.37	1.64	27100 6100	17000 3820	1.60	119000 26800	3477	3420-B	
33.337 1.3125	79.375 3.1250	10.320 0.4063	105000 23500	0.37	1.64	27100 6100	17000 3820	1.60	119000 26800	3483	3420-B	
33.337 1.3125	76.200 3.0000	11.112 0.4375	110000 24800	0.55	1.10	28600 6440	26800 6020	1.07	119000 26700	HM89443	HM89410-B	
33.337 1.3125	72.625 2.8593	11.112 0.4375	94800 21300	0.33	1.80	24600 5520	14000 3140	1.76	102000 22800	3197	3120-B	
33.337 1.3125	72.625 2.8593	11.112 0.4375	94800 21300	0.33	1.80	24600 5520	14000 3140	1.76	102000 22800	3196	3120-B	
33.337 1.3125	72.238 2.8440	8.733 0.3438	56600 12700	0.40	1.49	14700 3300	10100 2270	1.45	65800 14800	16131	16284-B	
33.337 1.3125	72.000 2.8346	7.087 0.2790	69600 15700	0.36	1.67	18100 4060	11100 2500	1.62	60100 13500	26131	26283-B	
33.337 1.3125	72.000 2.8346	7.087 0.2790	69600 15700	0.36	1.67	18100 4060	11100 2500	1.62	60100 13500	26132	26283-B	
33.337 1.3125	69.850 2.7500	8.725 0.3435	83700 18800	0.27	2.19	21700 4880	10200 2280	2.14	94400 21200	2581	2523-B	
33.337 1.3125	69.850 2.7500	8.733 0.3438	83700 18800	0.27	2.19	21700 4880	10200 2280	2.14	94400 21200	2585	2523-B	
33.338 1.3125	69.012 2.7170	7.938 0.3125	54600 12300	0.38	1.57	14200 3180	9260 2080	1.53	61700 13900	14131	14276-B	
33.338 1.3125	69.012 2.7170	7.938 0.3125	54600 12300	0.38	1.57	14200 3180	9260 2080	1.53	61700 13900	14130	14276-B	
34.925 1.3750	95.250 3.7500	11.115 0.4376	127000 28500	0.28	2.11	32900 7400	16000 3600	2.05	144000 32400	449	432-B	
34.925 1.3750	92.075 3.6250	11.115 0.4376	127000 28500	0.28	2.11	32900 7400	16000 3600	2.05	144000 32400	449	432AB	

⁽¹⁾Based on 1×10^6 revolutions L_{10} life, for the ISO life-calculation method.

⁽²⁾Consult your Timken engineer for instructions on use or review the Timken Engineering Manual on timken.com/catalogs.

⁽³⁾Based on 90×10^6 revolutions L_{10} life, for The Timken Company life-calculation method. C_{90} and C_{a90} are radial and thrust values.

Bearing Dimensions									Geometry Factors			Bearing Weight
Width B	Width C	Eff. Ctr. a ⁽⁴⁾	Outer Ring Flange O.D. D ₁	Flange Width C ₂	Shaft			Housing	G ₁	G ₂	C _g	
					Max Shaft Fillet Radius R ⁽⁵⁾	Backing Shoulder Dia.		Backing Shoulder Dia. D _a				
mm in.	mm in.	mm in.	mm in.	mm in.	mm in.	mm in.	mm in.	mm in.				kg lbs.
15.080 0.5937	10.716 0.4219	-1.3 -0.05	62.598 2.4645	2.769 0.1090	1.0 0.04	36.0 1.42	37.5 1.48	57.0 2.24	10.7	10.6	0.0601	0.17 0.38
18.923 0.7450	15.875 0.6250	-4.1 -0.16	75.857 2.9865	3.962 0.1560	1.5 0.06	37.5 1.48	39.5 1.56	66.0 2.60	16.1	10.1	0.0630	0.38 0.85
22.403 0.8820	17.826 0.7018	-6.4 -0.25	84.658 3.3330	4.762 0.1875	0.8 0.03	40.5 1.59	41.0 1.61	77.0 3.03	26.5	13.0	0.0676	0.57 1.26
29.771 1.1721	23.812 0.9375	-8.6 -0.34	84.049 3.3090	4.762 0.1875	3.5 0.14	42.5 1.67	49.0 1.93	76.0 2.99	29.9	11.2	0.0781	0.74 1.64
29.771 1.1721	23.812 0.9375	-8.6 -0.34	84.049 3.3090	4.762 0.1875	0.8 0.03	42.5 1.67	43.0 1.69	76.0 2.99	29.9	11.2	0.0781	0.75 1.65
28.575 1.1250	23.020 0.9063	-5.6 -0.22	80.863 3.1836	4.762 0.1875	0.8 0.03	44.5 1.75	46.5 1.83	75.0 2.95	28.9	9.9	0.0883	0.67 1.49
29.997 1.1810	23.812 0.9375	-10.2 -0.40	77.300 3.0433	4.762 0.1875	0.8 0.03	40.5 1.59	41.5 1.63	69.0 2.72	23.4	8.8	0.0697	0.59 1.30
29.997 1.1810	23.812 0.9375	-10.2 -0.40	77.300 3.0433	4.762 0.1875	3.5 0.14	40.5 1.59	47.0 1.85	69.0 2.72	23.4	8.8	0.0697	0.59 1.29
20.638 0.8125	15.875 0.6250	-4.1 -0.16	76.098 2.9960	3.970 0.1563	3.5 0.14	39.5 1.56	46.0 1.81	69.0 2.72	20.3	14.5	0.0707	0.41 0.91
18.923 0.7450	15.875 0.6250	-4.1 -0.16	75.857 2.9865	3.962 0.1560	3.5 0.14	38.5 1.52	44.5 1.75	66.0 2.60	16.1	10.1	0.0630	0.36 0.81
18.923 0.7450	15.875 0.6250	-4.1 -0.16	75.857 2.9865	3.962 0.1560	1.5 0.06	38.5 1.52	40.5 1.59	66.0 2.60	16.1	10.1	0.0630	0.37 0.82
25.357 0.9983	19.050 0.7500	-8.6 -0.34	73.711 2.9020	3.962 0.1560	0.8 0.03	39.0 1.54	39.5 1.56	66.0 2.60	23.6	9.6	0.0656	0.45 0.99
25.357 0.9983	19.050 0.7500	-8.6 -0.34	73.711 2.9020	3.962 0.1560	3.5 0.14	39.0 1.54	45.0 1.77	66.0 2.60	23.6	9.6	0.0656	0.45 0.98
19.583 0.7710	15.875 0.6250	-4.3 -0.17	72.873 2.8690	3.962 0.1560	0.8 0.03	40.0 1.57	41.0 1.61	65.0 2.56	18.0	13.3	0.0668	0.34 0.77
19.583 0.7710	15.875 0.6250	-4.3 -0.17	72.873 2.8690	3.962 0.1560	3.5 0.14	40.0 1.57	46.5 1.83	65.0 2.56	18.0	13.3	0.0668	0.34 0.78
29.900 1.1772	22.225 0.8750	-9.1 -0.36	100.686 3.9640	5.558 0.2188	0.8 0.03	43.5 1.71	44.0 1.73	87.0 3.43	42.5	11.3	0.0805	1.12 2.47
29.900 1.1772	22.225 0.8750	-9.1 -0.36	97.536 3.8400	5.558 0.2188	0.8 0.03	43.5 1.71	44.0 1.73	87.0 3.43	42.5	11.3	0.0805	1.03 2.28

⁽⁴⁾Negative value indicates effective center inside cone (inner-ring) backface.

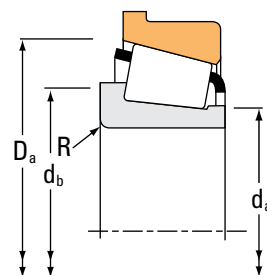
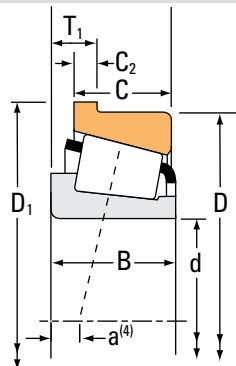
⁽⁵⁾These maximum fillet radii will be cleared by the bearing corners.

Continued on next page.

TAPERED ROLLER BEARINGS

SINGLE-ROW • TYPE TSF

TYPE TSF



Bearing Dimensions			Load Ratings							Part Number		
Bore d	O.D. D	Width T ₁	Dynamic ⁽¹⁾		Factors ⁽²⁾		Dynamic ⁽³⁾		Factors ⁽²⁾	Static C ₀	Inner	Outer
			C ₁	e	Y	C ₉₀	C _{a90}	K	C ₀			
mm in.	mm in.	mm in.	N lbf			N lbf	N lbf		N lbf			
34.925 1.3750	87.312 3.4375	11.112 0.4375	113000 25500	0.31	1.96	29400 6610	15400 3460	1.91	134000 30100		3581	3525-B
34.925 1.3750	81.755 3.2187	10.320 0.4063	115000 25800	0.27	2.20	29800 6700	13900 3130	2.14	129000 29100		3379	3329-B
34.925 1.3750	80.167 3.1562	10.320 0.4063	115000 25800	0.27	2.20	29800 6700	13900 3130	2.14	129000 29100		3379	3320-B
34.925 1.3750	80.000 3.1496	7.938 0.3125	79500 17900	0.27	2.20	20600 4640	9640 2170	2.14	83400 18700		343	332-B
34.925 1.3750	80.000 3.1496	7.938 0.3125	94300 21200	0.27	2.20	24400 5490	11400 2570	2.14	83400 18700		335	332-B
34.925 1.3750	80.000 3.1496	9.101 0.3583	75200 16900	0.40	1.49	19500 4390	13400 3020	1.45	68900 15500		28137	28315-B
34.925 1.3750	79.375 3.1250	10.320 0.4063	105000 23500	0.37	1.64	27100 6100	17000 3820	1.60	119000 26800		3478	3420-B
34.925 1.3750	79.375 3.1250	10.320 0.4063	105000 23500	0.37	1.64	27100 6100	17000 3820	1.60	119000 26800		3482	3420-B
34.925 1.3750	76.200 3.0000	10.320 0.4063	94700 21300	0.40	1.49	24600 5520	16900 3800	1.45	107000 24100		31593	31520-B
34.925 1.3750	76.200 3.0000	11.112 0.4375	86900 19500	0.30	1.98	22500 5060	11700 2630	1.93	102000 23000		2796	2720-B
34.925 1.3750	76.200 3.0000	11.112 0.4375	86900 19500	0.30	1.98	22500 5060	11700 2630	1.93	102000 23000		2786	2720-B
34.925 1.3750	76.200 3.0000	11.112 0.4375	86900 19500	0.30	1.98	22500 5060	11700 2630	1.93	102000 23000		2793	2720-B
34.925 1.3750	76.200 3.0000	11.112 0.4375	110000 24800	0.55	1.10	28600 6440	26800 6020	1.07	119000 26700	HM89446	HM89410-B	
34.925 1.3750	72.238 2.8440	8.733 0.3438	56600 12700	0.40	1.49	14700 3300	10100 2270	1.45	65800 14800		16137	16284-B
34.925 1.3750	69.012 2.7170	7.938 0.3125	54600 12300	0.38	1.57	14200 3180	9260 2080	1.53	61700 13900		14137A	14276-B
34.925 1.3750	69.012 2.7170	7.938 0.3125	54600 12300	0.38	1.57	14200 3180	9260 2080	1.53	61700 13900		14138A	14276-B
34.976 1.3770	80.000 3.1496	9.101 0.3583	63500 14300	0.40	1.49	16500 3700	11300 2550	1.45	68900 15500		28138	28315-B

⁽¹⁾Based on 1 x 10⁶ revolutions L₁₀ life, for the ISO life-calculation method.

⁽²⁾Consult your Timken engineer for instructions on use or review the Timken Engineering Manual on timken.com/catalogs.

⁽³⁾Based on 90 x 10⁶ revolutions L₁₀ life, for The Timken Company life-calculation method. C₉₀ and C_{a90} are radial and thrust values.

Bearing Dimensions									Geometry Factors			Bearing Weight
Width B	Width C	Eff. Ctr. a ⁽⁴⁾	Outer Ring Flange O.D. D ₁	Flange Width C ₂	Shaft			Housing	G ₁	G ₂	C _g	
					Max Shaft Fillet Radius R ⁽⁵⁾	Backing Shoulder Dia.		Backing Shoulder Dia. D _a				
mm in.	mm in.	mm in.	mm in.	mm in.	mm in.	mm in.	mm in.	mm in.				kg lbs.
30.886 1.2160	23.812 0.9375	-10.2 -0.40	91.986 3.6215	4.750 0.1870	3.5 0.14	43.0 1.69	49.5 1.95	82.0 3.23	39.5	12.5	0.0808	0.95 2.07
30.391 1.1965	23.812 0.9375	-10.9 -0.43	86.413 3.4021	4.762 0.1875	3.5 0.14	41.5 1.63	48.0 1.89	77.0 3.03	34.6	12.1	0.0744	0.79 1.76
30.391 1.1965	23.812 0.9375	-10.9 -0.43	84.826 3.3396	4.762 0.1875	3.5 0.14	41.5 1.63	48.0 1.89	77.0 3.03	34.6	12.1	0.0744	0.77 1.72
22.403 0.8820	17.826 0.7018	-6.4 -0.25	84.658 3.3330	4.762 0.1875	3.5 0.14	41.5 1.63	48.0 1.89	77.0 3.03	26.5	13.0	0.0676	0.55 1.21
22.403 0.8820	17.826 0.7018	-6.4 -0.25	84.658 3.3330	4.762 0.1875	0.8 0.03	41.5 1.63	42.5 1.67	77.0 3.03	26.5	13.0	0.0676	0.55 1.22
20.940 0.8244	15.875 0.6250	-4.8 -0.19	83.858 3.3015	3.970 0.1563	1.5 0.06	41.0 1.61	43.5 1.71	73.0 2.87	20.7	12.5	0.0709	0.50 1.12
29.771 1.1721	23.812 0.9375	-8.6 -0.34	84.049 3.3090	4.762 0.1875	3.5 0.14	43.5 1.71	50.0 1.97	76.0 2.99	29.9	11.2	0.0781	0.72 1.59
29.771 1.1721	23.812 0.9375	-8.6 -0.34	84.049 3.3090	4.762 0.1875	0.8 0.03	43.5 1.71	44.0 1.73	76.0 2.99	29.9	11.2	0.0781	0.73 1.61
28.575 1.1250	23.812 0.9375	-7.6 -0.30	80.863 3.1836	4.762 0.1875	3.5 0.14	43.5 1.71	50.0 1.97	74.0 2.91	26.3	9.1	0.0773	0.64 1.42
25.654 1.0100	19.050 0.7500	-8.1 -0.32	82.550 3.2500	6.350 0.2500	3.5 0.14	41.0 1.61	47.5 1.87	73.0 2.87	28.7	12.2	0.0725	0.59 1.29
25.654 1.0100	19.050 0.7500	-8.1 -0.32	82.550 3.2500	6.350 0.2500	5.0 0.20	41.0 1.61	51.0 2.01	73.0 2.87	28.7	12.2	0.0725	0.58 1.26
25.654 1.0100	19.050 0.7500	-8.1 -0.32	82.550 3.2500	6.350 0.2500	0.8 0.03	41.0 1.61	42.0 1.65	73.0 2.87	28.7	12.2	0.0725	0.59 1.29
28.575 1.1250	23.020 0.9063	-5.6 -0.22	80.863 3.1836	4.762 0.1875	3.5 0.14	44.5 1.75	56.0 2.20	75.0 2.95	28.9	9.9	0.0883	0.65 1.45
20.638 0.8125	15.875 0.6250	-4.1 -0.16	76.098 2.9960	3.970 0.1563	3.5 0.14	40.5 1.59	47.0 1.85	69.0 2.72	20.3	14.5	0.0707	0.40 0.88
19.583 0.7710	15.875 0.6250	-4.3 -0.17	72.873 2.8690	3.962 0.1560	1.5 0.06	41.5 1.63	43.5 1.71	65.0 2.56	18.0	13.3	0.0668	0.33 0.74
19.583 0.7710	15.875 0.6250	-4.3 -0.17	72.873 2.8690	3.962 0.1560	3.5 0.14	41.5 1.63	48.0 1.89	65.0 2.56	18.0	13.3	0.0668	0.33 0.74
20.940 0.8244	15.875 0.6250	-4.8 -0.19	83.858 3.3015	3.970 0.1563	1.5 0.06	41.0 1.61	43.5 1.71	73.0 2.87	20.7	12.5	0.0709	0.50 1.12

⁽⁴⁾Negative value indicates effective center inside cone (inner-ring) backface.

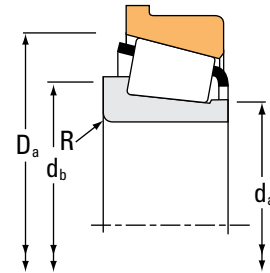
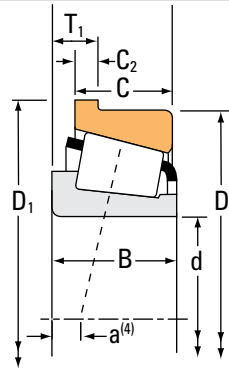
⁽⁵⁾These maximum fillet radii will be cleared by the bearing corners.

Continued on next page.

TAPERED ROLLER BEARINGS

SINGLE-ROW • TYPE TSF

TYPE TSF



Bearing Dimensions			Load Ratings							Part Number		
Bore d	O.D. D	Width T ₁	Dynamic ⁽¹⁾		Factors ⁽²⁾		Dynamic ⁽³⁾		Factors ⁽²⁾	Static C ₀	Inner	Outer
			C ₁	e	Y	C ₉₀	C _{a90}	K	C ₀			
mm in.	mm in.	mm in.	N lbf			N lbf	N lbf		N lbf			
34.976 1.3770	72.000 2.8346	6.286 0.2475	50700 11400	0.44	1.35	13100 2960	10000 2250	1.31	57800 13000		19138	19283-B
34.976 1.3770	69.012 2.7170	7.932 0.3123	54600 12300	0.38	1.57	14200 3180	9260 2080	1.53	61700 13900		14139	14276-B
35.000 1.3780	95.250 3.7500	11.115 0.4376	127000 28500	0.28	2.11	32900 7400	16000 3600	2.05	144000 32400		441	432-B
35.000 1.3780	92.075 3.6250	11.115 0.4376	127000 28500	0.28	2.11	32900 7400	16000 3600	2.05	144000 32400		441	432AB
35.000 1.3780	80.000 3.1496	7.938 0.3125	94300 21200	0.27	2.20	24400 5490	11400 2570	2.14	83400 18700		339	332-B
35.000 1.3780	80.000 3.1496	9.250 0.3642	87200 19600	0.31	1.90	22600 5080	12200 2740	1.85	86100 19300		X30307M	Y30307RM
35.000 1.3780	79.375 3.1250	10.320 0.4063	105000 23500	0.37	1.64	27100 6100	17000 3820	1.60	119000 26800		3480	3420-B
35.000 1.3780	72.000 2.8346	6.286 0.2475	50700 11400	0.44	1.35	13100 2960	10000 2250	1.31	57800 13000		19138X	19283-B
35.000 1.3780	68.262 2.6875	7.539 0.2968	50700 11400	0.44	1.35	13100 2960	10000 2250	1.31	57800 13000		19138X	19268-B
36.512 1.4375	88.500 3.4843	13.492 0.5312	99800 22400	0.78	0.77	25900 5810	34600 7770	0.75	88600 19900		44143	44348-B
36.512 1.4375	79.375 3.1250	10.320 0.4063	105000 23500	0.37	1.64	27100 6100	17000 3820	1.60	119000 26800		3479	3420-B
36.512 1.4375	76.200 3.0000	11.112 0.4375	110000 24800	0.55	1.10	28600 6440	26800 6020	1.07	119000 26700		HM89449	HM89410-B
36.512 1.4375	76.200 3.0000	11.112 0.4375	110000 24800	0.55	1.10	28600 6440	26800 6020	1.07	119000 26700		HM89448	HM89410-B
36.512 1.4375	72.238 2.8440	8.733 0.3438	56600 12700	0.40	1.49	14700 3300	10100 2270	1.45	65800 14800		16143	16284-B
36.512 1.4375	72.000 2.8346	6.286 0.2475	50700 11400	0.44	1.35	13100 2960	10000 2250	1.31	57800 13000		19143	19283-B
36.512 1.4375	68.262 2.6875	7.539 0.2968	50700 11400	0.44	1.35	13100 2960	10000 2250	1.31	57800 13000		19143	19268-B
38.100 1.5000	111.125 4.3750	14.288 0.5625	172000 38700	0.30	2.02	44600 10000	22700 5090	1.97	206000 46200		542	532-B

⁽¹⁾Based on 1 x 10⁶ revolutions L₁₀ life, for the ISO life-calculation method.

⁽²⁾Consult your Timken engineer for instructions on use or review the Timken Engineering Manual on timken.com/catalogs.

⁽³⁾Based on 90 x 10⁶ revolutions L₁₀ life, for The Timken Company life-calculation method. C₉₀ and C_{a90} are radial and thrust values.

Bearing Dimensions									Geometry Factors			Bearing Weight
Width B	Width C	Eff. Ctr. a ⁽⁴⁾	Outer Ring Flange O.D. D ₁	Flange Width C ₂	Shaft			Housing	G ₁	G ₂	C _g	
					Max Shaft Fillet Radius R ⁽⁵⁾	Backing Shoulder Dia. d _a	Backing Shoulder Dia. d _b	Backing Shoulder Dia. D _a				
mm in.	mm in.	mm in.	mm in.	mm in.	mm in.	mm in.	mm in.	mm in.				kg lbs.
16.520 0.6504	14.288 0.5625	-1.5 -0.06	75.857 2.9865	3.556 0.1400	1.5 0.06	40.5 1.59	42.5 1.67	68.0 2.68	17.5	11.5	0.0694	0.33 0.73
19.583 0.7710	15.875 0.6250	-4.3 -0.17	72.873 2.8690	3.962 0.1560	1.3 0.05	41.5 1.63	43.5 1.71	65.0 2.56	18.0	13.3	0.0668	0.33 0.74
29.900 1.1772	22.225 0.8750	-9.1 -0.36	100.686 3.9640	5.558 0.2188	3.5 0.14	43.5 1.71	50.0 1.97	87.0 3.43	42.5	11.3	0.0805	1.11 2.45
29.900 1.1772	22.225 0.8750	-9.1 -0.36	97.536 3.8400	5.558 0.2188	3.5 0.14	43.5 1.71	50.0 1.97	87.0 3.43	42.5	11.3	0.0805	1.02 2.27
22.403 0.8820	17.826 0.7018	-6.4 -0.25	84.658 3.3330	4.762 0.1875	0.8 0.03	41.5 1.63	42.5 1.67	77.0 3.03	26.5	13.0	0.0676	0.55 1.22
21.000 0.8268	18.000 0.7087	-5.8 -0.23	85.000 3.3464	4.500 0.1772	2.0 0.08	43.5 1.71	46.5 1.83	78.0 3.07	22.9	12.6	0.0675	0.55 1.21
29.771 1.1721	23.812 0.9375	-8.6 -0.34	84.049 3.3090	4.762 0.1875	1.5 0.06	43.5 1.71	46.0 1.81	76.0 2.99	29.9	11.2	0.0781	0.73 1.60
16.520 0.6504	14.288 0.5625	-1.5 -0.06	75.857 2.9865	3.556 0.1400	2.0 0.08	40.5 1.59	43.5 1.71	68.0 2.68	17.5	11.5	0.0694	0.33 0.73
16.520 0.6504	11.908 0.4688	-1.5 -0.06	72.128 2.8397	3.571 0.1406	2.0 0.08	40.5 1.59	43.5 1.71	67.0 2.64	17.5	11.5	0.0694	0.28 0.60
23.698 0.9330	17.462 0.6875	2.3 0.09	93.937 3.6983	5.555 0.2187	2.3 0.09	50.0 1.97	54.0 2.13	86.0 3.39	22.9	8.7	0.0899	0.77 1.68
29.771 1.1721	23.812 0.9375	-8.6 -0.34	84.049 3.3090	4.762 0.1875	0.8 0.03	44.5 1.75	45.5 1.79	76.0 2.99	29.9	11.2	0.0781	0.71 1.56
28.575 1.1250	23.020 0.9063	-5.6 -0.22	80.863 3.1836	4.762 0.1875	3.5 0.14	44.5 1.75	57.0 2.24	75.0 2.95	28.9	9.9	0.0883	0.63 1.41
28.575 1.1250	23.020 0.9063	-5.6 -0.22	80.863 3.1836	4.762 0.1875	0.8 0.03	44.5 1.75	48.5 1.91	75.0 2.95	28.9	9.9	0.0883	0.63 1.41
20.638 0.8125	15.875 0.6250	-4.1 -0.16	76.098 2.9960	3.970 0.1563	3.5 0.14	42.0 1.65	48.5 1.91	69.0 2.72	20.3	14.5	0.0707	0.38 0.84
16.520 0.6504	14.288 0.5625	-1.5 -0.06	75.857 2.9865	3.556 0.1400	1.5 0.06	41.5 1.63	44.0 1.73	68.0 2.68	17.5	11.5	0.0694	0.32 0.71
16.520 0.6504	11.908 0.4688	-1.5 -0.06	72.128 2.8397	3.571 0.1406	1.5 0.06	41.5 1.63	44.0 1.73	67.0 2.64	17.5	11.5	0.0694	0.27 0.58
36.957 1.4550	30.162 1.1875	-12.2 -0.48	117.373 4.6210	6.350 0.2500	3.5 0.14	49.0 1.93	55.0 2.17	100.0 3.94	64.3	16.1	0.0938	2.01 4.43

⁽⁴⁾Negative value indicates effective center inside cone (inner-ring) backface.

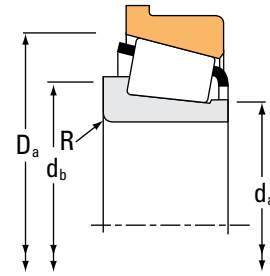
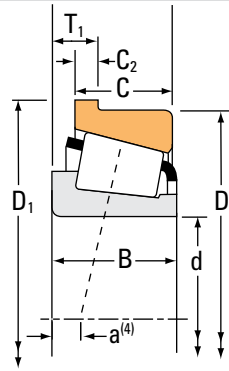
⁽⁵⁾These maximum fillet radii will be cleared by the bearing corners.

Continued on next page.

TAPERED ROLLER BEARINGS

SINGLE-ROW • TYPE TSF

TYPE TSF



Bearing Dimensions			Load Ratings							Part Number	
Bore d	O.D. D	Width T ₁	Dynamic ⁽¹⁾			Dynamic ⁽³⁾			Static C ₀	Inner	Outer
			C ₁	e	Y	C ₉₀	C _{a90}	K			
mm in.	mm in.	mm in.	N lbf			N lbf	N lbf		N lbf		
38.100 1.5000	95.250 3.7500	11.115 0.4376	127000 28500	0.28	2.11	32900 7400	16000 3600	2.05	144000 32400	440	432-B
38.100 1.5000	95.250 3.7500	11.115 0.4376	127000 28500	0.28	2.11	32900 7400	16000 3600	2.05	144000 32400	444	432-B
38.100 1.5000	92.075 3.6250	11.115 0.4376	127000 28500	0.28	2.11	32900 7400	16000 3600	2.05	144000 32400	440	432AB
38.100 1.5000	92.075 3.6250	11.115 0.4376	127000 28500	0.28	2.11	32900 7400	16000 3600	2.05	144000 32400	444	432AB
38.100 1.5000	88.500 3.4843	13.492 0.5312	99800 22400	0.78	0.77	25900 5810	34600 7770	0.75	88600 19900	44150	44348-B
38.100 1.5000	87.312 3.4375	11.112 0.4375	113000 25500	0.31	1.96	29400 6610	15400 3460	1.91	134000 30100	3580	3525-B
38.100 1.5000	87.312 3.4375	11.112 0.4375	113000 25500	0.31	1.96	29400 6610	15400 3460	1.91	134000 30100	3583	3525-B
38.100 1.5000	81.755 3.2187	10.320 0.4063	115000 25800	0.27	2.20	29800 6700	13900 3130	2.14	129000 29100	3381	3329-B
38.100 1.5000	81.755 3.2187	10.320 0.4063	115000 25800	0.27	2.20	29800 6700	13900 3130	2.14	129000 29100	3387	3329-B
38.100 1.5000	80.167 3.1562	10.320 0.4063	115000 25800	0.27	2.20	29800 6700	13900 3130	2.14	129000 29100	3381	3320-B
38.100 1.5000	80.167 3.1562	10.320 0.4063	115000 25800	0.27	2.20	29800 6700	13900 3130	2.14	129000 29100	3387	3320-B
38.100 1.5000	80.000 3.1496	7.938 0.3125	79500 17900	0.27	2.20	20600 4640	9640 2170	2.14	83400 18700	347	332-B
38.100 1.5000	80.000 3.1496	9.100 0.3583	75200 16900	0.40	1.49	19500 4390	13400 3020	1.45	68900 15500	28150	28315-B
38.100 1.5000	80.000 3.1496	9.101 0.3583	63500 14300	0.40	1.49	16500 3700	11300 2550	1.45	68900 15500	28151	28315-B
38.100 1.5000	79.375 3.1250	10.320 0.4063	105000 23500	0.37	1.64	27100 6100	17000 3820	1.60	119000 26800	3490	3420-B
38.100 1.5000	76.200 3.0000	11.112 0.4375	86900 19500	0.30	1.98	22500 5060	11700 2630	1.93	102000 23000	2788	2720-B
38.100 1.5000	72.238 2.8440	8.733 0.3438	56600 12700	0.40	1.49	14700 3300	10100 2270	1.45	65800 14800	16150	16284-B

⁽¹⁾Based on 1×10^6 revolutions L_{10} life, for the ISO life-calculation method.

⁽²⁾Consult your Timken engineer for instructions on use or review the Timken Engineering Manual on timken.com/catalogs.

⁽³⁾Based on 90×10^6 revolutions L_{10} life, for The Timken Company life-calculation method. C_{90} and C_{a90} are radial and thrust values.

Bearing Dimensions									Geometry Factors			Bearing Weight
Width B	Width C	Eff. Ctr. a ⁽⁴⁾	Outer Ring Flange O.D. D ₁	Flange Width C ₂	Shaft			Housing	G ₁	G ₂	C _g	
					Max Shaft Fillet Radius R ⁽⁵⁾	Backing Shoulder Dia.		Backing Shoulder Dia. D _a				
mm in.	mm in.	mm in.	mm in.	mm in.	mm in.	mm in.	mm in.	mm in.				kg lbs.
29.900 1.1772	22.225 0.8750	-9.1 -0.36	100.686 3.9640	5.558 0.2188	0.8 0.03	45.5 1.79	46.5 1.83	87.0 3.43	42.5	11.3	0.0805	1.08 2.37
29.900 1.1772	22.225 0.8750	-9.1 -0.36	100.686 3.9640	5.558 0.2188	3.5 0.14	45.5 1.79	52.0 2.05	87.0 3.43	42.5	11.3	0.0805	1.07 2.36
29.900 1.1772	22.225 0.8750	-9.1 -0.36	97.536 3.8400	5.558 0.2188	0.8 0.03	45.5 1.79	46.5 1.83	87.0 3.43	42.5	11.3	0.0805	0.99 2.19
29.900 1.1772	22.225 0.8750	-9.1 -0.36	97.536 3.8400	5.558 0.2188	3.5 0.14	45.5 1.79	52.0 2.05	87.0 3.43	42.5	11.3	0.0805	0.98 2.18
23.698 0.9330	17.462 0.6875	2.3 0.09	93.937 3.6983	5.555 0.2187	2.3 0.09	50.8 2.00	55.0 2.17	86.0 3.39	22.9	8.7	0.0899	0.75 1.64
30.886 1.2160	23.812 0.9375	-10.2 -0.40	91.986 3.6215	4.750 0.1870	1.5 0.06	45.5 1.79	48.0 1.89	82.0 3.23	39.5	12.5	0.0808	0.91 1.98
30.886 1.2160	23.812 0.9375	-10.2 -0.40	91.986 3.6215	4.750 0.1870	3.5 0.14	45.5 1.79	52.0 2.05	82.0 3.23	39.5	12.5	0.0808	0.90 1.97
30.391 1.1965	23.812 0.9375	-10.9 -0.43	86.413 3.4021	4.762 0.1875	3.5 0.14	44.5 1.75	51.0 2.01	77.0 3.03	34.6	12.1	0.0744	0.75 1.66
30.391 1.1965	23.812 0.9375	-10.9 -0.43	86.413 3.4021	4.762 0.1875	0.8 0.03	44.5 1.75	45.0 1.77	77.0 3.03	34.6	12.1	0.0744	0.75 1.67
30.391 1.1965	23.812 0.9375	-10.9 -0.43	84.826 3.3396	4.762 0.1875	3.5 0.14	44.5 1.75	51.0 2.01	77.0 3.03	34.6	12.1	0.0744	0.73 1.63
30.391 1.1965	23.812 0.9375	-10.9 -0.43	84.826 3.3396	4.762 0.1875	0.8 0.03	44.5 1.75	45.0 1.77	77.0 3.03	34.6	12.1	0.0744	0.73 1.63
22.403 0.8820	17.826 0.7018	-6.4 -0.25	84.658 3.3330	4.762 0.1875	3.5 0.14	44.0 1.73	50.0 1.97	77.0 3.03	26.5	13.0	0.0676	0.51 1.14
20.940 0.8244	15.875 0.6250	-4.8 -0.19	83.858 3.3015	3.970 0.1563	1.5 0.06	43.5 1.71	45.5 1.79	73.0 2.87	20.7	12.5	0.0709	0.47 1.05
20.940 0.8244	15.875 0.6250	-4.8 -0.19	83.858 3.3015	3.970 0.1563	3.5 0.14	43.5 1.71	50.0 1.97	73.0 2.87	20.7	12.5	0.0709	0.46 1.04
29.771 1.1721	23.812 0.9375	-8.6 -0.34	84.049 3.3090	4.762 0.1875	3.5 0.14	45.5 1.80	52.0 2.05	76.0 2.99	29.9	11.2	0.0781	0.68 1.50
25.654 1.0100	19.050 0.7500	-8.1 -0.32	82.550 3.2500	6.350 0.2500	3.5 0.14	43.5 1.71	50.0 1.97	73.0 2.87	28.7	12.2	0.0725	0.55 1.20
20.638 0.8125	15.875 0.6250	-4.1 -0.16	76.098 2.9960	3.970 0.1563	3.5 0.14	43.0 1.69	49.5 1.95	69.0 2.72	20.3	14.5	0.0707	0.37 0.81

⁽⁴⁾Negative value indicates effective center inside cone (inner-ring) backface.

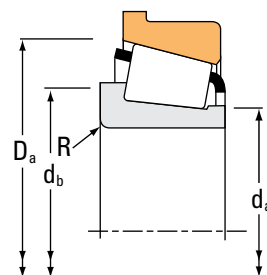
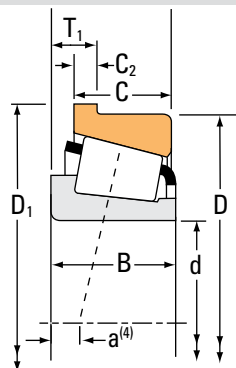
⁽⁵⁾These maximum fillet radii will be cleared by the bearing corners.

Continued on next page.

TAPERED ROLLER BEARINGS

SINGLE-ROW • TYPE TSF

TYPE TSF



Bearing Dimensions			Load Ratings							Part Number			
Bore d	O.D. D	Width T ₁	Dynamic ⁽¹⁾		Factors ⁽²⁾		Dynamic ⁽³⁾		Factors ⁽²⁾		Static C ₀	Inner	Outer
			C ₁	e	Y	C ₉₀	C _{a90}	K	N	N			
mm in.	mm in.	mm in.	N lbf			N lbf	N lbf		N lbf				
38.100 1.5000	72.000 2.8346	6.286 0.2475	50700 11400	0.44	1.35	13100 2960	10000 2250	1.31	57800 13000		19150	19283-B	
38.100 1.5000	68.262 2.6875	7.539 0.2968	50700 11400	0.44	1.35	13100 2960	10000 2250	1.31	57800 13000		19150	19268-B	
38.100 1.5000	65.088 2.5625	5.944 0.2340	27200 6100	0.35	1.73	7040 1580	4170 938	1.69	33000 7430		13889	13836-B	
38.481 1.5150	65.088 2.5625	5.944 0.2340	27200 6100	0.35	1.73	7040 1580	4170 938	1.69	33000 7430		13890	13836-B	
39.687 1.5625	120.650 4.7500	16.667 0.6562	207000 46600	0.31	1.91	53800 12100	28900 6510	1.86	244000 54800		620	612-B	
39.687 1.5625	88.500 3.4843	13.492 0.5312	99800 22400	0.78	0.77	25900 5810	34600 7770	0.75	88600 19900		44156	44348-B	
39.687 1.5625	88.500 3.4843	13.492 0.5312	99800 22400	0.78	0.77	25900 5810	34600 7770	0.75	88600 19900		44158	44348-B	
39.688 1.5625	81.755 3.2187	10.320 0.4063	115000 25800	0.27	2.20	29800 6700	13900 3130	2.14	129000 29100		3382	3329-B	
39.688 1.5625	81.755 3.2187	10.320 0.4063	115000 25800	0.27	2.20	29800 6700	13900 3130	2.14	129000 29100		3386	3329-B	
39.688 1.5625	80.167 3.1562	10.320 0.4063	115000 25800	0.27	2.20	29800 6700	13900 3130	2.14	129000 29100		3382	3320-B	
39.688 1.5625	80.167 3.1562	10.320 0.4063	115000 25800	0.27	2.20	29800 6700	13900 3130	2.14	129000 29100		3386	3320-B	
40.000 1.5748	95.250 3.7500	11.115 0.4376	127000 28500	0.28	2.11	32900 7400	16000 3600	2.05	144000 32400		442-S	432-B	
40.000 1.5748	95.000 3.7402	10.000 0.3937	154000 34600	0.41	1.45	39900 8960	28200 6350	1.41	166000 37300		XGA33210	YSA33210R	
40.000 1.5748	92.075 3.6250	11.115 0.4376	127000 28500	0.28	2.11	32900 7400	16000 3600	2.05	144000 32400		442-S	432AB	
40.000 1.5748	90.000 3.5433	10.250 0.4035	103000 23200	0.35	1.74	26800 6020	15800 3550	1.69	109000 24600		X30308UM	YSA30308RM	
40.000 1.5748	88.500 3.4843	13.492 0.5312	99800 22400	0.78	0.77	25900 5810	34600 7770	0.75	88600 19900		44157	44348-B	
40.000 1.5748	85.725 3.3750	11.112 0.4375	124000 27900	0.40	1.49	32200 7240	22200 4980	1.45	148000 33200		3879	3820-B	

⁽¹⁾Based on 1×10^6 revolutions L_{10} life, for the ISO life-calculation method.

⁽²⁾Consult your Timken engineer for instructions on use or review the Timken Engineering Manual on timken.com/catalogs.

⁽³⁾Based on 90×10^6 revolutions L_{10} life, for The Timken Company life-calculation method. C_{90} and C_{a90} are radial and thrust values.

Bearing Dimensions									Geometry Factors			Bearing Weight
Width B	Width C	Eff. Ctr. a ⁽⁴⁾	Outer Ring Flange O.D. D ₁	Flange Width C ₂	Shaft			Housing	G ₁	G ₂	C _g	
					Max Shaft Fillet Radius R ⁽⁵⁾	Backing Shoulder Dia. d _a	Backing Shoulder Dia. d _b	Backing Shoulder Dia. D _a				
mm in.	mm in.	mm in.	mm in.	mm in.	mm in.	mm in.	mm in.	mm in.				kg lbs.
16.520 0.6504	14.288 0.5625	-1.5 -0.06	75.857 2.9865	3.556 0.1400	1.5 0.06	43.0 1.69	45.0 1.77	68.0 2.68	17.5	11.5	0.0694	0.31 0.68
16.520 0.6504	11.908 0.4688	-1.5 -0.06	72.128 2.8397	3.571 0.1406	1.5 0.06	43.0 1.69	45.0 1.77	67.0 2.64	17.5	11.5	0.0694	0.26 0.55
11.908 0.4688	9.525 0.3750	-0.8 -0.03	68.161 2.6835	2.769 0.1090	1.5 0.06	42.5 1.67	45.0 1.77	63.0 2.48	14.8	23.3	0.0601	0.16 0.37
11.908 0.4688	9.525 0.3750	-0.8 -0.03	68.161 2.6835	2.769 0.1090	0.4 0.02	43.0 1.69	43.0 1.69	63.0 2.48	14.8	23.3	0.0601	0.16 0.36
41.275 1.6250	31.750 1.2500	-14.0 -0.55	127.691 5.0272	7.142 0.2812	0.8 0.03	52.0 2.05	53.0 2.09	110.0 4.33	75.9	16.2	0.0694	2.60 5.74
23.698 0.9330	17.462 0.6875	2.3 0.09	93.937 3.6983	5.555 0.2187	2.3 0.09	50.8 2.00	56.0 2.20	86.0 3.39	22.9	8.7	0.0899	0.73 1.60
23.698 0.9330	17.462 0.6875	2.3 0.09	93.937 3.6983	5.555 0.2187	3.5 0.14	50.8 2.00	58.0 2.28	86.0 3.39	22.9	8.7	0.0899	0.73 1.59
30.391 1.1965	23.812 0.9375	-10.9 -0.43	86.413 3.4021	4.762 0.1875	3.5 0.14	45.5 1.79	52.0 2.05	77.0 3.03	34.6	12.1	0.0744	0.73 1.61
30.391 1.1965	23.812 0.9375	-10.9 -0.43	86.413 3.4021	4.762 0.1875	0.8 0.03	45.5 1.79	46.5 1.83	77.0 3.03	34.6	12.1	0.0744	0.73 1.61
30.391 1.1965	23.812 0.9375	-10.9 -0.43	84.826 3.3396	4.762 0.1875	3.5 0.14	45.5 1.79	52.0 2.05	77.0 3.03	34.6	12.1	0.0744	0.71 1.58
30.391 1.1965	23.812 0.9375	-10.9 -0.43	84.826 3.3396	4.762 0.1875	0.8 0.03	45.5 1.79	46.5 1.83	77.0 3.03	34.6	12.1	0.0744	0.71 1.58
29.900 1.1772	22.225 0.8750	-9.1 -0.36	100.686 3.9640	5.558 0.2188	3.5 0.14	47.0 1.85	54.0 2.13	87.0 3.43	42.5	11.3	0.0805	1.04 2.30
32.000 1.2598	27.000 1.0630	-8.6 -0.34	102.000 4.0157	5.000 0.1968	1.5 0.06	54.0 2.13	56.0 2.20	89.0 3.50	48.4	16.9	0.0957	1.23 2.70
29.900 1.1772	22.225 0.8750	-9.1 -0.36	97.536 3.8400	5.558 0.2188	3.5 0.14	47.0 1.85	54.0 2.13	87.0 3.43	42.5	11.3	0.0805	0.95 2.12
23.000 0.9055	20.000 0.7874	-5.8 -0.23	96.000 3.7795	5.000 0.1969	2.0 0.08	50.0 1.97	53.0 2.09	85.0 3.35	31.6	15.4	0.0775	0.77 1.69
23.698 0.9330	17.462 0.6875	2.3 0.09	93.937 3.6983	5.555 0.2187	2.3 0.09	50.8 2.00	56.0 2.20	86.0 3.39	22.9	8.7	0.0899	0.73 1.59
30.162 1.1875	23.812 0.9375	-8.1 -0.32	89.586 3.5270	4.762 0.1875	0.8 0.03	50.0 1.97	51.0 2.01	83.0 3.27	37.8	13.5	0.0873	0.84 1.86

⁽⁴⁾Negative value indicates effective center inside cone (inner-ring) backface.

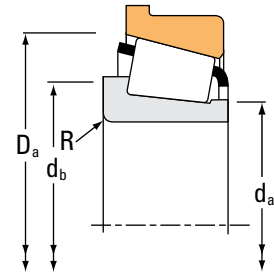
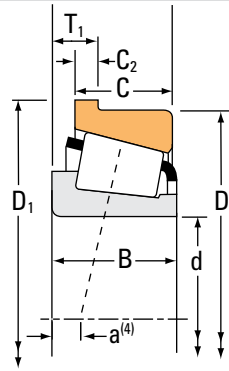
⁽⁵⁾These maximum fillet radii will be cleared by the bearing corners.

Continued on next page.

TAPERED ROLLER BEARINGS

SINGLE-ROW • TYPE TSF

TYPE TSF



Bearing Dimensions			Load Ratings							Part Number	
Bore d	O.D. D	Width T ₁	Dynamic ⁽¹⁾			Dynamic ⁽³⁾			Static C ₀	Inner	Outer
			C ₁	e	Y	C ₉₀	C _{a90}	K			
mm in.	mm in.	mm in.	N lbf			N lbf	N lbf		N lbf		
40.000 1.5748	80.000 3.1496	7.938 0.3125	94300 21200	0.27	2.20	24400 5490	11400 2570	2.14	83400 18700	344A	332-B
40.000 1.5748	80.000 3.1496	9.100 0.3583	75200 16900	0.40	1.49	19500 4390	13400 3020	1.45	68900 15500	28158	28315-B
41.275 1.6250	98.425 3.8750	16.670 0.6563	119000 26700	0.74	0.81	30800 6920	39000 8760	0.79	104000 23400	53162	53387-B
41.275 1.6250	95.250 3.7500	11.115 0.4376	127000 28500	0.28	2.11	32900 7400	16000 3600	2.05	144000 32400	447	432-B
41.275 1.6250	92.075 3.6250	11.115 0.4376	127000 28500	0.28	2.11	32900 7400	16000 3600	2.05	144000 32400	447	432AB
41.275 1.6250	88.500 3.4843	13.492 0.5312	99800 22400	0.78	0.77	25900 5810	34600 7770	0.75	88600 19900	44162	44348-B
41.275 1.6250	87.312 3.4375	11.099 0.4370	113000 25500	0.31	1.96	29400 6610	15400 3460	1.91	134000 30100	3585	3525-B
41.275 1.6250	87.312 3.4375	11.112 0.4375	113000 25500	0.31	1.96	29400 6610	15400 3460	1.91	134000 30100	3576	3525-B
41.275 1.6250	87.312 3.4375	11.112 0.4375	113000 25500	0.31	1.96	29400 6610	15400 3460	1.91	134000 30100	3577	3525-B
41.275 1.6250	85.725 3.3750	11.112 0.4375	124000 27900	0.40	1.49	32200 7240	22200 4980	1.45	148000 33200	3877	3820-B
41.275 1.6250	81.755 3.2187	10.320 0.4063	115000 25800	0.27	2.20	29800 6700	13900 3130	2.14	129000 29100	3383	3329-B
41.275 1.6250	80.167 3.1562	10.320 0.4063	115000 25800	0.27	2.20	29800 6700	13900 3130	2.14	129000 29100	3383	3320-B
41.275 1.6250	80.000 3.1496	7.938 0.3125	94300 21200	0.27	2.20	24400 5490	11400 2570	2.14	83400 18700	336	332-B
41.275 1.6250	80.000 3.1496	7.938 0.3125	94300 21200	0.27	2.20	24400 5490	11400 2570	2.14	83400 18700	342	332-B
41.275 1.6250	79.375 3.1250	8.732 0.3438	91100 20500	0.32	1.88	23600 5310	12900 2900	1.83	110000 24800	26882	26822-B
41.275 1.6250	76.200 3.0000	7.292 0.2871	48100 10800	0.49	1.23	12500 2800	10400 2340	1.20	55100 12400	11162	11300-B
42.850 1.6870	107.950 4.2500	11.112 0.4375	136000 30500	0.34	1.79	35200 7900	20200 4540	1.74	166000 37200	461	453-B

⁽¹⁾Based on 1 x 10⁶ revolutions L₁₀ life, for the ISO life-calculation method.

⁽²⁾Consult your Timken engineer for instructions on use or review the Timken Engineering Manual on timken.com/catalogs.

⁽³⁾Based on 90 x 10⁶ revolutions L₁₀ life, for The Timken Company life-calculation method. C₉₀ and C_{a90} are radial and thrust values.

Bearing Dimensions									Geometry Factors			Bearing Weight
Width B	Width C	Eff. Ctr. a ⁽⁴⁾	Outer Ring Flange O.D. D ₁	Flange Width C ₂	Shaft			Housing	G ₁	G ₂	C _g	
					Max Shaft Fillet Radius R ⁽⁵⁾	Backing Shoulder Dia.		Backing Shoulder Dia. D _a				
mm in.	mm in.	mm in.	mm in.	mm in.	mm in.	mm in.	mm in.	mm in.				kg lbs.
22.403 0.8820	17.826 0.7018	-6.4 -0.25	84.658 3.3330	4.762 0.1875	0.8 0.03	45.5 1.79	46.0 1.81	77.0 3.03	26.5	13.0	0.0676	0.50 1.11
20.940 0.8244	15.875 0.6250	-4.8 -0.19	83.858 3.3015	3.970 0.1563	1.5 0.06	45.0 1.77	47.5 1.87	73.0 2.87	20.7	12.5	0.0709	0.45 1.01
28.300 1.1142	20.638 0.8125	-0.3 -0.01	104.673 4.1210	6.350 0.2500	1.5 0.06	52.7 2.07	57.0 2.24	92.0 3.62	26.7	9.6	0.0930	1.10 2.44
29.900 1.1772	22.225 0.8750	-9.1 -0.36	100.686 3.9640	5.558 0.2188	3.5 0.14	48.5 1.91	55.0 2.17	87.0 3.43	42.5	11.3	0.0805	1.02 2.26
29.900 1.1772	22.225 0.8750	-9.1 -0.36	97.536 3.8400	5.558 0.2188	3.5 0.14	48.5 1.91	55.0 2.17	87.0 3.43	42.5	11.3	0.0805	0.93 2.07
23.698 0.9330	17.462 0.6875	2.3 0.09	93.937 3.6983	5.555 0.2187	2.3 0.09	50.8 2.00	57.0 2.24	86.0 3.39	22.9	8.7	0.0899	0.71 1.56
30.886 1.2160	23.812 0.9375	-10.2 -0.40	91.986 3.6215	4.750 0.1870	1.5 0.06	48.0 1.89	50.0 1.97	82.0 3.23	39.5	12.5	0.0808	0.86 1.88
30.886 1.2160	23.812 0.9375	-10.2 -0.40	91.986 3.6215	4.750 0.1870	0.8 0.03	48.0 1.89	49.0 1.93	82.0 3.23	39.5	12.5	0.0808	0.86 1.88
30.886 1.2160	23.812 0.9375	-10.2 -0.40	91.986 3.6215	4.750 0.1870	3.5 0.14	48.0 1.89	54.0 2.13	82.0 3.23	39.5	12.5	0.0808	0.85 1.87
30.162 1.1875	23.812 0.9375	-8.1 -0.32	89.586 3.5270	4.762 0.1875	3.5 0.14	50.0 1.98	57.0 2.24	83.0 3.27	37.8	13.5	0.0873	0.82 1.81
30.391 1.1965	23.812 0.9375	-10.9 -0.43	86.413 3.4021	4.762 0.1875	3.5 0.14	47.0 1.85	54.0 2.13	77.0 3.03	34.6	12.1	0.0744	0.70 1.55
30.391 1.1965	23.812 0.9375	-10.9 -0.43	84.826 3.3396	4.762 0.1875	3.5 0.14	47.0 1.85	54.0 2.13	77.0 3.03	34.6	12.1	0.0744	0.68 1.51
22.403 0.8820	17.826 0.7018	-6.4 -0.25	84.658 3.3330	4.762 0.1875	0.8 0.03	46.0 1.81	47.0 1.85	77.0 3.03	26.5	13.0	0.0676	0.49 1.08
22.403 0.8820	17.826 0.7018	-6.4 -0.25	84.658 3.3330	4.762 0.1875	3.5 0.14	46.0 1.81	53.0 2.09	77.0 3.03	26.5	13.0	0.0676	0.48 1.06
25.400 1.0000	19.050 0.7500	-7.4 -0.29	83.241 3.2772	3.970 0.1563	3.5 0.14	47.0 1.85	54.0 2.13	76.0 2.99	32.8	13.3	0.0770	0.55 1.21
17.384 0.6844	14.288 0.5625	-0.8 -0.03	80.863 3.1836	3.571 0.1406	1.5 0.06	46.5 1.83	49.0 1.93	73.0 2.87	19.2	16.0	0.0735	0.35 0.78
29.317 1.1542	22.225 0.8750	-7.1 -0.28	113.386 4.4640	5.558 0.2188	0.8 0.03	53.0 2.09	54.0 2.13	100.0 3.94	58.6	17.1	0.0946	1.40 3.08

⁽⁴⁾Negative value indicates effective center inside cone (inner-ring) backface.

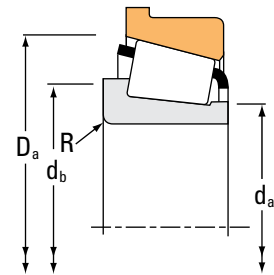
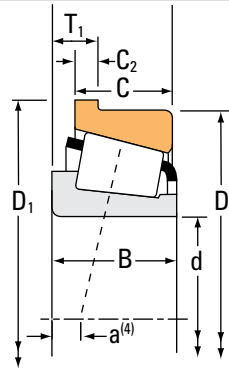
⁽⁵⁾These maximum fillet radii will be cleared by the bearing corners.

Continued on next page.

TAPERED ROLLER BEARINGS

SINGLE-ROW • TYPE TSF

TYPE TSF



Bearing Dimensions			Load Ratings							Part Number	
Bore d	O.D. D	Width T ₁	Dynamic ⁽¹⁾			Dynamic ⁽³⁾			Static C ₀	Inner	Outer
			C ₁	e	Y	C ₉₀	C _{a90}	K			
mm in.	mm in.	mm in.	N lbf			N lbf	N lbf		N lbf		
42.862 1.6875	87.312 3.4375	11.112 0.4375	113000 25500	0.31	1.96	29400 6610	15400 3460	1.91	134000 30100	3579	3525-B
42.862 1.6875	85.000 3.3465	9.525 0.3750	93300 21000	0.35	1.73	24200 5440	14300 3220	1.69	117000 26200	2973	2924-B
42.862 1.6875	83.058 3.2700	8.733 0.3438	90500 20300	0.33	1.79	23500 5270	13500 3020	1.74	111000 24900	25576	25521-B
42.875 1.6880	80.000 3.1496	7.938 0.3125	94300 21200	0.27	2.20	24400 5490	11400 2570	2.14	83400 18700	342-S	332-B
43.000 1.6929	80.000 3.1496	7.938 0.3125	94300 21200	0.27	2.20	24400 5490	11400 2570	2.14	83400 18700	342X	332-B
44.450 1.7500	127.000 5.0000	17.462 0.6875	306000 68800	0.30	2.01	79300 17800	40500 9110	1.96	370000 83300	6277	6220-B
44.450 1.7500	120.650 4.7500	16.574 0.6525	207000 46600	0.31	1.91	53800 12100	28900 6510	1.86	244000 54800	615	612-B
44.450 1.7500	108.966 4.2900	14.288 0.5625	202000 45500	0.40	1.49	52400 11800	36100 8110	1.45	202000 45400	59175	59429-B
44.450 1.7500	107.950 4.2500	11.115 0.4376	161000 36100	0.34	1.79	41700 9370	23900 5380	1.74	166000 37200	460	453-B
44.450 1.7500	101.600 4.0000	11.908 0.4688	157000 35400	0.40	1.50	40800 9170	28000 6290	1.46	155000 35000	49576	49520-B
44.450 1.7500	98.425 3.8750	16.670 0.6563	119000 26700	0.74	0.81	30800 6920	39000 8760	0.79	104000 23400	53176	53387-B
44.450 1.7500	95.250 3.7500	11.115 0.4376	127000 28500	0.28	2.11	32900 7400	16000 3600	2.05	144000 32400	435	432-B
44.450 1.7500	95.250 3.7500	11.115 0.4376	127000 28500	0.28	2.11	32900 7400	16000 3600	2.05	144000 32400	438	432-B
44.450 1.7500	92.075 3.6250	11.115 0.4376	127000 28500	0.28	2.11	32900 7400	16000 3600	2.05	144000 32400	435	432AB
44.450 1.7500	92.075 3.6250	11.115 0.4376	127000 28500	0.28	2.11	32900 7400	16000 3600	2.05	144000 32400	438	432AB
44.450 1.7500	87.312 3.4375	11.112 0.4375	113000 25500	0.31	1.96	29400 6610	15400 3460	1.91	134000 30100	3578	3525-B
44.450 1.7500	85.000 3.3465	7.938 0.3125	97000 21800	0.31	1.96	25100 5650	13200 2960	1.91	88800 20000	355	354-B

⁽¹⁾Based on 1×10^6 revolutions L_{10} life, for the ISO life-calculation method.

⁽²⁾Consult your Timken engineer for instructions on use or review the Timken Engineering Manual on timken.com/catalogs.

⁽³⁾Based on 90×10^6 revolutions L_{10} life, for The Timken Company life-calculation method. C_{90} and C_{a90} are radial and thrust values.

Bearing Dimensions									Geometry Factors			Bearing Weight
Width B	Width C	Eff. Ctr. a ⁽⁴⁾	Outer Ring Flange O.D. D ₁	Flange Width C ₂	Shaft			Housing	G ₁	G ₂	C _g	
					Max Shaft Fillet Radius R ⁽⁵⁾	Backing Shoulder Dia. d _a	Backing Shoulder Dia. d _b	Backing Shoulder Dia. D _a				
mm in.	mm in.	mm in.	mm in.	mm in.	mm in.	mm in.	mm in.	mm in.				kg lbs.
30.886 1.2160	23.812 0.9375	-10.2 -0.40	91.986 3.6215	4.750 0.1870	3.5 0.14	49.5 1.95	56.0 2.20	82.0 3.23	39.5	12.5	0.0808	0.83 1.81
25.608 1.0082	20.638 0.8125	-6.4 -0.25	89.764 3.5340	4.762 0.1875	3.5 0.14	49.5 1.95	56.0 2.20	82.0 3.23	38.2	15.7	0.0832	0.69 1.53
25.400 1.0000	19.050 0.7500	-6.4 -0.25	86.919 3.4220	3.970 0.1563	3.5 0.14	49.0 1.93	55.0 2.17	80.0 3.15	35.2	14.3	0.0801	0.60 1.32
22.403 0.8820	17.826 0.7018	-6.4 -0.25	84.658 3.3330	4.762 0.1875	3.5 0.14	47.5 1.87	54.0 2.13	77.0 3.03	26.5	13.0	0.0676	0.46 1.02
22.403 0.8820	17.826 0.7018	-6.1 -0.24	84.658 3.3330	4.762 0.1875	3.5 0.14	48.0 1.89	55.0 2.17	77.0 3.03	26.5	13.0	0.0676	0.46 1.03
52.388 2.0625	41.275 1.6250	-19.6 -0.77	134.925 5.3120	7.938 0.3125	3.5 0.14	60.0 2.36	67.0 2.64	117.0 4.61	103.1	18.7	0.0757	3.68 8.09
41.275 1.6250	31.750 1.2500	-14.0 -0.55	127.691 5.0272	7.142 0.2812	3.5 0.14	56.0 2.20	62.0 2.44	110.0 4.33	75.9	16.2	0.0694	2.49 5.50
36.512 1.4375	26.988 1.0625	-9.7 -0.38	115.214 4.5360	6.350 0.2500	3.5 0.14	56.0 2.20	63.0 2.48	101.0 3.98	57.3	15.2	0.0999	1.71 3.79
29.317 1.1542	22.225 0.8750	-7.1 -0.28	113.386 4.4640	5.558 0.2188	3.5 0.14	54.0 2.13	60.0 2.36	100.0 3.94	58.6	17.1	0.0946	1.37 3.01
31.750 1.2500	25.400 1.0000	-7.1 -0.28	107.056 4.2148	5.558 0.2188	0.8 0.03	54.0 2.13	55.0 2.17	98.0 3.86	49.1	16.8	0.0946	1.31 2.88
28.300 1.1142	20.638 0.8125	-0.3 -0.01	104.673 4.1210	6.350 0.2500	1.3 0.05	52.7 2.07	59.0 2.32	92.0 3.62	26.7	9.6	0.0930	1.05 2.33
29.900 1.1772	22.225 0.8750	-9.1 -0.36	100.686 3.9640	5.558 0.2188	0.8 0.03	51.0 2.01	52.0 2.05	87.0 3.43	42.5	11.3	0.0805	0.98 2.16
29.900 1.1772	22.225 0.8750	-9.1 -0.36	100.686 3.9640	5.558 0.2188	3.5 0.14	51.0 2.01	57.0 2.24	87.0 3.43	42.5	11.3	0.0805	0.97 2.15
29.900 1.1772	22.225 0.8750	-9.1 -0.36	97.536 3.8400	5.558 0.2188	0.8 0.03	51.0 2.01	52.0 2.05	87.0 3.43	42.5	11.3	0.0805	0.89 1.98
29.900 1.1772	22.225 0.8750	-9.1 -0.36	97.536 3.8400	5.558 0.2188	3.5 0.14	51.0 2.01	57.0 2.24	87.0 3.43	42.5	11.3	0.0805	0.88 1.96
30.886 1.2160	23.812 0.9375	-10.2 -0.40	91.986 3.6215	4.750 0.1870	3.5 0.14	51.0 2.01	57.0 2.24	82.0 3.23	39.5	12.5	0.0808	0.80 1.75
21.692 0.8540	17.462 0.6875	-4.8 -0.19	89.659 3.5299	4.762 0.1875	2.3 0.09	50.0 1.97	54.0 2.13	82.0 3.23	30.0	12.2	0.0732	0.54 1.19

⁽⁴⁾Negative value indicates effective center inside cone (inner-ring) backface.

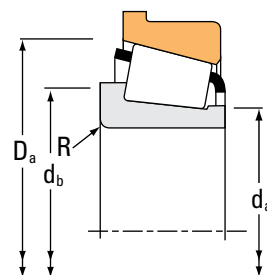
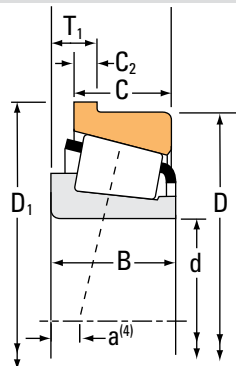
⁽⁵⁾These maximum fillet radii will be cleared by the bearing corners.

Continued on next page.

TAPERED ROLLER BEARINGS

SINGLE-ROW • TYPE TSF

TYPE TSF



Bearing Dimensions			Load Ratings							Part Number		
Bore d	O.D. D	Width T ₁	Dynamic ⁽¹⁾		Factors ⁽²⁾		Dynamic ⁽³⁾		Factors ⁽²⁾	Static C ₀	Inner	Outer
			C ₁	e	Y	C ₉₀	C _{a90}	K	C ₀			
mm in.	mm in.	mm in.	N lbf			N lbf	N lbf		N lbf			
44.450 1.7500	85.000 3.3465	7.938 0.3125	97000 21800	0.31	1.96	25100 5650	13200 2960	1.91	88800 20000		355X	354-B
44.450 1.7500	83.058 3.2700	8.733 0.3438	90500 20300	0.33	1.79	23500 5270	13500 3020	1.74	111000 24900		25580	25521-B
44.450 1.7500	79.375 3.1250	7.539 0.2968	52000 11700	0.37	1.60	13500 3030	8630 1940	1.56	61300 13800		18685	18620-B
44.450 1.7500	76.992 3.0312	9.126 0.3593	49500 11100	0.51	1.19	12800 2890	11100 2500	1.15	58100 13100		12175	12303-B
44.450 1.7500	73.025 2.8750	6.350 0.2500	57000 12800	0.32	1.88	14800 3320	8060 1810	1.83	78300 17600		L102849	L102810-B
44.450 1.7500	71.438 2.8125	5.969 0.2350	36100 8110	0.31	1.97	9350 2100	4890 1100	1.91	43600 9790		LL103049	LL103010-B
44.983 1.7710	93.264 3.6718	11.112 0.4375	122000 27500	0.34	1.77	31700 7120	18300 4120	1.73	153000 34300		3776	3720-B
44.983 1.7710	83.058 3.2700	8.733 0.3438	90500 20300	0.33	1.79	23500 5270	13500 3020	1.74	111000 24900		25584	25521-B
45.000 1.7717	100.000 3.9370	10.250 0.4035	129000 29000	0.35	1.74	33500 7530	19800 4450	1.69	139000 31300		X30309M	Y30309RM
45.000 1.7717	90.000 3.5433	8.887 0.3499	102000 22900	0.32	1.88	26400 5930	14400 3250	1.83	95800 21500		367	362-B
45.000 1.7717	85.000 3.3465	7.938 0.3125	97000 21800	0.31	1.96	25100 5650	13200 2960	1.91	88800 20000		358	354-B
45.000 1.7717	80.000 3.1496	10.000 0.3937	113000 25300	0.38	1.57	29200 6570	19200 4310	1.52	119000 26800		X33109	Y33109R
45.000 1.7717	75.000 2.9528	8.000 0.3150	78700 17700	0.39	1.53	20400 4590	13700 3080	1.49	84300 19000		X32009X	Y32009XR
45.237 1.7810	87.312 3.4375	11.112 0.4375	113000 25500	0.31	1.96	29400 6610	15400 3460	1.91	134000 30100		3586	3525-B
45.618 1.7960	83.058 3.2700	8.733 0.3438	90500 20300	0.33	1.79	23500 5270	13500 3020	1.74	111000 24900		25590	25521-B
46.037 1.8125	95.250 3.7500	11.115 0.4376	127000 28500	0.28	2.11	32900 7400	16000 3600	2.05	144000 32400		436	432-B
46.037 1.8125	92.075 3.6250	11.115 0.4376	127000 28500	0.28	2.11	32900 7400	16000 3600	2.05	144000 32400		436	432AB

⁽¹⁾Based on 1×10^6 revolutions L_{10} life, for the ISO life-calculation method.

⁽²⁾Consult your Timken engineer for instructions on use or review the Timken Engineering Manual on timken.com/catalogs.

⁽³⁾Based on 90×10^6 revolutions L_{10} life, for The Timken Company life-calculation method. C_{90} and C_{a90} are radial and thrust values.

Bearing Dimensions									Geometry Factors			Bearing Weight
Width B	Width C	Eff. Ctr. a ⁽⁴⁾	Outer Ring Flange O.D. D ₁	Flange Width C ₂	Shaft			Housing	G ₁	G ₂	C _g	
					Max Shaft Fillet Radius R ⁽⁵⁾	Backing Shoulder Dia.		Backing Shoulder Dia. D _a				
mm in.	mm in.	mm in.	mm in.	mm in.	mm in.	mm in.	mm in.	mm in.				kg lbs.
21.692 0.8540	17.462 0.6875	-4.8 -0.19	89.659 3.5299	4.762 0.1875	3.5 0.14	50.0 1.97	56.0 2.20	82.0 3.23	30.0	12.2	0.0732	0.53 1.18
25.400 1.0000	19.050 0.7500	-6.4 -0.25	86.919 3.4220	3.970 0.1563	3.5 0.14	50.0 1.97	57.0 2.24	80.0 3.15	35.2	14.3	0.0801	0.58 1.27
17.462 0.6875	13.495 0.5313	-2.0 -0.08	84.038 3.3086	3.571 0.1406	2.8 0.11	49.5 1.95	54.0 2.13	77.0 3.03	23.9	18.7	0.0725	0.36 0.81
17.145 0.6750	11.908 0.4688	0.0 0.00	80.564 3.1718	3.571 0.1406	1.5 0.06	49.5 1.95	52.0 2.05	75.0 2.95	21.0	17.5	0.0766	0.32 0.71
18.258 0.7188	15.083 0.5938	-3.8 -0.15	76.200 3.0000	3.175 0.1250	1.5 0.06	49.0 1.93	51.0 2.01	71.0 2.80	30.6	25.9	0.0751	0.31 0.68
12.700 0.5000	9.525 0.3750	-1.3 -0.05	74.232 2.9225	2.794 0.1100	1.5 0.06	48.5 1.91	51.0 2.01	69.0 2.72	20.0	23.6	0.0637	0.19 0.41
30.302 1.1930	23.812 0.9375	-8.1 -0.32	97.937 3.8558	4.762 0.1875	3.5 0.14	53.0 2.09	59.0 2.32	89.9 3.54	49.9	14.5	0.0903	0.99 2.16
25.400 1.0000	19.050 0.7500	-6.4 -0.25	86.919 3.4220	3.970 0.1563	1.5 0.06	51.0 2.01	53.0 2.09	80.0 3.15	35.2	14.3	0.0801	0.58 1.27
25.000 0.9843	22.000 0.8661	-6.1 -0.24	106.000 4.1732	5.000 0.1969	2.0 0.08	56.0 2.20	59.0 2.32	95.0 3.74	41.9	18.4	0.0851	1.05 2.31
22.225 0.8750	15.875 0.6250	-4.3 -0.17	94.661 3.7268	4.762 0.1875	2.0 0.08	51.0 2.01	55.0 2.17	86.0 3.39	33.8	14.0	0.0773	0.62 1.37
21.692 0.8540	17.462 0.6875	-4.8 -0.19	89.659 3.5299	4.762 0.1875	1.5 0.06	50.0 1.97	53.0 2.09	82.0 3.23	30.0	12.2	0.0732	0.53 1.18
26.000 1.0236	20.500 0.8071	-6.6 -0.26	85.000 3.3465	4.500 0.1772	1.5 0.06	52.0 2.05	55.0 2.17	79.0 3.11	35.7	16.5	0.0843	0.56 1.22
20.000 0.7874	15.500 0.6102	-3.3 -0.13	79.000 3.1102	3.500 0.1378	1.0 0.04	51.0 2.01	53.0 2.09	74.0 2.91	28.7	16.2	0.0788	0.36 0.79
30.886 1.2160	23.812 0.9375	-10.2 -0.40	91.986 3.6215	4.750 0.1870	3.5 0.14	52.0 2.05	58.0 2.28	82.0 3.23	39.5	12.5	0.0808	0.79 1.72
25.400 1.0000	19.050 0.7500	-6.4 -0.25	86.919 3.4220	3.970 0.1563	3.5 0.14	51.0 2.01	58.0 2.28	80.0 3.15	35.2	14.3	0.0801	0.56 1.23
29.900 1.1772	22.225 0.8750	-9.1 -0.36	100.686 3.9640	5.558 0.2188	3.5 0.14	52.0 2.05	59.0 2.32	87.0 3.43	42.5	11.3	0.0805	0.95 2.09
29.900 1.1772	22.225 0.8750	-9.1 -0.36	97.536 3.8400	5.558 0.2188	3.5 0.14	52.0 2.05	59.0 2.32	87.0 3.43	42.5	11.3	0.0805	0.86 1.90

⁽⁴⁾Negative value indicates effective center inside cone (inner-ring) backface.

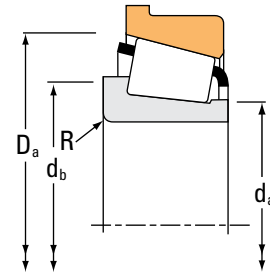
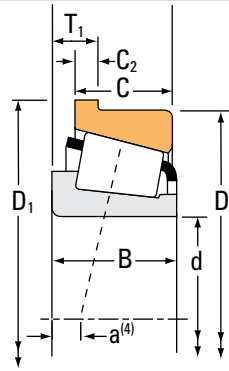
⁽⁵⁾These maximum fillet radii will be cleared by the bearing corners.

Continued on next page.

TAPERED ROLLER BEARINGS

SINGLE-ROW • TYPE TSF

TYPE TSF



Bearing Dimensions			Load Ratings							Part Number			
Bore d	O.D. D	Width T ₁	Dynamic ⁽¹⁾		Factors ⁽²⁾		Dynamic ⁽³⁾		Factors ⁽²⁾		Static C ₀	Inner	Outer
			C ₁	e	Y	C ₉₀	C _{a90}	K	N	N			
mm in.	mm in.	mm in.	N lbf			N lbf	N lbf			N lbf			
46.037 1.8125	85.000 3.3465	9.525 0.3750	93300 21000	0.35	1.73	24200 5440	14300 3220	1.69		117000 26200	2984	2924-B	
46.037 1.8125	79.375 3.1250	7.539 0.2968	52000 11700	0.37	1.60	13500 3030	8630 1940	1.56		61300 13800	18690	18620-B	
47.625 1.8750	120.650 4.7500	16.574 0.6525	207000 46600	0.31	1.91	53800 12100	28900 6510	1.86		244000 54800	617	612-B	
47.625 1.8750	108.966 4.2900	14.288 0.5625	202000 45500	0.40	1.49	52400 11800	36100 8110	1.45		202000 45400	59187	59429-B	
47.625 1.8750	107.950 4.2500	11.112 0.4375	136000 30500	0.34	1.79	35200 7900	20200 4540	1.74		166000 37200	463	453-B	
47.625 1.8750	107.950 4.2500	11.112 0.4375	161000 36100	0.34	1.79	41700 9370	23900 5380	1.74		166000 37200	467	453-B	
47.625 1.8750	95.250 3.7500	11.140 0.4386	147000 33100	0.55	1.10	38200 8590	35700 8030	1.07		157000 35400	HM804846	HM804811-B	
47.625 1.8750	93.264 3.6718	11.112 0.4375	122000 27500	0.34	1.77	31700 7120	18300 4120	1.73		153000 34300	3779	3720-B	
47.625 1.8750	93.264 3.6718	11.112 0.4375	122000 27500	0.34	1.77	31700 7120	18300 4120	1.73		153000 34300	3778	3720-B	
47.625 1.8750	90.000 3.5433	8.887 0.3499	102000 22900	0.32	1.88	26400 5930	14400 3250	1.83		95800 21500	369A	362-B	
47.625 1.8750	90.000 3.5433	8.887 0.3499	102000 22900	0.32	1.88	26400 5930	14400 3250	1.83		95800 21500	369-S	362-B	
47.625 1.8750	88.900 3.5000	8.887 0.3499	102000 22900	0.32	1.88	26400 5930	14400 3250	1.83		95800 21500	369-S	362AB	
49.212 1.9375	114.300 4.5000	16.670 0.6563	224000 50300	0.43	1.39	58000 13000	42700 9600	1.36		256000 57500	65390	65320-B	
49.212 1.9375	111.125 4.3750	14.288 0.5625	172000 38700	0.30	2.02	44600 10000	22700 5090	1.97		206000 46200	545	532-B	
49.212 1.9375	90.000 3.5433	8.887 0.3499	102000 22900	0.32	1.88	26400 5930	14400 3250	1.83		95800 21500	365-S	362-B	
49.982 1.9678	111.125 4.3750	14.288 0.5625	172000 38700	0.30	2.02	44600 10000	22700 5090	1.97		206000 46200	546	532-B	
49.987 1.9680	80.962 3.1875	7.145 0.2813	60800 13700	0.36	1.69	15800 3540	9590 2160	1.64		88800 20000	L305648	L305610-B	

⁽¹⁾Based on 1×10^6 revolutions L_{10} life, for the ISO life-calculation method.

⁽²⁾Consult your Timken engineer for instructions on use or review the Timken Engineering Manual on timken.com/catalogs.

⁽³⁾Based on 90×10^6 revolutions L_{10} life, for The Timken Company life-calculation method. C_{90} and C_{a90} are radial and thrust values.

Bearing Dimensions									Geometry Factors			Bearing Weight
Width B	Width C	Eff. Ctr. a ⁽⁴⁾	Outer Ring Flange O.D. D ₁	Flange Width C ₂	Shaft			Housing	G ₁	G ₂	C _g	
					Max Shaft Fillet Radius R ⁽⁵⁾	Backing Shoulder Dia. d _a	Backing Shoulder Dia. d _b	Backing Shoulder Dia. D _a				
mm in.	mm in.	mm in.	mm in.	mm in.	mm in.	mm in.	mm in.	mm in.				kg lbs.
25.608 1.0082	20.638 0.8125	-6.4 -0.25	89.764 3.5340	4.762 0.1875	3.5 0.14	52.0 2.05	58.0 2.28	82.0 3.23	38.2	15.7	0.0832	0.65 1.43
17.462 0.6875	13.495 0.5313	-2.0 -0.08	84.038 3.3086	3.571 0.1406	2.8 0.11	51.0 2.01	56.0 2.20	77.0 3.03	23.9	18.7	0.0725	0.34 0.77
41.275 1.6250	31.750 1.2500	-14.0 -0.55	127.691 5.0272	7.142 0.2812	3.5 0.14	58.0 2.28	65.0 2.56	110.0 4.33	75.9	16.2	0.0694	2.42 5.33
36.512 1.4375	26.988 1.0625	-9.7 -0.38	115.214 4.5360	6.350 0.2500	3.5 0.14	59.0 2.32	65.0 2.56	101.0 3.98	57.3	15.2	0.0999	1.65 3.64
29.317 1.1542	22.225 0.8750	-7.1 -0.28	113.386 4.4640	5.558 0.2188	4.8 0.19	56.0 2.20	65.0 2.56	100.0 3.94	58.6	17.1	0.0946	1.31 2.88
29.317 1.1542	22.225 0.8750	-7.1 -0.28	113.386 4.4640	5.558 0.2188	0.8 0.03	56.0 2.20	57.0 2.24	100.0 3.94	58.6	17.1	0.0946	1.32 2.91
29.370 1.1563	24.021 0.9457	-3.8 -0.15	100.686 3.9640	5.001 0.1969	3.5 0.14	57.0 2.26	66.0 2.60	93.0 3.66	44.8	13.8	0.1017	1.02 2.24
30.302 1.1930	23.812 0.9375	-8.1 -0.32	97.937 3.8558	4.762 0.1875	3.5 0.14	55.0 2.17	61.0 2.40	89.9 3.54	49.9	14.5	0.0903	0.94 2.06
30.302 1.1930	23.812 0.9375	-8.1 -0.32	97.937 3.8558	4.762 0.1875	6.4 0.25	55.0 2.17	67.0 2.64	89.9 3.54	49.9	14.5	0.0903	0.92 2.02
22.225 0.8750	15.875 0.6250	-4.3 -0.17	94.661 3.7268	4.762 0.1875	3.5 0.14	53.0 2.09	60.0 2.36	86.0 3.39	33.8	14.0	0.0773	0.59 1.29
22.225 0.8750	15.875 0.6250	-4.3 -0.17	94.661 3.7268	4.762 0.1875	2.3 0.09	53.0 2.09	57.0 2.24	86.0 3.39	33.8	14.0	0.0773	0.59 1.30
22.225 0.8750	16.513 0.6501	-4.3 -0.17	93.662 3.6875	4.762 0.1875	2.3 0.09	53.0 2.09	57.0 2.24	86.0 3.39	33.8	14.0	0.0773	0.58 1.28
44.450 1.7500	34.925 1.3750	-12.4 -0.49	121.341 4.7772	7.145 0.2813	3.5 0.14	60.0 2.36	70.0 2.76	107.0 4.21	63.1	13.0	0.1053	2.27 5.01
36.957 1.4550	30.162 1.1875	-12.2 -0.48	117.373 4.6210	6.350 0.2500	3.5 0.14	57.0 2.24	64.0 2.52	100.0 3.94	64.3	16.1	0.0938	1.78 3.94
22.225 0.8750	15.875 0.6250	-4.3 -0.17	94.661 3.7268	4.762 0.1875	0.8 0.03	54.0 2.13	55.0 2.17	86.0 3.39	33.8	14.0	0.0773	0.57 1.25
36.957 1.4550	30.162 1.1875	-12.2 -0.48	117.373 4.6210	6.350 0.2500	3.5 0.14	58.0 2.28	65.0 2.56	100.0 3.94	64.3	16.1	0.0938	1.77 3.90
18.258 0.7188	14.288 0.5625	-2.5 -0.10	84.036 3.3085	3.175 0.1250	1.5 0.06	55.0 2.17	57.0 2.24	78.0 3.07	38.8	29.8	0.0841	0.38 0.83

⁽⁴⁾Negative value indicates effective center inside cone (inner-ring) backface.

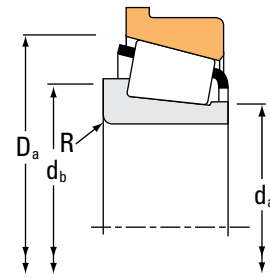
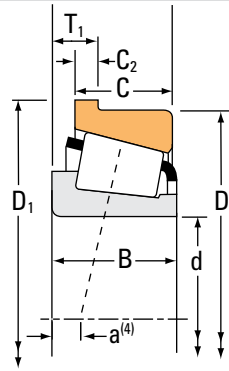
⁽⁵⁾These maximum fillet radii will be cleared by the bearing corners.

Continued on next page.

TAPERED ROLLER BEARINGS

SINGLE-ROW • TYPE TSF

TYPE TSF



Bearing Dimensions			Load Ratings							Part Number	
Bore d	O.D. D	Width T ₁	Dynamic ⁽¹⁾			Dynamic ⁽³⁾			Static C ₀	Inner	Outer
			C ₁	e	Y	C ₉₀	C _{a90}	K			
mm in.	mm in.	mm in.	N lbf			N lbf	N lbf		N lbf		
50.000 1.9685	110.000 4.3307	11.250 0.4429	149000 33400	0.35	1.74	38500 8660	22700 5110	1.69	160000 36000	X30310M	Y30310RM
50.000 1.9685	90.000 3.5433	8.887 0.3499	102000 22900	0.32	1.88	26400 5930	14400 3250	1.83	95800 21500	366	362-B
50.000 1.9685	90.000 3.5433	8.887 0.3499	102000 22900	0.32	1.88	26400 5930	14400 3250	1.83	95800 21500	365	362-B
50.800 2.0000	127.000 5.0000	16.670 0.6563	243000 54700	0.49	1.23	63100 14200	52700 11800	1.20	297000 66700	65200	65500-B
50.800 2.0000	120.650 4.7500	16.667 0.6562	207000 46600	0.31	1.91	53800 12100	28900 6510	1.86	244000 54800	619	612-B
50.800 2.0000	111.125 4.3750	15.083 0.5938	126000 28300	0.88	0.68	32700 7350	49500 11100	0.66	119000 26700	55200	55437-B
50.800 2.0000	107.950 4.2500	11.112 0.4375	161000 36100	0.34	1.79	41700 9370	23900 5380	1.74	166000 37200	455	453-B
50.800 2.0000	107.950 4.2500	11.115 0.4376	161000 36100	0.34	1.79	41700 9370	23900 5380	1.74	166000 37200	455-S	453-B
50.800 2.0000	104.775 4.1250	11.908 0.4688	153000 34500	0.33	1.80	39700 8930	22600 5090	1.76	189000 42600	45285	45220-B
50.800 2.0000	104.775 4.1250	11.908 0.4688	153000 34500	0.33	1.80	39700 8930	22600 5090	1.76	189000 42600	45285A	45220-B
50.800 2.0000	104.775 4.1250	11.908 0.4688	202000 45500	0.40	1.49	52400 11800	36100 8110	1.45	202000 45400	59201	59412-B
50.800 2.0000	104.775 4.1250	15.875 0.6250	203000 45700	0.49	1.23	52700 11900	44000 9890	1.20	223000 50200	HM807046	HM807010-B
50.800 2.0000	101.600 4.0000	11.908 0.4688	157000 35400	0.40	1.50	40800 9170	28000 6290	1.46	155000 35000	49585	49520-B
50.800 2.0000	93.264 3.6718	11.112 0.4375	122000 27500	0.34	1.77	31700 7120	18300 4120	1.73	153000 34300	3780	3720-B
50.800 2.0000	93.264 3.6718	11.112 0.4375	122000 27500	0.34	1.77	31700 7120	18300 4120	1.73	153000 34300	3775	3720-B
50.800 2.0000	92.075 3.6250	8.730 0.3437	98900 22200	0.38	1.59	25700 5770	16600 3720	1.55	130000 29200	28580	28521-B
50.800 2.0000	90.000 3.5433	8.888 0.3499	102000 22900	0.32	1.88	26400 5930	14400 3250	1.83	95800 21500	368	362-B

⁽¹⁾Based on 1 x 10⁶ revolutions L₁₀ life, for the ISO life-calculation method.

⁽²⁾Consult your Timken engineer for instructions on use or review the Timken Engineering Manual on timken.com/catalogs.

⁽³⁾Based on 90 x 10⁶ revolutions L₁₀ life, for The Timken Company life-calculation method. C₉₀ and C_{a90} are radial and thrust values.

Bearing Dimensions									Geometry Factors			Bearing Weight
Width B	Width C	Eff. Ctr. a ⁽⁴⁾	Outer Ring Flange O.D. D ₁	Flange Width C ₂	Shaft			Housing	G ₁	G ₂	C _g	
					Max Shaft Fillet Radius R ⁽⁵⁾	Backing Shoulder Dia.		Backing Shoulder Dia. D _a				
mm in.	mm in.	mm in.	mm in.	mm in.	mm in.	mm in.	mm in.	mm in.				kg lbs.
27.000 1.0630	23.000 0.9055	-6.1 -0.24	116.000 4.5669	5.000 0.1969	2.5 0.10	61.0 2.40	65.0 2.56	104.0 4.09	51.0	17.5	0.0907	1.30 2.87
22.225 0.8750	15.875 0.6250	-4.3 -0.17	94.661 3.7268	4.762 0.1875	2.3 0.09	55.0 2.17	59.0 2.32	86.0 3.39	33.8	14.0	0.0773	0.56 1.23
22.225 0.8750	15.875 0.6250	-4.3 -0.17	94.661 3.7268	4.762 0.1875	2.0 0.08	55.0 2.17	58.0 2.28	86.0 3.39	33.8	14.0	0.0773	0.56 1.23
44.450 1.7500	34.925 1.3750	-9.4 -0.37	134.041 5.2772	7.145 0.2813	3.5 0.14	69.0 2.72	75.0 2.95	120.0 4.72	83.2	17.2	0.0827	2.98 6.56
41.275 1.6250	31.750 1.2500	-14.0 -0.55	127.691 5.0272	7.142 0.2812	3.5 0.14	61.0 2.40	67.0 2.64	110.0 4.33	75.9	16.2	0.0694	2.34 5.16
26.909 1.0594	20.638 0.8125	7.1 0.28	116.683 4.5938	5.558 0.2188	3.5 0.14	63.9 2.51	71.0 2.80	107.0 4.21	36.8	13.2	0.1085	1.28 2.83
29.317 1.1542	22.225 0.8750	-7.1 -0.28	113.386 4.4640	5.558 0.2188	0.8 0.03	59.0 2.32	60.0 2.36	100.0 3.94	58.6	17.1	0.0946	1.27 2.78
29.317 1.1542	22.225 0.8750	-7.1 -0.28	113.386 4.4640	5.558 0.2188	3.5 0.14	59.0 2.32	65.0 2.56	100.0 3.94	58.6	17.1	0.0946	1.26 2.77
30.958 1.2188	23.812 0.9375	-8.1 -0.32	110.231 4.3398	5.558 0.2188	2.3 0.09	59.0 2.32	63.0 2.48	101.0 3.98	63.5	16.9	0.0971	1.26 2.77
30.958 1.2188	23.812 0.9375	-8.1 -0.32	110.231 4.3398	5.558 0.2188	0.8 0.03	59.0 2.32	60.0 2.36	101.0 3.98	63.5	16.9	0.0971	1.26 2.76
36.512 1.4375	28.575 1.1250	-9.7 -0.38	110.500 4.3504	3.970 0.1563	0.8 0.03	61.0 2.40	62.0 2.44	101.0 3.98	57.3	15.2	0.0999	1.45 3.19
36.512 1.4375	28.575 1.1250	-7.4 -0.29	114.300 4.5000	7.938 0.3125	3.5 0.14	63.1 2.48	70.0 2.76	103.0 4.06	63.9	17.1	0.0760	1.60 3.53
31.750 1.2500	25.400 1.0000	-7.1 -0.28	107.056 4.2148	5.558 0.2188	3.5 0.14	59.0 2.32	66.0 2.60	98.0 3.86	49.1	16.8	0.0946	1.18 2.61
30.302 1.1930	23.812 0.9375	-8.1 -0.32	97.937 3.8558	4.762 0.1875	3.5 0.14	58.0 2.28	64.0 2.52	89.9 3.54	49.9	14.5	0.0903	0.88 1.93
30.302 1.1930	23.812 0.9375	-8.1 -0.32	97.937 3.8558	4.762 0.1875	0.8 0.03	58.0 2.28	58.0 2.28	89.9 3.54	49.9	14.5	0.0903	0.89 1.95
25.400 1.0000	19.845 0.7813	-4.8 -0.19	95.941 3.7772	3.967 0.1562	3.5 0.14	57.0 2.24	63.0 2.48	89.0 3.50	46.4	18.9	0.0912	0.73 1.60
22.225 0.8750	15.875 0.6250	-4.3 -0.17	94.661 3.7268	4.762 0.1875	1.5 0.06	56.0 2.20	58.0 2.28	86.0 3.39	33.8	14.0	0.0773	0.54 1.20

⁽⁴⁾Negative value indicates effective center inside cone (inner-ring) backface.

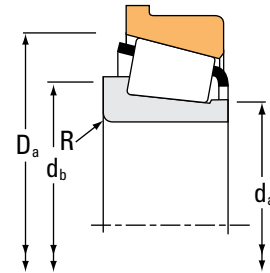
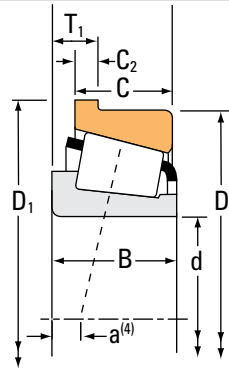
⁽⁵⁾These maximum fillet radii will be cleared by the bearing corners.

Continued on next page.

TAPERED ROLLER BEARINGS

SINGLE-ROW • TYPE TSF

TYPE TSF



Bearing Dimensions			Load Ratings							Part Number		
Bore d	O.D. D	Width T ₁	Dynamic ⁽¹⁾		Factors ⁽²⁾		Dynamic ⁽³⁾		Factors ⁽²⁾	Static	Inner	Outer
			C ₁	e	Y	C ₉₀	C _{a90}	K	C ₀			
mm in.	mm in.	mm in.	N lbf			N lbf	N lbf		N lbf			
50.800 2.0000	90.000 3.5433	8.888 0.3499	102000 22900	0.32	1.88	26400 5930	14400 3250	1.83	95800 21500		368A	362-B
50.800 2.0000	88.900 3.5000	8.887 0.3499	102000 22900	0.32	1.88	26400 5930	14400 3250	1.83	95800 21500		368A	362AB
50.800 2.0000	88.900 3.5000	8.888 0.3499	102000 22900	0.32	1.88	26400 5930	14400 3250	1.83	95800 21500		368	362AB
50.800 2.0000	85.725 3.3750	9.906 0.3900	61100 13700	0.57	1.06	15800 3560	15400 3470	1.03	63900 14400		18200	18337-B
50.800 2.0000	85.000 3.3465	7.539 0.2968	54700 12300	0.41	1.48	14200 3190	9840 2210	1.44	67500 15200		18790	18720-B
50.800 2.0000	80.962 3.1875	7.145 0.2813	60800 13700	0.36	1.69	15800 3540	9590 2160	1.64	88800 20000		L305649	L305610-B
50.800 2.0000	77.788 3.0625	5.969 0.2350	37300 8390	0.34	1.78	9680 2180	5570 1250	1.74	47200 10600		LL205449	LL205410-B
52.000 2.0472	85.725 3.3750	9.906 0.3900	51600 11600	0.57	1.06	13400 3010	13000 2920	1.03	63900 14400		18204X	18337-B
52.387 2.0625	111.125 4.3750	15.083 0.5938	126000 28300	0.88	0.68	32700 7350	49500 11100	0.66	119000 26700		55206	55437-B
52.387 2.0625	93.264 3.6718	11.112 0.4375	122000 27500	0.34	1.77	31700 7120	18300 4120	1.73	153000 34300		3767	3720-B
52.387 2.0625	92.075 3.6250	8.730 0.3437	98900 22200	0.38	1.59	25700 5770	16600 3720	1.55	130000 29200		28584	28521-B
53.975 2.1250	136.525 5.3750	16.662 0.6560	276000 62100	0.36	1.66	71600 16100	44400 9980	1.61	298000 67000		636	632-B
53.975 2.1250	127.000 5.0000	7.137 0.2810	226000 50800	0.35	1.73	58600 13200	34700 7810	1.69	248000 55700		557-S	553-BA
53.975 2.1250	127.000 5.0000	17.462 0.6875	306000 68800	0.30	2.01	79300 17800	40500 9110	1.96	370000 83300		6280	6220-B
53.975 2.1250	123.825 4.8750	14.288 0.5625	226000 50800	0.35	1.73	58600 13200	34700 7810	1.69	248000 55700		557-S	552-B
53.975 2.1250	120.650 4.7500	16.667 0.6562	207000 46600	0.31	1.91	53800 12100	28900 6510	1.86	244000 54800		621	612-B
53.975 2.1250	107.950 4.2500	11.115 0.4376	161000 36100	0.34	1.79	41700 9370	23900 5380	1.74	166000 37200		456	453-B

⁽¹⁾Based on 1×10^6 revolutions L_{10} life, for the ISO life-calculation method.

⁽²⁾Consult your Timken engineer for instructions on use or review the Timken Engineering Manual on timken.com/catalogs.

⁽³⁾Based on 90×10^6 revolutions L_{10} life, for The Timken Company life-calculation method. C_{90} and C_{a90} are radial and thrust values.

Bearing Dimensions									Geometry Factors			Bearing Weight
Width B	Width C	Eff. Ctr. a ⁽⁴⁾	Outer Ring Flange O.D. D ₁	Flange Width C ₂	Shaft			Housing	G ₁	G ₂	C _g	
					Max Shaft Fillet Radius R ⁽⁵⁾	Backing Shoulder Dia. d _a	Backing Shoulder Dia. d _b	Backing Shoulder Dia. D _a				
mm in.	mm in.	mm in.	mm in.	mm in.	mm in.	mm in.	mm in.	mm in.				kg lbs.
22.225 0.8750	15.875 0.6250	-4.3 -0.17	94.661 3.7268	4.762 0.1875	3.5 0.14	56.0 2.20	62.0 2.44	86.0 3.39	33.8	14.0	0.0773	0.54 1.19
22.225 0.8750	16.513 0.6501	-4.3 -0.17	93.662 3.6875	4.762 0.1875	3.5 0.14	56.0 2.20	62.0 2.44	86.0 3.39	33.8	14.0	0.0773	0.53 1.16
22.225 0.8750	16.513 0.6501	-4.3 -0.17	93.662 3.6875	4.762 0.1875	1.5 0.06	56.0 2.20	58.0 2.28	86.0 3.39	33.8	14.0	0.0773	0.53 1.18
18.263 0.7190	12.700 0.5000	2.0 0.08	89.586 3.5270	3.556 0.1400	1.5 0.06	56.0 2.20	59.0 2.32	83.0 3.27	26.1	22.1	0.0852	0.41 0.91
17.462 0.6875	13.495 0.5313	-0.8 -0.03	88.570 3.4870	3.571 0.1406	3.5 0.14	56.0 2.20	62.0 2.44	82.0 3.23	28.6	23.4	0.0789	0.40 0.89
18.258 0.7188	14.288 0.5625	-2.5 -0.10	84.036 3.3085	3.175 0.1250	1.5 0.06	56.0 2.20	58.0 2.28	78.0 3.07	38.8	29.8	0.0841	0.37 0.81
12.700 0.5000	9.525 0.3750	0.0 0.00	80.582 3.1725	2.794 0.1100	1.5 0.06	55.0 2.17	57.0 2.24	75.0 2.95	24.2	29.1	0.0699	0.21 0.46
18.263 0.7190	12.700 0.5000	2.0 0.08	89.586 3.5270	3.556 0.1400	2.0 0.08	57.0 2.24	60.0 2.36	83.0 3.27	26.1	22.1	0.0852	0.39 0.88
26.909 1.0594	20.638 0.8125	7.1 0.28	116.683 4.5938	5.558 0.2188	3.5 0.14	63.9 2.51	72.0 2.83	107.0 4.21	36.8	13.2	0.1085	1.26 2.77
30.302 1.1930	23.812 0.9375	-8.1 -0.32	97.937 3.8558	4.762 0.1875	2.3 0.09	59.0 2.32	63.0 2.48	89.9 3.54	49.9	14.5	0.0903	0.86 1.87
25.400 1.0000	19.845 0.7813	-4.8 -0.19	95.941 3.7772	3.967 0.1562	3.5 0.14	58.0 2.28	65.0 2.56	89.0 3.50	46.4	18.9	0.0912	0.69 1.52
41.275 1.6250	31.750 1.2500	-11.2 -0.44	143.561 5.6520	7.137 0.2810	3.5 0.14	67.0 2.64	73.0 2.87	125.0 4.92	106.4	21.0	0.0814	3.19 7.04
36.678 1.4440	34.925 1.3750	-9.4 -0.37	133.248 5.2460	6.350 0.2500	3.5 0.14	67.0 2.64	73.0 2.87	116.0 4.57	91.0	21.1	0.1108	2.46 5.40
52.388 2.0625	41.275 1.6250	-19.6 -0.77	134.925 5.3120	7.938 0.3125	3.5 0.14	67.0 2.64	74.0 2.91	117.0 4.61	103.1	18.7	0.0757	3.37 7.43
36.678 1.4440	30.162 1.1875	-9.4 -0.37	130.073 5.1210	6.350 0.2500	3.5 0.14	67.0 2.64	73.0 2.87	116.0 4.57	91.0	21.1	0.1108	2.31 5.08
41.275 1.6250	31.750 1.2500	-14.0 -0.55	127.691 5.0272	7.142 0.2812	3.5 0.14	63.0 2.48	70.0 2.76	110.0 4.33	75.9	16.2	0.0694	2.25 4.97
29.317 1.1542	22.225 0.8750	-7.1 -0.28	113.386 4.4640	5.558 0.2188	3.5 0.14	61.0 2.40	68.0 2.68	100.0 3.94	58.6	17.1	0.0946	1.20 2.63

⁽⁴⁾Negative value indicates effective center inside cone (inner-ring) backface.

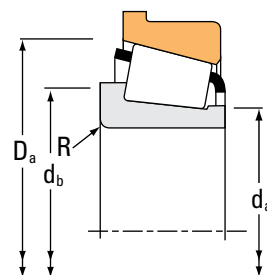
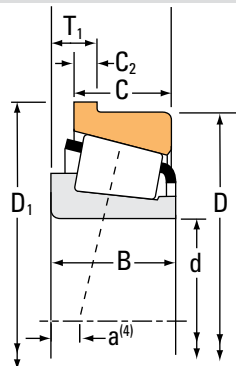
⁽⁵⁾These maximum fillet radii will be cleared by the bearing corners.

Continued on next page.

TAPERED ROLLER BEARINGS

SINGLE-ROW • TYPE TSF

TYPE TSF



Bearing Dimensions			Load Ratings							Part Number	
Bore d	O.D. D	Width T ₁	Dynamic ⁽¹⁾			Dynamic ⁽³⁾			Static C ₀	Inner	Outer
			C ₁	Factors ⁽²⁾ e Y		C ₉₀	Factors ⁽²⁾ K				
mm in.	mm in.	mm in.	N lbf			N lbf	N lbf		N lbf		
53.975 2.1250	93.264 3.6718	10.320 0.4063	130000 29200	0.33	1.82	33600 7560	19000 4270	1.77	161000 36200	33895	33820-B
54.813 2.1580	135.755 5.3447	17.462 0.6875	321000 72300	0.32	1.85	83300 18700	46300 10400	1.80	404000 90900	6380	6320-B
54.987 2.1649	135.755 5.3447	17.462 0.6875	321000 72300	0.32	1.85	83300 18700	46300 10400	1.80	404000 90900	6381	6320-B
55.000 2.1654	120.000 4.7244	11.095 0.4368	143000 32200	0.38	1.56	37200 8360	24500 5500	1.52	186000 41900	475	472-B
55.000 2.1654	120.000 4.7244	12.000 0.4724	174000 39100	0.35	1.74	45100 10100	26600 5990	1.69	190000 42700	X30311M	Y30311RM
55.000 2.1654	110.000 4.3307	16.000 0.6299	234000 52700	0.40	1.48	60700 13700	42000 9450	1.44	253000 56800	XGB-33212	Y33212R
55.000 2.1654	96.838 3.8125	7.938 0.3125	108000 24200	0.35	1.69	28000 6280	16900 3810	1.65	107000 24100	385	382-B
55.562 2.1875	107.950 4.2500	11.112 0.4375	161000 36100	0.34	1.79	41700 9370	23900 5380	1.74	166000 37200	466-S	453-B
55.575 2.1880	96.838 3.8125	7.938 0.3125	108000 24200	0.35	1.69	28000 6280	16900 3810	1.65	107000 24100	389	382-B
57.150 2.2500	149.225 5.8750	17.462 0.6875	411000 92400	0.36	1.66	107000 24000	66000 14800	1.61	463000 104000	6455	6420-B
57.150 2.2500	139.700 5.5000	17.462 0.6875	243000 54700	0.49	1.23	63100 14200	52700 11800	1.20	297000 66700	65225	65550-B
57.150 2.2500	136.525 5.3750	16.662 0.6560	233000 52400	0.36	1.66	60400 13600	37400 8420	1.61	298000 67000	635	632-B
57.150 2.2500	135.755 5.3447	17.462 0.6875	321000 72300	0.32	1.85	83300 18700	46300 10400	1.80	404000 90900	6375	6320-B
57.150 2.2500	123.825 4.8750	14.288 0.5625	226000 50800	0.35	1.73	58600 13200	34700 7810	1.69	248000 55700	555-S	552-B
57.150 2.2500	120.650 4.7500	16.667 0.6562	207000 46600	0.31	1.91	53800 12100	28900 6510	1.86	244000 54800	623	612-B
57.150 2.2500	112.712 4.4375	11.112 0.4375	139000 31200	0.40	1.49	36000 8090	24800 5570	1.45	191000 43000	3979	3920-B
57.150 2.2500	107.950 4.2500	11.115 0.4376	161000 36100	0.34	1.79	41700 9370	23900 5380	1.74	166000 37200	469	453-B

⁽¹⁾Based on 1 x 10⁶ revolutions L₁₀ life, for the ISO life-calculation method.

⁽²⁾Consult your Timken engineer for instructions on use or review the Timken Engineering Manual on timken.com/catalogs.

⁽³⁾Based on 90 x 10⁶ revolutions L₁₀ life, for The Timken Company life-calculation method. C₉₀ and C_{a90} are radial and thrust values.

Bearing Dimensions									Geometry Factors			Bearing Weight
Width B	Width C	Eff. Ctr. a ⁽⁴⁾	Outer Ring Flange O.D. D ₁	Flange Width C ₂	Shaft			Housing	G ₁	G ₂	C _g	
					Max Shaft Fillet Radius R ⁽⁵⁾	Backing Shoulder Dia. d _a	Backing Shoulder Dia. d _b	Backing Shoulder Dia. D _a				
mm in.	mm in.	mm in.	mm in.	mm in.	mm in.	mm in.	mm in.	mm in.				kg lbs.
28.575 1.1250	22.225 0.8750	-7.6 -0.30	97.937 3.8558	4.762 0.1875	1.5 0.06	60.0 2.36	63.0 2.48	91.0 3.58	52.5	18.5	0.0910	0.79 1.72
56.007 2.2050	44.450 1.7500	-19.3 -0.76	143.579 5.6527	7.938 0.3125	0.8 0.03	70.0 2.76	71.0 2.80	126.0 4.96	123.5	22.4	0.0827	4.18 9.23
56.007 2.2050	44.450 1.7500	-19.3 -0.76	143.579 5.6527	7.938 0.3125	3.5 0.14	70.0 2.76	76.0 2.99	126.0 4.96	123.5	22.4	0.0827	4.17 9.20
29.007 1.1420	24.237 0.9542	-4.1 -0.16	125.435 4.9384	5.537 0.2180	0.8 0.03	66.0 2.60	67.0 2.64	115.0 4.53	77.2	23.0	0.1083	1.70 3.74
29.000 1.1417	25.000 0.9843	-6.6 -0.26	127.000 5.0000	5.500 0.2165	2.5 0.10	70.0 2.76	71.0 2.80	113.0 4.45	62.8	24.0	0.0668	1.68 3.69
38.000 1.4961	29.000 1.1417	-9.9 -0.39	116.000 4.5669	7.000 0.2756	0.8 0.03	68.0 2.68	71.0 2.80	107.0 4.21	76.2	20.0	0.0758	1.72 3.80
21.946 0.8640	17.826 0.7018	-3.0 -0.12	101.498 3.9960	4.762 0.1875	2.3 0.09	61.0 2.40	65.0 2.56	94.0 3.70	42.0	15.7	0.0859	0.66 1.46
29.317 1.1542	22.225 0.8750	-7.1 -0.28	113.386 4.4640	5.558 0.2188	2.3 0.09	62.0 2.44	66.0 2.60	100.0 3.94	58.6	17.1	0.0946	1.17 2.58
21.946 0.8640	17.826 0.7018	-3.0 -0.12	101.498 3.9960	4.762 0.1875	2.3 0.09	61.0 2.40	65.0 2.56	94.0 3.70	42.0	15.7	0.0859	0.65 1.44
54.229 2.1350	44.450 1.7500	-15.0 -0.59	157.061 6.1835	7.938 0.3125	3.5 0.14	75.0 2.95	81.0 3.19	140.0 5.51	158.3	29.1	0.0931	5.21 11.50
44.450 1.7500	34.925 1.3750	-9.4 -0.37	152.400 6.0000	7.938 0.3125	3.5 0.14	71.0 2.79	80.0 3.15	120.0 4.72	83.2	17.2	0.0827	3.61 7.96
41.275 1.6250	31.750 1.2500	-11.2 -0.44	143.561 5.6520	7.137 0.2810	3.5 0.14	69.0 2.72	75.0 2.95	125.0 4.92	106.4	21.0	0.0814	3.10 6.84
56.007 2.2050	44.450 1.7500	-19.3 -0.76	143.579 5.6527	7.938 0.3125	4.3 0.17	72.0 2.83	80.0 3.15	126.0 4.96	123.5	22.4	0.0827	4.08 9.00
36.678 1.4440	30.162 1.1875	-9.4 -0.37	130.073 5.1210	6.350 0.2500	3.5 0.14	70.0 2.76	76.0 2.99	116.0 4.57	91.0	21.1	0.1108	2.23 4.90
41.275 1.6250	31.750 1.2500	-14.0 -0.55	127.691 5.0272	7.142 0.2812	3.5 0.14	66.0 2.60	72.0 2.83	110.0 4.33	75.9	16.2	0.0694	2.16 4.77
30.048 1.1830	23.812 0.9375	-4.6 -0.18	117.373 4.6210	4.762 0.1875	3.5 0.14	66.0 2.60	72.0 2.83	108.0 4.25	75.2	21.3	0.1092	1.40 3.10
29.317 1.1542	22.225 0.8750	-7.1 -0.28	113.386 4.4640	5.558 0.2188	3.5 0.14	68.0 2.68	72.0 2.83	100.0 3.94	58.6	17.1	0.0946	1.14 2.50

⁽⁴⁾Negative value indicates effective center inside cone (inner-ring) backface.

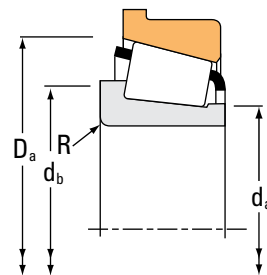
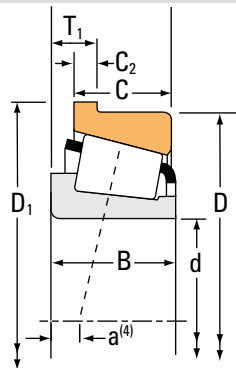
⁽⁵⁾These maximum fillet radii will be cleared by the bearing corners.

Continued on next page.

TAPERED ROLLER BEARINGS

SINGLE-ROW • TYPE TSF

TYPE TSF



Bearing Dimensions			Load Ratings							Part Number		
Bore d	O.D. D	Width T ₁	Dynamic ⁽¹⁾		Factors ⁽²⁾		Dynamic ⁽³⁾		Factors ⁽²⁾	Static	Inner	Outer
			C ₁	e	Y	C ₉₀	C _{a90}	K	C ₀			
mm in.	mm in.	mm in.	N lbf			N lbf	N lbf		N lbf			
57.150 2.2500	107.950 4.2500	11.115 0.4376	161000 36100	0.34	1.79	41700 9370	23900 5380	1.74	166000 37200		462	453-B
57.150 2.2500	104.775 4.1250	11.908 0.4688	153000 34500	0.33	1.80	39700 8930	22600 5090	1.76	189000 42600		45290	45220-B
57.150 2.2500	104.775 4.1250	11.908 0.4688	153000 34500	0.33	1.80	39700 8930	22600 5090	1.76	189000 42600		45291	45220-B
57.150 2.2500	97.630 3.8437	9.124 0.3592	123000 27700	0.40	1.49	32000 7180	22000 4950	1.45	142000 32000		28682	28622-B
57.150 2.2500	96.838 3.8125	7.938 0.3125	108000 24200	0.35	1.69	28000 6280	16900 3810	1.65	107000 24100		387	382-B
57.150 2.2500	96.838 3.8125	7.938 0.3125	108000 24200	0.35	1.69	28000 6280	16900 3810	1.65	107000 24100		387A	382-B
57.150 2.2500	87.312 3.4375	7.145 0.2813	62700 14100	0.39	1.54	16300 3650	10800 2430	1.50	95600 21500		L507949	L507910-B
57.150 2.2500	84.933 3.3438	5.969 0.2350	36100 8120	0.37	1.62	9370 2110	5940 1340	1.58	46800 10500		LL408049	LL408010-B
58.737 2.3125	112.712 4.4375	11.112 0.4375	139000 31200	0.40	1.49	36000 8090	24800 5570	1.45	191000 43000		3981	3920-B
59.931 2.3595	150.089 5.9090	15.875 0.6250	318000 71400	0.33	1.84	82400 18500	45900 10300	1.80	417000 93800		745	742-B
59.977 2.3613	100.000 3.9370	9.525 0.3750	106000 23800	0.43	1.41	27500 6180	20000 4500	1.37	149000 33500		28980	28921-B
59.987 2.3617	130.175 5.1250	16.637 0.6550	198000 44400	0.82	0.73	51200 11500	71900 16200	0.71	183000 41100		HM911244	HM911210-B
59.987 2.3617	129.944 5.1159	14.288 0.5625	191000 42900	0.35	1.73	49400 11100	29300 6590	1.69	248000 55700		558-S	553-SB
59.987 2.3617	104.775 4.1250	10.320 0.4063	115000 25800	0.39	1.55	29700 6680	19700 4440	1.51	120000 27000		39236	39412-B
60.000 2.3622	120.000 4.7244	11.095 0.4368	143000 32200	0.38	1.56	37200 8360	24500 5500	1.52	186000 41900		476	472-B
60.000 2.3622	112.712 4.4375	11.112 0.4375	139000 31200	0.40	1.49	36000 8090	24800 5570	1.45	191000 43000		3977	3920-B
60.000 2.3622	110.000 4.3307	10.320 0.4063	131000 29400	0.46	1.31	33800 7610	26600 5970	1.27	161000 36300		29580	29521-B

⁽¹⁾Based on 1 x 10⁶ revolutions L₁₀ life, for the ISO life-calculation method.

⁽²⁾Consult your Timken engineer for instructions on use or review the Timken Engineering Manual on timken.com/catalogs.

⁽³⁾Based on 90 x 10⁶ revolutions L₁₀ life, for The Timken Company life-calculation method. C₉₀ and C_{a90} are radial and thrust values.

Bearing Dimensions									Geometry Factors			Bearing Weight
Width B	Width C	Eff. Ctr. a ⁽⁴⁾	Outer Ring Flange O.D. D ₁	Flange Width C ₂	Shaft			Housing	G ₁	G ₂	C _g	
					Max Shaft Fillet Radius R ⁽⁵⁾	Backing Shoulder Dia. d _a	Backing Shoulder Dia. d _b	Backing Shoulder Dia. D _a				
mm in.	mm in.	mm in.	mm in.	mm in.	mm in.	mm in.	mm in.	mm in.				kg lbs.
29.317 1.1542	22.225 0.8750	-7.1 -0.28	113.386 4.4640	5.558 0.2188	2.3 0.09	63.0 2.48	67.0 2.64	100.0 3.94	58.6	17.1	0.0946	1.14 2.50
30.958 1.2188	23.812 0.9375	-8.1 -0.32	110.231 4.3398	5.558 0.2188	2.3 0.09	65.0 2.56	68.0 2.68	101.0 3.98	63.5	16.9	0.0971	1.13 2.48
30.958 1.2188	23.812 0.9375	-8.1 -0.32	110.231 4.3398	5.558 0.2188	6.4 0.25	65.0 2.56	76.0 2.99	101.0 3.98	63.5	16.9	0.0971	1.10 2.41
24.608 0.9688	19.446 0.7656	-3.3 -0.13	101.498 3.9960	3.962 0.1560	3.5 0.14	63.0 2.48	70.0 2.76	94.0 3.70	54.0	22.6	0.0979	0.75 1.66
21.946 0.8640	17.826 0.7018	-3.0 -0.12	101.498 3.9960	4.762 0.1875	2.3 0.09	63.0 2.48	67.0 2.64	94.0 3.70	42.0	15.7	0.0859	0.63 1.39
21.946 0.8640	17.826 0.7018	-3.0 -0.12	101.498 3.9960	4.762 0.1875	3.5 0.14	63.0 2.48	70.0 2.76	94.0 3.70	42.0	15.7	0.0859	0.63 1.38
18.258 0.7188	14.288 0.5625	-0.8 -0.03	90.488 3.5625	3.175 0.1250	1.5 0.06	62.0 2.44	65.0 2.56	85.0 3.35	46.1	38.5	0.0914	0.40 0.88
12.700 0.5000	9.525 0.3750	1.5 0.06	87.727 3.4538	2.794 0.1100	1.5 0.06	61.0 2.40	64.0 2.52	82.0 3.23	27.4	36.3	0.0749	0.24 0.52
30.048 1.1830	23.812 0.9375	-4.6 -0.18	117.373 4.6210	4.762 0.1875	3.5 0.14	67.0 2.64	73.0 2.87	108.0 4.25	75.2	21.3	0.1092	1.37 3.03
46.672 1.8375	36.512 1.4375	-11.9 -0.47	157.912 6.2170	7.938 0.3125	3.5 0.14	75.0 2.95	81.0 3.19	143.0 5.63	159.6	26.3	0.0898	4.40 9.69
25.400 1.0000	19.845 0.7813	-2.5 -0.10	103.962 4.0930	3.970 0.1563	3.5 0.14	67.0 2.64	73.0 2.87	98.0 3.86	60.1	24.5	0.1032	0.79 1.75
30.924 1.2175	23.812 0.9375	7.9 0.31	136.525 5.3750	6.350 0.2500	3.5 0.14	74.4 2.93	84.0 3.31	123.6 4.87	56.4	16.5	0.0842	2.09 4.60
36.678 1.4440	30.162 1.1875	-9.4 -0.37	136.025 5.3553	6.350 0.2500	3.5 0.14	69.0 2.72	75.0 2.95	116.0 4.57	91.0	21.1	0.1108	2.46 5.41
22.000 0.8661	15.875 0.6250	-1.5 -0.06	109.433 4.3084	4.762 0.1875	2.3 0.09	67.0 2.64	71.0 2.80	102.0 4.02	51.7	19.5	0.0947	0.77 1.70
29.007 1.1420	24.237 0.9542	-4.1 -0.16	125.435 4.9384	5.537 0.2180	2.0 0.08	69.0 2.72	73.0 2.87	115.0 4.53	77.2	23.0	0.1083	1.60 3.51
30.048 1.1830	23.812 0.9375	-4.6 -0.18	117.373 4.6210	4.762 0.1875	3.5 0.14	68.0 2.68	74.0 2.91	108.0 4.25	75.2	21.3	0.1092	1.34 2.97
25.400 1.0000	19.050 0.7500	-0.8 -0.03	113.800 4.4803	3.970 0.1563	3.5 0.14	68.0 2.68	75.0 2.95	105.0 4.13	70.3	25.9	0.1112	1.08 2.36

⁽⁴⁾Negative value indicates effective center inside cone (inner-ring) backface.

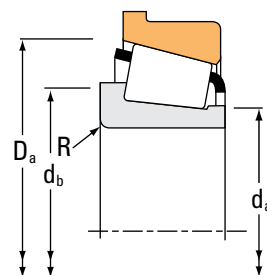
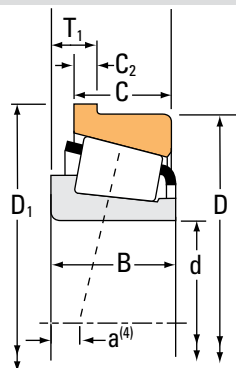
⁽⁵⁾These maximum fillet radii will be cleared by the bearing corners.

Continued on next page.

TAPERED ROLLER BEARINGS

SINGLE-ROW • TYPE TSF

TYPE TSF



Bearing Dimensions			Load Ratings							Part Number		
Bore d	O.D. D	Width T ₁	Dynamic ⁽¹⁾		Factors ⁽²⁾		Dynamic ⁽³⁾		Factors ⁽²⁾	Static	Inner	Outer
			C ₁	e	Y	C ₉₀	C _{a90}	K	C ₀			
mm in.	mm in.	mm in.	N lbf			N lbf	N lbf		N lbf			
60.000 2.3622	107.950 4.2500	10.320 0.4063	131000 29400	0.46	1.31	33800 7610	26600 5970	1.27	161000 36300		29580	29520-B
60.000 2.3622	100.000 3.9370	8.500 0.3346	82500 18500	0.47	1.27	21400 4810	17300 3890	1.24	101000 22800		JP6049	JP6010-B
60.325 2.3750	161.925 6.3750	23.012 0.9060	298000 66900	0.71	0.85	77100 17300	93600 21000	0.82	330000 74200		9275	9221-B
60.325 2.3750	136.525 5.3750	16.662 0.6560	233000 52400	0.36	1.66	60400 13600	37400 8420	1.61	298000 67000		637	632-B
60.325 2.3750	135.755 5.3447	17.462 0.6875	321000 72300	0.32	1.85	83300 18700	46300 10400	1.80	404000 90900		6376	6320-B
60.325 2.3750	130.175 5.1250	19.050 0.7500	198000 44400	0.82	0.73	51200 11500	71900 16200	0.71	183000 41100		HM911245	HM911210-B
60.325 2.3750	123.825 4.8750	14.288 0.5625	226000 50800	0.35	1.73	58600 13200	34700 7810	1.69	248000 55700		558	552-B
60.325 2.3750	112.712 4.4375	11.112 0.4375	139000 31200	0.40	1.49	36000 8090	24800 5570	1.45	191000 43000		3980	3920-B
60.325 2.3750	100.000 3.9370	9.525 0.3750	106000 23800	0.43	1.41	27500 6180	20000 4500	1.37	149000 33500		28985	28921-B
61.912 2.4375	130.175 5.1250	19.050 0.7500	198000 44400	0.82	0.73	51200 11500	71900 16200	0.71	183000 41100		HM911249	HM911210-B
61.912 2.4375	123.825 4.8750	14.288 0.5625	191000 42900	0.35	1.73	49400 11100	29300 6590	1.69	248000 55700		554	552-B
63.500 2.5000	149.225 5.8750	17.462 0.6875	411000 92400	0.36	1.66	107000 24000	66000 14800	1.61	463000 104000		6475	6420-B
63.500 2.5000	136.525 5.3750	16.637 0.6550	323000 72600	0.36	1.67	83700 18800	51600 11600	1.62	335000 75400		H414235	H414210-B
63.500 2.5000	136.525 5.3750	16.662 0.6560	276000 62100	0.36	1.66	71600 16100	44400 9980	1.61	298000 67000		639	632-B
63.500 2.5000	127.000 5.0000	14.288 0.5625	196000 44100	0.36	1.65	50900 11400	31700 7130	1.61	262000 58900		565	563-B
63.500 2.5000	123.825 4.8750	14.288 0.5625	226000 50800	0.35	1.73	58600 13200	34700 7810	1.69	248000 55700		559	552-B
63.500 2.5000	120.000 4.7244	11.095 0.4368	143000 32200	0.38	1.56	37200 8360	24500 5500	1.52	186000 41900		477	472-B

⁽¹⁾Based on 1×10^6 revolutions L_{10} life, for the ISO life-calculation method.

⁽²⁾Consult your Timken engineer for instructions on use or review the Timken Engineering Manual on timken.com/catalogs.

⁽³⁾Based on 90×10^6 revolutions L_{10} life, for The Timken Company life-calculation method. C_{90} and C_{a90} are radial and thrust values.

Bearing Dimensions									Geometry Factors			Bearing Weight
Width B	Width C	Eff. Ctr. a ⁽⁴⁾	Outer Ring Flange O.D. D ₁	Flange Width C ₂	Shaft			Housing	G ₁	G ₂	C _g	
					Max Shaft Fillet Radius R ⁽⁵⁾	Backing Shoulder Dia.		Backing Shoulder Dia. D _a				
mm in.	mm in.	mm in.	mm in.	mm in.	mm in.	mm in.	mm in.	mm in.				kg lbs.
25.400 1.0000	19.050 0.7500	-0.8 -0.03	111.816 4.4022	3.970 0.1563	3.5 0.14	68.0 2.68	75.0 2.95	105.0 4.13	70.3	25.9	0.1112	1.02 2.25
20.000 0.7874	15.500 0.6102	1.3 0.05	105.000 4.1339	3.000 0.1181	2.0 0.08	66.0 2.60	69.0 2.72	98.0 3.86	39.5	22.5	0.0922	0.62 1.37
46.038 1.8125	30.162 1.1875	1.8 0.07	171.450 6.7500	7.137 0.2810	3.5 0.14	89.0 3.50	102.0 4.02	153.0 6.03	102.5	16.1	0.0984	4.83 10.65
41.275 1.6250	31.750 1.2500	-11.2 -0.44	143.561 5.6520	7.137 0.2810	3.5 0.14	72.0 2.83	78.0 3.07	125.0 4.92	106.4	21.0	0.0814	3.01 6.63
56.007 2.2050	44.450 1.7500	-19.3 -0.76	143.579 5.6527	7.938 0.3125	3.5 0.14	74.0 2.91	81.0 3.19	126.0 4.96	123.5	22.4	0.0827	3.95 8.73
33.338 1.3125	23.812 0.9375	5.3 0.21	136.525 5.3750	6.350 0.2500	5.0 0.20	74.0 2.91	93.0 3.66	123.6 4.87	56.4	16.5	0.0842	2.16 4.75
36.678 1.4440	30.162 1.1875	-9.4 -0.37	130.073 5.1210	6.350 0.2500	2.3 0.09	72.0 2.83	76.0 2.99	116.0 4.57	91.0	21.1	0.1108	2.15 4.72
30.048 1.1830	23.812 0.9375	-4.6 -0.18	117.373 4.6210	4.762 0.1875	3.5 0.14	68.0 2.68	75.0 2.95	108.0 4.25	75.2	21.3	0.1092	1.33 2.95
25.400 1.0000	19.845 0.7813	-2.5 -0.10	103.962 4.0930	3.970 0.1563	3.5 0.14	67.0 2.64	73.0 2.87	98.0 3.86	60.1	24.5	0.1032	0.78 1.73
33.338 1.3125	23.812 0.9375	5.3 0.21	136.525 5.3750	6.350 0.2500	3.5 0.14	74.0 2.91	91.0 3.58	123.6 4.87	56.4	16.5	0.0842	2.13 4.69
36.678 1.4440	30.162 1.1875	-9.4 -0.37	130.073 5.1210	6.350 0.2500	3.5 0.14	71.0 2.80	77.0 3.03	116.0 4.57	91.0	21.1	0.1108	2.09 4.61
54.229 2.1350	44.450 1.7500	-15.0 -0.59	157.061 6.1835	7.938 0.3125	3.5 0.14	80.0 3.15	86.0 3.39	140.0 5.51	158.3	29.1	0.0931	4.96 10.93
41.275 1.6250	31.750 1.2500	-10.9 -0.43	143.637 5.6550	7.112 0.2800	3.5 0.14	78.0 3.07	82.0 3.23	130.0 5.12	112.8	22.9	0.0827	2.94 6.47
41.275 1.6250	31.750 1.2500	-11.2 -0.44	143.561 5.6520	7.137 0.2810	3.5 0.14	74.0 2.91	81.0 3.19	125.0 4.92	106.4	21.0	0.0814	2.91 6.41
36.170 1.4240	28.575 1.1250	-8.1 -0.32	133.248 5.2460	6.350 0.2500	3.5 0.14	73.0 2.87	80.0 3.15	121.0 4.76	101.3	24.0	0.1167	2.16 4.76
36.678 1.4440	30.162 1.1875	-9.4 -0.37	130.073 5.1210	6.350 0.2500	3.5 0.14	75.0 2.95	81.0 3.19	116.0 4.57	91.0	21.1	0.1108	2.05 4.52
29.007 1.1420	24.237 0.9542	-4.1 -0.16	125.435 4.9384	5.537 0.2180	0.8 0.03	72.0 2.83	73.0 2.87	115.0 4.53	77.2	23.0	0.1083	1.52 3.35

⁽⁴⁾Negative value indicates effective center inside cone (inner-ring) backface.

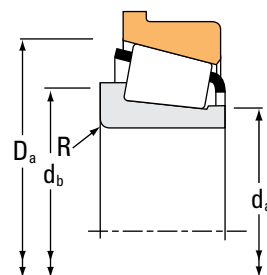
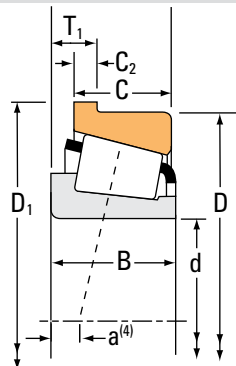
⁽⁵⁾These maximum fillet radii will be cleared by the bearing corners.

Continued on next page.

TAPERED ROLLER BEARINGS

SINGLE-ROW • TYPE TSF

TYPE TSF



Bearing Dimensions			Load Ratings							Part Number	
Bore d	O.D. D	Width T ₁	Dynamic ⁽¹⁾			Dynamic ⁽³⁾			Static C ₀	Inner	Outer
			C ₁	e	Y	C ₉₀	C _{a90}	K			
mm in.	mm in.	mm in.	N lbf			N lbf	N lbf		N lbf		
63.500 2.5000	120.000 4.7244	11.095 0.4368	143000 32200	0.38	1.56	37200 8360	24500 5500	1.52	186000 41900	483	472-B
63.500 2.5000	112.712 4.4375	7.917 0.3117	98900 22200	0.40	1.49	25600 5760	17600 3970	1.45	125000 28100	395	3920-B
63.500 2.5000	112.712 4.4375	11.112 0.4375	139000 31200	0.40	1.49	36000 8090	24800 5570	1.45	191000 43000	3982	3920-B
63.500 2.5000	107.950 4.2500	10.320 0.4063	131000 29400	0.46	1.31	33800 7610	26600 5970	1.27	161000 36300	29585	29520-B
63.500 2.5000	104.775 4.1250	10.320 0.4063	115000 25800	0.39	1.55	29700 6680	19700 4440	1.51	120000 27000	39250	39412-B
64.960 2.5575	149.225 5.8750	17.462 0.6875	411000 92400	0.36	1.66	107000 24000	66000 14800	1.61	463000 104000	6464	6420-B
64.963 2.5576	127.000 5.0000	14.288 0.5625	196000 44100	0.36	1.65	50900 11400	31700 7130	1.61	262000 58900	569	563-B
65.000 2.5591	120.000 4.7244	11.095 0.4368	143000 32200	0.38	1.56	37200 8360	24500 5500	1.52	186000 41900	478	472-B
65.087 2.5625	135.755 5.3447	17.462 0.6875	381000 85600	0.32	1.85	98800 22200	54900 12300	1.80	404000 90900	6379	6320-B
65.883 2.5938	122.238 4.8125	13.495 0.5313	280000 63000	0.36	1.67	72700 16300	44600 10000	1.63	327000 73500	5595	5535-B
66.675 2.6250	139.700 5.5000	17.462 0.6875	319000 71700	0.47	1.27	82700 18600	67000 15100	1.24	405000 91000	H715341	H715310-B
66.675 2.6250	136.525 5.3750	16.662 0.6560	276000 62100	0.36	1.66	71600 16100	44400 9980	1.61	298000 67000	641	632-B
66.675 2.6250	135.755 5.3447	17.462 0.6875	321000 72300	0.32	1.85	83300 18700	46300 10400	1.80	404000 90900	6386	6320-B
66.675 2.6250	130.200 5.1260	19.865 0.7821	229000 51500	0.50	1.20	59400 13400	51100 11500	1.16	256000 57600	HM813844	HM813815-B
66.675 2.6250	123.825 4.8750	14.288 0.5625	226000 50800	0.35	1.73	58600 13200	34700 7810	1.69	248000 55700	560	552-B
66.675 2.6250	120.000 4.7244	11.095 0.4368	143000 32200	0.38	1.56	37200 8360	24500 5500	1.52	186000 41900	479	472-B
66.675 2.6250	112.712 4.4375	11.112 0.4375	139000 31200	0.40	1.49	36000 8090	24800 5570	1.45	191000 43000	3984	3920-B

⁽¹⁾Based on 1 x 10⁶ revolutions L₁₀ life, for the ISO life-calculation method.

⁽²⁾Consult your Timken engineer for instructions on use or review the Timken Engineering Manual on timken.com/catalogs.

⁽³⁾Based on 90 x 10⁶ revolutions L₁₀ life, for The Timken Company life-calculation method. C₉₀ and C_{a90} are radial and thrust values.

Bearing Dimensions									Geometry Factors			Bearing Weight
Width B	Width C	Eff. Ctr. a ⁽⁴⁾	Outer Ring Flange O.D. D ₁	Flange Width C ₂	Shaft			Housing	G ₁	G ₂	C _g	
					Max Shaft Fillet Radius R ⁽⁵⁾	Backing Shoulder Dia. d _a	Backing Shoulder Dia. d _b	Backing Shoulder Dia. D _a				
mm in.	mm in.	mm in.	mm in.	mm in.	mm in.	mm in.	mm in.	mm in.				kg lbs.
29.007 1.1420	24.237 0.9542	-4.1 -0.16	125.435 4.9384	5.537 0.2180	3.5 0.14	72.0 2.83	78.0 3.07	115.0 4.53	77.2	23.0	0.1083	1.51 3.32
21.996 0.8660	23.812 0.9375	-0.8 -0.03	117.373 4.6210	4.762 0.1875	3.5 0.14	70.0 2.76	77.0 3.03	108.0 4.25	56.0	21.4	0.0984	1.05 2.32
30.048 1.1830	23.812 0.9375	-4.6 -0.18	117.373 4.6210	4.762 0.1875	3.5 0.14	71.0 2.80	77.0 3.03	108.0 4.25	75.2	21.3	0.1092	1.26 2.79
25.400 1.0000	19.050 0.7500	-0.8 -0.03	111.816 4.4022	3.970 0.1563	3.5 0.14	71.0 2.80	77.0 3.03	105.0 4.13	70.3	25.9	0.1112	0.95 2.10
22.000 0.8661	15.875 0.6250	-1.5 -0.06	109.433 4.3084	4.762 0.1875	2.0 0.08	69.0 2.72	73.0 2.87	102.0 4.02	51.7	19.5	0.0947	0.71 1.57
54.229 2.1350	44.450 1.7500	-15.0 -0.59	157.061 6.1835	7.938 0.3125	3.5 0.14	81.0 3.19	87.0 3.43	140.0 5.51	158.3	29.1	0.0931	4.89 10.79
36.170 1.4240	28.575 1.1250	-8.1 -0.32	133.248 5.2460	6.350 0.2500	3.5 0.14	74.0 2.91	81.0 3.19	121.0 4.76	101.3	24.0	0.1167	2.11 4.67
29.007 1.1420	24.237 0.9542	-4.1 -0.16	125.435 4.9384	5.537 0.2180	2.3 0.09	73.0 2.87	77.0 3.03	115.0 4.53	77.2	23.0	0.1083	1.48 3.26
56.007 2.2050	44.450 1.7500	-19.3 -0.76	143.579 5.6527	7.938 0.3125	3.5 0.14	77.0 3.04	84.0 3.31	126.0 4.96	123.5	22.4	0.0827	3.75 8.27
43.764 1.7230	36.512 1.4375	-12.2 -0.48	128.588 5.0625	6.350 0.2500	3.5 0.14	77.0 3.03	83.0 3.27	118.0 4.65	110.4	24.2	0.0825	2.29 5.05
46.038 1.8125	36.512 1.4375	-8.6 -0.34	152.400 6.0000	7.938 0.3125	3.5 0.14	85.0 3.35	91.0 3.58	135.0 5.31	147.1	33.5	0.0993	3.67 8.08
41.275 1.6250	31.750 1.2500	-11.2 -0.44	143.561 5.6520	7.137 0.2810	3.5 0.14	77.0 3.03	83.0 3.27	125.0 4.92	106.4	21.0	0.0814	2.80 6.18
56.007 2.2050	44.450 1.7500	-19.3 -0.76	143.579 5.6527	7.938 0.3125	4.3 0.17	77.0 3.04	87.0 3.43	126.0 4.96	123.5	22.4	0.0827	3.67 8.10
36.512 1.4375	26.988 1.0625	-3.8 -0.15	138.201 5.4410	10.340 0.4071	3.5 0.14	82.0 3.23	88.0 3.46	124.0 4.88	91.7	22.9	0.1252	2.26 4.98
36.678 1.4440	30.162 1.1875	-9.4 -0.37	130.073 5.1210	6.350 0.2500	3.5 0.14	77.0 3.03	84.0 3.31	116.0 4.57	91.0	21.1	0.1108	1.96 4.31
29.007 1.1420	24.237 0.9542	-4.1 -0.16	125.435 4.9384	5.537 0.2180	2.3 0.09	74.0 2.91	78.0 3.07	115.0 4.53	77.2	23.0	0.1083	1.45 3.17
30.048 1.1830	23.812 0.9375	-4.6 -0.18	117.373 4.6210	4.762 0.1875	3.5 0.14	74.0 2.91	80.0 3.15	108.0 4.25	75.2	21.3	0.1092	1.18 2.62

⁽⁴⁾Negative value indicates effective center inside cone (inner-ring) backface.

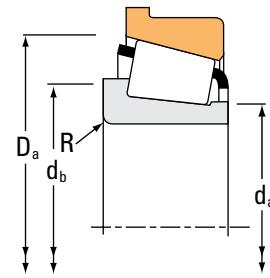
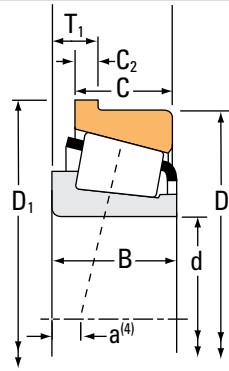
⁽⁵⁾These maximum fillet radii will be cleared by the bearing corners.

Continued on next page.

TAPERED ROLLER BEARINGS

SINGLE-ROW • TYPE TSF

TYPE TSF



Bearing Dimensions			Load Ratings							Part Number		
Bore d	O.D. D	Width T ₁	Dynamic ⁽¹⁾		Factors ⁽²⁾		Dynamic ⁽³⁾		Factors ⁽²⁾	Static C ₀	Inner	Outer
			C ₁	e	Y	C ₉₀	C _{a90}	K	N lbf			
mm in.	mm in.	mm in.	N lbf			N lbf	N lbf		N lbf			
66.675 2.6250	107.950 4.2500	10.320 0.4063	131000 29400	0.46	1.31	33800 7610	26600 5970	1.27	161000 36300	29590	29520-B	
68.262 2.6875	161.925 6.3750	24.600 0.9685	353000 79300	0.71	0.85	91400 20600	111000 24900	0.82	330000 74200	9278	9221-B	
68.262 2.6875	136.525 5.3750	16.662 0.6560	233000 52400	0.36	1.66	60400 13600	37400 8420	1.61	298000 67000	642	632-B	
68.262 2.6875	127.000 5.0000	14.288 0.5625	196000 44100	0.36	1.65	50900 11400	31700 7130	1.61	262000 58900	570	563-B	
68.262 2.6875	120.000 4.7244	11.095 0.4368	143000 32200	0.38	1.56	37200 8360	24500 5500	1.52	186000 41900	480	472-B	
68.262 2.6875	110.000 4.3307	7.925 0.3120	98900 22200	0.40	1.49	25600 5760	17600 3970	1.45	125000 28100	399A	394AB	
69.850 2.7500	168.275 6.6250	22.225 0.8750	485000 109000	0.30	2.00	126000 28300	64400 14500	1.95	522000 117000	835	832-B	
69.850 2.7500	152.400 6.0000	16.667 0.6562	247000 55500	0.41	1.47	64000 14400	44800 10100	1.43	335000 75300	655	652-B	
69.850 2.7500	150.089 5.9090	15.875 0.6250	377000 84700	0.33	1.84	97600 21900	54400 12200	1.80	417000 93800	745A	742-B	
69.850 2.7500	149.225 5.8750	17.462 0.6875	411000 92400	0.36	1.66	107000 24000	66000 14800	1.61	463000 104000	6454	6420-B	
69.850 2.7500	136.525 5.3750	16.662 0.6560	276000 62100	0.36	1.66	71600 16100	44400 9980	1.61	298000 67000	643	632-B	
69.850 2.7500	127.000 5.0000	14.288 0.5625	196000 44100	0.36	1.65	50900 11400	31700 7130	1.61	262000 58900	566	563-B	
69.850 2.7500	120.000 4.7244	11.095 0.4368	143000 32200	0.38	1.56	37200 8360	24500 5500	1.52	186000 41900	482	472-B	
69.850 2.7500	112.712 4.4375	10.320 0.4063	111000 24800	0.49	1.23	28600 6440	23900 5370	1.20	166000 37200	29675	29620-B	
69.850 2.7500	112.712 4.4375	11.112 0.4375	101000 22700	0.42	1.44	26200 5880	18600 4190	1.40	130000 29300	LM613449	LM613410-B	
69.952 2.7540	122.238 4.8125	7.938 0.3125	102000 23000	0.45	1.33	26500 5960	20500 4600	1.30	136000 30600	34274	34481-B	
70.000 2.7559	122.238 4.8125	7.938 0.3125	102000 23000	0.45	1.33	26500 5960	20500 4600	1.30	136000 30600	34275	34481-B	

⁽¹⁾Based on 1 x 10⁶ revolutions L₁₀ life, for the ISO life-calculation method.

⁽²⁾Consult your Timken engineer for instructions on use or review the Timken Engineering Manual on timken.com/catalogs.

⁽³⁾Based on 90 x 10⁶ revolutions L₁₀ life, for The Timken Company life-calculation method. C₉₀ and C_{a90} are radial and thrust values.

Bearing Dimensions									Geometry Factors			Bearing Weight
Width B	Width C	Eff. Ctr. a ⁽⁴⁾	Outer Ring Flange O.D. D ₁	Flange Width C ₂	Shaft			Housing	G ₁	G ₂	C _g	
					Max Shaft Fillet Radius R ⁽⁵⁾	Backing Shoulder Dia.		Backing Shoulder Dia. D _a				
mm in.	mm in.	mm in.	mm in.	mm in.	mm in.	mm in.	mm in.	mm in.				kg lbs.
25.400 1.0000	19.050 0.7500	-0.8 -0.03	111.816 4.4022	3.970 0.1563	3.5 0.14	73.0 2.87	80.0 3.15	105.0 4.13	70.3	25.9	0.1112	0.88 1.96
46.038 1.8125	30.162 1.1875	0.0 0.00	171.450 6.7500	7.137 0.2810	3.5 0.14	89.0 3.50	106.0 4.17	153.0 6.03	102.5	16.1	0.0984	4.60 10.13
41.275 1.6250	31.750 1.2500	-11.2 -0.44	143.561 5.6520	7.137 0.2810	3.5 0.14	78.0 3.07	85.0 3.35	125.0 4.92	106.4	21.0	0.0814	2.75 6.06
36.170 1.4240	28.575 1.1250	-8.1 -0.32	133.248 5.2460	6.350 0.2500	3.5 0.14	77.0 3.03	83.0 3.27	121.0 4.76	101.3	24.0	0.1167	2.02 4.45
29.007 1.1420	24.237 0.9542	-4.1 -0.16	125.435 4.9384	5.537 0.2180	3.5 0.14	75.0 2.95	82.0 3.23	115.0 4.53	77.2	23.0	0.1083	1.40 3.08
21.996 0.8660	18.824 0.7411	-0.8 -0.03	114.673 4.5147	4.750 0.1870	2.3 0.09	74.0 2.91	78.0 3.07	106.0 4.17	56.0	21.4	0.0984	0.79 1.73
56.363 2.2190	41.275 1.6250	-18.5 -0.73	177.698 6.9960	9.525 0.3750	3.5 0.14	84.0 3.31	91.0 3.58	155.0 6.10	197.9	34.8	0.0937	6.28 13.84
41.275 1.6250	31.750 1.2500	-7.9 -0.31	159.441 6.2772	7.142 0.2812	3.5 0.14	82.0 3.23	88.0 3.46	141.0 5.55	136.6	27.3	0.0919	3.70 8.17
46.672 1.8375	36.512 1.4375	-11.9 -0.47	157.912 6.2170	7.938 0.3125	3.5 0.14	82.0 3.23	88.0 3.46	143.0 5.63	159.6	26.3	0.0898	4.04 8.89
54.229 2.1350	44.450 1.7500	-15.0 -0.59	157.061 6.1835	7.938 0.3125	5.0 0.20	85.0 3.35	94.0 3.70	140.0 5.51	158.3	29.1	0.0931	4.66 10.28
41.275 1.6250	31.750 1.2500	-11.2 -0.44	143.561 5.6520	7.137 0.2810	3.5 0.14	80.0 3.15	86.0 3.39	125.0 4.92	106.4	21.0	0.0814	2.69 5.93
36.170 1.4240	28.575 1.1250	-8.1 -0.32	133.248 5.2460	6.350 0.2500	3.5 0.14	78.0 3.07	85.0 3.35	121.0 4.76	101.3	24.0	0.1167	1.97 4.34
29.007 1.1420	24.237 0.9542	-4.1 -0.16	125.435 4.9384	5.537 0.2180	3.5 0.14	77.0 3.03	83.0 3.27	115.0 4.53	77.2	23.0	0.1083	1.36 2.99
25.400 1.0000	19.050 0.7500	1.0 0.04	116.586 4.5900	3.970 0.1563	1.5 0.06	77.0 3.03	80.0 3.15	110.0 4.33	77.7	43.3	0.1170	0.98 2.18
21.996 0.8660	15.875 0.6250	0.0 0.00	119.062 4.6875	4.762 0.1875	1.5 0.06	76.0 2.99	78.0 3.07	110.0 4.33	60.3	23.1	0.1019	0.82 1.82
23.012 0.9060	21.430 0.8437	1.5 0.06	126.901 4.9961	4.762 0.1875	2.0 0.08	78.0 3.07	81.0 3.19	118.0 4.65	69.3	27.0	0.1093	1.18 2.60
23.012 0.9060	21.430 0.8437	1.5 0.06	126.901 4.9961	4.762 0.1875	2.0 0.08	78.0 3.07	82.0 3.23	118.0 4.65	69.3	27.0	0.1093	1.18 2.60

⁽⁴⁾Negative value indicates effective center inside cone (inner-ring) backface.

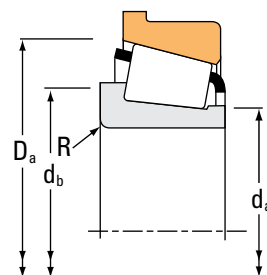
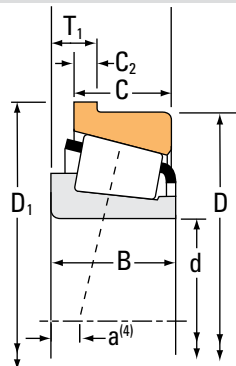
⁽⁵⁾These maximum fillet radii will be cleared by the bearing corners.

Continued on next page.

TAPERED ROLLER BEARINGS

SINGLE-ROW • TYPE TSF

TYPE TSF



Bearing Dimensions			Load Ratings							Part Number		
Bore d	O.D. D	Width T ₁	Dynamic ⁽¹⁾		Factors ⁽²⁾		Dynamic ⁽³⁾		Factors ⁽²⁾	Static	Inner	Outer
			C ₁	e	Y	C ₉₀	C _{a90}	K	C ₀			
mm in.	mm in.	mm in.	N lbf			N lbf	N lbf			N lbf		
70.000 2.7559	120.000 4.7244	11.095 0.4368	143000 32200	0.38	1.56	37200 8360	24500 5500	1.52		186000 41900	484	472-B
70.000 2.7559	110.000 4.3307	8.500 0.3346	91600 20600	0.46	1.30	23700 5340	18700 4210	1.27		112000 25200	JP7049	JP7010-B
71.437 2.8125	139.700 5.5000	17.462 0.6875	319000 71700	0.47	1.27	82700 18600	67000 15100	1.24		405000 91000	H715345	H715310-B
71.437 2.8125	136.525 5.3750	16.637 0.6550	323000 72600	0.36	1.67	83700 18800	51600 11600	1.62		335000 75400	H414249	H414210-B
71.437 2.8125	136.525 5.3750	16.662 0.6560	276000 62100	0.36	1.66	71600 16100	44400 9980	1.61		298000 67000	645	632-B
71.437 2.8125	127.000 5.0000	14.288 0.5625	196000 44100	0.36	1.65	50900 11400	31700 7130	1.61		262000 58900	567A	563-B
71.437 2.8125	117.475 4.6250	11.112 0.4375	138000 31100	0.44	1.38	35900 8060	26800 6020	1.34		197000 44300	33281	33462-B
73.025 2.8750	152.400 6.0000	16.667 0.6562	247000 55500	0.41	1.47	64000 14400	44800 10100	1.43		335000 75300	657	652-B
73.025 2.8750	149.225 5.8750	17.462 0.6875	411000 92400	0.36	1.66	107000 24000	66000 14800	1.61		463000 104000	6460	6420-B
73.025 2.8750	127.000 5.0000	14.288 0.5625	196000 44100	0.36	1.65	50900 11400	31700 7130	1.61		262000 58900	567	563-B
73.025 2.8750	127.000 5.0000	14.288 0.5625	196000 44100	0.36	1.65	50900 11400	31700 7130	1.61		262000 58900	567X	563-B
73.025 2.8750	117.475 4.6250	11.112 0.4375	118000 26500	0.51	1.18	30600 6870	26700 5990	1.15		183000 41200	LM814845	LM814810-B
73.025 2.8750	112.712 4.4375	10.320 0.4063	111000 24800	0.49	1.23	28600 6440	23900 5370	1.20		166000 37200	29685	29620-B
73.817 2.9062	127.000 5.0000	14.288 0.5625	196000 44100	0.36	1.65	50900 11400	31700 7130	1.61		262000 58900	568	563-B
74.612 2.9375	139.992 5.5115	14.288 0.5625	207000 46500	0.40	1.49	53600 12100	37100 8330	1.45		291000 65400	577	572-B
76.200 3.0000	168.275 6.6250	22.225 0.8750	485000 109000	0.30	2.00	126000 28300	64400 14500	1.95		522000 117000	837	832-B
76.200 3.0000	161.925 6.3750	17.450 0.6870	327000 73600	0.34	1.76	84800 19100	49500 11100	1.71		441000 99200	755	752-B

⁽¹⁾Based on 1 x 10⁶ revolutions L₁₀ life, for the ISO life-calculation method.

⁽²⁾Consult your Timken engineer for instructions on use or review the Timken Engineering Manual on timken.com/catalogs.

⁽³⁾Based on 90 x 10⁶ revolutions L₁₀ life, for The Timken Company life-calculation method. C₉₀ and C_{a90} are radial and thrust values.

Bearing Dimensions									Geometry Factors			Bearing Weight
Width B	Width C	Eff. Ctr. a ⁽⁴⁾	Outer Ring Flange O.D. D ₁	Flange Width C ₂	Shaft			Housing	G ₁	G ₂	C _g	
					Max Shaft Fillet Radius R ⁽⁵⁾	Backing Shoulder Dia.		Backing Shoulder Dia. D _a				
mm in.	mm in.	mm in.	mm in.	mm in.	mm in.	mm in.	mm in.	mm in.				kg lbs.
29.007 1.1420	24.237 0.9542	-4.1 -0.16	125.435 4.9384	5.537 0.2180	2.0 0.08	77.0 3.03	80.0 3.15	115.0 4.53	77.2	23.0	0.1083	1.37 3.00
20.000 0.7874	15.500 0.6102	2.5 0.10	116.000 4.5669	3.000 0.1181	2.0 0.08	76.0 2.99	80.0 3.15	105.4 4.15	51.1	31.0	0.0995	0.70 1.55
46.038 1.8125	36.512 1.4375	-8.6 -0.34	152.400 6.0000	7.938 0.3125	3.5 0.14	88.0 3.46	94.0 3.70	135.0 5.31	147.1	33.5	0.0993	3.48 7.68
41.275 1.6250	31.750 1.2500	-10.9 -0.43	143.637 5.6550	7.112 0.2800	3.5 0.14	83.3 3.27	89.0 3.50	130.0 5.12	112.8	22.9	0.0827	2.66 5.87
41.275 1.6250	31.750 1.2500	-11.2 -0.44	143.561 5.6520	7.137 0.2810	6.4 0.25	81.0 3.19	93.0 3.66	125.0 4.92	106.4	21.0	0.0814	2.61 5.75
36.170 1.4240	28.575 1.1250	-8.1 -0.32	133.248 5.2460	6.350 0.2500	3.5 0.14	80.0 3.15	86.0 3.39	121.0 4.76	101.3	24.0	0.1167	1.92 4.23
30.162 1.1875	23.812 0.9375	-2.8 -0.11	122.133 4.8084	4.762 0.1875	3.5 0.14	80.0 3.15	87.0 3.43	114.0 4.49	84.2	25.9	0.1162	1.30 2.86
41.275 1.6250	31.750 1.2500	-7.9 -0.31	159.441 6.2772	7.142 0.2812	3.5 0.14	85.0 3.35	91.0 3.58	141.0 5.55	136.6	27.3	0.0919	3.59 7.91
54.229 2.1350	44.450 1.7500	-15.0 -0.59	157.061 6.1835	7.938 0.3125	3.5 0.14	87.0 3.43	93.0 3.66	140.0 5.51	158.3	29.1	0.0931	4.52 9.97
36.170 1.4240	28.575 1.1250	-8.1 -0.32	133.248 5.2460	6.350 0.2500	3.5 0.14	81.0 3.19	88.0 3.46	121.0 4.76	101.3	24.0	0.1167	1.87 4.12
36.170 1.4240	28.575 1.1250	-8.1 -0.32	133.248 5.2460	6.350 0.2500	4.8 0.19	81.0 3.19	90.0 3.54	121.0 4.76	101.3	24.0	0.1167	1.87 4.13
25.400 1.0000	19.050 0.7500	2.3 0.09	122.133 4.8084	4.762 0.1875	3.5 0.14	81.0 3.19	87.0 3.43	116.0 4.57	88.6	36.6	0.1239	1.07 2.35
25.400 1.0000	19.050 0.7500	1.0 0.04	116.586 4.5900	3.970 0.1563	3.5 0.14	80.0 3.15	86.0 3.39	110.0 4.33	77.7	43.3	0.1170	0.91 2.02
36.170 1.4240	28.575 1.1250	-8.1 -0.32	133.248 5.2460	6.350 0.2500	0.8 0.03	82.0 3.23	83.0 3.27	121.0 4.76	101.3	24.0	0.1167	1.85 4.09
36.098 1.4212	28.575 1.1250	-5.3 -0.21	146.240 5.7575	6.350 0.2500	3.5 0.14	85.0 3.35	91.0 3.58	134.0 5.28	125.7	32.0	0.1295	2.48 5.47
56.363 2.2190	41.275 1.6250	-18.5 -0.73	177.698 6.9960	9.525 0.3750	0.8 0.03	89.0 3.50	90.0 3.54	155.0 6.10	197.9	34.8	0.0937	5.97 13.15
48.260 1.9000	38.100 1.5000	-11.9 -0.47	169.748 6.6830	7.925 0.3120	3.5 0.14	92.0 3.62	98.0 3.86	150.0 5.91	177.2	29.4	0.0945	4.84 10.66

⁽⁴⁾Negative value indicates effective center inside cone (inner-ring) backface.

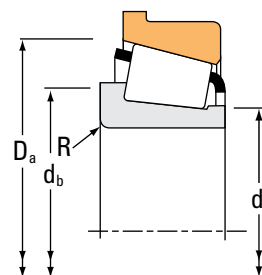
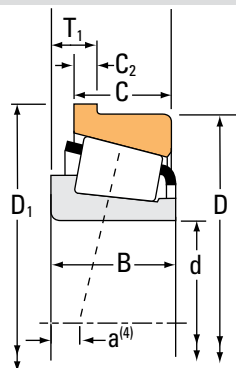
⁽⁵⁾These maximum fillet radii will be cleared by the bearing corners.

Continued on next page.

TAPERED ROLLER BEARINGS

SINGLE-ROW • TYPE TSF

TYPE TSF



Bearing Dimensions			Load Ratings							Part Number		
Bore d	O.D. D	Width T ₁	Dynamic ⁽¹⁾		Factors ⁽²⁾		Dynamic ⁽³⁾		Factors ⁽²⁾	Static C ₀	Inner	Outer
			C ₁	e	Y	C ₉₀	C _{a90}	K	C ₀			
mm in.	mm in.	mm in.	N lbf			N lbf	N lbf		N lbf			
76.200 3.0000	161.925 6.3750	19.050 0.7500	439000 98800	0.40	1.50	114000 25600	78100 17600	1.46	523000 118000		6575	6535-B
76.200 3.0000	161.925 6.3750	24.600 0.9685	353000 79300	0.71	0.85	91400 20600	111000 24900	0.82	330000 74200		9285	9221-B
76.200 3.0000	149.225 5.8750	17.462 0.6875	411000 92400	0.36	1.66	107000 24000	66000 14800	1.61	463000 104000		6461	6420-B
76.200 3.0000	139.992 5.5115	14.288 0.5625	207000 46500	0.40	1.49	53600 12100	37100 8330	1.45	291000 65400		575	572-B
76.200 3.0000	136.525 5.3750	13.475 0.5305	154000 34700	0.44	1.35	40000 9000	30500 6850	1.31	216000 48600		495A	493-B
76.200 3.0000	130.000 5.1181	13.495 0.5313	161000 36200	0.42	1.43	41800 9390	29900 6730	1.39	222000 49800		42687	42623-B
76.200 3.0000	125.412 4.9375	10.317 0.4062	117000 26300	0.42	1.44	30400 6830	21600 4860	1.40	178000 39900		27684	27620-B
76.200 3.0000	122.238 4.8125	7.938 0.3125	102000 23000	0.45	1.33	26500 5960	20500 4600	1.30	136000 30600		34300	34481-B
76.200 3.0000	122.238 4.8125	7.940 0.3126	102000 23000	0.45	1.33	26500 5960	20500 4600	1.30	136000 30600		34301	34481-B
77.788 3.0625	127.000 5.0000	13.495 0.5313	161000 36200	0.42	1.43	41800 9390	29900 6730	1.39	222000 49800		42690	42620-B
77.788 3.0625	122.238 4.8125	7.938 0.3125	121000 27200	0.45	1.33	31400 7060	24200 5450	1.30	136000 30600		34306	34481-B
77.788 3.0625	117.475 4.6250	11.112 0.4375	118000 26500	0.51	1.18	30600 6870	26700 5990	1.15	183000 41200		LM814849	LM814810-B
79.375 3.1250	152.400 6.0000	15.875 0.6250	216000 48600	0.44	1.36	56000 12600	42400 9530	1.32	319000 71600		595A	592-B
79.985 3.1490	152.400 6.0000	15.875 0.6250	216000 48600	0.44	1.36	56000 12600	42400 9530	1.32	319000 71600		590	592-B
80.000 3.1496	125.000 4.9213	10.500 0.4134	107000 24000	0.45	1.33	27700 6230	21400 4820	1.29	141000 31800		JP8049	JP8010-B
80.962 3.1875	168.275 6.6250	22.225 0.8750	409000 92000	0.30	2.00	106000 23800	54300 12200	1.95	522000 117000		838	832-B
80.962 3.1875	139.992 5.5115	14.288 0.5625	207000 46500	0.40	1.49	53600 12100	37100 8330	1.45	291000 65400		581	572-B

⁽¹⁾Based on 1 x 10⁶ revolutions L₁₀ life, for the ISO life-calculation method.

⁽²⁾Consult your Timken engineer for instructions on use or review the Timken Engineering Manual on timken.com/catalogs.

⁽³⁾Based on 90 x 10⁶ revolutions L₁₀ life, for The Timken Company life-calculation method. C₉₀ and C_{a90} are radial and thrust values.

Bearing Dimensions									Geometry Factors			Bearing Weight
Width B	Width C	Eff. Ctr. a ⁽⁴⁾	Outer Ring Flange O.D. D ₁	Flange Width C ₂	Shaft			Housing	G ₁	G ₂	C _g	
					Max Shaft Fillet Radius R ⁽⁵⁾	Backing Shoulder Dia.		Backing Shoulder Dia. D _a				
mm in.	mm in.	mm in.	mm in.	mm in.	mm in.	mm in.	mm in.	mm in.				kg lbs.
55.100 2.1693	42.862 1.6875	-13.2 -0.52	171.450 6.7500	7.938 0.3125	6.4 0.25	92.0 3.62	104.0 4.09	155.0 6.10	198.6	33.5	0.1037	5.47 12.07
46.038 1.8125	30.162 1.1875	0.0 0.00	171.450 6.7500	7.137 0.2810	3.5 0.14	89.0 3.50	111.0 4.37	153.0 6.03	102.5	16.1	0.0984	4.27 9.41
54.229 2.1350	44.450 1.7500	-15.0 -0.59	157.061 6.1835	7.938 0.3125	3.5 0.14	89.0 3.52	96.0 3.78	140.0 5.51	158.3	29.1	0.0931	4.36 9.63
36.098 1.4212	28.575 1.1250	-5.3 -0.21	146.240 5.7575	6.350 0.2500	3.5 0.14	86.0 3.39	92.0 3.62	134.0 5.28	125.7	32.0	0.1295	2.42 5.35
29.769 1.1720	22.225 0.8750	-0.8 -0.03	141.961 5.5890	5.537 0.2180	3.5 0.14	86.0 3.39	92.0 3.62	131.0 5.16	104.6	29.3	0.1252	1.86 4.09
31.000 1.2205	22.225 0.8750	-2.8 -0.11	135.456 5.3329	5.558 0.2188	3.5 0.14	84.0 3.31	90.0 3.54	124.0 4.88	96.2	28.6	0.1197	1.61 3.55
25.400 1.0000	19.845 0.7813	0.5 0.02	130.076 5.1211	4.762 0.1875	3.5 0.14	84.0 3.31	91.0 3.58	123.0 4.84	98.2	41.8	0.1198	1.25 2.76
23.012 0.9060	21.430 0.8437	1.5 0.06	126.901 4.9961	4.762 0.1875	2.0 0.08	83.0 3.27	86.0 3.39	118.0 4.65	69.3	27.0	0.1093	1.05 2.32
23.012 0.9060	21.430 0.8437	1.5 0.06	126.901 4.9961	4.762 0.1875	3.5 0.14	83.0 3.27	89.0 3.50	118.0 4.65	69.3	27.0	0.1093	1.04 2.30
31.000 1.2205	22.225 0.8750	-2.8 -0.11	133.248 5.2460	5.558 0.2188	3.5 0.14	85.0 3.35	91.0 3.58	124.0 4.88	96.2	28.6	0.1197	1.43 3.14
23.012 0.9060	21.430 0.8437	1.5 0.06	126.901 4.9961	4.762 0.1875	3.5 0.14	84.0 3.31	91.0 3.58	118.0 4.65	69.3	27.0	0.1093	1.00 2.22
25.400 1.0000	19.050 0.7500	2.3 0.09	122.133 4.8084	4.762 0.1875	3.5 0.14	85.0 3.35	91.0 3.58	116.0 4.57	88.6	36.6	0.1239	0.96 2.11
36.322 1.4300	30.162 1.1875	-2.5 -0.10	158.648 6.2460	6.350 0.2500	3.5 0.14	91.0 3.58	98.0 3.86	144.0 5.67	151.4	38.3	0.1416	3.18 7.00
36.322 1.4300	30.162 1.1875	-2.5 -0.10	158.648 6.2460	6.350 0.2500	3.5 0.14	91.0 3.58	98.0 3.86	144.0 5.67	151.4	38.3	0.1416	3.16 6.95
22.500 0.8858	17.500 0.6890	2.3 0.09	132.000 5.1969	4.000 0.1575	2.0 0.08	86.0 3.39	89.0 3.50	129.0 5.08	69.7	37.4	0.1095	1.02 2.22
56.363 2.2190	41.275 1.6250	-18.5 -0.73	177.698 6.9960	9.525 0.3750	0.8 0.03	93.0 3.66	94.0 3.70	155.0 6.10	197.9	34.8	0.0937	5.71 12.58
36.098 1.4212	28.575 1.1250	-5.3 -0.21	146.240 5.7575	6.350 0.2500	3.5 0.14	90.0 3.54	96.0 3.78	134.0 5.28	125.7	32.0	0.1295	2.26 4.98

⁽⁴⁾Negative value indicates effective center inside cone (inner-ring) backface.

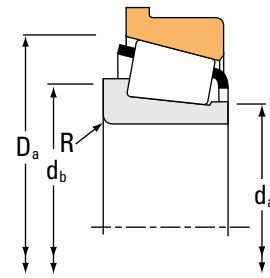
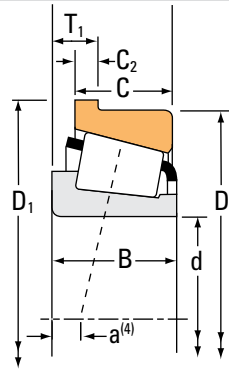
⁽⁵⁾These maximum fillet radii will be cleared by the bearing corners.

Continued on next page.

TAPERED ROLLER BEARINGS

SINGLE-ROW • TYPE TSF

TYPE TSF



Bearing Dimensions			Load Ratings							Part Number	
Bore d	O.D. D	Width T ₁	Dynamic ⁽¹⁾			Dynamic ⁽³⁾			Static C ₀	Inner	Outer
			C ₁	e	Y	C ₉₀	C _{a90}	K			
mm in.	mm in.	mm in.	N lbf			N lbf	N lbf		N lbf		
80.962 3.1875	136.525 5.3750	13.475 0.5305	154000 34700	0.44	1.35	40000 9000	30500 6850	1.31	216000 48600	496	493-B
80.962 3.1875	133.350 5.2500	12.700 0.5000	214000 48100	0.40	1.48	55500 12500	38400 8640	1.44	262000 58900	47681	47620-B
82.550 3.2500	168.275 6.6250	22.225 0.8750	409000 92000	0.30	2.00	106000 23800	54300 12200	1.95	522000 117000	839	832-B
82.550 3.2500	168.275 6.6250	22.225 0.8750	485000 109000	0.30	2.00	126000 28300	64400 14500	1.95	522000 117000	842	832-B
82.550 3.2500	161.925 6.3750	17.450 0.6870	327000 73600	0.34	1.76	84800 19100	49500 11100	1.71	441000 99200	757	752-B
82.550 3.2500	152.400 6.0000	15.875 0.6250	216000 48600	0.44	1.36	56000 12600	42400 9530	1.32	319000 71600	595	592-B
82.550 3.2500	152.400 6.0000	16.667 0.6562	247000 55500	0.41	1.47	64000 14400	44800 10100	1.43	335000 75300	663	652-B
82.550 3.2500	139.992 5.5115	14.288 0.5625	207000 46500	0.40	1.49	53600 12100	37100 8330	1.45	291000 65400	580	572-B
82.550 3.2500	136.525 5.3750	13.475 0.5305	154000 34700	0.44	1.35	40000 9000	30500 6850	1.31	216000 48600	495	493-B
82.550 3.2500	133.350 5.2500	12.700 0.5000	214000 48100	0.40	1.48	55500 12500	38400 8640	1.44	262000 58900	47686	47620-B
82.550 3.2500	133.350 5.2500	12.700 0.5000	214000 48100	0.40	1.48	55500 12500	38400 8640	1.44	262000 58900	47685	47620-B
82.550 3.2500	125.412 4.9375	10.317 0.4062	117000 26300	0.42	1.44	30400 6830	21600 4860	1.40	178000 39900	27687	27620-B
82.550 3.2500	115.888 4.5625	7.938 0.3125	90200 20300	0.31	1.95	23400 5260	12300 2770	1.90	147000 33100	L116149	L116110-B
83.345 3.2813	125.412 4.9375	10.317 0.4062	117000 26300	0.42	1.44	30400 6830	21600 4860	1.40	178000 39900	27690	27620-B
84.138 3.3125	136.525 5.3750	13.475 0.5305	154000 34700	0.44	1.35	40000 9000	30500 6850	1.31	216000 48600	498	493-B
85.000 3.3465	130.000 5.1181	11.557 0.4550	161000 36300	0.44	1.35	41800 9400	31800 7150	1.31	245000 55100	JM716649	JM716610-B
85.725 3.3750	168.275 6.6250	18.255 0.7187	265000 59500	0.47	1.28	68600 15400	55300 12400	1.24	386000 86700	677	672-B

⁽¹⁾Based on 1×10^6 revolutions L_{10} life, for the ISO life-calculation method.

⁽²⁾Consult your Timken engineer for instructions on use or review the Timken Engineering Manual on timken.com/catalogs.

⁽³⁾Based on 90×10^6 revolutions L_{10} life, for The Timken Company life-calculation method. C_{90} and C_{a90} are radial and thrust values.

Bearing Dimensions									Geometry Factors			Bearing Weight
Width B	Width C	Eff. Ctr. a ⁽⁴⁾	Outer Ring Flange O.D. D ₁	Flange Width C ₂	Shaft			Housing	G ₁	G ₂	C _g	
					Max Shaft Fillet Radius R ⁽⁵⁾	Backing Shoulder Dia.		Backing Shoulder Dia. D _a				
mm in.	mm in.	mm in.	mm in.	mm in.	mm in.	mm in.	mm in.	mm in.				kg lbs.
29.769 1.1720	22.225 0.8750	-0.8 -0.03	141.961 5.5890	5.537 0.2180	3.5 0.14	89.0 3.50	95.0 3.74	131.0 5.16	104.6	29.3	0.1252	1.72 3.79
33.338 1.3125	26.195 1.0313	-4.3 -0.17	138.811 5.4650	5.558 0.2188	3.5 0.14	89.0 3.50	95.0 3.74	130.0 5.12	119.4	29.2	0.1273	1.90 4.18
56.363 2.2190	41.275 1.6250	-18.5 -0.73	177.698 6.9960	9.525 0.3750	0.8 0.03	94.0 3.70	95.0 3.74	155.0 6.10	197.9	34.8	0.0937	5.62 12.38
56.363 2.2190	41.275 1.6250	-18.5 -0.73	177.698 6.9960	9.525 0.3750	3.5 0.14	94.0 3.70	101.0 3.98	155.0 6.10	197.9	34.8	0.0937	5.60 12.35
48.260 1.9000	38.100 1.5000	-11.9 -0.47	169.748 6.6830	7.925 0.3120	3.5 0.14	94.0 3.70	100.0 3.94	150.0 5.91	177.2	29.4	0.0945	4.53 9.98
36.322 1.4300	30.162 1.1875	-2.5 -0.10	158.648 6.2460	6.350 0.2500	3.5 0.14	93.0 3.66	100.0 3.94	144.0 5.67	151.4	38.3	0.1416	3.06 6.75
41.275 1.6250	31.750 1.2500	-7.9 -0.31	159.441 6.2772	7.142 0.2812	3.5 0.14	92.0 3.62	99.0 3.90	141.0 5.55	136.6	27.3	0.0919	3.21 7.08
36.098 1.4212	28.575 1.1250	-5.3 -0.21	146.240 5.7575	6.350 0.2500	3.5 0.14	91.0 3.58	98.0 3.86	134.0 5.28	125.7	32.0	0.1295	2.20 4.87
29.769 1.1720	22.225 0.8750	-0.8 -0.03	141.961 5.5890	5.537 0.2180	3.5 0.14	90.0 3.54	97.0 3.82	131.0 5.16	104.6	29.3	0.1252	1.67 3.68
33.338 1.3125	26.195 1.0313	-4.3 -0.17	138.811 5.4650	5.558 0.2188	3.5 0.14	92.0 3.62	98.0 3.86	130.0 5.12	119.4	29.2	0.1273	1.85 4.08
33.338 1.3125	26.195 1.0313	-4.3 -0.17	138.811 5.4650	5.558 0.2188	0.8 0.03	90.0 3.54	91.0 3.58	130.0 5.12	119.4	29.2	0.1273	1.86 4.09
25.400 1.0000	19.845 0.7813	0.5 0.02	130.076 5.1211	4.762 0.1875	3.5 0.14	89.0 3.50	96.0 3.78	123.0 4.84	98.2	41.8	0.1198	1.10 2.43
21.433 0.8438	16.670 0.6563	-1.3 -0.05	119.855 4.7187	3.970 0.1563	1.5 0.06	87.0 3.43	90.0 3.54	113.0 4.45	97.2	64.3	0.1079	0.68 1.51
25.400 1.0000	19.845 0.7813	0.5 0.02	130.076 5.1211	4.762 0.1875	3.5 0.14	89.0 3.50	96.0 3.78	123.0 4.84	98.2	41.8	0.1198	1.08 2.38
29.769 1.1720	22.225 0.8750	-0.8 -0.03	141.961 5.5890	5.537 0.2180	3.5 0.14	91.0 3.58	98.0 3.86	131.0 5.16	104.6	29.3	0.1252	1.62 3.57
29.000 1.1417	24.000 0.9449	-0.3 -0.01	135.448 5.3346	5.558 0.2188	3.0 0.12	92.0 3.62	98.0 3.86	127.0 5.00	117.1	38.4	0.1303	1.39 3.07
41.275 1.6250	30.162 1.1875	-2.8 -0.11	175.336 6.9030	7.142 0.2812	3.5 0.14	99.0 3.90	105.0 4.13	160.0 6.30	182.5	37.3	0.1056	4.23 9.33

⁽⁴⁾Negative value indicates effective center inside cone (inner-ring) backface.

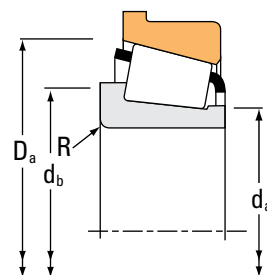
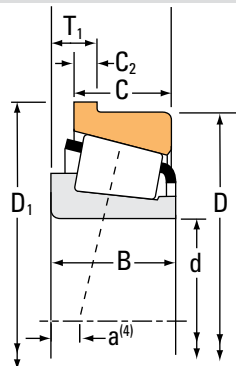
⁽⁵⁾These maximum fillet radii will be cleared by the bearing corners.

Continued on next page.

TAPERED ROLLER BEARINGS

SINGLE-ROW • TYPE TSF

TYPE TSF



Bearing Dimensions			Load Ratings							Part Number		
Bore d	O.D. D	Width T ₁	Dynamic ⁽¹⁾		Factors ⁽²⁾		Dynamic ⁽³⁾		Factors ⁽²⁾	Static C ₀	Inner	Outer
			C ₁	e	Y	C ₉₀	C _{a90}	K	C ₀			
mm in.	mm in.	mm in.	N lbf			N lbf	N lbf		N lbf			
85.725 3.3750	168.275 6.6250	22.225 0.8750	485000 109000	0.30	2.00	126000 28300	64400 14500	1.95	522000 117000		841	832-B
85.725 3.3750	161.925 6.3750	17.450 0.6870	327000 73600	0.34	1.76	84800 19100	49500 11100	1.71	441000 99200		758	752-B
85.725 3.3750	152.400 6.0000	15.875 0.6250	216000 48600	0.44	1.36	56000 12600	42400 9530	1.32	319000 71600		596	592-B
85.725 3.3750	152.400 6.0000	16.667 0.6562	247000 55500	0.41	1.47	64000 14400	44800 10100	1.43	335000 75300		665	652-B
85.725 3.3750	136.525 5.3750	13.475 0.5305	154000 34700	0.44	1.35	40000 9000	30500 6850	1.31	216000 48600		497	493-B
87.312 3.4375	152.400 6.0000	15.875 0.6250	216000 48600	0.44	1.36	56000 12600	42400 9530	1.32	319000 71600		596-S	592-B
88.900 3.5000	200.000 7.8740	27.361 1.0772	482000 108000	0.63	0.95	125000 28100	135000 30400	0.92	519000 117000		98350	98788-B
88.900 3.5000	190.500 7.5000	22.225 0.8750	458000 103000	0.33	1.79	119000 26700	68000 15300	1.74	630000 142000		855	854-B
88.900 3.5000	190.500 7.5000	22.225 0.8750	534000 120000	0.33	1.79	138000 31100	79300 17800	1.74	692000 156000		HH221434	HH221410-B
88.900 3.5000	180.975 7.1250	17.462 0.6875	346000 77800	0.39	1.56	89700 20200	59200 13300	1.51	495000 111000		775	772-B
88.900 3.5000	168.275 6.6250	18.255 0.7187	265000 59500	0.47	1.28	68600 15400	55300 12400	1.24	386000 86700		679	672-B
88.900 3.5000	161.925 6.3750	17.450 0.6870	327000 73600	0.34	1.76	84800 19100	49500 11100	1.71	441000 99200		766	752-B
88.900 3.5000	161.925 6.3750	17.462 0.6875	327000 73600	0.34	1.76	84800 19100	49500 11100	1.71	441000 99200		759	752-B
88.900 3.5000	161.925 6.3750	19.050 0.7500	439000 98800	0.40	1.50	114000 25600	78100 17600	1.46	523000 118000		6580	6535-B
88.900 3.5000	152.400 6.0000	15.875 0.6250	216000 48600	0.44	1.36	56000 12600	42400 9530	1.32	319000 71600		593	592-B
88.900 3.5000	149.225 5.8750	12.700 0.5000	193000 43400	0.49	1.22	50100 11300	42200 9480	1.19	241000 54300		42350	42587-B
90.000 3.5433	135.000 5.3150	10.500 0.4134	128000 28800	0.49	1.21	33300 7480	28100 6330	1.18	155000 34900		JP9049	JP9010-B

⁽¹⁾Based on 1×10^6 revolutions L_{10} life, for the ISO life-calculation method.

⁽²⁾Consult your Timken engineer for instructions on use or review the Timken Engineering Manual on timken.com/catalogs.

⁽³⁾Based on 90×10^6 revolutions L_{10} life, for The Timken Company life-calculation method. C_{90} and C_{a90} are radial and thrust values.

Bearing Dimensions									Geometry Factors			Bearing Weight
Width B	Width C	Eff. Ctr. a ⁽⁴⁾	Outer Ring Flange O.D. D ₁	Flange Width C ₂	Shaft			Housing	G ₁	G ₂	C _g	
					Max Shaft Fillet Radius R ⁽⁵⁾	Backing Shoulder Dia.		Backing Shoulder Dia. D _a				
mm in.	mm in.	mm in.	mm in.	mm in.	mm in.	mm in.	mm in.	mm in.				kg lbs.
56.363 2.2190	41.275 1.6250	-18.5 -0.73	177.698 6.9960	9.525 0.3750	3.5 0.14	97.0 3.82	104.0 4.09	155.0 6.10	197.9	34.8	0.0937	5.42 11.95
48.260 1.9000	38.100 1.5000	-11.9 -0.47	169.748 6.6830	7.925 0.3120	3.5 0.14	100.0 3.94	106.0 4.17	150.0 5.91	177.2	29.4	0.0945	4.38 9.65
36.322 1.4300	30.162 1.1875	-2.5 -0.10	158.648 6.2460	6.350 0.2500	3.5 0.14	96.0 3.78	102.0 4.02	144.0 5.67	151.4	38.3	0.1416	2.94 6.48
41.275 1.6250	31.750 1.2500	-7.9 -0.31	159.441 6.2772	7.142 0.2812	3.5 0.14	95.0 3.74	102.0 4.02	141.0 5.55	136.6	27.3	0.0919	3.07 6.77
29.769 1.1720	22.225 0.8750	-0.8 -0.03	141.961 5.5890	5.537 0.2180	3.5 0.14	93.0 3.66	99.0 3.90	131.0 5.16	104.6	29.3	0.1252	1.57 3.46
36.322 1.4300	30.162 1.1875	-2.5 -0.10	158.648 6.2460	6.350 0.2500	3.5 0.14	97.0 3.82	103.0 4.06	144.0 5.67	151.4	38.3	0.1416	2.88 6.35
49.212 1.9375	34.925 1.3750	1.3 0.05	209.550 8.2500	9.525 0.3750	3.5 0.14	112.0 4.41	118.0 4.65	188.0 7.40	203.4	37.5	0.1197	7.72 17.02
57.531 2.2650	44.450 1.7500	-15.2 -0.60	199.923 7.8710	9.525 0.3750	8.0 0.31	103.0 4.06	118.0 4.65	174.0 6.85	264.1	44.9	0.1072	7.88 17.39
57.531 2.2650	46.038 1.8125	-15.0 -0.59	199.923 7.8710	11.112 0.4375	8.0 0.31	105.0 4.13	120.0 4.72	179.0 7.05	265.6	28.4	0.1072	8.05 17.72
48.006 1.8900	38.100 1.5000	-8.1 -0.32	188.798 7.4330	7.938 0.3125	4.8 0.19	103.0 4.06	112.0 4.41	168.0 6.61	227.3	41.3	0.1067	5.88 12.97
41.275 1.6250	30.162 1.1875	-2.8 -0.11	175.336 6.9030	7.142 0.2812	3.5 0.14	101.0 3.98	107.0 4.21	160.0 6.30	182.5	37.3	0.1056	4.09 9.02
48.260 1.9000	38.100 1.5000	-11.9 -0.47	169.748 6.6830	7.925 0.3120	7.0 0.28	99.0 3.90	113.0 4.45	150.0 5.91	177.2	29.4	0.0945	4.17 9.17
48.260 1.9000	38.100 1.5000	-11.9 -0.47	169.748 6.6830	7.925 0.3120	3.5 0.14	101.0 3.98	108.0 4.25	150.0 5.91	177.2	29.4	0.0945	4.22 9.28
55.100 2.1693	42.862 1.6875	-13.2 -0.52	171.450 6.7500	7.938 0.3125	3.5 0.14	102.0 4.02	117.0 4.61	155.0 6.10	198.6	33.5	0.1037	4.77 10.53
36.322 1.4300	30.162 1.1875	-2.5 -0.10	158.648 6.2460	6.350 0.2500	3.5 0.14	98.0 3.86	104.0 4.09	144.0 5.67	151.4	38.3	0.1416	2.82 6.21
28.971 1.1406	24.608 0.9688	3.0 0.12	154.681 6.0898	5.558 0.2188	3.0 0.12	98.0 3.86	104.0 4.09	152.0 5.98	129.7	37.2	0.1386	2.14 4.72
22.500 0.8858	17.500 0.6890	5.6 0.22	142.000 5.5906	4.000 0.1575	2.0 0.08	97.0 3.82	100.0 3.94	133.0 5.24	83.8	46.1	0.1196	1.13 2.49

⁽⁴⁾Negative value indicates effective center inside cone (inner-ring) backface.

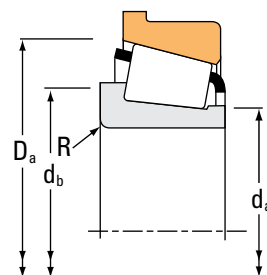
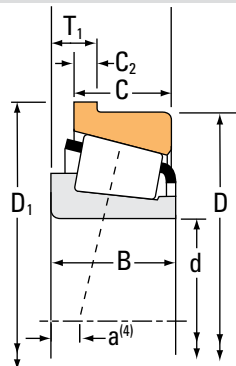
⁽⁵⁾These maximum fillet radii will be cleared by the bearing corners.

Continued on next page.

TAPERED ROLLER BEARINGS

SINGLE-ROW • TYPE TSF

TYPE TSF



Bearing Dimensions			Load Ratings							Part Number	
Bore d	O.D. D	Width T ₁	Dynamic ⁽¹⁾			Dynamic ⁽³⁾			Static C ₀	Inner	Outer
			C ₁	e	Y	C ₉₀	C _{a90}	K			
mm in.	mm in.	mm in.	N lbf			N lbf	N lbf		N lbf		
90.488 3.5625	161.925 6.3750	17.450 0.6870	327000 73600	0.34	1.76	84800 19100	49500 11100	1.71	441000 99200	760	752-B
92.075 3.6250	168.275 6.6250	18.255 0.7187	265000 59500	0.47	1.28	68600 15400	55300 12400	1.24	386000 86700	681	672-B
92.075 3.6250	152.400 6.0000	15.875 0.6250	216000 48600	0.44	1.36	56000 12600	42400 9530	1.32	319000 71600	598	592-B
92.075 3.6250	149.225 5.8750	12.700 0.5000	163000 36600	0.49	1.22	42200 9490	35600 8000	1.19	241000 54300	42362	42587-B
92.075 3.6250	142.875 5.6250	15.080 0.5937	197000 44300	0.45	1.34	51100 11500	39200 8810	1.30	307000 69000	47890	47825-B
93.662 3.6875	152.400 6.0000	15.875 0.6250	216000 48600	0.44	1.36	56000 12600	42400 9530	1.32	319000 71600	597	592-B
93.662 3.6875	149.225 5.8750	12.700 0.5000	193000 43400	0.49	1.22	50100 11300	42200 9480	1.19	241000 54300	42368	42587-B
95.250 3.7500	190.500 7.5000	22.225 0.8750	458000 103000	0.33	1.79	119000 26700	68000 15300	1.74	630000 142000	864	854-B
95.250 3.7500	190.500 7.5000	22.225 0.8750	534000 120000	0.33	1.79	138000 31100	79300 17800	1.74	692000 156000	HH221440	HH221410-B
95.250 3.7500	180.975 7.1250	17.462 0.6875	346000 77800	0.39	1.56	89700 20200	59200 13300	1.51	495000 111000	776	772-B
95.250 3.7500	180.975 7.1250	17.462 0.6875	346000 77800	0.39	1.56	89700 20200	59200 13300	1.51	495000 111000	777	772-B
95.250 3.7500	171.450 6.7500	17.462 0.6875	403000 90500	0.37	1.63	104000 23500	65600 14700	1.59	474000 107000	77375	77675-B
95.250 3.7500	168.275 6.6250	18.255 0.7187	265000 59500	0.47	1.28	68600 15400	55300 12400	1.24	386000 86700	683	672-B
95.250 3.7500	161.925 6.3750	16.667 0.6562	223000 50200	0.47	1.26	57900 13000	47100 10600	1.23	343000 77000	52375	52637-B
95.250 3.7500	160.000 6.2992	16.667 0.6562	223000 50200	0.47	1.26	57900 13000	47100 10600	1.23	343000 77000	52375	52630XB
95.250 3.7500	152.400 6.0000	15.875 0.6250	216000 48600	0.44	1.36	56000 12600	42400 9530	1.32	319000 71600	594	592-B
95.250 3.7500	149.225 5.8750	12.700 0.5000	193000 43400	0.49	1.22	50100 11300	42200 9480	1.19	241000 54300	42375	42587-B

⁽¹⁾Based on 1×10^6 revolutions L_{10} life, for the ISO life-calculation method.

⁽²⁾Consult your Timken engineer for instructions on use or review the Timken Engineering Manual on timken.com/catalogs.

⁽³⁾Based on 90×10^6 revolutions L_{10} life, for The Timken Company life-calculation method. C_{90} and C_{a90} are radial and thrust values.

Bearing Dimensions									Geometry Factors			Bearing Weight
Width B	Width C	Eff. Ctr. a ⁽⁴⁾	Outer Ring Flange O.D. D ₁	Flange Width C ₂	Shaft			Housing	G ₁	G ₂	C _g	
					Max Shaft Fillet Radius R ⁽⁵⁾	Backing Shoulder Dia.		Backing Shoulder Dia. D _a				
mm in.	mm in.	mm in.	mm in.	mm in.	mm in.	mm in.	mm in.	mm in.				kg lbs.
48.260 1.9000	38.100 1.5000	-11.9 -0.47	169.748 6.6830	7.925 0.3120	3.5 0.14	101.0 3.98	110.0 4.33	150.0 5.91	177.2	29.4	0.0945	4.13 9.10
41.275 1.6250	30.162 1.1875	-2.8 -0.11	175.336 6.9030	7.142 0.2812	3.5 0.14	104.0 4.09	110.0 4.33	160.0 6.30	182.5	37.3	0.1056	3.94 8.70
36.322 1.4300	30.162 1.1875	-2.5 -0.10	158.648 6.2460	6.350 0.2500	3.5 0.14	101.0 3.98	107.0 4.21	144.0 5.67	151.4	38.3	0.1416	2.69 5.93
28.971 1.1406	24.608 0.9688	3.0 0.12	154.681 6.0898	5.558 0.2188	3.5 0.14	101.0 3.98	107.0 4.21	152.0 5.98	129.7	37.2	0.1386	2.04 4.48
34.925 1.3750	26.195 1.0313	-1.0 -0.04	149.123 5.8710	7.938 0.3125	3.5 0.14	101.0 3.98	107.0 4.21	142.0 5.59	153.2	38.1	0.1428	2.01 4.43
36.322 1.4300	30.162 1.1875	-2.5 -0.10	158.648 6.2460	6.350 0.2500	3.5 0.14	102.0 4.02	109.0 4.29	144.0 5.67	151.4	38.3	0.1416	2.62 5.78
28.971 1.1406	24.608 0.9688	3.0 0.12	154.681 6.0898	5.558 0.2188	3.0 0.12	102.0 4.02	107.0 4.21	152.0 5.98	129.7	37.2	0.1386	1.99 4.38
57.531 2.2650	44.450 1.7500	-15.2 -0.60	199.923 7.8710	9.525 0.3750	8.0 0.31	108.0 4.25	123.0 4.84	174.0 6.85	264.1	44.9	0.1072	7.46 16.46
57.531 2.2650	46.038 1.8125	-15.0 -0.59	199.923 7.8710	11.112 0.4375	8.0 0.31	110.0 4.33	125.0 4.92	179.0 7.05	265.6	28.4	0.1072	7.63 16.80
48.006 1.8900	38.100 1.5000	-8.1 -0.32	188.798 7.4330	7.938 0.3125	3.5 0.14	107.0 4.21	114.0 4.49	168.0 6.61	227.3	41.3	0.1067	5.55 12.23
48.006 1.8900	38.100 1.5000	-8.1 -0.32	188.798 7.4330	7.938 0.3125	9.7 0.38	107.0 4.21	126.0 4.96	168.0 6.61	227.3	41.3	0.1067	5.45 12.02
48.260 1.9000	38.100 1.5000	-9.7 -0.38	179.283 7.0584	7.938 0.3125	3.5 0.14	106.0 4.17	113.0 4.45	161.0 6.34	206.2	37.7	0.1017	4.72 10.40
41.275 1.6250	30.162 1.1875	-2.8 -0.11	175.336 6.9030	7.142 0.2812	3.5 0.14	106.0 4.17	113.0 4.45	160.0 6.30	182.5	37.3	0.1056	3.79 8.36
36.116 1.4219	26.195 1.0313	-0.5 -0.02	168.173 6.6210	6.350 0.2500	3.5 0.14	105.0 4.13	112.0 4.41	155.0 6.10	175.4	41.7	0.1519	2.99 6.59
36.116 1.4219	26.195 1.0313	-0.5 -0.02	166.345 6.5490	6.350 0.2500	3.5 0.14	105.0 4.13	112.0 4.41	155.0 6.10	175.4	41.7	0.1519	2.91 6.41
36.322 1.4300	30.162 1.1875	-2.5 -0.10	158.648 6.2460	6.350 0.2500	3.5 0.14	104.0 4.09	110.0 4.33	144.0 5.67	151.4	38.3	0.1416	2.56 5.63
28.971 1.1406	24.608 0.9688	3.0 0.12	154.681 6.0898	5.558 0.2188	3.0 0.12	103.0 4.06	108.0 4.25	152.0 5.98	129.7	37.2	0.1386	1.94 4.28

⁽⁴⁾Negative value indicates effective center inside cone (inner-ring) backface.

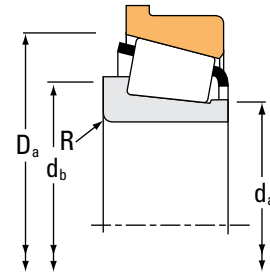
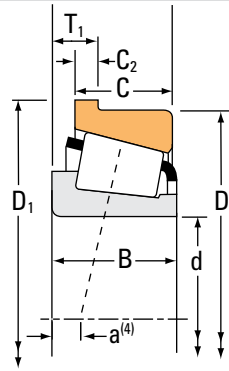
⁽⁵⁾These maximum fillet radii will be cleared by the bearing corners.

Continued on next page.

TAPERED ROLLER BEARINGS

SINGLE-ROW • TYPE TSF

TYPE TSF



Bearing Dimensions			Load Ratings							Part Number			
Bore d	O.D. D	Width T ₁	Dynamic ⁽¹⁾		Factors ⁽²⁾		Dynamic ⁽³⁾		Factors ⁽²⁾		Static C ₀	Inner	Outer
			C ₁	e	Y	C ₉₀	C _{a90}	K	N	N			
mm in.	mm in.	mm in.	N lbf			N lbf	N lbf		N lbf				
95.250 3.7500	142.875 5.6250	15.080 0.5937	197000 44300	0.45	1.34	51100 11500	39200 8810	1.30	307000 69000		47896	47825-B	
96.838 3.8125	149.225 5.8750	12.700 0.5000	193000 43400	0.49	1.22	50100 11300	42200 9480	1.19	241000 54300		42381	42587-B	
98.425 3.8750	212.725 8.3750	23.812 0.9375	680000 153000	0.33	1.84	176000 39600	98300 22100	1.79	906000 204000		HH224332	HH224310-B	
98.425 3.8750	190.500 7.5000	22.225 0.8750	534000 120000	0.33	1.79	138000 31100	79300 17800	1.74	692000 156000		HH221442	HH221410-B	
98.425 3.8750	180.975 7.1250	17.462 0.6875	346000 77800	0.39	1.56	89700 20200	59200 13300	1.51	495000 111000		779	772-B	
98.425 3.8750	168.275 6.6250	18.255 0.7187	265000 59500	0.47	1.28	68600 15400	55300 12400	1.24	386000 86700		685	672-B	
98.425 3.8750	161.925 6.3750	16.667 0.6562	223000 50200	0.47	1.26	57900 13000	47100 10600	1.23	343000 77000		52387	52637-B	
99.982 3.9363	190.500 7.5000	22.225 0.8750	534000 120000	0.33	1.79	138000 31100	79300 17800	1.74	692000 156000		HH221447	HH221410-B	
100.000 3.9370	180.975 7.1250	17.462 0.6875	346000 77800	0.39	1.56	89700 20200	59200 13300	1.51	495000 111000		783	772-B	
100.000 3.9370	145.000 5.7087	10.500 0.4134	125000 28200	0.47	1.27	32500 7310	26300 5920	1.24	172000 38700		JP10049	JP10010-B	
101.600 4.0000	212.725 8.3750	23.812 0.9375	572000 129000	0.33	1.84	148000 33300	82700 18600	1.79	786000 177000		941	932-B	
101.600 4.0000	200.000 7.8740	27.361 1.0772	482000 108000	0.63	0.95	125000 28100	135000 30400	0.92	519000 117000		98400	98788-B	
101.600 4.0000	190.500 7.5000	22.225 0.8750	458000 103000	0.33	1.79	119000 26700	68000 15300	1.74	630000 142000		861	854-B	
101.600 4.0000	190.500 7.5000	22.225 0.8750	534000 120000	0.33	1.79	138000 31100	79300 17800	1.74	692000 156000		HH221449	HH221410-B	
101.600 4.0000	180.975 7.1250	17.462 0.6875	346000 77800	0.39	1.56	89700 20200	59200 13300	1.51	495000 111000		780	772-B	
101.600 4.0000	168.275 6.6250	18.255 0.7187	265000 59500	0.47	1.28	68600 15400	55300 12400	1.24	386000 86700		687	672-B	
101.600 4.0000	161.925 6.3750	16.667 0.6562	223000 50200	0.47	1.26	57900 13000	47100 10600	1.23	343000 77000		52400	52637-B	

⁽¹⁾Based on 1×10^6 revolutions L_{10} life, for the ISO life-calculation method.

⁽²⁾Consult your Timken engineer for instructions on use or review the Timken Engineering Manual on timken.com/catalogs.

⁽³⁾Based on 90×10^6 revolutions L_{10} life, for The Timken Company life-calculation method. C_{90} and C_{a90} are radial and thrust values.

Bearing Dimensions									Geometry Factors			Bearing Weight
Width B	Width C	Eff. Ctr. a ⁽⁴⁾	Outer Ring Flange O.D. D ₁	Flange Width C ₂	Shaft			Housing	G ₁	G ₂	C _g	
					Max Shaft Fillet Radius R ⁽⁵⁾	Backing Shoulder Dia.		Backing Shoulder Dia. D _a				
mm in.	mm in.	mm in.	mm in.	mm in.	mm in.	mm in.	mm in.	mm in.				kg lbs.
34.925 1.3750	26.195 1.0313	-1.0 -0.04	149.123 5.8710	7.938 0.3125	3.5 0.14	103.0 4.06	110.0 4.33	142.0 5.59	153.2	38.1	0.1428	1.89 4.14
28.971 1.1406	24.608 0.9688	3.0 0.12	154.681 6.0898	5.558 0.2188	3.5 0.14	105.0 4.13	112.0 4.41	152.0 5.98	129.7	37.2	0.1386	1.88 4.15
66.675 2.6250	53.975 2.1250	-18.8 -0.74	223.733 8.8084	11.112 0.4375	3.5 0.14	119.0 4.69	123.0 4.84	204.0 8.03	366.6	47.9	0.1182	12.45 27.43
57.531 2.2650	46.038 1.8125	-15.0 -0.59	199.923 7.8710	11.112 0.4375	3.5 0.14	113.0 4.45	119.0 4.69	179.0 7.05	265.6	28.4	0.1072	7.47 16.46
48.006 1.8900	38.100 1.5000	-8.1 -0.32	188.798 7.4330	7.938 0.3125	3.5 0.14	110.0 4.33	116.0 4.57	168.0 6.61	227.3	41.3	0.1067	5.37 11.83
41.275 1.6250	30.162 1.1875	-2.8 -0.11	175.336 6.9030	7.142 0.2812	3.5 0.14	109.0 4.29	116.0 4.57	160.0 6.30	182.5	37.3	0.1056	3.64 8.02
36.116 1.4219	26.195 1.0313	-0.5 -0.02	168.173 6.6210	6.350 0.2500	3.5 0.14	108.0 4.25	114.0 4.49	155.0 6.10	175.4	41.7	0.1519	2.85 6.28
57.531 2.2650	46.038 1.8125	-15.0 -0.59	199.923 7.8710	11.112 0.4375	6.4 0.25	114.0 4.49	126.0 4.96	179.0 7.05	265.6	28.4	0.1072	7.33 16.14
48.006 1.8900	38.100 1.5000	-8.1 -0.32	188.798 7.4330	7.938 0.3125	3.5 0.14	111.0 4.37	118.0 4.65	168.0 6.61	227.3	41.3	0.1067	5.28 11.63
22.500 0.8858	17.500 0.6890	6.1 0.24	152.000 5.9843	4.000 0.1575	3.0 0.12	106.0 4.17	112.0 4.41	142.0 5.59	104.0	40.9	0.1264	1.19 2.61
66.675 2.6250	53.975 2.1250	-19.8 -0.78	223.736 8.8085	11.112 0.4375	7.0 0.28	117.0 4.61	130.0 5.12	199.0 7.83	338.6	39.8	0.1153	11.33 24.96
49.212 1.9375	34.925 1.3750	1.3 0.05	209.550 8.2500	9.525 0.3750	3.5 0.14	120.6 4.75	128.0 5.04	188.0 7.40	203.4	37.5	0.1197	6.98 15.40
57.531 2.2650	44.450 1.7500	-15.2 -0.60	199.923 7.8710	9.525 0.3750	8.0 0.31	114.0 4.49	129.0 5.08	174.0 6.85	264.1	44.9	0.1072	7.06 15.58
57.531 2.2650	46.038 1.8125	-15.0 -0.59	199.923 7.8710	11.112 0.4375	8.0 0.31	115.9 4.56	131.0 5.16	179.0 7.05	265.6	28.4	0.1072	7.22 15.91
48.006 1.8900	38.100 1.5000	-8.1 -0.32	188.798 7.4330	7.938 0.3125	3.5 0.14	113.0 4.45	119.0 4.69	168.0 6.61	227.3	41.3	0.1067	5.18 11.42
41.275 1.6250	30.162 1.1875	-2.8 -0.11	175.336 6.9030	7.142 0.2812	3.5 0.14	112.0 4.41	118.0 4.65	160.0 6.30	182.5	37.3	0.1056	3.47 7.66
36.116 1.4219	26.195 1.0313	-0.5 -0.02	168.173 6.6210	6.350 0.2500	3.5 0.14	111.0 4.37	117.0 4.61	155.0 6.10	175.4	41.7	0.1519	2.72 5.99

⁽⁴⁾Negative value indicates effective center inside cone (inner-ring) backface.

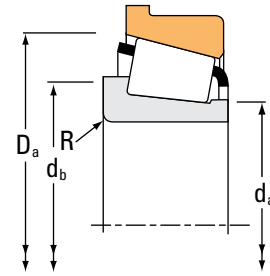
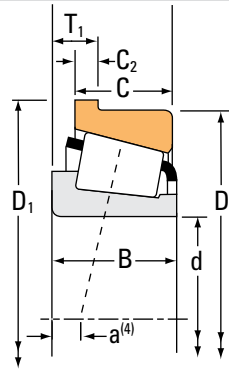
⁽⁵⁾These maximum fillet radii will be cleared by the bearing corners.

Continued on next page.

TAPERED ROLLER BEARINGS

SINGLE-ROW • TYPE TSF

TYPE TSF



Bearing Dimensions			Load Ratings							Part Number		
Bore d	O.D. D	Width T ₁	Dynamic ⁽¹⁾		Factors ⁽²⁾		Dynamic ⁽³⁾		Factors ⁽²⁾	Static	Inner	Outer
			C ₁	e	Y	C ₉₀	C _{a90}	K	C ₀			
mm in.	mm in.	mm in.	N lbf			N lbf	N lbf		N lbf			
101.600 4.0000	160.000 6.2992	16.667 0.6562	223000 50200	0.47	1.26	57900 13000	47100 10600	1.23	343000 77000		52400	52630XB
101.600 4.0000	157.162 6.1875	16.667 0.6562	223000 50200	0.47	1.26	57900 13000	47100 10600	1.23	343000 77000		52400	52618-B
104.775 4.1250	190.500 7.5000	20.638 0.8125	364000 81700	0.42	1.44	94300 21200	67100 15100	1.40	543000 122000		71412	71750-B
104.775 4.1250	180.975 7.1250	17.462 0.6875	346000 77800	0.39	1.56	89700 20200	59200 13300	1.51	495000 111000		782	772-B
107.950 4.2500	212.725 8.3750	23.812 0.9375	572000 129000	0.33	1.84	148000 33300	82700 18600	1.79	786000 177000		936	932-B
107.950 4.2500	212.725 8.3750	23.812 0.9375	680000 153000	0.33	1.84	176000 39600	98300 22100	1.79	906000 204000		HH224340	HH224310-B
107.950 4.2500	190.500 7.5000	20.638 0.8125	364000 81700	0.42	1.44	94300 21200	67100 15100	1.40	543000 122000		71425	71750-B
107.950 4.2500	165.100 6.5000	15.875 0.6250	226000 50900	0.50	1.21	58700 13200	50000 11200	1.18	355000 79700		56425	56650-B
109.538 4.3125	158.750 6.2500	11.908 0.4688	115000 25900	0.61	0.99	29900 6710	31000 6960	0.96	179000 40100		37431	37625-B
109.992 4.3304	177.800 7.0000	18.258 0.7188	275000 61800	0.52	1.16	71200 16000	62900 14100	1.13	419000 94200		64433	64700-B
111.125 4.3750	190.500 7.5000	20.638 0.8125	364000 81700	0.42	1.44	94300 21200	67100 15100	1.40	543000 122000		71437	71750-B
114.300 4.5000	212.725 8.3750	23.812 0.9375	572000 129000	0.33	1.84	148000 33300	82700 18600	1.79	786000 177000		938	932-B
114.300 4.5000	190.500 7.5000	20.638 0.8125	364000 81700	0.42	1.44	94300 21200	67100 15100	1.40	543000 122000		71450	71750-B
114.300 4.5000	177.800 7.0000	18.258 0.7188	275000 61800	0.52	1.16	71200 16000	62900 14100	1.13	419000 94200		64450	64700-B
115.000 4.5276	165.000 6.4961	12.500 0.4921	160000 35900	0.46	1.31	41400 9310	32500 7310	1.27	245000 55100		JLM722948	JLM722912-B
117.475 4.6250	180.975 7.1250	16.667 0.6562	232000 52100	0.50	1.21	60100 13500	51100 11500	1.18	271000 61000		68462	68712-B
120.000 4.7244	180.000 7.0866	16.350 0.6437	247000 55500	0.41	1.45	64000 14400	45300 10200	1.41	377000 84700		JM624649	JM624610-B

⁽¹⁾Based on 1×10^6 revolutions L_{10} life, for the ISO life-calculation method.

⁽²⁾Consult your Timken engineer for instructions on use or review the Timken Engineering Manual on timken.com/catalogs.

⁽³⁾Based on 90×10^6 revolutions L_{10} life, for The Timken Company life-calculation method. C_{90} and C_{a90} are radial and thrust values.

Bearing Dimensions									Geometry Factors			Bearing Weight
Width B	Width C	Eff. Ctr. a ⁽⁴⁾	Outer Ring Flange O.D. D ₁	Flange Width C ₂	Shaft			Housing	G ₁	G ₂	C _g	
					Max Shaft Fillet Radius R ⁽⁵⁾	Backing Shoulder Dia.		Backing Shoulder Dia. D _a				
mm in.	mm in.	mm in.	mm in.	mm in.	mm in.	mm in.	mm in.	mm in.				kg lbs.
36.116 1.4219	26.195 1.0313	-0.5 -0.02	166.345 6.5490	6.350 0.2500	3.5 0.14	111.0 4.37	117.0 4.61	155.0 6.10	175.4	41.7	0.1519	2.64 5.81
36.116 1.4219	26.195 1.0313	-0.5 -0.02	163.512 6.4375	6.350 0.2500	3.5 0.14	111.0 4.37	117.0 4.61	155.0 6.10	175.4	41.7	0.1519	2.47 5.44
49.212 1.9375	34.925 1.3750	-6.6 -0.26	198.323 7.8080	7.938 0.3125	3.5 0.14	118.0 4.65	124.0 4.88	181.0 7.13	269.2	49.5	0.1156	5.94 13.10
48.006 1.8900	38.100 1.5000	-8.1 -0.32	188.798 7.4330	7.938 0.3125	3.5 0.14	116.0 4.57	122.0 4.80	168.0 6.61	227.3	41.3	0.1067	4.99 10.99
66.675 2.6250	53.975 2.1250	-19.8 -0.78	223.736 8.8085	11.112 0.4375	8.0 0.31	122.0 4.80	137.0 5.39	199.0 7.83	338.6	39.8	0.1153	10.77 23.72
66.675 2.6250	53.975 2.1250	-18.8 -0.74	223.733 8.8084	11.112 0.4375	8.0 0.31	126.0 4.96	139.0 5.47	204.0 8.03	366.6	47.9	0.1182	11.57 25.50
49.212 1.9375	34.925 1.3750	-6.6 -0.26	198.323 7.8080	7.938 0.3125	3.6 0.14	120.0 4.72	126.0 4.96	181.0 7.13	269.2	49.5	0.1156	5.74 12.67
36.512 1.4375	26.988 1.0625	2.0 0.08	171.348 6.7460	6.350 0.2500	3.5 0.14	117.0 4.61	123.0 4.84	162.0 6.38	190.9	47.7	0.1584	2.74 6.03
21.438 0.8440	15.875 0.6250	13.7 0.54	163.413 6.4336	4.762 0.1875	3.5 0.14	116.0 4.57	123.0 4.84	153.0 6.02	123.7	57.1	0.1443	1.39 3.07
41.275 1.6250	30.162 1.1875	1.3 0.05	184.841 7.2772	7.145 0.2813	3.5 0.14	121.0 4.76	128.0 5.04	174.0 6.85	218.8	45.3	0.1153	3.92 8.65
49.212 1.9375	34.925 1.3750	-6.6 -0.26	198.323 7.8080	7.938 0.3125	3.6 0.14	123.0 4.84	129.0 5.08	181.0 7.13	269.2	49.5	0.1156	5.53 12.20
66.675 2.6250	53.975 2.1250	-19.8 -0.78	223.736 8.8085	11.112 0.4375	7.0 0.28	128.0 5.04	141.0 5.55	199.0 7.83	338.6	39.8	0.1153	10.20 22.47
49.212 1.9375	34.925 1.3750	-6.6 -0.26	198.323 7.8080	7.938 0.3125	3.6 0.14	125.0 4.92	132.0 5.20	181.0 7.13	269.2	49.5	0.1156	5.32 11.73
41.275 1.6250	30.162 1.1875	1.3 0.05	184.841 7.2772	7.145 0.2813	3.5 0.14	125.0 4.92	131.0 5.16	174.0 6.85	218.8	45.3	0.1153	3.67 8.11
27.000 1.0630	21.000 0.8268	5.6 0.22	172.000 6.7717	5.500 0.2165	3.3 0.13	121.0 4.76	127.0 5.00	160.0 6.30	161.0	57.2	0.1449	1.83 4.03
31.750 1.2500	25.400 1.0000	5.3 0.21	188.016 7.4022	7.145 0.2813	3.5 0.14	125.0 4.92	132.0 5.20	172.0 6.77	163.1	51.7	0.1026	2.87 6.33
36.000 1.4173	26.000 1.0236	0.0 0.00	188.000 7.4016	6.580 0.2590	3.5 0.14	128.0 5.04	135.0 5.31	175.0 6.89	226.8	61.6	0.1084	3.04 6.70

⁽⁴⁾Negative value indicates effective center inside cone (inner-ring) backface.

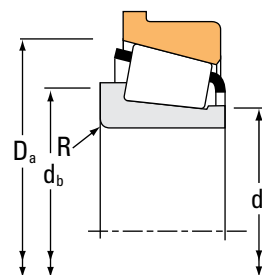
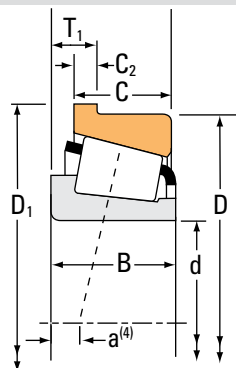
⁽⁵⁾These maximum fillet radii will be cleared by the bearing corners.

Continued on next page.

TAPERED ROLLER BEARINGS

SINGLE-ROW • TYPE TSF

TYPE TSF



Bearing Dimensions			Load Ratings							Part Number		
Bore d	O.D. D	Width T ₁	Dynamic ⁽¹⁾		Factors ⁽²⁾		Dynamic ⁽³⁾		Factors ⁽²⁾	Static C ₀	Inner	Outer
			C ₁	e	Y	C ₉₀	C _{a90}	K	C ₀			
mm in.	mm in.	mm in.	N lbf			N lbf	N lbf		N lbf			
120.650 4.7500	234.950 9.2500	25.400 1.0000	629000 141000	0.37	1.62	163000 36700	103000 23200	1.58	931000 209000		95475	95925-B
120.650 4.7500	160.338 6.3125	8.733 0.3438	97500 21900	0.43	1.38	25300 5680	18800 4230	1.34	206000 46400		L624549	L624510-B
123.825 4.8750	182.562 7.1875	12.700 0.5000	268000 60200	0.31	1.97	69400 15600	36300 8160	1.91	493000 111000		48286	48220-B
127.000 5.0000	234.950 9.2500	25.400 1.0000	629000 141000	0.37	1.62	163000 36700	103000 23200	1.58	931000 209000		95500	95925-B
127.000 5.0000	215.900 8.5000	20.638 0.8125	382000 85900	0.49	1.23	99000 22300	82600 18600	1.20	614000 138000		74500	74850-B
127.000 5.0000	182.562 7.1875	12.700 0.5000	268000 60200	0.31	1.97	69400 15600	36300 8160	1.91	493000 111000		48290	48220-B
130.000 5.1181	185.000 7.2835	13.000 0.5118	196000 44000	0.47	1.27	50800 11400	41100 9250	1.24	283000 63600		JP13049	JP13010-B
130.175 5.1250	196.850 7.7500	15.083 0.5938	368000 82600	0.34	1.74	95300 21400	56100 12600	1.70	625000 141000		67389	67322-B
133.350 5.2500	234.950 9.2500	25.400 1.0000	629000 141000	0.37	1.62	163000 36700	103000 23200	1.58	931000 209000		95525	95925-B
133.350 5.2500	215.900 8.5000	20.638 0.8125	382000 85900	0.49	1.23	99000 22300	82600 18600	1.20	614000 138000		74525	74850-B
133.350 5.2500	190.500 7.5000	11.908 0.4688	283000 63600	0.32	1.87	73300 16500	40300 9060	1.82	542000 122000		48385	48320-B
136.525 5.3750	254.000 10.0000	30.162 1.1875	660000 148000	0.41	1.47	171000 38500	119000 26800	1.43	1030000 231000		99537	99100-B
136.525 5.3750	215.900 8.5000	20.638 0.8125	382000 85900	0.49	1.23	99000 22300	82600 18600	1.20	614000 138000		74537	74850-B
139.700 5.5000	254.000 10.0000	30.162 1.1875	660000 148000	0.41	1.47	171000 38500	119000 26800	1.43	1030000 231000		99550	99100-B
139.700 5.5000	241.300 9.5000	22.225 0.8750	597000 134000	0.32	1.88	155000 34800	84500 19000	1.83	932000 210000		HM231132	HM231115-B
139.700 5.5000	215.900 8.5000	20.638 0.8125	382000 85900	0.49	1.23	99000 22300	82600 18600	1.20	614000 138000		74550	74850-B
140.000 5.5118	195.000 7.6772	13.000 0.5118	203000 45700	0.50	1.19	52700 11800	45400 10200	1.16	304000 68400		JP14049	JP14010-B

⁽¹⁾Based on 1×10^6 revolutions L_{10} life, for the ISO life-calculation method.

⁽²⁾Consult your Timken engineer for instructions on use or review the Timken Engineering Manual on timken.com/catalogs.

⁽³⁾Based on 90×10^6 revolutions L_{10} life, for The Timken Company life-calculation method. C_{90} and C_{a90} are radial and thrust values.

Bearing Dimensions									Geometry Factors			Bearing Weight
Width B	Width C	Eff. Ctr. a ⁽⁴⁾	Outer Ring Flange O.D. D ₁	Flange Width C ₂	Shaft			Housing	G ₁	G ₂	C _g	
					Max Shaft Fillet Radius R ⁽⁵⁾	Backing Shoulder Dia.		Backing Shoulder Dia. D _a				
mm in.	mm in.	mm in.	mm in.	mm in.	mm in.	mm in.	mm in.	mm in.				kg lbs.
63.500 2.5000	49.212 1.9375	-14.0 -0.55	245.958 9.6834	11.112 0.4375	6.4 0.25	137.0 5.39	149.0 5.87	217.0 8.54	453.9	59.4	0.1323	12.91 28.47
21.433 0.8438	16.670 0.6563	8.4 0.33	164.203 6.4647	3.970 0.1563	1.5 0.06	127.0 5.00	129.0 5.08	157.0 6.18	195.2	139.1	0.1509	1.20 2.63
38.100 1.5000	33.338 1.3125	-5.6 -0.22	188.811 7.4335	6.350 0.2500	3.5 0.14	133.0 5.24	139.0 5.47	177.0 6.97	353.0	91.4	0.1138	3.61 7.96
63.500 2.5000	49.212 1.9375	-14.0 -0.55	245.958 9.6834	11.112 0.4375	6.4 0.25	142.0 5.59	154.0 6.06	217.0 8.54	453.9	59.4	0.1323	12.30 27.12
47.625 1.8750	34.925 1.3750	2.3 0.09	223.733 8.8084	7.938 0.3125	3.5 0.14	141.0 5.55	148.0 5.83	209.0 8.23	362.9	68.5	0.1338	7.12 15.71
38.100 1.5000	33.338 1.3125	-5.6 -0.22	188.811 7.4335	6.350 0.2500	3.5 0.14	135.0 5.31	141.0 5.55	177.0 6.97	353.0	91.4	0.1138	3.43 7.55
27.000 1.0630	21.000 0.8268	8.9 0.35	192.000 7.5591	5.000 0.1969	3.0 0.12	137.0 5.39	143.0 5.63	188.0 7.40	192.2	60.3	0.1064	2.24 4.95
46.038 1.8125	38.100 1.5000	-6.4 -0.25	203.891 8.0272	7.145 0.2813	3.5 0.14	141.0 5.55	147.0 5.79	191.0 7.52	383.7	70.1	0.1220	5.06 11.15
63.500 2.5000	49.212 1.9375	-14.0 -0.55	245.958 9.6834	11.112 0.4375	9.7 0.38	148.0 5.83	166.0 6.54	217.0 8.54	453.9	59.4	0.1323	11.56 25.49
47.625 1.8750	34.925 1.3750	2.3 0.09	223.733 8.8084	7.938 0.3125	3.5 0.14	146.0 5.75	152.0 5.98	209.0 8.23	362.9	68.5	0.1338	6.64 14.64
39.688 1.5625	33.338 1.3125	-4.1 -0.16	195.956 7.7148	5.558 0.2188	3.5 0.14	142.0 5.59	148.0 5.83	186.0 7.32	403.8	105.1	0.1209	3.61 7.94
66.675 2.6250	47.625 1.8750	-12.2 -0.48	264.973 10.4320	11.112 0.4375	7.0 0.28	156.0 6.14	167.0 6.57	238.0 9.37	555.5	73.5	0.1459	14.79 32.61
47.625 1.8750	34.925 1.3750	2.3 0.09	223.733 8.8084	7.938 0.3125	3.5 0.14	148.0 5.83	155.0 6.10	209.0 8.23	362.9	68.5	0.1338	6.39 14.09
66.675 2.6250	47.625 1.8750	-12.2 -0.48	264.973 10.4320	11.112 0.4375	7.0 0.28	156.0 6.14	170.0 6.69	238.0 9.37	555.5	73.5	0.1459	14.40 31.76
56.642 2.2300	44.450 1.7500	-11.4 -0.45	250.723 9.8710	9.525 0.3750	3.5 0.14	156.0 6.14	160.0 6.30	224.0 8.82	532.8	85.9	0.1327	10.73 23.65
47.625 1.8750	34.925 1.3750	2.3 0.09	223.733 8.8084	7.938 0.3125	3.5 0.14	151.0 5.94	158.0 6.22	209.0 8.23	362.9	68.5	0.1338	6.13 13.52
27.000 1.0630	21.000 0.8268	11.9 0.47	202.000 7.9528	5.000 0.1969	3.0 0.12	148.0 5.83	153.0 6.02	198.0 7.80	219.5	68.2	0.1133	2.40 5.30

⁽⁴⁾Negative value indicates effective center inside cone (inner-ring) backface.

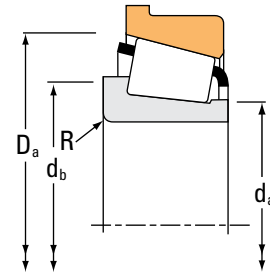
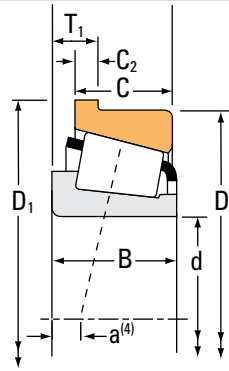
⁽⁵⁾These maximum fillet radii will be cleared by the bearing corners.

Continued on next page.

TAPERED ROLLER BEARINGS

SINGLE-ROW • TYPE TSF

TYPE TSF



Bearing Dimensions			Load Ratings							Part Number	
Bore d	O.D. D	Width T ₁	Dynamic ⁽¹⁾			Dynamic ⁽³⁾			Static C ₀	Inner	Outer
			C ₁	e	Y	C ₉₀	C _{a90}	K			
mm in.	mm in.	mm in.	N lbf			N lbf	N lbf		N lbf		
142.875 5.6250	241.300 9.5000	22.225 0.8750	597000 134000	0.32	1.88	155000 34800	84500 19000	1.83	932000 210000	HM231136	HM231115-B
142.875 5.6250	200.025 7.8750	12.700 0.5000	286000 64400	0.34	1.78	74300 16700	42800 9610	1.74	560000 126000	48685	48620-B
142.875 5.6250	193.675 7.6250	9.525 0.3750	196000 44200	0.37	1.63	50900 11400	32100 7220	1.59	394000 88600	36686	36620-B
146.050 5.7500	254.000 10.0000	30.162 1.1875	660000 148000	0.41	1.47	171000 38500	119000 26800	1.43	1030000 231000	99575	99100-B
146.050 5.7500	241.300 9.5000	22.225 0.8750	515000 116000	0.44	1.36	134000 30000	101000 22700	1.32	810000 182000	82576	82950-B
146.050 5.7500	241.300 9.5000	22.225 0.8750	597000 134000	0.32	1.88	155000 34800	84500 19000	1.83	932000 210000	HM231140	HM231115-B
146.050 5.7500	193.675 7.6250	9.525 0.3750	196000 44200	0.37	1.63	50900 11400	32100 7220	1.59	394000 88600	36690	36620-B
149.225 5.8750	254.000 10.0000	30.162 1.1875	660000 148000	0.41	1.47	171000 38500	119000 26800	1.43	1030000 231000	99587	99100-B
149.225 5.8750	241.300 9.5000	22.225 0.8750	597000 134000	0.32	1.88	155000 34800	84500 19000	1.83	932000 210000	HM231149	HM231115-B
150.000 5.9055	205.000 8.0709	12.000 0.4724	194000 43500	0.46	1.31	50200 11300	39400 8860	1.27	339000 76100	JL730646	JL730612-B
152.400 6.0000	254.000 10.0000	30.162 1.1875	660000 148000	0.41	1.47	171000 38500	119000 26800	1.43	1030000 231000	99600	99100-B
152.400 6.0000	192.088 7.5625	9.970 0.3925	143000 32000	0.42	1.44	37000 8310	26300 5920	1.40	277000 62200	L630349	L630310-B
158.750 6.2500	225.425 8.8750	13.495 0.5313	303000 68200	0.38	1.57	78600 17700	51600 11600	1.52	635000 143000	46780	46720-B
160.325 6.3120	288.925 11.3750	26.988 1.0625	976000 219000	0.32	1.88	253000 56900	138000 31100	1.83	1240000 278000	HM237532	HM237510-B
165.100 6.5000	254.000 10.0000	22.225 0.8750	498000 112000	0.37	1.62	129000 29000	81600 18300	1.58	644000 145000	86650	86100-B
165.100 6.5000	247.650 9.7500	16.670 0.6563	405000 91100	0.44	1.36	105000 23600	79000 17800	1.33	779000 175000	67780	67720-B
165.100 6.5000	225.425 8.8750	13.495 0.5313	303000 68200	0.38	1.57	78600 17700	51600 11600	1.52	635000 143000	46790	46720-B

⁽¹⁾Based on 1×10^6 revolutions L_{10} life, for the ISO life-calculation method.

⁽²⁾Consult your Timken engineer for instructions on use or review the Timken Engineering Manual on timken.com/catalogs.

⁽³⁾Based on 90×10^6 revolutions L_{10} life, for The Timken Company life-calculation method. C_{90} and C_{a90} are radial and thrust values.

Bearing Dimensions									Geometry Factors			Bearing Weight
Width B	Width C	Eff. Ctr. a ⁽⁴⁾	Outer Ring Flange O.D. D ₁	Flange Width C ₂	Shaft			Housing	G ₁	G ₂	C _g	
					Max Shaft Fillet Radius R ⁽⁵⁾	Backing Shoulder Dia.		Backing Shoulder Dia. D _a				
mm in.	mm in.	mm in.	mm in.	mm in.	mm in.	mm in.	mm in.	mm in.				kg lbs.
56.642 2.2300	44.450 1.7500	-11.4 -0.45	250.723 9.8710	9.525 0.3750	3.5 0.14	158.0 6.22	162.0 6.38	224.0 8.82	532.8	85.9	0.1327	10.42 22.96
39.688 1.5625	34.130 1.3437	-3.0 -0.12	205.481 8.0898	5.555 0.2187	3.5 0.14	151.0 5.94	158.0 6.22	194.0 7.64	439.6	130.5	0.1261	3.87 8.54
28.575 1.1250	23.020 0.9063	4.8 0.19	197.541 7.7772	3.970 0.1563	1.5 0.06	151.0 5.94	153.0 6.02	190.0 7.48	366.1	152.5	0.1768	2.46 5.42
66.675 2.6250	47.625 1.8750	-12.2 -0.48	264.973 10.4320	11.112 0.4375	7.0 0.28	162.0 6.38	175.0 6.89	238.0 9.37	555.5	73.5	0.1459	13.66 30.11
56.642 2.2300	44.450 1.7500	-3.6 -0.14	250.723 9.8710	9.525 0.3750	3.5 0.14	160.0 6.30	166.0 6.54	226.0 8.90	460.5	81.1	0.1405	10.33 22.77
56.642 2.2300	44.450 1.7500	-11.4 -0.45	250.723 9.8710	9.525 0.3750	3.5 0.14	160.0 6.30	164.0 6.46	224.0 8.82	532.8	85.9	0.1327	10.10 22.26
28.575 1.1250	23.020 0.9063	4.8 0.19	197.541 7.7772	3.970 0.1563	1.5 0.06	153.0 6.02	155.0 6.10	190.0 7.48	366.1	152.5	0.1768	2.30 5.07
66.675 2.6250	47.625 1.8750	-12.2 -0.48	264.973 10.4320	11.112 0.4375	7.0 0.28	170.0 6.69	181.0 7.13	238.0 9.37	555.5	73.5	0.1459	13.32 29.37
56.642 2.2300	44.450 1.7500	-11.4 -0.45	250.723 9.8710	9.525 0.3750	3.5 0.14	163.0 6.42	167.0 6.57	224.0 8.82	532.8	85.9	0.1327	9.77 21.54
28.575 1.1250	21.438 0.8440	11.4 0.45	210.000 8.2677	4.862 0.1914	3.3 0.13	158.0 6.22	164.0 6.46	200.0 7.87	295.2	103.6	0.1763	2.67 5.90
66.675 2.6250	47.625 1.8750	-12.2 -0.48	264.973 10.4320	11.112 0.4375	7.0 0.28	169.7 6.68	181.0 7.13	238.0 9.37	555.5	73.5	0.1459	12.87 28.39
24.000 0.9449	19.000 0.7480	10.2 0.40	197.371 7.7705	3.967 0.1562	2.0 0.08	158.0 6.22	162.0 6.38	190.0 7.48	293.3	163.8	0.1698	1.63 3.59
39.688 1.5625	33.338 1.3125	2.5 0.10	230.881 9.0898	5.558 0.2188	3.5 0.14	169.0 6.65	176.0 6.93	219.0 8.62	572.0	174.7	0.1432	5.18 11.45
63.500 2.5000	47.625 1.8750	-11.7 -0.46	299.933 11.8084	11.112 0.4375	7.0 0.28	181.0 7.13	192.0 7.56	279.0 10.98	751.2	101.5	0.1168	17.94 39.56
46.038 1.8125	33.338 1.3125	-1.5 -0.06	263.525 10.3750	9.525 0.3750	4.8 0.19	176.0 6.93	185.0 7.28	239.0 9.41	466.3	111.9	0.1041	7.99 17.62
47.625 1.8750	38.100 1.5000	4.8 0.19	254.691 10.0272	7.145 0.2813	3.5 0.14	179.0 7.05	185.0 7.28	241.0 9.49	622.3	122.6	0.1214	8.47 18.68
39.688 1.5625	33.338 1.3125	2.5 0.10	230.881 9.0898	5.558 0.2188	3.5 0.14	174.0 6.85	181.0 7.13	219.0 8.62	572.0	174.7	0.1432	4.67 10.31

⁽⁴⁾Negative value indicates effective center inside cone (inner-ring) backface.

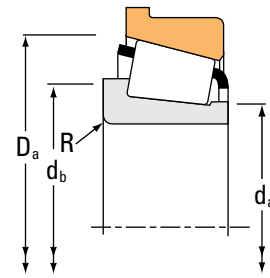
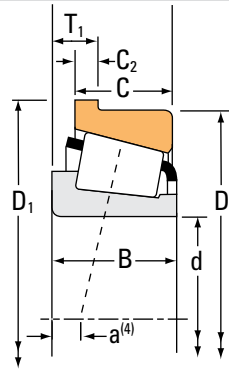
⁽⁵⁾These maximum fillet radii will be cleared by the bearing corners.

Continued on next page.

TAPERED ROLLER BEARINGS

SINGLE-ROW • TYPE TSF

TYPE TSF



Bearing Dimensions			Load Ratings							Part Number		
Bore d	O.D. D	Width T ₁	Dynamic ⁽¹⁾		Factors ⁽²⁾		Dynamic ⁽³⁾		Factors ⁽²⁾	Static C ₀	Inner	Outer
			C ₁	e	Y	C ₉₀	C _{a90}	K	C ₀			
mm in.	mm in.	mm in.	N lbf			N lbf	N lbf		N lbf			
171.450 6.7500	260.350 10.2500	25.400 1.0000	654000 147000	0.40	1.49	169000 38100	117000 26200	1.45	1180000 265000		HM535349	HM535310-B
174.625 6.8750	288.925 11.3750	26.988 1.0625	660000 148000	0.47	1.28	171000 38500	137000 30800	1.25	1070000 242000		94687	94113-B
174.625 6.8750	288.925 11.3750	26.988 1.0625	976000 219000	0.32	1.88	253000 56900	138000 31100	1.83	1240000 278000		HM237542	HM237510-B
177.800 7.0000	288.925 11.3750	26.988 1.0625	660000 148000	0.47	1.28	171000 38500	137000 30800	1.25	1070000 242000		94700	94113-B
177.800 7.0000	247.650 9.7500	16.670 0.6563	405000 91100	0.44	1.36	105000 23600	79000 17800	1.33	779000 175000		67790	67720-B
179.975 7.0856	317.500 12.5000	28.575 1.1250	731000 164000	0.52	1.15	190000 42600	170000 38200	1.12	1290000 290000		93708	93125-B
190.500 7.5000	317.500 12.5000	28.575 1.1250	731000 164000	0.52	1.15	190000 42600	170000 38200	1.12	1290000 290000		93750	93125-B
190.500 7.5000	266.700 10.5000	16.670 0.6563	416000 93600	0.48	1.26	108000 24300	88200 19800	1.22	835000 188000		67885	67820-B
193.675 7.6250	282.575 11.1250	23.812 0.9375	509000 114000	0.42	1.44	132000 29700	93900 21100	1.41	692000 156000		87762	87111-B
200.025 7.8750	317.500 12.5000	28.575 1.1250	731000 164000	0.52	1.15	190000 42600	170000 38200	1.12	1290000 290000		93787	93125-B
203.200 8.0000	317.500 12.5000	28.575 1.1250	731000 164000	0.52	1.15	190000 42600	170000 38200	1.12	1290000 290000		93800	93125-B
203.200 8.0000	282.575 11.1250	16.670 0.6563	503000 113000	0.51	1.18	130000 29300	114000 25500	1.15	876000 197000		67983	67920-B
206.375 8.1250	282.575 11.1250	16.670 0.6563	503000 113000	0.51	1.18	130000 29300	114000 25500	1.15	876000 197000		67985	67920-B
209.550 8.2500	317.500 12.5000	28.575 1.1250	731000 164000	0.52	1.15	190000 42600	170000 38200	1.12	1290000 290000		93825	93125-B
215.900 8.5000	406.400 16.0000	41.275 1.6250	1470000 331000	0.39	1.52	382000 85900	257000 57800	1.48	2250000 506000		EE820085	820160-B
215.900 8.5000	285.750 11.2500	19.050 0.7500	430000 96600	0.48	1.25	111000 25000	91800 20600	1.21	892000 200000		LM742749	LM742710-B
220.662 8.6875	314.325 12.3750	22.225 0.8750	695000 156000	0.33	1.80	180000 40500	103000 23100	1.76	1370000 308000		M244249	M244210-B

⁽¹⁾Based on 1 x 10⁶ revolutions L₁₀ life, for the ISO life-calculation method.

⁽²⁾Consult your Timken engineer for instructions on use or review the Timken Engineering Manual on timken.com/catalogs.

⁽³⁾Based on 90 x 10⁶ revolutions L₁₀ life, for The Timken Company life-calculation method. C₉₀ and C_{a90} are radial and thrust values.

Bearing Dimensions									Geometry Factors			Bearing Weight
Width B	Width C	Eff. Ctr. a ⁽⁴⁾	Outer Ring Flange O.D. D ₁	Flange Width C ₂	Shaft			Housing	G ₁	G ₂	C _g	
					Max Shaft Fillet Radius R ⁽⁵⁾	Backing Shoulder Dia. d _a	Backing Shoulder Dia. d _b	Backing Shoulder Dia. D _a				
mm in.	mm in.	mm in.	mm in.	mm in.	mm in.	mm in.	mm in.	mm in.				kg lbs.
66.675 2.6250	52.388 2.0625	-8.6 -0.34	271.374 10.6840	11.112 0.4375	3.5 0.14	186.1 7.40	192.0 7.56	250.0 9.84	749.5	115.6	0.1263	12.73 28.06
63.500 2.5000	47.625 1.8750	-0.8 -0.03	299.933 11.8084	11.112 0.4375	7.0 0.28	193.0 7.60	204.0 8.03	272.0 10.71	692.3	93.9	0.1287	16.39 36.12
63.500 2.5000	47.625 1.8750	-11.7 -0.46	299.933 11.8084	11.112 0.4375	7.0 0.28	191.0 7.52	202.0 7.95	279.0 10.98	751.2	101.5	0.1168	16.06 35.42
63.500 2.5000	47.625 1.8750	-0.8 -0.03	299.933 11.8084	11.112 0.4375	7.0 0.28	195.0 7.68	207.0 8.15	272.0 10.71	692.3	93.9	0.1287	16.01 35.30
47.625 1.8750	38.100 1.5000	4.8 0.19	254.691 10.0272	7.145 0.2813	3.5 0.14	188.0 7.40	194.0 7.64	241.0 9.49	622.3	122.6	0.1214	7.20 15.87
63.500 2.5000	46.038 1.8125	7.9 0.31	328.524 12.9340	11.112 0.4375	3.5 0.14	204.0 8.03	209.0 8.23	300.0 11.81	912.5	126.1	0.1460	21.71 47.87
63.500 2.5000	46.038 1.8125	7.9 0.31	328.524 12.9340	11.112 0.4375	4.3 0.17	212.0 8.35	218.0 8.58	300.0 11.81	912.5	126.1	0.1460	20.21 44.55
46.833 1.8438	38.100 1.5000	10.2 0.40	273.741 10.7772	7.145 0.2813	3.5 0.14	203.0 7.99	209.0 8.23	259.0 10.20	727.9	146.6	0.1310	8.08 17.82
47.625 1.8750	36.512 1.4375	3.8 0.15	291.998 11.4960	9.525 0.3750	3.5 0.14	206.0 8.11	211.0 8.31	272.0 10.71	574.6	130.8	0.1155	9.48 20.90
63.500 2.5000	46.038 1.8125	7.9 0.31	328.524 12.9340	11.112 0.4375	4.3 0.17	219.0 8.62	225.0 8.86	300.0 11.81	912.5	126.1	0.1460	18.75 41.34
63.500 2.5000	46.038 1.8125	7.9 0.31	328.524 12.9340	11.112 0.4375	4.3 0.17	222.0 8.74	227.0 8.94	300.0 11.81	912.5	126.1	0.1460	18.25 40.24
46.038 1.8125	36.512 1.4375	16.0 0.63	289.616 11.4022	7.145 0.2813	3.5 0.14	216.0 8.50	222.0 8.74	275.0 10.83	819.5	172.0	0.1388	8.81 19.44
46.038 1.8125	36.512 1.4375	16.0 0.63	289.616 11.4022	7.145 0.2813	3.5 0.14	219.0 8.62	224.0 8.82	275.0 10.83	819.5	172.0	0.1388	8.44 18.62
63.500 2.5000	46.038 1.8125	7.9 0.31	328.524 12.9340	11.112 0.4375	4.3 0.17	226.9 8.93	233.0 9.17	300.0 11.81	912.5	126.1	0.1460	17.23 37.98
93.662 3.6875	69.850 2.7500	-12.4 -0.49	425.450 16.7500	17.462 0.6875	6.4 0.25	241.0 9.49	251.0 9.88	385.1 15.16	1326.8	111.9	0.1509	53.70 118.42
46.038 1.8125	34.925 1.3750	14.2 0.56	293.685 11.5624	7.938 0.3125	3.5 0.14	227.0 8.94	233.0 9.17	280.0 11.02	866.9	225.2	0.1388	7.82 17.24
61.912 2.4375	49.212 1.9375	-4.6 -0.18	323.850 12.7500	9.525 0.3750	6.4 0.25	235.0 9.25	245.0 9.65	300.0 11.81	1149.7	141.4	0.1360	14.89 32.85

⁽⁴⁾Negative value indicates effective center inside cone (inner-ring) backface.

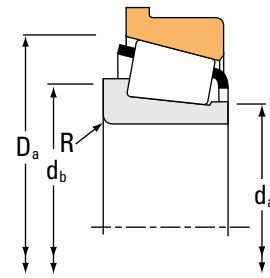
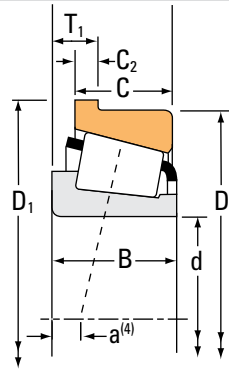
⁽⁵⁾These maximum fillet radii will be cleared by the bearing corners.

Continued on next page.

TAPERED ROLLER BEARINGS

SINGLE-ROW • TYPE TSF

TYPE TSF



Bearing Dimensions			Load Ratings							Part Number	
Bore d	O.D. D	Width T ₁	Dynamic ⁽¹⁾			Dynamic ⁽³⁾			Static C ₀	Inner	Outer
			C ₁	e	Y	C ₉₀	C _{a90}	K			
mm in.	mm in.	mm in.	N lbf			N lbf	N lbf		N lbf		
220.662 8.6875	314.325 12.3750	22.225 0.8750	649000 146000	0.33	1.80	168000 37800	95800 21500	1.76	1240000 279000	M244249A	M244210-B
228.600 9.0000	355.600 14.0000	31.750 1.2500	759000 171000	0.59	1.02	197000 44200	199000 44700	0.99	1420000 319000	96900	96140-B
228.600 9.0000	327.025 12.8750	25.400 1.0000	558000 126000	0.41	1.48	145000 32500	101000 22700	1.44	1070000 240000	8573	8520-B
234.950 9.2500	328.612 12.9375	26.988 1.0625	552000 124000	0.49	1.23	143000 32200	119000 26800	1.20	821000 185000	88925	88129-B
241.300 9.5000	368.300 14.5000	26.988 1.0625	844000 190000	0.34	1.75	219000 49200	129000 28900	1.70	1530000 345000	EE125095	125145-B
241.300 9.5000	327.025 12.8750	25.400 1.0000	527000 119000	0.41	1.48	137000 30700	95200 21400	1.44	1070000 240000	8578	8520-B
244.475 9.6250	381.000 15.0000	34.925 1.3750	907000 204000	0.52	1.16	235000 52900	208000 46800	1.13	1690000 381000	EE126097	126150-B
253.975 9.9990	330.000 12.9921	17.000 0.6693	360000 80800	0.56	1.07	93200 21000	89100 20000	1.05	715000 161000	L848849	JL848815-B
254.000 10.0000	403.225 15.8750	38.100 1.5000	1010000 228000	0.40	1.49	262000 59000	181000 40600	1.45	1600000 359000	EE275100	275158-B
254.000 10.0000	358.775 14.1250	30.162 1.1875	914000 206000	0.33	1.80	237000 53300	135000 30300	1.76	1850000 416000	M249749	M249710-B
254.000 10.0000	358.775 14.1250	30.162 1.1875	835000 188000	0.33	1.80	217000 48700	123000 27700	1.76	1630000 366000	M249749AH	M249711-B
254.000 10.0000	315.912 12.4375	14.526 0.5719	255000 57300	0.43	1.39	66100 14900	48700 10900	1.36	561000 126000	LL648449	LL648415-B
260.350 10.2500	400.050 15.7500	38.100 1.5000	949000 213000	0.39	1.52	246000 55300	166000 37400	1.48	1450000 326000	EE221026	221575-B
264.975 10.4321	349.948 13.7775	18.699 0.7362	333000 74900	0.54	1.11	86300 19400	79600 17900	1.08	750000 169000	L853042	L853011-B
266.700 10.5000	403.225 15.8750	38.100 1.5000	1010000 228000	0.40	1.49	262000 59000	181000 40600	1.45	1600000 359000	EE275105	275158-B
266.700 10.5000	355.600 14.0000	22.225 0.8750	880000 198000	0.36	1.67	228000 51300	141000 31600	1.62	1510000 339000	LM451349	LM451310-B
273.050 10.7500	403.225 15.8750	38.100 1.5000	1010000 228000	0.40	1.49	262000 59000	181000 40600	1.45	1600000 359000	EE275108	275158-B

⁽¹⁾Based on 1×10^6 revolutions L_{10} life, for the ISO life-calculation method.

⁽²⁾Consult your Timken engineer for instructions on use or review the Timken Engineering Manual on timken.com/catalogs.

⁽³⁾Based on 90×10^6 revolutions L_{10} life, for The Timken Company life-calculation method. C_{90} and C_{a90} are radial and thrust values.

Bearing Dimensions									Geometry Factors			Bearing Weight
Width B	Width C	Eff. Ctr. a ⁽⁴⁾	Outer Ring Flange O.D. D ₁	Flange Width C ₂	Shaft			Housing	G ₁	G ₂	C _g	
					Max Shaft Fillet Radius R ⁽⁵⁾	Backing Shoulder Dia.		Backing Shoulder Dia. D _a				
mm in.	mm in.	mm in.	mm in.	mm in.	mm in.	mm in.	mm in.	mm in.				kg lbs.
66.675 2.6250	49.212 1.9375	-4.6 -0.18	323.850 12.7500	9.525 0.3750	1.5 0.06	235.0 9.25	235.0 9.25	300.0 11.81	1073.1	132.4	0.1327	15.28 33.70
66.675 2.6250	47.625 1.8750	17.0 0.67	366.624 14.4340	11.112 0.4375	7.0 0.28	249.0 9.80	260.0 10.24	334.0 13.15	1140.0	160.6	0.1626	24.33 53.64
52.388 2.0625	36.512 1.4375	7.6 0.30	336.448 13.2460	9.525 0.3750	6.4 0.25	244.0 9.61	255.0 10.04	313.0 12.32	1050.5	172.4	0.1401	13.74 30.30
49.212 1.9375	34.925 1.3750	14.2 0.56	339.725 13.3750	9.525 0.3750	6.4 0.25	246.0 9.69	258.0 10.16	309.0 12.17	800.1	189.1	0.1352	11.83 26.09
68.262 2.6875	53.975 2.1250	-2.3 -0.09	380.898 14.9960	12.700 0.5000	6.4 0.25	257.0 10.12	269.0 10.59	354.1 13.94	1309.0	221.1	0.1432	24.83 54.75
52.388 2.0625	36.512 1.4375	7.6 0.30	336.448 13.2460	9.525 0.3750	6.4 0.25	253.0 9.96	264.0 10.39	313.0 12.32	1050.5	172.4	0.1401	11.81 26.05
76.200 3.0000	57.150 2.2500	9.7 0.38	393.598 15.4960	12.700 0.5000	6.4 0.25	266.0 10.47	275.0 10.83	358.0 14.09	1321.8	168.9	0.1640	31.90 70.32
41.500 1.6339	28.000 1.1024	32.0 1.26	342.000 13.4646	6.000 0.2362	1.5 0.06	266.0 10.47	266.0 10.47	320.0 12.60	868.9	255.1	0.1442	8.31 18.34
69.850 2.7500	46.038 1.8125	2.5 0.10	417.408 16.4334	14.288 0.5625	6.4 0.25	277.0 10.91	287.0 11.30	389.0 15.31	1451.8	201.3	0.1555	31.88 70.28
71.438 2.8125	53.975 2.1250	-6.9 -0.27	371.475 14.6250	12.700 0.5000	3.5 0.14	270.0 10.63	274.0 10.79	343.0 13.50	1626.0	173.0	0.1526	22.21 48.96
76.200 3.0000	53.975 2.1250	-6.9 -0.27	384.175 15.1250	12.700 0.5000	1.5 0.06	270.0 10.63	270.0 10.63	343.0 13.50	1485.4	158.7	0.1477	23.06 50.86
31.750 1.2500	22.225 0.8750	22.4 0.88	323.924 12.7529	5.001 0.1969	3.5 0.14	262.0 10.31	268.0 10.55	305.0 12.01	817.0	322.2	0.1295	5.03 11.09
67.470 2.6563	46.038 1.8125	0.8 0.03	414.233 16.3084	14.288 0.5625	9.7 0.38	280.0 11.02	296.0 11.65	383.0 15.08	1320.8	207.5	0.1497	27.98 61.69
34.925 1.3750	23.812 0.9375	35.1 1.38	357.950 14.0925	5.999 0.2362	3.5 0.14	280.0 11.02	285.0 11.22	342.0 13.46	1057.3	350.4	0.1517	8.89 19.61
69.850 2.7500	46.038 1.8125	2.5 0.10	417.408 16.4334	14.288 0.5625	6.4 0.25	287.0 11.30	296.0 11.65	389.0 15.31	1451.8	201.3	0.1555	29.03 64.01
57.150 2.2500	44.450 1.7500	5.1 0.20	365.125 14.3750	9.525 0.3750	3.5 0.14	281.0 11.06	285.0 11.22	344.0 13.54	1554.1	212.2	0.1536	15.69 34.61
69.850 2.7500	46.038 1.8125	2.5 0.10	417.408 16.4334	14.288 0.5625	6.4 0.25	291.0 11.46	301.0 11.85	389.0 15.31	1451.8	201.3	0.1555	27.65 60.95

⁽⁴⁾Negative value indicates effective center inside cone (inner-ring) backface.

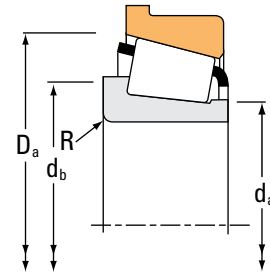
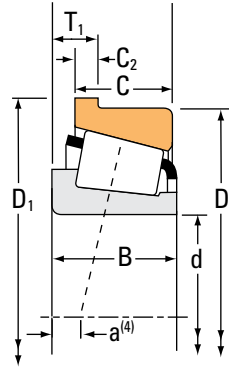
⁽⁵⁾These maximum fillet radii will be cleared by the bearing corners.

Continued on next page.

TAPERED ROLLER BEARINGS

SINGLE-ROW • TYPE TSF

TYPE TSF



Bearing Dimensions			Load Ratings							Part Number		
Bore d	O.D. D	Width T ₁	Dynamic ⁽¹⁾		Factors ⁽²⁾		Dynamic ⁽³⁾		Factors ⁽²⁾	Static	Inner	Outer
			C ₁	e	Y	C ₉₀	C _{a90}	K	C ₀			
mm in.	mm in.	mm in.	N lbf			N lbf	N lbf			N lbf		
276.225 10.8750	349.948 13.7775	18.699 0.7362	333000 74900	0.54	1.11	86300 19400	79600 17900	1.08		750000 169000	L853049	L853011-B
280.000 11.0236	406.400 16.0000	28.575 1.1250	924000 208000	0.39	1.55	240000 53900	158000 35600	1.51		1820000 409000	EE128114	128160-B
280.192 11.0312	406.400 16.0000	28.575 1.1250	868000 195000	0.39	1.55	225000 50600	149000 33400	1.51		1660000 374000	EE128111	128160-B
280.192 11.0312	406.400 16.0000	28.575 1.1250	924000 208000	0.39	1.55	240000 53900	158000 35600	1.51		1820000 409000	EE128110	128160-B
285.750 11.2500	380.898 14.9960	25.400 1.0000	722000 162000	0.43	1.39	187000 42100	138000 31100	1.35		1720000 387000	LM654649	LM654610-B
289.975 11.4163	404.950 15.9429	22.225 0.8750	586000 132000	0.36	1.67	152000 34200	93500 21000	1.63		1310000 295000	L357040	L357019-B
298.450 11.7500	444.500 17.5000	36.512 1.4375	887000 199000	0.38	1.59	230000 51700	149000 33400	1.55		1390000 312000	EE291175	291750-B
304.800 12.0000	444.500 17.5000	36.512 1.4375	887000 199000	0.38	1.59	230000 51700	149000 33400	1.55		1390000 312000	EE291201	291750-B
304.800 12.0000	406.400 16.0000	25.400 1.0000	769000 173000	0.44	1.36	199000 44800	151000 33900	1.32		1740000 392000	LM757049	LM757010-B
304.800 12.0000	404.950 15.9429	22.225 0.8750	586000 132000	0.36	1.67	152000 34200	93500 21000	1.63		1310000 295000	L357049	L357019-B
317.500 12.5000	444.500 17.5000	36.512 1.4375	887000 199000	0.38	1.59	230000 51700	149000 33400	1.55		1390000 312000	EE291250	291750-B
330.200 13.0000	482.600 19.0000	36.512 1.4375	1030000 231000	0.42	1.44	266000 59900	190000 42700	1.40		1770000 398000	EE203130	203190-B
330.200 13.0000	482.600 19.0000	41.275 1.6250	1250000 281000	0.39	1.54	324000 72900	217000 48700	1.49		2320000 523000	EE526130	526190-B
346.075 13.6250	482.600 19.0000	36.512 1.4375	1030000 231000	0.42	1.44	266000 59900	190000 42700	1.40		1770000 398000	EE203136	203190-B
349.250 13.7500	501.650 19.7500	34.925 1.3750	1350000 304000	0.37	1.63	350000 78700	220000 49500	1.59		2780000 626000	EE333137	333197-B
371.475 14.6250	508.000 20.0000	38.100 1.5000	1050000 236000	0.44	1.36	273000 61300	206000 46200	1.33		1870000 420000	EE231462	232000-B
374.650 14.7500	522.288 20.5625	38.100 1.5000	1390000 313000	0.39	1.56	360000 81000	238000 53500	1.51		2950000 663000	LM565943	LM565910-B

⁽¹⁾Based on 1 x 10⁶ revolutions L₁₀ life, for the ISO life-calculation method.

⁽²⁾Consult your Timken engineer for instructions on use or review the Timken Engineering Manual on timken.com/catalogs.

⁽³⁾Based on 90 x 10⁶ revolutions L₁₀ life, for The Timken Company life-calculation method. C₉₀ and C_{a90} are radial and thrust values.

Bearing Dimensions									Geometry Factors			Bearing Weight
Width B	Width C	Eff. Ctr. a ⁽⁴⁾	Outer Ring Flange O.D. D ₁	Flange Width C ₂	Shaft			Housing	G ₁	G ₂	C _g	
					Max Shaft Fillet Radius R ⁽⁵⁾	Backing Shoulder Dia. d _a	Backing Shoulder Dia. d _b	Backing Shoulder Dia. D _a				
mm in.	mm in.	mm in.	mm in.	mm in.	mm in.	mm in.	mm in.	mm in.				kg lbs.
34.925 1.3750	23.812 0.9375	35.1 1.38	357.950 14.0925	5.999 0.2362	3.5 0.14	288.0 11.34	293.0 11.54	342.0 13.46	1057.3	350.4	0.1517	7.61 16.78
67.673 2.6643	53.975 2.1250	6.6 0.26	418.998 16.4960	12.700 0.5000	6.4 0.25	307.0 12.09	308.0 12.13	384.0 15.12	1727.7	255.2	0.1628	29.02 64.00
67.673 2.6643	53.975 2.1250	6.6 0.26	418.998 16.4960	12.700 0.5000	6.8 0.27	307.0 12.09	309.0 12.17	384.0 15.12	1622.7	240.4	0.1592	27.99 61.73
67.673 2.6643	53.975 2.1250	6.6 0.26	418.998 16.4960	12.700 0.5000	6.8 0.27	307.0 12.09	309.0 12.17	384.0 15.12	1727.7	255.2	0.1628	28.95 63.85
65.088 2.5625	49.212 1.9375	11.4 0.45	390.423 15.3710	9.525 0.3750	3.5 0.14	302.0 11.89	306.0 12.05	368.0 14.49	1916.4	265.6	0.1744	20.07 44.22
50.800 2.0000	38.100 1.5000	12.7 0.50	419.923 16.5324	9.525 0.3750	6.4 0.25	308.0 12.13	318.0 12.52	380.0 14.96	1753.3	301.0	0.1585	20.08 44.25
61.912 2.4375	39.688 1.5625	7.6 0.30	457.098 17.9960	12.700 0.5000	8.0 0.31	320.0 12.60	332.0 13.07	428.0 16.85	1579.2	244.8	0.1557	30.48 67.19
61.912 2.4375	39.688 1.5625	7.6 0.30	457.098 17.9960	12.700 0.5000	8.0 0.31	324.0 12.76	337.0 13.27	428.0 16.85	1579.2	244.8	0.1557	29.02 63.97
63.500 2.5000	47.625 1.8750	16.3 0.64	419.100 16.5000	9.525 0.3750	6.4 0.25	322.0 12.68	331.0 13.03	393.0 15.47	1988.6	260.3	0.1775	22.05 48.61
50.800 2.0000	38.100 1.5000	12.7 0.50	419.923 16.5324	9.525 0.3750	6.4 0.25	319.0 12.56	329.0 12.95	380.0 14.96	1753.3	301.0	0.1585	17.32 38.17
61.912 2.4375	39.688 1.5625	7.6 0.30	457.098 17.9960	12.700 0.5000	8.0 0.31	334.0 13.15	346.0 13.62	428.0 16.85	1579.2	244.8	0.1557	26.00 57.32
63.500 2.5000	44.450 1.7500	16.3 0.64	496.788 19.5586	14.288 0.5625	6.8 0.27	354.0 13.94	364.0 14.33	466.0 18.35	2138.1	336.0	0.1778	37.38 82.39
80.167 3.1562	60.325 2.3750	4.8 0.19	498.373 19.6210	15.875 0.6250	6.4 0.25	351.0 13.82	360.0 14.17	464.0 18.27	2283.3	287.2	0.1790	46.63 102.79
63.500 2.5000	44.450 1.7500	16.3 0.64	496.788 19.5586	14.288 0.5625	6.8 0.27	366.0 14.41	376.0 14.80	466.0 18.35	2138.1	336.0	0.1778	33.18 73.14
84.138 3.3125	69.850 2.7500	3.6 0.14	515.838 20.3086	14.288 0.5625	6.4 0.25	372.0 14.65	382.0 15.04	486.0 19.13	3037.5	334.7	0.1928	54.36 119.85
66.675 2.6250	50.800 2.0000	19.6 0.77	522.188 20.5586	14.288 0.5625	6.4 0.25	390.0 15.35	400.0 15.75	489.0 19.25	2386.0	366.8	0.1874	37.37 82.40
84.138 3.3125	61.912 2.4375	8.9 0.35	536.476 21.1211	14.288 0.5625	6.4 0.25	397.0 15.63	407.0 16.02	507.0 19.96	3379.9	375.8	0.2028	52.86 116.53

⁽⁴⁾Negative value indicates effective center inside cone (inner-ring) backface.

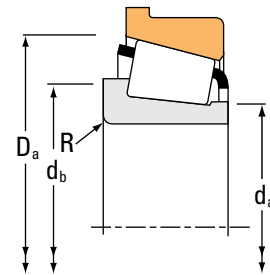
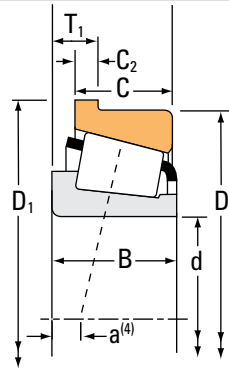
⁽⁵⁾These maximum fillet radii will be cleared by the bearing corners.

Continued on next page.

TAPERED ROLLER BEARINGS

SINGLE-ROW • TYPE TSF

TYPE TSF



Bearing Dimensions			Load Ratings							Part Number		
Bore d	O.D. D	Width T ₁	Dynamic ⁽¹⁾		Factors ⁽²⁾		Dynamic ⁽³⁾		Factors ⁽²⁾	Static	Inner	Outer
			C ₁	e	Y	C ₉₀	C _{a90}	K	C ₀			
mm in.	mm in.	mm in.	N lbf			N lbf	N lbf		N lbf			
377.825 14.8750	522.288 20.5625	38.100 1.5000	1390000 313000	0.39	1.56	360000 81000	238000 53500	1.51	2950000 663000		LM565946	LM565910-B
381.000 15.0000	522.288 20.5625	38.100 1.5000	1390000 313000	0.39	1.56	360000 81000	238000 53500	1.51	2950000 663000		LM565949	LM565910-B
381.000 15.0000	479.425 18.8750	23.812 0.9375	594000 133000	0.50	1.21	154000 34600	130000 29300	1.18	1380000 311000		L865547	L865512-B
396.875 15.6250	549.275 21.6250	38.100 1.5000	1430000 322000	0.41	1.47	371000 83500	259000 58200	1.43	3130000 704000		LM567943	LM567910-B
403.225 15.8750	460.375 18.1250	12.700 0.5000	230000 51700	0.40	1.49	59600 13400	41000 9210	1.45	708000 159000		LL566848	LL566810-B
406.400 16.0000	549.275 21.6250	38.100 1.5000	1430000 322000	0.41	1.47	371000 83500	259000 58200	1.43	3130000 704000		LM567949	LM567910-B
406.400 16.0000	508.000 20.0000	25.400 1.0000	859000 193000	0.37	1.64	223000 50100	139000 31300	1.60	2230000 502000		L467549	L467510-B
431.800 17.0000	533.400 21.0000	20.638 0.8125	624000 140000	0.31	1.96	162000 36400	84700 19000	1.91	1520000 342000		80385	80325-B
450.850 17.7500	603.250 23.7500	39.688 1.5625	1490000 335000	0.45	1.32	386000 86800	300000 67300	1.29	3440000 773000		LM770945	LM770910-B
457.200 18.0000	603.250 23.7500	39.688 1.5625	1490000 335000	0.45	1.32	386000 86800	300000 67300	1.29	3440000 773000		LM770949	LM770910-B
457.200 18.0000	596.900 23.5000	76.200 3.0000	1410000 318000	0.40	1.48	367000 82400	254000 57100	1.44	2890000 649000		EE244180	244235-B
482.600 19.0000	634.873 24.9950	31.750 1.2500	1470000 330000	0.34	1.75	380000 85500	223000 50200	1.70	3660000 822000		EE243190	243250-B
488.950 19.2500	660.400 26.0000	38.100 1.5000	2370000 533000	0.31	1.95	614000 138000	323000 72600	1.90	4590000 1030000		EE640192	640260-B
489.026 19.2530	634.873 24.9950	31.750 1.2500	1470000 330000	0.34	1.75	380000 85500	223000 50200	1.70	3660000 822000		EE243192	243250-B
498.475 19.6250	634.873 24.9950	31.750 1.2500	1470000 330000	0.34	1.75	380000 85500	223000 50200	1.70	3660000 822000		EE243196	243250-B
596.900 23.5000	685.800 27.0000	13.492 0.5312	344000 77300	0.53	1.14	89200 20000	80400 18100	1.11	963000 217000		680235	680270-B
647.700 25.5000	736.600 29.0000	13.495 0.5313	406000 91300	0.35	1.71	105000 23700	63200 14200	1.67	1170000 264000		LL380849	LL380810-B

⁽¹⁾Based on 1 x 10⁶ revolutions L₁₀ life, for the ISO life-calculation method.

⁽²⁾Consult your Timken engineer for instructions on use or review the Timken Engineering Manual on timken.com/catalogs.

⁽³⁾Based on 90 x 10⁶ revolutions L₁₀ life, for The Timken Company life-calculation method. C₉₀ and C_{a90} are radial and thrust values.

Bearing Dimensions									Geometry Factors			Bearing Weight
Width B	Width C	Eff. Ctr. a ⁽⁴⁾	Outer Ring Flange O.D. D ₁	Flange Width C ₂	Shaft			Housing	G ₁	G ₂	C _g	
					Max Shaft Fillet Radius R ⁽⁵⁾	Backing Shoulder Dia. d _a	Backing Shoulder Dia. d _b	Backing Shoulder Dia. D _a				
mm in.	mm in.	mm in.	mm in.	mm in.	mm in.	mm in.	mm in.	mm in.				kg lbs.
84.138 3.3125	61.912 2.4375	8.9 0.35	536.476 21.1211	14.288 0.5625	6.4 0.25	399.0 15.71	409.0 16.10	507.0 19.96	3379.9	375.8	0.2028	51.62 113.80
84.138 3.3125	61.912 2.4375	8.9 0.35	536.476 21.1211	14.288 0.5625	6.4 0.25	402.0 15.83	411.0 16.18	507.0 19.96	3379.9	375.8	0.2028	50.42 111.16
47.625 1.8750	34.925 1.3750	42.9 1.69	489.737 19.2810	9.525 0.3750	6.4 0.25	395.0 15.55	407.0 16.02	465.0 18.31	2256.6	529.8	0.1897	18.97 41.81
84.138 3.3125	61.912 2.4375	15.5 0.61	563.463 22.1836	14.288 0.5625	6.4 0.25	420.0 16.54	430.0 16.93	531.0 20.91	3796.2	424.8	0.2143	58.63 129.27
28.575 1.1250	22.225 0.8750	41.4 1.63	469.900 18.5000	6.350 0.2500	3.5 0.14	414.0 16.30	418.0 16.46	452.0 17.80	2302.0	1585.3	0.2225	7.00 15.44
84.138 3.3125	61.912 2.4375	15.5 0.61	563.463 22.1836	14.288 0.5625	6.4 0.25	427.0 16.81	437.0 17.20	531.0 20.91	3796.2	424.8	0.2143	54.17 119.42
61.912 2.4375	47.625 1.8750	20.3 0.80	519.013 20.4336	11.112 0.4375	3.3 0.13	423.0 16.65	426.0 16.77	492.0 19.37	3716.5	673.8	0.2038	27.95 61.62
46.038 1.8125	34.925 1.3750	23.4 0.92	542.925 21.3750	9.525 0.3750	3.3 0.13	446.0 17.56	450.0 17.72	510.0 20.08	3209.2	802.4	0.1815	21.04 46.37
84.138 3.3125	60.325 2.3750	30.5 1.20	617.438 24.3086	14.288 0.5625	6.4 0.25	474.0 18.66	484.0 19.06	579.7 22.82	4660.5	534.5	0.2366	65.09 143.51
84.138 3.3125	60.325 2.3750	30.5 1.20	617.438 24.3086	14.288 0.5625	6.4 0.25	479.0 18.86	489.0 19.25	579.7 22.82	4660.5	534.5	0.2366	61.09 134.69
73.025 2.8750	53.975 2.1250	26.7 1.05	611.200 24.0630	14.300 0.5630	9.7 0.38	478.0 18.82	494.0 19.45	570.0 22.47	4411.8	627.1	0.2233	51.04 112.51
80.962 3.1875	63.500 2.5000	19.1 0.75	649.199 25.5590	14.288 0.5625	6.4 0.25	510.0 20.08	516.0 20.31	618.0 24.33	6057.3	726.6	0.2350	67.90 149.71
94.458 3.7188	69.850 2.7500	4.8 0.19	676.275 26.6250	14.288 0.5625	6.4 0.25	513.0 20.20	522.0 20.55	642.0 25.28	6322.4	601.7	0.2310	90.10 198.61
80.962 3.1875	63.500 2.5000	19.1 0.75	649.199 25.5590	14.288 0.5625	6.4 0.25	516.0 20.31	522.0 20.55	618.0 24.33	6057.3	726.6	0.2350	64.58 142.37
80.962 3.1875	63.500 2.5000	19.1 0.75	649.199 25.5590	14.288 0.5625	6.4 0.25	522.0 20.55	528.0 20.79	618.0 24.33	6057.3	726.6	0.2350	60.14 132.60
31.750 1.2500	25.400 1.0000	96.0 3.78	692.841 27.2772	7.142 0.2812	3.5 0.14	615.0 24.21	615.0 24.21	669.0 26.34	3739.1	1810.4	0.2225	16.93 37.33
31.750 1.2500	25.400 1.0000	64.3 2.53	743.636 29.2770	7.145 0.2813	3.5 0.14	660.0 25.98	666.0 26.22	720.0 28.35	5165.7	2840.6	0.2172	19.15 42.21

⁽⁴⁾Negative value indicates effective center inside cone (inner-ring) backface.

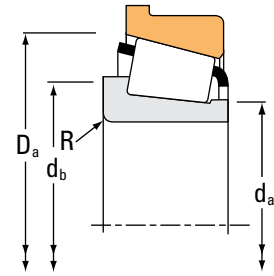
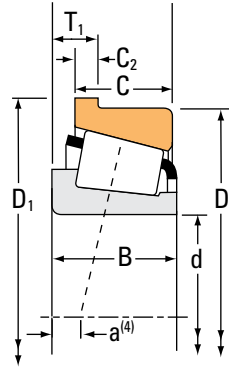
⁽⁵⁾These maximum fillet radii will be cleared by the bearing corners.

Continued on next page.

TAPERED ROLLER BEARINGS

SINGLE-ROW • TYPE TSF

TYPE TSF



Bearing Dimensions			Load Ratings							Part Number		
Bore d	O.D. D	Width T ₁	Dynamic ⁽¹⁾		Factors ⁽²⁾		Dynamic ⁽³⁾		Factors ⁽²⁾	Static	Inner	Outer
			C ₁	e	Y	C ₉₀	C _{a90}	K	C ₀			
mm in.	mm in.	mm in.	N lbf			N lbf	N lbf			N lbf		
736.600 29.0000	825.500 32.5000	12.700 0.5000	424000 95300	0.40	1.51	110000 24700	74800 16800	1.47		1300000 291000	LL582949	LL582910-B
1063.625 41.8750	1219.200 48.0000	34.925 1.3750	1720000 386000	0.48	1.26	445000 100000	362000 81400	1.23		5660000 1270000	LL788345	LL788310-B
1066.800 42.0000	1219.200 48.0000	34.925 1.3750	1720000 386000	0.48	1.26	445000 100000	362000 81400	1.23		5660000 1270000	LL788349	LL788310-B
1270.000 50.0000	1435.100 56.5000	36.512 1.4375	1840000 414000	0.57	1.05	478000 107000	467000 105000	1.02		6650000 1500000	LL889049	LL889010-B

⁽¹⁾Based on 1×10^6 revolutions L_{10} life, for the ISO life-calculation method.

⁽²⁾Consult your Timken engineer for instructions on use or review the Timken Engineering Manual on timken.com/catalogs.

⁽³⁾Based on 90×10^6 revolutions L_{10} life, for The Timken Company life-calculation method. C_{90} and C_{a90} are radial and thrust values.

Bearing Dimensions									Geometry Factors			Bearing Weight
Width B	Width C	Eff. Ctr. a ⁽⁴⁾	Outer Ring Flange O.D. D ₁	Flange Width C ₂	Shaft			Housing	G ₁	G ₂	C _g	
					Max Shaft Fillet Radius R ⁽⁵⁾	Backing Shoulder Dia.		Backing Shoulder Dia. D _a				
mm in.	mm in.	mm in.	mm in.	mm in.	mm in.	mm in.	mm in.	mm in.				kg lbs.
31.750 1.2500	25.400 1.0000	86.9 3.42	833.435 32.8124	6.350 0.2500	3.5 0.14	753.1 29.65	753.1 29.65	807.0 31.77	6526.9	3683.4	0.2436	21.01 46.30
65.088 2.5625	42.862 1.6875	142.5 5.61	1231.900 48.5000	12.700 0.5000	3.3 0.13	1085.0 42.72	1090.0 42.91	1200.0 47.24	22182.4	4652.2	0.3922	113.74 250.78
65.088 2.5625	42.862 1.6875	142.5 5.61	1231.900 48.5000	12.700 0.5000	3.3 0.13	1090.0 42.91	1090.0 42.91	1200.0 47.24	22182.4	4652.2	0.3922	111.04 244.81
65.088 2.5625	47.625 1.8750	216.9 8.54	1454.150 57.2500	14.288 0.5625	6.4 0.25	1300.0 51.18	1305.0 51.38	1415.0 55.71	31422.7	5654.9	0.4637	151.19 333.35

⁽⁴⁾Negative value indicates effective center inside cone (inner-ring) backface.

⁽⁵⁾These maximum fillet radii will be cleared by the bearing corners.

TYPE TSL

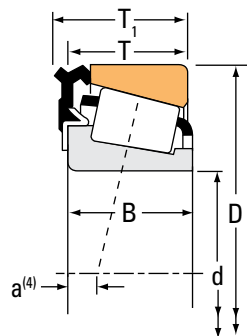
- TSL is a single-row bearing with a DUO-FACE PLUS seal pressed on to the large rib of the inner ring.
- One lip of the DUO-FACE PLUS seal operates in the housing bore, the other lip seals against the hardened and ground surface of the outer-ring front face.
- This bearing provides an effective means to integrate a seal into grease-lubricated applications operating at moderate speeds.
- Consult your Timken engineer before making a final bearing selection to help ensure suitability, availability and the most cost-effective application.



TAPERED ROLLER BEARINGS

SINGLE-ROW • TYPE TSL

TYPE TSL



Bearing Dimensions				Load Ratings							
Bore d	O.D. D	Width T	Width T ₁	Dynamic ⁽¹⁾		Factors ⁽²⁾		Dynamic ⁽³⁾		Factors ⁽²⁾	Static
				C ₁	e	Y	C ₉₀	C _{a90}	K	C ₀	
mm in.	mm in.	mm in.	mm in.	N lbf			N lbf	N lbf		N lbf	
19.050 0.7500	45.237 1.7810	15.494 0.6100	16.281 0.6410	39100 8800	0.30	2.00	10100 2280	5220 1170	1.94	32000 7200	
19.050 0.7500	45.237 1.7810	16.281 0.6410	17.400 0.6850	39100 8800	0.30	2.00	10100 2280	5220 1170	1.94	32000 7200	
21.430 0.8437	50.005 1.9687	18.313 0.7210	19.430 0.7650	52200 11700	0.28	2.16	13500 3040	6440 1450	2.10	43500 9780	
25.400 1.0000	50.005 1.9687	14.206 0.5593	15.400 0.6060	29100 6540	0.40	1.49	7550 1700	5190 1170	1.45	29600 6650	
25.400 1.0000	50.292 1.9800	14.224 0.5600	14.935 0.5880	35600 8010	0.37	1.60	9230 2080	5910 1330	1.56	32900 7400	
25.400 1.0000	50.292 1.9800	14.935 0.5880	16.130 0.6350	35600 8010	0.37	1.60	9230 2080	5910 1330	1.56	32900 7400	
25.400 1.0000	50.292 1.9800	14.935 0.5880	16.130 0.6350	35600 8010	0.37	1.60	9230 2080	5910 1330	1.56	32900 7400	
31.750 1.2500	59.131 2.3280	16.637 0.6550	17.780 0.7000	46700 10500	0.41	1.46	12100 2720	8550 1920	1.42	44600 10000	
34.925 1.3750	65.088 2.5625	18.796 0.7400	19.940 0.7850	64600 14500	0.38	1.59	16700 3760	10800 2430	1.55	63100 14200	
38.100 1.5000	65.088 2.5625	18.796 0.7400	19.940 0.7850	48600 10900	0.33	1.80	12600 2830	7170 1610	1.76	60300 13600	
38.100 1.5000	69.012 2.7170	19.050 0.7500	20.190 0.7950	67200 15100	0.40	1.49	17400 3920	12000 2700	1.45	67900 15300	
38.100 1.5000	69.012 2.7170	19.812 0.7800	20.960 0.8250	67200 15100	0.40	1.49	17400 3920	12000 2700	1.45	67900 15300	
63.500 2.5000	110.000 4.3307	23.218 0.9141	23.218 0.9141	98900 22200	0.40	1.49	25600 5760	17600 3970	1.45	125000 28100	
68.262 2.6875	110.000 4.3307	23.218 0.9141	24.640 0.9700	98900 22200	0.40	1.49	25600 5760	17600 3970	1.45	125000 28100	

⁽¹⁾Based on 1×10^6 revolutions L_{10} life, for the ISO life-calculation method.

⁽²⁾Consult your Timken engineer for instructions on use or review the Timken Engineering Manual on timken.com/catalogs.

⁽³⁾Based on 90×10^6 revolutions L_{10} life, for The Timken Company life-calculation method. C_{90} and C_{a90} are radial and thrust values.

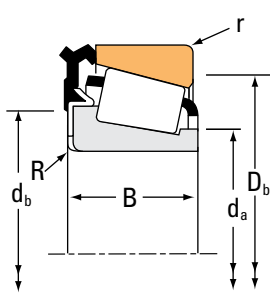


Fig. 1. Backing shoulder against seal backface.

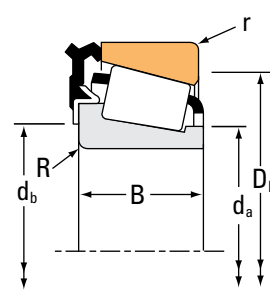
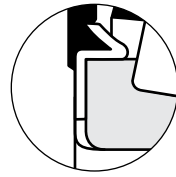
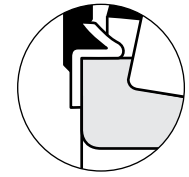


Fig. 2. Backing shoulder against cone (inner-ring) backface (below seal).



Part Number				Bearing Dimensions							Geometry Factors			Bearing Weight
Inner	Outer	Seal	Fig.	Bearing		Shaft			Housing		G ₁	G ₂	C _g	
				Inner Ring Width B	Eff. Ctr. a ⁽⁴⁾	Max. Shaft Fillet Radius R ⁽⁵⁾	Backing Shoulder Dia. d _a	Backing Shoulder Dia. d _b	Max. Housing Fillet Radius r ⁽⁵⁾	Backing Shoulder Dia. D _b				
				mm in.	mm in.	mm in.	mm in.	mm in.	mm in.	mm in.				kg lbs.
LM11949	LM11910	LM11900EA	2	16.637 0.6550	-5.6 -0.22	1.3 0.05	23.5 0.93	25.0 0.98	1.3 0.05	39.5 1.56	6.6	5.5	0.0441	0.12 0.28
LM11949	LM11910	LM11900LA	1	16.637 0.6550	-5.6 -0.22	1.3 0.05	23.5 0.93	25.0 0.98	1.3 0.05	39.5 1.56	6.6	5.5	0.0441	0.12 0.28
M12649	M12610	M12600LA	1	18.288 0.7200	-6.4 -0.25	1.3 0.05	27.5 1.08	29.5 1.16	1.3 0.05	44.0 1.73	9.1	5.6	0.0479	0.17 0.37
07100	07196	07000LA	1	14.260 0.5614	-2.8 -0.11	1.0 0.04	29.5 1.16	30.5 1.20	1.0 0.04	44.5 1.75	7.6	7.1	0.0509	0.11 0.25
L44642	L44610	L44600LC	1	14.732 0.5800	-3.3 -0.13	3.5 0.14	29.5 1.16	36.0 1.42	1.3 0.05	44.5 1.75	8.9	8.9	0.0526	0.13 0.27
L44643	L44610	L44600LA	2	14.732 0.5800	-3.3 -0.13	1.3 0.05	30.0 1.18	32.0 1.26	1.3 0.05	44.5 1.75	8.9	8.9	0.0526	0.13 0.28
L44643X	L44610	L44600LB	2	14.732 0.5800	-3.3 -0.13	1.3 0.05	29.5 1.16	31.8 1.25	1.3 0.05	44.5 1.75	8.9	8.9	0.0526	0.13 0.28
LM67048	LM67010	LM67000LA	1	16.764 0.6600	-3 -0.12	3.5 0.14	36.0 1.42	42.5 1.67	1.3 0.05	52.0 2.05	12.8	9.7	0.0612	0.18 0.39
LM48548	LM48510	LM48500LA	1	18.288 0.7200	-3.6 -0.14	3.5 0.14	41.5 1.63	48.0 1.89	1.3 0.05	58.0 2.28	18.0	10.6	0.0666	0.25 0.54
LM29748	LM29710	LM29700LA	1	18.288 0.7200	-4.1 -0.16	3.5 0.14	42.5 1.67	49.0 1.93	1.3 0.05	58.9 2.32	20.4	15.0	0.0666	0.23 0.50
13685	13621A	13600LA	1	19.050 0.7500	-3 -0.12	3.5 0.14	43.0 1.69	49.5 1.95	2.3 0.09	61.0 2.40	20.7	12.2	0.0713	0.27 0.60
13685	13621	13600LA	1	19.050 0.7500	-3 -0.12	3.5 0.14	43.0 1.69	49.5 1.95	2.3 0.09	61.0 2.40	20.7	12.2	0.0713	0.28 0.62
390A	394A	395LC	1	21.996 0.8660	-0.8 -0.03	1.5 0.06	70.0 2.76	73.0 2.87	1.3 0.05	101.0 3.98	56.0	21.4	0.0984	0.84 1.84
399A	394A	395LA	1	21.996 0.8660	-0.8 -0.03	2.3 0.09	74.0 2.91	78.0 3.07	1.3 0.05	101.0 3.98	56.0	21.4	0.0984	0.75 1.65

⁽⁴⁾Negative value indicates effective center inside cone (inner-ring) backface.

⁽⁵⁾These maximum fillet radii will be cleared by the bearing corners.

TAPERED ROLLER BEARINGS

DOUBLE-ROW • TYPE TDO

TYPE TDO

- TDO consists of a single-piece (double) outer ring and two single inner rings.
- This configuration offers a wide effective bearing spread to support loads created by overturning moments.
- These bearings can be used at fixed positions or allowed to float in the housing bore to compensate for shaft expansion.



DOUBLE-OUTER RING CONFIGURATIONS

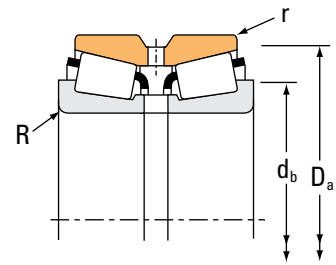
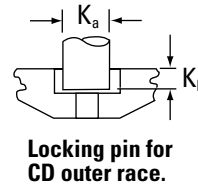
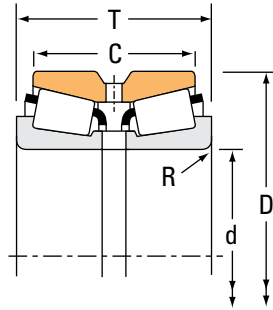
D	D suffix has a groove with oil holes for lubrication through the outer ring.
CD	CD suffix now replaces the DC suffix listed for part numbers in previous publications. Same features as D suffix, but CD also has groove with oil holes. One lubrication hole is counterbored to accept an anti-rotational pin. Default configuration for most series.

- TDO bearings are usually supplied complete with an inner-ring spacer as a pre-set assembly.
- To suit the application duty, the built-in setting value needs to be established by your Timken engineer before an order is placed.
- For spacer configuration information, contact your Timken engineer.
- Double outer ring can be used with any single inner ring from the same series.
- The tables list regularly specified inner-ring part numbers.
- Consult your Timken engineer before making a final bearing selection to help ensure suitability, availability and the most cost-effective solution.

TAPERED ROLLER BEARINGS

DOUBLE-ROW • TYPE TDO

TYPE TDO



Bearing Dimensions				Load Ratings							
Bore d	O.D. D	Width T	Double Outer Ring Width C	Dynamic ⁽¹⁾		Factors ⁽²⁾		Dynamic ⁽³⁾			Factors ⁽²⁾
				C ₁₍₂₎	e	Y ₁	Y ₂	C ₉₀	C _{a90}	C ₉₀₍₂₎	K
mm in.	mm in.	mm in.	mm in.	N lbf				N lbf	N lbf	N lbf	
11.987 0.4719	30.480 1.2000	25.400 1.0000	21.260 0.8370	18800 4230	0.41	1.67	2.48	2800 630	1940 437	4880 1100	1.44
14.989 0.5901	34.988 1.3775	25.174 0.9911	20.638 0.8125	22900 5150	0.45	1.49	2.22	3410 767	2640 594	5940 1330	1.29
16.993 0.6690	47.000 1.8504	31.750 1.2500	25.212 0.9926	46500 10500	0.36	1.89	2.82	6930 1560	4230 952	12100 2710	1.64
19.050 0.7500	47.000 1.8504	31.750 1.2500	25.212 0.9926	46500 10500	0.36	1.89	2.82	6930 1560	4230 952	12100 2710	1.64
19.050 0.7500	57.150 2.2500	49.212 1.9375	36.512 1.4375	95900 21600	0.59	1.14	1.70	14300 3210	14400 3250	24900 5590	0.99
19.987 0.7869	47.000 1.8504	31.750 1.2500	25.212 0.9926	46500 10500	0.36	1.89	2.82	6930 1560	4230 952	12100 2710	1.64
20.000 0.7874	50.005 1.9687	33.340 1.3126	25.400 1.0000	50700 11400	0.40	1.68	2.50	7550 1700	5190 1170	13100 2950	1.45
24.384 0.9600	80.962 3.1875	55.562 2.1875	39.688 1.5625	160000 36000	0.67	1.01	1.50	23900 5360	27300 6130	41500 9340	0.87
24.981 0.9835	50.005 1.9687	33.340 1.3126	25.400 1.0000	50700 11400	0.40	1.68	2.50	7550 1700	5190 1170	13100 2950	1.45
24.981 0.9835	62.000 2.4409	39.688 1.5625	36.258 1.4275	75300 16900	0.38	1.77	2.63	11200 2520	7340 1650	19500 4390	1.53
25.000 0.9843	50.005 1.9687	33.340 1.3126	25.400 1.0000	50700 11400	0.40	1.68	2.50	7550 1700	5190 1170	13100 2950	1.45
25.000 0.9843	62.000 2.4409	39.688 1.5625	36.258 1.4275	75300 16900	0.38	1.77	2.63	11200 2520	7340 1650	19500 4390	1.53
25.400 1.0000	50.005 1.9687	33.340 1.3126	25.400 1.0000	50700 11400	0.40	1.68	2.50	7550 1700	5190 1170	13100 2950	1.45
25.400 1.0000	50.005 1.9687	33.340 1.3126	25.400 1.0000	50700 11400	0.40	1.68	2.50	7550 1700	5190 1170	13100 2950	1.45
25.400 1.0000	63.500 2.5000	46.038 1.8125	36.512 1.4375	104000 23400	0.35	1.93	2.87	15500 3490	9310 2090	27000 6080	1.67
25.400 1.0000	63.500 2.5000	46.038 1.8125	36.512 1.4375	104000 23400	0.35	1.93	2.87	15500 3490	9310 2090	27000 6080	1.67
25.400 1.0000	71.438 2.8125	42.862 1.6875	36.512 1.4375	102000 23000	0.36	1.87	2.79	15200 3420	9390 2110	26500 5960	1.62

⁽¹⁾Based on 1 x 10⁶ revolutions L₁₀ life, for the ISO life-calculation method. C₁₍₂₎ is the double-row radial value.

⁽²⁾Consult your Timken engineer for instructions on use or review the Timken Engineering Manual on timken.com/catalogs.

⁽³⁾Based on 90 x 10⁶ revolutions L₁₀ life, for The Timken Company life-calculation method. C₉₀ and C_{a90} are radial and thrust values for a single row. C₉₀₍₂₎ is the double-row radial value.

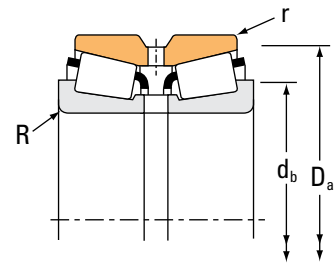
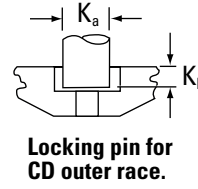
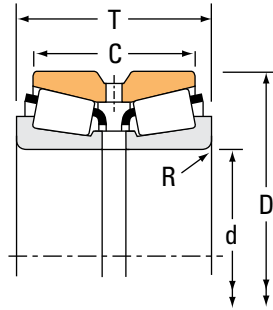
Part Number		Dimensions						Geometry Factors			Bearing Weight
Inner	Outer	Shaft		Housing		Pin		G ₁	G ₂	C _g	
		Max. Shaft Fillet Radius R ⁽⁴⁾	Backing Shoulder Dia. d _b	Max. Housing Fillet Radius r ⁽⁴⁾	Backing Shoulder Dia. D _a	K _a	K _b				
		mm in.	mm in.	mm in.	mm in.	mm in.	mm in.				kg lbs.
A2047	A2120D	0.8 0.03	16.5 0.65	0.4 0.02	28.0 1.10	– –	– –	1.7	3.2	0.0308	0.09 0.19
A4059	A4138D	0.8 0.03	19.5 0.77	0.6 0.03	31.5 1.24	– –	– –	2.3	4.1	0.0355	0.11 0.26
05066	05185D	1.5 0.06	24.5 0.96	0.8 0.03	42.5 1.67	– –	– –	5.8	5.5	0.0448	0.29 0.62
05075	05185D	1.3 0.05	25.0 0.98	0.8 0.03	42.5 1.67	– –	– –	5.8	5.5	0.0448	0.27 0.59
21075	21226D	1.5 0.06	31.5 1.24	0.8 0.03	51.0 2.01	– –	– –	7.0	4.1	0.0558	0.65 1.44
05079	05185D	1.5 0.06	26.5 1.04	0.8 0.03	42.5 1.67	– –	– –	5.8	5.5	0.0448	0.27 0.57
07079	07196D	1.5 0.06	27.5 1.08	0.6 0.03	46.5 1.83	– –	– –	7.6	7.1	0.0509	0.31 0.70
43096	43319D	0.8 0.03	40.5 1.59	1.5 0.06	74.0 2.91	– –	– –	16.8	7.6	0.0774	1.43 3.14
07098	07196D	1.5 0.06	31.0 1.22	0.6 0.03	46.5 1.83	– –	– –	7.6	7.1	0.0509	0.27 0.61
17098	17245D	1.5 0.06	33.0 1.30	0.8 0.03	57.0 2.24	– –	– –	11.8	7.5	0.0579	0.60 1.33
07097	07196D	1.5 0.06	31.0 1.22	0.6 0.03	46.5 1.83	– –	– –	7.6	7.1	0.0509	0.27 0.61
17098X	17245D	1.5 0.06	33.0 1.30	0.8 0.03	57.0 2.24	– –	– –	11.8	7.5	0.0579	0.60 1.33
07100-S	07196D	1.5 0.06	31.5 1.24	0.6 0.03	46.5 1.83	– –	– –	7.6	7.1	0.0509	0.27 0.60
07100-SA	07196D	3.3 0.13	35.0 1.38	0.6 0.03	46.5 1.83	– –	– –	7.6	7.1	0.0509	0.27 0.59
15101	15251D	0.8 0.03	32.5 1.28	0.8 0.03	59.0 2.32	– –	– –	14.6	10.0	0.0606	0.73 1.59
15100-S	15251D	1.3 0.05	33.5 1.32	0.8 0.03	59.0 2.32	– –	– –	14.6	10.0	0.0606	0.73 1.59
26100	26282D	1.5 0.06	34.5 1.36	0.4 0.02	65.0 2.56	– –	– –	16.1	10.1	0.0630	0.89 1.96

⁽⁴⁾These maximum fillet radii will be cleared by bearing corners.
NOTE: For spacer configuration information, contact your Timken engineer.

TAPERED ROLLER BEARINGS

DOUBLE-ROW • TYPE TDO

TYPE TDO



Bearing Dimensions				Load Ratings							
Bore d	O.D. D	Width T	Double Outer Ring Width C	Dynamic ⁽¹⁾				Dynamic ⁽³⁾			
				C ₁₍₂₎	e	Y ₁	Y ₂	C ₉₀	C _{a90}	C ₉₀₍₂₎	K
mm in.	mm in.	mm in.	mm in.	N lbf				N lbf	N lbf	N lbf	
28.575 1.1250	63.500 2.5000	46.038 1.8125	36.512 1.4375	104000 23400	0.35	1.93	2.87	15500 3490	9310 2090	27000 6080	1.67
28.575 1.1250	76.200 3.0000	47.625 1.8750	38.100 1.5000	114000 25700	0.45	1.49	2.21	17000 3830	13200 2980	29700 6670	1.29
28.575 1.1250	80.962 3.1875	55.562 2.1875	39.688 1.5625	160000 36000	0.67	1.01	1.50	23900 5360	27300 6130	41500 9340	0.87
29.987 1.1806	62.000 2.4409	39.688 1.5625	36.258 1.4275	75300 16900	0.38	1.77	2.63	11200 2520	7340 1650	19500 4390	1.53
29.987 1.1806	63.500 2.5000	46.038 1.8125	36.512 1.4375	104000 23400	0.35	1.93	2.87	15500 3490	9310 2090	27000 6080	1.67
29.987 1.1806	71.438 2.8125	42.862 1.6875	36.512 1.4375	121000 27300	0.36	1.87	2.79	18100 4060	11100 2500	31400 7070	1.62
29.987 1.1806	71.973 2.8336	42.760 1.6835	36.512 1.4375	121000 27300	0.36	1.87	2.79	18100 4060	11100 2500	31400 7070	1.62
30.000 1.1811	69.012 2.7170	46.040 1.8126	38.100 1.5000	95100 21400	0.38	1.77	2.63	14200 3180	9260 2080	24600 5540	1.53
30.000 1.1811	69.012 2.7170	46.040 1.8126	38.100 1.5000	95100 21400	0.38	1.77	2.63	14200 3180	9260 2080	24600 5540	1.53
30.162 1.1875	58.738 2.3125	32.542 1.2812	24.608 0.9688	55200 12400	0.47	1.42	2.12	8220 1850	6670 1500	14300 3220	1.23
30.162 1.1875	62.000 2.4409	39.688 1.5625	36.258 1.4275	75300 16900	0.38	1.77	2.63	11200 2520	7340 1650	19500 4390	1.53
30.162 1.1875	66.421 2.6150	44.450 1.7500	38.100 1.5000	97300 21900	0.34	1.99	2.96	14500 3260	8420 1890	25200 5670	1.72
30.162 1.1875	80.962 3.1875	55.562 2.1875	39.688 1.5625	160000 36000	0.67	1.01	1.50	23900 5360	27300 6130	41500 9340	0.87
30.213 1.1895	63.500 2.5000	40.638 1.8125	36.512 1.4375	104000 23400	0.35	1.93	2.87	15500 3490	9310 2090	27000 6080	1.67
31.750 1.2500	58.738 2.3125	32.542 1.2812	24.608 0.9688	55200 12400	0.47	1.42	2.12	8220 1850	6670 1500	14300 3220	1.23
31.750 1.2500	63.500 2.5000	44.260 1.7425	36.512 1.4375	104000 23400	0.35	1.93	2.87	15500 3490	9310 2090	27000 6080	1.67
31.750 1.2500	63.500 2.5000	46.038 1.8125	36.512 1.4375	104000 23400	0.35	1.93	2.87	15500 3490	9310 2090	27000 6080	1.67

⁽¹⁾Based on 1 x 10⁶ revolutions L₁₀ life, for the ISO life-calculation method. C₁₍₂₎ is the double-row radial value.

⁽²⁾Consult your Timken engineer for instructions on use or review the Timken Engineering Manual on timken.com/catalogs.

⁽³⁾Based on 90 x 10⁶ revolutions L₁₀ life, for The Timken Company life-calculation method. C₉₀ and C_{a90} are radial and thrust values for a single row. C₉₀₍₂₎ is the double-row radial value.

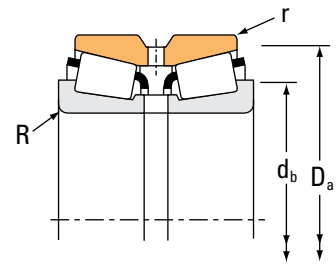
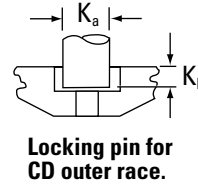
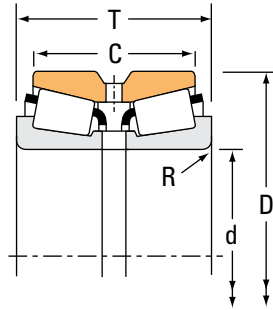
Part Number		Dimensions						Geometry Factors			Bearing Weight
Inner	Outer	Shaft		Housing		Pin		G ₁	G ₂	C _G	
		Max. Shaft Fillet Radius R ⁽⁴⁾	Backing Shoulder Dia. d _b	Max. Housing Fillet Radius r ⁽⁴⁾	Backing Shoulder Dia. D _a	K _a	K _b				
		mm in.	mm in.	mm in.	mm in.	mm in.	mm in.				kg lbs.
15112	15251D	3.5 0.14	40.0 1.57	0.8 0.03	59.0 2.32	– –	– –	14.6	10.0	0.0606	0.66 1.45
02872	02823D	0.8 0.03	37.5 1.48	0.8 0.03	70.0 2.76	– –	– –	20.6	10.1	0.0740	1.13 2.49
43112	43319D	0.8 0.03	42.5 1.67	1.5 0.06	74.0 2.91	– –	– –	16.8	7.6	0.0774	1.37 3.01
17118	17245D	1.5 0.06	38.5 1.52	0.8 0.03	57.0 2.24	– –	– –	11.8	7.5	0.0579	0.53 1.18
15117	15251D	1.3 0.05	36.5 1.44	0.8 0.03	59.0 2.32	– –	– –	14.6	10.0	0.0606	0.66 1.43
26118	26282D	1.5 0.06	38.0 1.50	0.4 0.02	65.0 2.56	– –	– –	16.1	10.1	0.0630	0.83 1.83
26118	26284D	1.5 0.06	38.0 1.50	0.8 0.03	65.0 2.56	– –	– –	16.1	10.1	0.0630	0.84 1.85
14118	14276D	0.8 0.03	37.0 1.46	0.8 0.03	63.0 2.48	– –	– –	18.0	13.3	0.0668	0.78 1.75
14117A	14276D	3.5 0.14	44.0 1.73	0.8 0.03	63.0 2.48	– –	– –	18.0	13.3	0.0668	0.78 1.75
08118	08231D	3.5 0.14	41.5 1.63	0.4 0.02	55.0 2.17	– –	– –	10.7	10.6	0.0601	0.38 0.81
17119	17245D	1.5 0.06	37.0 1.46	0.8 0.03	57.0 2.24	– –	– –	11.8	7.5	0.0579	0.53 1.19
24118	24262D	1.5 0.06	37.5 1.48	0.8 0.03	61.0 2.40	– –	– –	14.0	8.3	0.0589	0.69 1.53
43118	43319D	1.5 0.06	45.0 1.77	1.5 0.06	74.0 2.91	– –	– –	16.8	7.6	0.0774	1.33 2.93
15119	15251D	1.5 0.06	37.5 1.48	0.8 0.03	59.0 2.32	– –	– –	14.6	10.0	0.0606	0.64 1.43
08125	08231D	1.0 0.04	37.5 1.48	0.4 0.02	55.0 2.17	– –	– –	10.7	10.6	0.0601	0.36 0.79
15123	15251D	3.5 0.14	44.0 1.73	0.8 0.03	59.0 2.32	– –	– –	14.6	10.0	0.0606	0.58 1.30
15125	15251D	3.5 0.14	42.5 1.67	0.8 0.03	59.0 2.32	– –	– –	14.6	10.0	0.0606	0.62 1.35

⁽⁴⁾These maximum fillet radii will be cleared by bearing corners.
NOTE: For spacer configuration information, contact your Timken engineer.

TAPERED ROLLER BEARINGS

DOUBLE-ROW • TYPE TDO

TYPE TDO



Bearing Dimensions				Load Ratings							
Bore d	O.D. D	Width T	Double Outer Ring Width C	Dynamic ⁽¹⁾				Dynamic ⁽³⁾			
				C ₁₍₂₎	e	Y ₁	Y ₂	C ₉₀	C _{a90}	C ₉₀₍₂₎	K
mm in.	mm in.	mm in.	mm in.	N lbf				N lbf	N lbf	N lbf	
31.750 1.2500	63.500 2.5000	46.038 1.8125	36.512 1.4375	104000 23400	0.35	1.93	2.87	15500 3490	9310 2090	27000 6080	1.67
31.750 1.2500	69.012 2.7170	46.040 1.8126	38.100 1.5000	95100 21400	0.38	1.77	2.63	14200 3180	9260 2080	24600 5540	1.53
31.750 1.2500	69.850 2.7500	66.675 2.6250	57.150 2.2500	146000 32800	0.27	2.47	3.67	21700 4880	10200 2280	37800 8500	2.14
31.750 1.2500	76.200 3.0000	47.625 1.8750	38.100 1.5000	114000 25700	0.45	1.49	2.21	17000 3830	13200 2980	29700 6670	1.29
31.750 1.2500	80.962 3.1875	55.562 2.1875	39.688 1.5625	160000 36000	0.67	1.01	1.50	23900 5360	27300 6130	41500 9340	0.87
31.750 1.2500	82.550 3.2500	66.678 2.6251	55.562 2.1875	182000 41000	0.37	1.85	2.75	27100 6100	17000 3820	47200 10600	1.60
33.338 1.3125	69.012 2.7170	46.040 1.8126	38.100 1.5000	95100 21400	0.38	1.77	2.63	14200 3180	9260 2080	24600 5540	1.53
33.337 1.3125	69.850 2.7500	66.675 2.6250	57.150 2.2500	146000 32800	0.27	2.47	3.67	21700 4880	10200 2280	37800 8500	2.14
33.337 1.3125	71.438 2.8125	42.862 1.6875	36.512 1.4375	121000 27300	0.36	1.87	2.79	18100 4060	11100 2500	31400 7070	1.62
33.337 1.3125	71.973 2.8336	42.760 1.6835	36.512 1.4375	121000 27300	0.36	1.87	2.79	18100 4060	11100 2500	31400 7070	1.62
33.337 1.3125	80.962 3.1875	55.562 2.1875	39.688 1.5625	160000 36000	0.67	1.01	1.50	23900 5360	27300 6130	41500 9340	0.87
33.337 1.3125	80.962 3.1875	55.563 2.1875	39.688 1.5625	160000 36000	0.67	1.01	1.50	23900 5360	27300 6130	41500 9340	0.87
34.925 1.3750	69.012 2.7170	46.040 1.8126	38.100 1.5000	95100 21400	0.38	1.77	2.63	14200 3180	9260 2080	24600 5540	1.53
34.925 1.3750	69.012 2.7170	46.040 1.8126	38.100 1.5000	95100 21400	0.38	1.77	2.63	14200 3180	9260 2080	24600 5540	1.53
34.925 1.3750	76.200 3.0000	47.625 1.8750	38.100 1.5000	114000 25700	0.45	1.49	2.21	17000 3830	13200 2980	29700 6670	1.29
34.925 1.3750	76.200 3.0000	47.625 1.8750	38.100 1.5000	114000 25700	0.45	1.49	2.21	17000 3830	13200 2980	29700 6670	1.29
34.925 1.3750	80.035 3.1510	46.040 1.8126	34.925 1.3750	131000 29500	0.40	1.68	2.50	19500 4390	13400 3020	34000 7640	1.45

⁽¹⁾Based on 1 x 10⁶ revolutions L₁₀ life, for the ISO life-calculation method. C₁₍₂₎ is the double-row radial value.

⁽²⁾Consult your Timken engineer for instructions on use or review the Timken Engineering Manual on timken.com/catalogs.

⁽³⁾Based on 90 x 10⁶ revolutions L₁₀ life, for The Timken Company life-calculation method. C₉₀ and C_{a90} are radial and thrust values for a single row. C₉₀₍₂₎ is the double-row radial value.

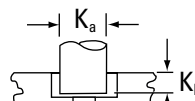
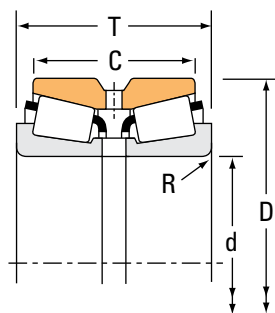
Part Number		Dimensions						Geometry Factors			Bearing Weight
Inner	Outer	Shaft		Housing		Pin		G ₁	G ₂	C _G	
		Max. Shaft Fillet Radius R ⁽⁴⁾	Backing Shoulder Dia. d _b	Max. Housing Fillet Radius r ⁽⁴⁾	Backing Shoulder Dia. D _a	K _a	K _b				
		mm in.	mm in.	mm in.	mm in.	mm in.	mm in.				kg lbs.
15126	15251D	0.8 0.03	38.5 1.52	0.8 0.03	59.0 2.32	– –	– –	14.6	10.0	0.0606	0.62 1.37
14125A	14276D	3.5 0.14	45.0 1.77	0.8 0.03	63.0 2.48	– –	– –	18.0	13.3	0.0668	0.75 1.68
2580	2524YD	0.8 0.03	38.5 1.52	0.8 0.03	64.0 2.52	– –	– –	23.6	9.6	0.0656	1.18 2.61
02875	02823D	3.5 0.14	45.5 1.79	0.8 0.03	70.0 2.76	– –	– –	20.6	10.1	0.0740	1.07 2.35
43125	43319D	1.5 0.06	44.0 1.73	1.5 0.06	74.0 2.91	– –	– –	16.8	7.6	0.0774	1.31 2.88
3476	3423D	1.3 0.05	43.0 1.69	0.8 0.03	75.0 2.95	– –	– –	29.9	11.2	0.0781	1.84 4.05
14131	14276D	0.8 0.03	41.0 1.61	0.8 0.03	63.0 2.48	– –	– –	18.0	13.3	0.0668	0.73 1.63
2585	2523D	3.5 0.14	45.0 1.77	0.8 0.03	64.0 2.52	– –	– –	23.6	9.6	0.0656	1.15 2.51
26131	26282D	3.5 0.14	44.5 1.75	0.4 0.02	65.0 2.56	– –	– –	16.1	10.1	0.0630	0.76 1.67
26131	26284D	3.5 0.14	44.5 1.75	0.8 0.03	65.0 2.56	– –	– –	16.1	10.1	0.0630	0.78 1.71
43131	43319D	3.5 0.14	51.0 2.01	1.5 0.06	74.0 2.91	– –	– –	16.8	7.6	0.0774	1.27 2.78
43132	43319D	2.0 0.08	48.0 1.89	1.5 0.06	74.0 2.91	– –	– –	16.8	7.6	0.0774	1.27 2.80
14137A	14276D	1.5 0.06	43.5 1.71	0.8 0.03	63.0 2.48	– –	– –	18.0	13.3	0.0668	0.71 1.57
14138A	14276D	3.5 0.14	48.0 1.89	0.8 0.03	63.0 2.48	– –	– –	18.0	13.3	0.0668	0.71 1.56
02877	02823D	3.5 0.14	48.5 1.91	0.8 0.03	70.0 2.76	– –	– –	20.6	10.1	0.0740	1.01 2.21
02878	02823D	0.8 0.03	42.5 1.67	0.8 0.03	70.0 2.76	– –	– –	20.6	10.1	0.0740	1.01 2.24
28137	28318D	1.5 0.06	43.5 1.71	0.8 0.03	73.0 2.87	– –	– –	20.7	12.5	0.0709	1.05 2.31

⁽⁴⁾These maximum fillet radii will be cleared by bearing corners.
NOTE: For spacer configuration information, contact your Timken engineer.

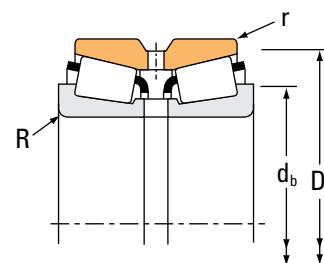
TAPERED ROLLER BEARINGS

DOUBLE-ROW • TYPE TDO

TYPE TDO



Locking pin for CD outer race.



Bearing Dimensions				Load Ratings							
Bore d	O.D. D	Width T	Double Outer Ring Width C	Dynamic ⁽¹⁾				Dynamic ⁽³⁾			
				C ₁₍₂₎	e	Y ₁	Y ₂	C ₉₀	C _{a90}	C ₉₀₍₂₎	K
mm in.	mm in.	mm in.	mm in.	N lbf				N lbf	N lbf	N lbf	
34.925 1.3750	80.035 3.1510	57.150 2.2500	44.958 1.7700	136000 30500	0.56	1.20	1.79	20200 4550	19400 4370	35200 7920	1.04
34.976 1.3770	69.012 2.7170	46.040 1.8126	38.100 1.5000	95100 21400	0.38	1.77	2.63	14200 3180	9260 2080	24600 5540	1.53
36.512 1.4375	82.550 3.2500	66.678 2.6251	55.562 2.1875	182000 41000	0.37	1.85	2.75	27100 6100	17000 3820	47200 10600	1.60
36.512 1.4375	82.931 3.2650	57.150 2.2500	47.625 1.8750	158000 35400	0.33	2.02	3.00	23500 5270	13500 3020	40900 9180	1.74
36.512 1.4375	92.075 3.6250	55.562 2.1875	39.688 1.5625	174000 39100	0.78	0.86	1.29	25900 5810	34600 7770	45000 10100	0.75
38.100 1.5000	63.500 2.5000	38.100 1.5000	31.750 1.2500	47300 10600	0.35	1.95	2.90	7040 1580	4170 938	12300 2760	1.69
38.100 1.5000	69.012 2.7170	46.035 1.8124	38.100 1.5000	117000 26300	0.40	1.68	2.50	17400 3920	12000 2700	30300 6820	1.45
38.100 1.5000	69.012 2.7170	46.035 1.8124	38.100 1.5000	117000 26300	0.40	1.68	2.50	17400 3920	12000 2700	30300 6820	1.45
38.100 1.5000	80.035 3.1510	46.040 1.8126	34.925 1.3750	131000 29500	0.40	1.68	2.50	19500 4390	13400 3020	34000 7640	1.45
38.100 1.5000	80.035 3.1510	57.150 2.2500	44.958 1.7700	136000 30500	0.56	1.20	1.79	20200 4550	19400 4370	35200 7920	1.04
38.100 1.5000	80.035 3.1510	57.150 2.2500	44.958 1.7700	136000 30500	0.56	1.20	1.79	20200 4550	19400 4370	35200 7920	1.04
38.100 1.5000	82.550 3.2500	66.678 2.6251	55.562 2.1875	182000 41000	0.37	1.85	2.75	27100 6100	17000 3820	47200 10600	1.60
38.100 1.5000	82.931 3.2650	57.150 2.2500	47.625 1.8750	158000 35400	0.33	2.02	3.00	23500 5270	13500 3020	40900 9180	1.74
38.100 1.5000	92.075 3.6250	55.562 2.1875	39.688 1.5625	174000 39100	0.78	0.86	1.29	25900 5810	34600 7770	45000 10100	0.75
38.100 1.5000	95.250 3.7500	63.500 2.5000	52.385 2.0624	226000 50800	0.33	2.05	3.05	33600 7560	19000 4270	58600 13200	1.77
38.100 1.5000	95.250 3.7500	65.090 2.5626	44.450 1.7500	207000 46500	0.74	0.91	1.36	30800 6920	39000 8760	53600 12000	0.79
38.100 1.5000	111.125 4.3750	79.375 3.1250	63.500 2.5000	300000 67400	0.30	2.28	3.39	44600 10000	22700 5090	77700 17500	1.97

⁽¹⁾Based on 1 x 10⁶ revolutions L₁₀ life, for the ISO life-calculation method. C₁₍₂₎ is the double-row radial value.

⁽²⁾Consult your Timken engineer for instructions on use or review the Timken Engineering Manual on timken.com/catalogs.

⁽³⁾Based on 90 x 10⁶ revolutions L₁₀ life, for The Timken Company life-calculation method. C₉₀ and C_{a90} are radial and thrust values for a single row. C₉₀₍₂₎ is the double-row radial value.

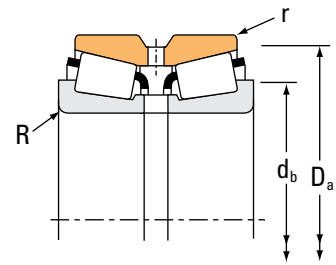
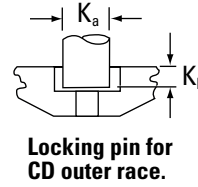
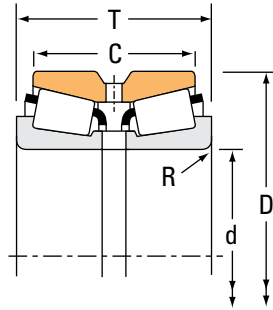
Part Number		Dimensions						Geometry Factors			Bearing Weight
Inner	Outer	Shaft		Housing		Pin		G ₁	G ₂	C _G	
		Max. Shaft Fillet Radius R ⁽⁴⁾	Backing Shoulder Dia. d _b	Max. Housing Fillet Radius r ⁽⁴⁾	Backing Shoulder Dia. D _a	K _a	K _b				
		mm in.	mm in.	mm in.	mm in.	mm in.	mm in.				kg lbs.
27875	27820D	0.8 0.03	45.5 1.79	0.8 0.03	75.0 2.95	– –	– –	24.6	12.6	0.0839	1.32 2.93
14139	14276D	1.3 0.05	43.5 1.71	0.8 0.03	63.0 2.48	– –	– –	18.0	13.3	0.0668	0.71 1.57
3479	3423D	0.8 0.03	45.5 1.79	0.8 0.03	75.0 2.95	– –	– –	29.9	11.2	0.0781	1.71 3.77
25570	25520D	3.5 0.14	51.0 2.01	0.8 0.03	77.0 3.03	– –	– –	35.2	14.3	0.0801	1.53 3.36
44143	44363D	2.3 0.09	54.0 2.13	1.5 0.06	85.0 3.35	– –	– –	22.9	8.7	0.0899	1.72 3.78
13889	13835D	1.5 0.06	45.0 1.77	0.4 0.02	60.0 2.36	– –	– –	14.8	23.3	0.0601	0.32 0.70
13685	13621D	3.5 0.14	49.5 1.95	0.8 0.03	65.0 2.56	– –	– –	20.7	12.2	0.0713	0.66 1.45
13687	13621D	2.0 0.08	46.5 1.83	0.8 0.03	65.0 2.56	– –	– –	20.7	12.2	0.0713	0.66 1.46
28150	28318D	1.5 0.06	45.5 1.79	0.8 0.03	73.0 2.87	– –	– –	20.7	12.5	0.0709	0.98 2.16
27880	27820D	0.8 0.03	48.0 1.89	0.8 0.03	75.0 2.95	– –	– –	24.6	12.6	0.0839	1.22 2.69
27881	27820D	3.5 0.14	53.0 2.09	0.8 0.03	75.0 2.95	– –	– –	24.6	12.6	0.0839	1.20 2.66
3490	3423D	3.5 0.14	52.0 2.05	0.8 0.03	75.0 2.95	– –	– –	29.9	11.2	0.0781	1.65 3.64
25572	25520D	0.8 0.03	46.0 1.81	0.8 0.03	77.0 3.03	– –	– –	35.2	14.3	0.0801	1.49 3.26
44150	44363D	2.3 0.09	55.0 2.17	1.5 0.06	85.0 3.35	– –	– –	22.9	8.7	0.0899	1.67 3.69
33880	33821D	3.5 0.14	54.0 2.13	0.8 0.03	90.0 3.54	– –	– –	52.5	18.5	0.0910	2.26 4.97
53150	53376D	1.5 0.06	55.0 2.17	0.8 0.03	89.0 3.50	– –	– –	26.7	9.6	0.0930	2.08 4.62
542	533D	3.5 0.14	55.0 2.17	1.5 0.06	100.0 3.94	– –	– –	64.3	16.1	0.0938	4.04 8.88

⁽⁴⁾These maximum fillet radii will be cleared by bearing corners.
NOTE: For spacer configuration information, contact your Timken engineer.

TAPERED ROLLER BEARINGS

DOUBLE-ROW • TYPE TDO

TYPE TDO



Bearing Dimensions				Load Ratings							
Bore d	O.D. D	Width T	Double Outer Ring Width C	Dynamic ⁽¹⁾				Dynamic ⁽³⁾			
				C ₁₍₂₎	e	Y ₁	Y ₂	C ₉₀	C _{a90}	C ₉₀₍₂₎	K
mm in.	mm in.	mm in.	mm in.	N lbf				N lbf	N lbf	N lbf	
38.481 1.5150	63.500 2.5000	38.100 1.5000	31.750 1.2500	47300 10600	0.35	1.95	2.90	7040 1580	4170 938	12300 2760	1.69
39.687 1.5625	92.075 3.6250	55.562 2.1875	39.688 1.5625	174000 39100	0.78	0.86	1.29	25900 5810	34600 7770	45000 10100	0.75
39.980 1.5740	80.035 3.1510	46.040 1.8126	34.925 1.3750	111000 24800	0.40	1.68	2.50	16500 3700	11300 2550	28700 6440	1.45
40.000 1.5748	80.035 3.1510	46.040 1.8126	34.925 1.3750	131000 29500	0.40	1.68	2.50	19500 4390	13400 3020	34000 7640	1.45
40.000 1.5748	90.119 3.5480	50.800 2.0000	44.450 1.7500	169000 38000	0.31	2.20	3.28	25100 5650	13200 2960	43800 9840	1.91
40.000 1.5748	90.119 3.5480	50.800 2.0000	44.450 1.7500	169000 38000	0.31	2.20	3.28	25100 5650	13200 2960	43800 9840	1.91
41.275 1.6250	90.000 3.5433	50.010 1.9689	42.070 1.6563	177000 39900	0.32	2.11	3.14	26400 5930	14400 3250	46000 10300	1.83
41.275 1.6250	92.075 3.6250	55.562 2.1875	39.688 1.5625	174000 39100	0.78	0.86	1.29	25900 5810	34600 7770	45000 10100	0.75
41.275 1.6250	95.250 3.7500	61.915 2.4376	50.800 2.0000	221000 49700	0.28	2.37	3.53	32900 7400	16000 3600	57300 12900	2.05
41.275 1.6250	107.950 4.2500	65.090 2.5626	53.975 2.1250	236000 53100	0.34	2.01	3.00	35200 7900	20200 4540	61200 13800	1.74
42.862 1.6875	82.550 3.2500	44.450 1.7500	34.925 1.3750	135000 30300	0.43	1.57	2.34	20100 4510	14800 3320	35000 7860	1.36
42.862 1.6875	82.931 3.2650	57.150 2.2500	47.625 1.8750	158000 35400	0.33	2.02	3.00	23500 5270	13500 3020	40900 9180	1.74
44.450 1.7500	79.375 3.1250	41.272 1.6249	33.338 1.3125	90600 20400	0.37	1.80	2.69	13500 3030	8630 1940	23500 5280	1.56
44.450 1.7500	82.931 3.2650	57.150 2.2500	47.625 1.8750	158000 35400	0.33	2.02	3.00	23500 5270	13500 3020	40900 9180	1.74
44.450 1.7500	82.931 3.2650	57.150 2.2500	47.625 1.8750	158000 35400	0.33	2.02	3.00	23500 5270	13500 3020	40900 9180	1.74
44.450 1.7500	90.119 3.5480	50.800 2.0000	44.450 1.7500	169000 38000	0.31	2.20	3.28	25100 5650	13200 2960	43800 9840	1.91
44.450 1.7500	90.119 3.5480	50.800 2.0000	44.450 1.7500	169000 38000	0.31	2.20	3.28	25100 5650	13200 2960	43800 9840	1.91

⁽¹⁾Based on 1×10^6 revolutions L_{10} life, for the ISO life-calculation method. $C_{1(2)}$ is the double-row radial value.

⁽²⁾Consult your Timken engineer for instructions on use or review the Timken Engineering Manual on timken.com/catalogs.

⁽³⁾Based on 90×10^6 revolutions L_{10} life, for The Timken Company life-calculation method. C_{90} and C_{a90} are radial and thrust values for a single row. $C_{90(2)}$ is the double-row radial value.

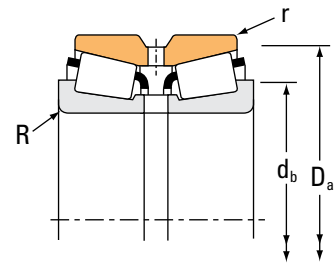
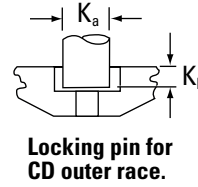
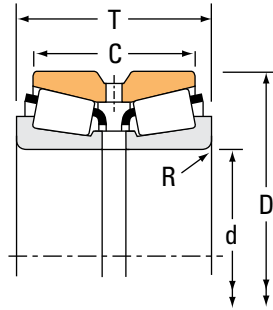
Part Number		Dimensions						Geometry Factors			Bearing Weight
Inner	Outer	Shaft		Housing		Pin		G ₁	G ₂	C _g	
		Max. Shaft Fillet Radius R ⁽⁴⁾	Backing Shoulder Dia. d _b	Max. Housing Fillet Radius r ⁽⁴⁾	Backing Shoulder Dia. D _a	K _a	K _b				
		mm in.	mm in.	mm in.	mm in.	mm in.	mm in.				kg lbs.
13890	13835D	0.4 0.02	43.0 1.69	0.4 0.02	60.0 2.36	–	–	14.8	23.3	0.0601	0.41 0.91
44156	44363D	2.3 0.09	56.0 2.20	1.5 0.06	85.0 3.35	–	–	22.9	8.7	0.0899	1.63 3.62
28159	28318D	3.5 0.14	52.0 2.05	0.8 0.03	73.0 2.87	–	–	20.7	12.5	0.0709	0.93 2.07
28158	28318D	1.5 0.06	47.5 1.87	0.8 0.03	73.0 2.87	–	–	20.7	12.5	0.0709	0.94 2.07
357	353D	2.3 0.09	51.0 2.01	0.8 0.03	82.0 3.23	–	–	30.0	12.2	0.0732	1.53 3.37
350A	353D	0.8 0.03	47.5 1.87	0.8 0.03	82.0 3.23	–	–	30.0	12.2	0.0732	1.53 3.38
365A	363D	3.5 0.14	55.0 2.17	0.8 0.03	84.0 3.31	–	–	33.8	14.0	0.0773	1.40 3.11
44162	44363D	2.3 0.09	57.0 2.24	1.5 0.06	85.0 3.35	–	–	22.9	8.7	0.0899	1.59 3.53
447	432D	3.5 0.14	55.0 2.17	0.8 0.03	87.0 3.43	–	–	42.5	11.3	0.0805	2.10 4.65
464	452D	2.3 0.09	56.0 2.20	0.8 0.03	100.0 3.94	–	–	58.6	17.1	0.0946	3.06 6.77
22168	22325D	2.3 0.09	52.0 2.05	0.8 0.03	76.0 2.99	–	–	23.7	14.4	0.0758	1.01 2.24
25578	25520D	2.3 0.09	53.0 2.09	0.8 0.03	77.0 3.03	–	–	35.2	14.3	0.0801	1.48 3.28
18685	18620D	2.8 0.11	54.0 2.13	0.8 0.03	74.0 2.91	–	–	23.9	18.7	0.0725	0.78 1.70
25580	25520D	3.5 0.14	57.0 2.24	0.8 0.03	77.0 3.03	–	–	35.2	14.3	0.0801	1.31 2.87
25581	25520D	0.5 0.02	51.0 2.01	0.8 0.03	77.0 3.03	–	–	35.2	14.3	0.0801	1.31 2.92
355	353D	2.3 0.09	54.0 2.13	0.8 0.03	82.0 3.23	–	–	30.0	12.2	0.0732	1.40 3.08
355A	353D	0.8 0.03	51.0 2.01	0.8 0.03	82.0 3.23	–	–	30.0	12.2	0.0732	1.41 3.10

⁽⁴⁾These maximum fillet radii will be cleared by bearing corners.
NOTE: For spacer configuration information, contact your Timken engineer.

TAPERED ROLLER BEARINGS

DOUBLE-ROW • TYPE TDO

TYPE TDO



Bearing Dimensions				Load Ratings							
Bore d	O.D. D	Width T	Double Outer Ring Width C	Dynamic ⁽¹⁾		Factors ⁽²⁾		Dynamic ⁽³⁾			Factors ⁽²⁾
				C ₁₍₂₎	e	Y ₁	Y ₂	C ₉₀	C _{a90}	C ₉₀₍₂₎	K
mm in.	mm in.	mm in.	mm in.	N lbf				N lbf	N lbf	N lbf	
44.450 1.7500	93.264 3.6718	65.088 2.5625	52.388 2.0625	213000 47800	0.34	1.99	2.97	31700 7120	18300 4120	55100 12400	1.73
44.450 1.7500	95.250 3.7500	61.915 2.4376	50.800 2.0000	221000 49700	0.28	2.37	3.53	32900 7400	16000 3600	57300 12900	2.05
44.450 1.7500	95.250 3.7500	61.915 2.4376	50.800 2.0000	221000 49700	0.28	2.37	3.53	32900 7400	16000 3600	57300 12900	2.05
44.450 1.7500	95.250 3.7500	63.500 2.5000	52.385 2.0624	226000 50800	0.33	2.05	3.05	33600 7560	19000 4270	58600 13200	1.77
44.450 1.7500	95.250 3.7500	65.090 2.5626	44.450 1.7500	207000 46500	0.74	0.91	1.36	30800 6920	39000 8760	53600 12000	0.79
44.450 1.7500	95.250 3.7500	65.090 2.5626	44.450 1.7500	207000 46500	0.74	0.91	1.36	30800 6920	39000 8760	53600 12000	0.79
44.450 1.7500	98.425 3.8750	65.090 2.5626	44.450 1.7500	207000 46500	0.74	0.91	1.36	30800 6920	39000 8760	53600 12000	0.79
44.450 1.7500	107.950 4.2500	65.090 2.5626	53.975 2.1250	236000 53100	0.34	2.01	3.00	35200 7900	20200 4540	61200 13800	1.74
44.450 1.7500	112.712 4.4375	65.088 2.5625	46.038 1.8125	220000 49400	0.88	0.76	1.14	32700 7350	49500 11100	56900 12800	0.66
44.450 1.7500	112.712 4.4375	65.088 2.5625	46.038 1.8125	220000 49400	0.88	0.76	1.14	32700 7350	49500 11100	56900 12800	0.66
44.983 1.7710	82.931 3.2650	57.150 2.2500	47.625 1.8750	158000 35400	0.33	2.02	3.00	23500 5270	13500 3020	40900 9180	1.74
44.983 1.7710	93.264 3.6718	65.088 2.5625	52.388 2.0625	213000 47800	0.34	1.99	2.97	31700 7120	18300 4120	55100 12400	1.73
45.000 1.7717	85.000 3.3465	50.750 1.9980	40.000 1.5748	181000 40600	0.40	1.67	2.48	26900 6050	18700 4190	46800 10500	1.44
45.000 1.7717	90.000 3.5433	50.010 1.9689	42.070 1.6563	177000 39900	0.32	2.11	3.14	26400 5930	14400 3250	46000 10300	1.83
45.000 1.7717	90.119 3.5480	50.800 2.0000	44.450 1.7500	169000 38000	0.31	2.20	3.28	25100 5650	13200 2960	43800 9840	1.91
45.000 1.7717	90.119 3.5480	50.800 2.0000	44.450 1.7500	142000 32000	0.31	2.20	3.28	21200 4770	11100 2500	36900 8310	1.91
45.618 1.7960	82.931 3.2650	57.150 2.2500	47.625 1.8750	158000 35400	0.33	2.02	3.00	23500 5270	13500 3020	40900 9180	1.74

⁽¹⁾Based on 1×10^6 revolutions L_{10} life, for the ISO life-calculation method. $C_{1(2)}$ is the double-row radial value.

⁽²⁾Consult your Timken engineer for instructions on use or review the Timken Engineering Manual on timken.com/catalogs.

⁽³⁾Based on 90×10^6 revolutions L_{10} life, for The Timken Company life-calculation method. C_{90} and C_{a90} are radial and thrust values for a single row. $C_{90(2)}$ is the double-row radial value.

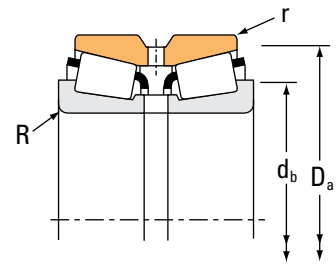
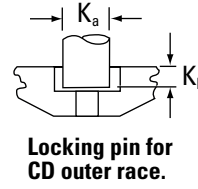
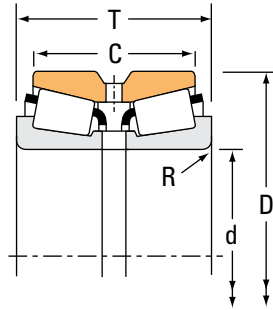
Part Number		Dimensions						Geometry Factors			Bearing Weight
Inner	Outer	Shaft		Housing		Pin		G ₁	G ₂	C _G	
		Max. Shaft Fillet Radius R ⁽⁴⁾	Backing Shoulder Dia. d _b	Max. Housing Fillet Radius r ⁽⁴⁾	Backing Shoulder Dia. D _a	K _a	K _b				
		mm in.	mm in.	mm in.	mm in.	mm in.	mm in.				kg lbs.
3782	3729D	3.5 0.14	58.0 2.28	0.8 0.03	87.9 3.46	– –	– –	49.9	14.5	0.0903	2.07 4.53
435	432D	0.8 0.03	52.0 2.05	0.8 0.03	87.0 3.43	– –	– –	42.5	11.3	0.0805	2.01 4.44
438	432D	3.5 0.14	57.0 2.24	0.8 0.03	87.0 3.43	– –	– –	42.5	11.3	0.0805	1.99 4.41
33885	33821D	0.8 0.03	53.0 2.09	0.8 0.03	90.0 3.54	– –	– –	52.5	18.5	0.0910	2.11 4.66
53177	53376D	3.5 0.14	63.0 2.48	0.8 0.03	89.0 3.50	– –	– –	26.7	9.6	0.0930	1.89 4.15
53178	53376D	2.0 0.08	60.0 2.36	0.8 0.03	89.0 3.50	– –	– –	26.7	9.6	0.0930	1.89 4.18
53177	53390D	3.5 0.14	63.0 2.48	1.5 0.06	90.0 3.54	– –	– –	26.7	9.6	0.0930	2.07 4.56
458	452D	0.8 0.03	55.0 2.17	0.8 0.03	100.0 3.94	– –	– –	58.6	17.1	0.0946	2.99 6.56
55175	55444D	3.5 0.14	67.0 2.64	1.5 0.06	105.0 4.13	– –	– –	36.8	13.2	0.1085	3.02 6.67
55176	55444D	0.8 0.03	61.0 2.40	1.5 0.06	105.0 4.13	– –	– –	36.8	13.2	0.1085	3.04 6.70
25584	25520D	1.5 0.06	53.0 2.09	0.8 0.03	77.0 3.03	– –	– –	35.2	14.3	0.0801	1.31 2.87
3776	3729D	3.5 0.14	59.0 2.32	0.8 0.03	87.9 3.46	– –	– –	49.9	14.5	0.0903	2.04 4.47
X32209	32209AD	1.5 0.06	54.0 2.13	0.8 0.03	81.0 3.19	– –	– –	30.5	13.8	0.0809	0.80 1.76
367	363D	2.0 0.08	55.0 2.17	0.8 0.03	84.0 3.31	– –	– –	33.8	14.0	0.0773	1.33 2.93
358	353D	1.5 0.06	53.0 2.09	0.8 0.03	82.0 3.23	– –	– –	30.0	12.2	0.0732	1.38 3.05
358A	353D	3.5 0.14	57.0 2.24	0.8 0.03	82.0 3.23	– –	– –	30.0	12.2	0.0732	1.39 3.04
25590	25520D	3.5 0.14	58.0 2.28	0.8 0.03	77.0 3.03	– –	– –	35.2	14.3	0.0801	1.27 2.80

⁽⁴⁾These maximum fillet radii will be cleared by bearing corners.
NOTE: For spacer configuration information, contact your Timken engineer.

TAPERED ROLLER BEARINGS

DOUBLE-ROW • TYPE TDO

TYPE TDO



Bearing Dimensions				Load Ratings							
Bore d	O.D. D	Width T	Double Outer Ring Width C	Dynamic ⁽¹⁾				Dynamic ⁽³⁾			
				C ₁₍₂₎	e	Y ₁	Y ₂	C ₉₀	C _{a90}	C ₉₀₍₂₎	K
mm in.	mm in.	mm in.	mm in.	N lbf				N lbf	N lbf	N lbf	
46.037 1.8125	79.375 3.1250	41.272 1.6249	33.338 1.3125	90600 20400	0.37	1.80	2.69	13500 3030	8630 1940	23500 5280	1.56
46.037 1.8125	90.119 3.5480	50.800 2.0000	44.450 1.7500	169000 38000	0.31	2.20	3.28	25100 5650	13200 2960	43800 9840	1.91
46.037 1.8125	95.250 3.7500	61.915 2.4376	50.800 2.0000	221000 49700	0.28	2.37	3.53	32900 7400	16000 3600	57300 12900	2.05
47.625 1.8750	90.000 3.5433	50.010 1.9689	42.070 1.6563	177000 39900	0.32	2.11	3.14	26400 5930	14400 3250	46000 10300	1.83
47.625 1.8750	90.000 3.5433	50.010 1.9689	42.070 1.6563	177000 39900	0.32	2.11	3.14	26400 5930	14400 3250	46000 10300	1.83
47.625 1.8750	93.264 3.6718	65.088 2.5625	52.388 2.0625	213000 47800	0.34	1.99	2.97	31700 7120	18300 4120	55100 12400	1.73
47.625 1.8750	100.000 3.9370	49.200 1.9370	39.675 1.5620	188000 42200	0.35	1.91	2.84	28000 6280	16900 3810	48700 10900	1.65
47.625 1.8750	100.000 3.9370	52.388 2.0625	42.862 1.6875	188000 42200	0.35	1.91	2.84	28000 6280	16900 3810	48700 10900	1.65
47.625 1.8750	107.950 4.2500	65.090 2.5626	53.975 2.1250	280000 62900	0.34	2.01	3.00	41700 9370	23900 5380	72600 16300	1.74
47.625 1.8750	109.982 4.3300	63.500 2.5000	42.865 1.6876	220000 49400	0.88	0.76	1.14	32700 7350	49500 11100	56900 12800	0.66
47.625 1.8750	112.712 4.4375	65.088 2.5625	46.038 1.8125	220000 49400	0.88	0.76	1.14	32700 7350	49500 11100	56900 12800	0.66
47.625 1.8750	117.475 4.6250	73.025 2.8750	53.975 2.1250	307000 69100	0.63	1.08	1.60	45800 10300	49100 11000	79700 17900	0.93
49.212 1.9375	93.264 3.6718	65.088 2.5625	52.388 2.0625	213000 47800	0.34	1.99	2.97	31700 7120	18300 4120	55100 12400	1.73
49.974 1.9675	109.982 4.3300	63.500 2.5000	42.865 1.6876	220000 49400	0.88	0.76	1.14	32700 7350	49500 11100	56900 12800	0.66
49.974 1.9675	112.712 4.4375	65.088 2.5625	46.038 1.8125	220000 49400	0.88	0.76	1.14	32700 7350	49500 11100	56900 12800	0.66
50.000 1.9685	90.000 3.5433	50.010 1.9689	42.070 1.6563	177000 39900	0.32	2.11	3.14	26400 5930	14400 3250	46000 10300	1.83
50.000 1.9685	90.000 3.5433	50.010 1.9689	42.070 1.6563	177000 39900	0.32	2.11	3.14	26400 5930	14400 3250	46000 10300	1.83

⁽¹⁾Based on 1×10^6 revolutions L_{10} life, for the ISO life-calculation method. $C_{1(2)}$ is the double-row radial value.

⁽²⁾Consult your Timken engineer for instructions on use or review the Timken Engineering Manual on timken.com/catalogs.

⁽³⁾Based on 90×10^6 revolutions L_{10} life, for The Timken Company life-calculation method. C_{90} and C_{a90} are radial and thrust values for a single row. $C_{90(2)}$ is the double-row radial value.

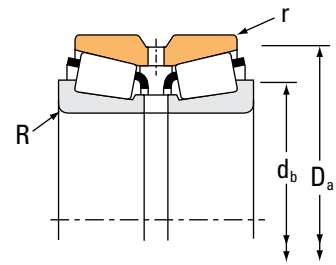
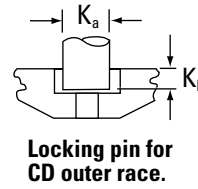
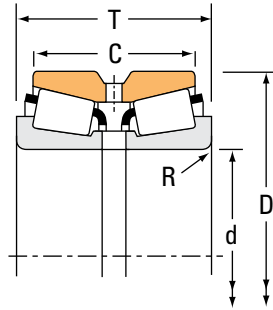
Part Number		Dimensions						Geometry Factors			Bearing Weight
Inner	Outer	Shaft		Housing		Pin		G ₁	G ₂	C _G	
		Max. Shaft Fillet Radius R ⁽⁴⁾	Backing Shoulder Dia. d _b	Max. Housing Fillet Radius r ⁽⁴⁾	Backing Shoulder Dia. D _a	K _a	K _b				
		mm in.	mm in.	mm in.	mm in.	mm in.	mm in.				kg lbs.
18690	18620D	2.8 0.11	56.0 2.20	0.8 0.03	74.0 2.91	– –	– –	23.9	18.7	0.0725	0.74 1.64
359-S	353D	2.3 0.09	55.0 2.17	0.8 0.03	82.0 3.23	– –	– –	30.0	12.2	0.0732	1.37 2.99
436	432D	3.5 0.14	59.0 2.32	0.8 0.03	87.0 3.43	– –	– –	42.5	11.3	0.0805	1.95 4.29
369A	363D	3.5 0.14	60.0 2.36	0.8 0.03	84.0 3.31	– –	– –	33.8	14.0	0.0773	1.27 2.78
369-S	363D	2.3 0.09	57.0 2.24	0.8 0.03	84.0 3.31	– –	– –	33.8	14.0	0.0773	1.27 2.79
3779	3729D	3.5 0.14	61.0 2.40	0.8 0.03	87.9 3.46	– –	– –	49.9	14.5	0.0903	1.94 4.27
386A	384ED	0.8 0.03	56.0 2.20	0.8 0.03	93.0 3.66	– –	– –	42.0	15.7	0.0859	1.73 3.78
386A	384D	0.8 0.03	56.0 2.20	0.8 0.03	93.0 3.66	– –	– –	42.0	15.7	0.0859	1.78 3.91
467	452D	0.8 0.03	57.0 2.24	0.8 0.03	100.0 3.94	– –	– –	58.6	17.1	0.0946	2.87 6.35
55187	55433D	3.5 0.14	69.0 2.72	0.5 0.02	105.0 4.13	– –	– –	36.8	13.2	0.1085	2.76 6.11
55187	55444D	3.5 0.14	69.0 2.72	1.5 0.06	105.0 4.13	– –	– –	36.8	13.2	0.1085	2.90 6.41
66187	66462D	3.5 0.14	69.0 2.72	0.8 0.03	111.0 4.37	– –	– –	50.2	16.4	0.0751	3.77 8.31
3781	3729D	3.5 0.14	62.0 2.44	0.8 0.03	87.9 3.46	– –	– –	49.9	14.5	0.0903	1.88 4.14
55197	55433D	2.0 0.08	68.0 2.68	0.5 0.02	105.0 4.13	– –	– –	36.8	13.2	0.1085	2.69 5.93
55197	55444D	2.0 0.08	68.0 2.68	1.5 0.06	105.0 4.13	– –	– –	36.8	13.2	0.1085	2.83 6.24
365	363D	2.0 0.08	58.0 2.28	0.8 0.03	84.0 3.31	– –	– –	33.8	14.0	0.0773	1.21 2.64
366	363D	2.3 0.09	59.0 2.32	0.8 0.03	84.0 3.31	– –	– –	33.8	14.0	0.0773	1.20 2.62

⁽⁴⁾These maximum fillet radii will be cleared by bearing corners.
NOTE: For spacer configuration information, contact your Timken engineer.

TAPERED ROLLER BEARINGS

DOUBLE-ROW • TYPE TDO

TYPE TDO



Bearing Dimensions				Load Ratings							
Bore d	O.D. D	Width T	Double Outer Ring Width C	Dynamic ⁽¹⁾				Dynamic ⁽³⁾			
				C ₁₍₂₎	e	Y ₁	Y ₂	C ₉₀	C _{a90}	C ₉₀₍₂₎	K
mm in.	mm in.	mm in.	mm in.	N lbf				N lbf	N lbf	N lbf	
50.000 1.9685	107.950 4.2500	65.090 2.5626	53.975 2.1250	280000 62900	0.34	2.01	3.00	41700 9370	23900 5380	72600 16300	1.74
50.000 1.9685	110.000 4.3307	52.388 2.0625	46.038 1.8125	172000 38700	0.40	1.68	2.50	25600 5760	17600 3970	44600 10000	1.45
50.800 2.0000	80.962 3.1875	42.865 1.6876	34.925 1.3750	106000 23800	0.36	1.90	2.83	15800 3540	9590 2160	27400 6170	1.64
50.800 2.0000	89.985 3.5427	50.400 1.9843	49.950 1.9665	177000 39900	0.32	2.11	3.14	26400 5930	14400 3250	46000 10300	1.83
50.800 2.0000	90.000 3.5433	50.010 1.9689	42.070 1.6563	177000 39900	0.32	2.11	3.14	26400 5930	14400 3250	46000 10300	1.83
50.800 2.0000	90.000 3.5433	50.010 1.9689	42.070 1.6563	177000 39900	0.32	2.11	3.14	26400 5930	14400 3250	46000 10300	1.83
50.800 2.0000	93.264 3.6718	65.088 2.5625	52.388 2.0625	213000 47800	0.34	1.99	2.97	31700 7120	18300 4120	55100 12400	1.73
50.800 2.0000	93.264 3.6718	65.088 2.5625	52.388 2.0625	213000 47800	0.34	1.99	2.97	31700 7120	18300 4120	55100 12400	1.73
50.800 2.0000	93.264 3.6718	65.088 2.5625	52.388 2.0625	213000 47800	0.34	1.99	2.97	31700 7120	18300 4120	55100 12400	1.73
50.800 2.0000	95.250 3.7500	63.500 2.5000	52.385 2.0624	226000 50800	0.33	2.05	3.05	33600 7560	19000 4270	58600 13200	1.77
50.800 2.0000	100.000 3.9370	49.200 1.9370	39.675 1.5620	188000 42200	0.35	1.91	2.84	28000 6280	16900 3810	48700 10900	1.65
50.800 2.0000	100.000 3.9370	52.388 2.0625	42.862 1.6875	188000 42200	0.35	1.91	2.84	28000 6280	16900 3810	48700 10900	1.65
50.800 2.0000	100.000 3.9370	52.388 2.0625	42.862 1.6875	188000 42200	0.35	1.91	2.84	28000 6280	16900 3810	48700 10900	1.65
50.800 2.0000	107.950 4.2500	65.090 2.5626	53.975 2.1250	280000 62900	0.34	2.01	3.00	41700 9370	23900 5380	72600 16300	1.74
50.800 2.0000	107.950 4.2500	65.090 2.5626	53.975 2.1250	280000 62900	0.34	2.01	3.00	41700 9370	23900 5380	72600 16300	1.74
50.800 2.0000	109.982 4.3300	63.500 2.5000	42.865 1.6876	220000 49400	0.88	0.76	1.14	32700 7350	49500 11100	56900 12800	0.66
50.800 2.0000	109.982 4.3300	63.500 2.5000	42.865 1.6876	263000 59200	0.88	0.76	1.14	39200 8810	59300 13300	68200 15300	0.66

⁽¹⁾Based on 1×10^6 revolutions L_{10} life, for the ISO life-calculation method. $C_{1(2)}$ is the double-row radial value.

⁽²⁾Consult your Timken engineer for instructions on use or review the Timken Engineering Manual on timken.com/catalogs.

⁽³⁾Based on 90×10^6 revolutions L_{10} life, for The Timken Company life-calculation method. C_{90} and C_{a90} are radial and thrust values for a single row. $C_{90(2)}$ is the double-row radial value.

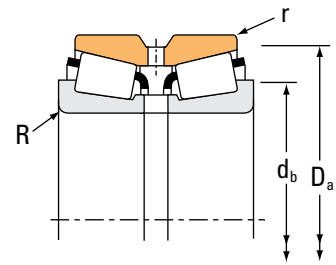
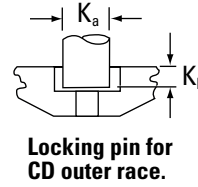
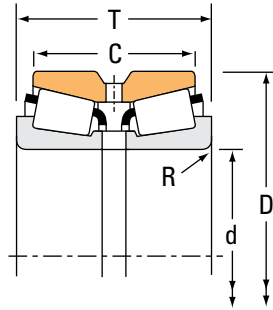
Part Number		Dimensions						Geometry Factors			Bearing Weight
Inner	Outer	Shaft		Housing		Pin		G ₁	G ₂	C _G	
		Max. Shaft Fillet Radius R ⁽⁴⁾	Backing Shoulder Dia. d _b	Max. Housing Fillet Radius r ⁽⁴⁾	Backing Shoulder Dia. D _a	K _a	K _b				
		mm in.	mm in.	mm in.	mm in.	mm in.	mm in.				kg lbs.
465	452D	2.3 0.09	62.0 2.44	0.8 0.03	100.0 3.94	– –	– –	58.6	17.1	0.0946	2.79 6.15
396	394D	0.8 0.03	61.0 2.40	0.8 0.03	104.4 4.11	– –	– –	56.0	21.4	0.0984	2.22 4.92
L305649	L305610D	1.5 0.06	58.0 2.28	0.8 0.03	77.0 3.03	– –	– –	38.8	29.8	0.0841	0.77 1.71
368A	362XD	3.5 0.14	62.0 2.44	0.5 0.02	86.3 3.40	– –	– –	33.8	14.0	0.0773	1.27 2.79
368	363D	1.5 0.06	58.0 2.28	0.8 0.03	84.0 3.31	– –	– –	33.8	14.0	0.0773	1.16 2.57
368A	363D	3.5 0.14	62.0 2.44	0.8 0.03	84.0 3.31	– –	– –	33.8	14.0	0.0773	1.17 2.56
3775	3729D	0.8 0.03	58.0 2.28	0.8 0.03	87.9 3.46	– –	– –	49.9	14.5	0.0903	1.83 4.03
3780	3729D	3.5 0.14	64.0 2.52	0.8 0.03	87.9 3.46	– –	– –	49.9	14.5	0.0903	1.82 4.02
3784	3729D	6.4 0.25	70.0 2.76	0.8 0.03	87.9 3.46	– –	– –	49.9	14.5	0.0903	1.78 3.93
33889	33821D	3.5 0.14	64.0 2.52	0.8 0.03	90.0 3.54	– –	– –	52.5	18.5	0.0910	1.86 4.08
385A	384ED	2.3 0.09	61.0 2.40	0.8 0.03	93.0 3.66	– –	– –	42.0	15.7	0.0859	1.60 3.52
385A	-	2.3 0.09	61.0 2.40	0.8 0.03	93.0 3.66	7.94 0.31	4.77 0.19	42.0	15.7	0.0859	1.70 3.76
385A	384CD	2.3 0.09	61.0 2.40	0.8 0.03	93.0 3.66	– –	– –	42.0	15.7	0.0859	1.71 3.77
455	452D	0.8 0.03	60.0 2.36	0.8 0.03	100.0 3.94	– –	– –	58.6	17.1	0.0946	2.75 6.04
455-S	452D	3.5 0.14	65.0 2.56	0.8 0.03	100.0 3.94	– –	– –	58.6	17.1	0.0946	2.75 6.05
55200	55433D	3.5 0.14	71.0 2.80	0.5 0.02	105.0 4.13	– –	– –	36.8	13.2	0.1085	2.67 5.90
55200C	55433D	3.5 0.14	71.0 2.80	0.5 0.02	105.0 4.13	– –	– –	48.7	18.1	0.1198	2.86 6.29

⁽⁴⁾These maximum fillet radii will be cleared by bearing corners.
NOTE: For spacer configuration information, contact your Timken engineer.

TAPERED ROLLER BEARINGS

DOUBLE-ROW • TYPE TDO

TYPE TDO



Bearing Dimensions				Load Ratings							
Bore d	O.D. D	Width T	Double Outer Ring Width C	Dynamic ⁽¹⁾		Factors ⁽²⁾		Dynamic ⁽³⁾			Factors ⁽²⁾
				C ₁₍₂₎	e	Y ₁	Y ₂	C ₉₀	C _{a90}	C ₉₀₍₂₎	K
mm in.	mm in.	mm in.	mm in.	N lbf				N lbf	N lbf	N lbf	
50.800 2.0000	110.000 4.3307	52.388 2.0625	46.038 1.8125	172000 38700	0.40	1.68	2.50	25600 5760	17600 3970	44600 10000	1.45
50.800 2.0000	112.712 4.4375	65.088 2.5625	46.038 1.8125	220000 49400	0.88	0.76	1.14	32700 7350	49500 11100	56900 12800	0.66
50.800 2.0000	117.475 4.6250	73.025 2.8750	53.975 2.1250	307000 69100	0.63	1.08	1.60	45800 10300	49100 11000	79700 17900	0.93
50.800 2.0000	123.825 4.8750	79.375 3.1250	63.500 2.5000	332000 74700	0.35	1.95	2.90	49400 11100	29300 6590	86100 19400	1.69
51.592 2.0312	90.000 3.5433	50.010 1.9689	42.070 1.6563	177000 39900	0.32	2.11	3.14	26400 5930	14400 3250	46000 10300	1.83
52.387 2.0625	93.264 3.6718	65.088 2.5625	52.388 2.0625	213000 47800	0.34	1.99	2.97	31700 7120	18300 4120	55100 12400	1.73
52.387 2.0625	95.250 3.7500	63.500 2.5000	52.385 2.0624	226000 50800	0.33	2.05	3.05	33600 7560	19000 4270	58600 13200	1.77
52.387 2.0625	95.250 3.7500	63.500 2.5000	52.385 2.0624	226000 50800	0.33	2.05	3.05	33600 7560	19000 4270	58600 13200	1.77
52.387 2.0625	107.950 4.2500	65.090 2.5626	53.975 2.1250	280000 62900	0.34	2.01	3.00	41700 9370	23900 5380	72600 16300	1.74
52.387 2.0625	109.982 4.3300	63.500 2.5000	42.865 1.6876	220000 49400	0.88	0.76	1.14	32700 7350	49500 11100	56900 12800	0.66
52.387 2.0625	112.712 4.4375	65.088 2.5625	46.038 1.8125	220000 49400	0.88	0.76	1.14	32700 7350	49500 11100	56900 12800	0.66
53.975 2.1250	95.250 3.7500	63.500 2.5000	52.385 2.0624	226000 50800	0.33	2.05	3.05	33600 7560	19000 4270	58600 13200	1.77
53.975 2.1250	100.000 3.9370	49.200 1.9370	39.675 1.5620	188000 42200	0.35	1.91	2.84	28000 6280	16900 3810	48700 10900	1.65
53.975 2.1250	100.000 3.9370	52.388 2.0625	42.862 1.6875	188000 42200	0.35	1.91	2.84	28000 6280	16900 3810	48700 10900	1.65
53.975 2.1250	107.950 4.2500	65.090 2.5626	53.975 2.1250	280000 62900	0.34	2.01	3.00	41700 9370	23900 5380	72600 16300	1.74
53.975 2.1250	111.125 4.3750	79.375 3.1250	63.500 2.5000	355000 79800	0.30	2.28	3.39	52900 11900	26800 6040	92100 20700	1.97
53.975 2.1250	117.475 4.6250	73.025 2.8750	53.975 2.1250	307000 69100	0.63	1.08	1.60	45800 10300	49100 11000	79700 17900	0.93

⁽¹⁾Based on 1 x 10⁶ revolutions L₁₀ life, for the ISO life-calculation method. C₁₍₂₎ is the double-row radial value.

⁽²⁾Consult your Timken engineer for instructions on use or review the Timken Engineering Manual on timken.com/catalogs.

⁽³⁾Based on 90 x 10⁶ revolutions L₁₀ life, for The Timken Company life-calculation method. C₉₀ and C_{a90} are radial and thrust values for a single row. C₉₀₍₂₎ is the double-row radial value.

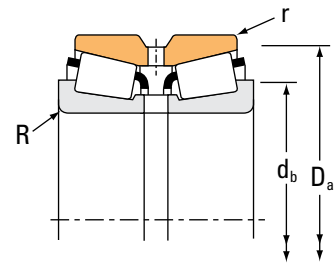
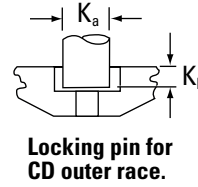
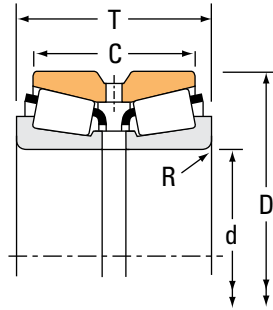
Part Number		Dimensions						Geometry Factors			Bearing Weight
Inner	Outer	Shaft		Housing		Pin		G ₁	G ₂	C _G	
		Max. Shaft Fillet Radius R ⁽⁴⁾	Backing Shoulder Dia. d _b	Max. Housing Fillet Radius r ⁽⁴⁾	Backing Shoulder Dia. D _a	K _a	K _b				
		mm in.	mm in.	mm in.	mm in.	mm in.	mm in.				kg lbs.
398	394D	0.8 0.03	62.0 2.44	0.8 0.03	104.4 4.11	– –	– –	56.0	21.4	0.0984	2.28 5.04
55200	55444D	3.5 0.14	71.0 2.80	1.5 0.06	105.0 4.13	– –	– –	36.8	13.2	0.1085	2.78 6.14
66200	66462D	3.5 0.14	71.0 2.80	0.8 0.03	111.0 4.37	– –	– –	50.2	16.4	0.0751	3.65 8.05
555	552D	2.3 0.09	66.0 2.60	1.5 0.06	115.0 4.53	– –	– –	91.0	21.1	0.1108	4.76 10.51
368-S	363D	2.0 0.08	59.0 2.32	0.8 0.03	84.0 3.31	– –	– –	33.8	14.0	0.0773	1.15 2.54
3767	3729D	2.3 0.09	63.0 2.48	0.8 0.03	87.9 3.46	– –	– –	49.9	14.5	0.0903	1.78 3.90
33890	33821D	1.5 0.06	61.0 2.40	0.8 0.03	90.0 3.54	– –	– –	52.5	18.5	0.0910	1.83 4.00
33891	33821D	3.5 0.14	66.0 2.60	0.8 0.03	90.0 3.54	– –	– –	52.5	18.5	0.0910	1.81 3.97
468	452D	1.5 0.06	62.0 2.44	0.8 0.03	100.0 3.94	– –	– –	58.6	17.1	0.0946	2.63 5.80
55206	55433D	3.5 0.14	72.0 2.83	0.5 0.02	105.0 4.13	– –	– –	36.8	13.2	0.1085	2.61 5.73
55206	55444D	3.5 0.14	72.0 2.83	1.5 0.06	105.0 4.13	– –	– –	36.8	13.2	0.1085	2.73 5.98
33895	33821D	1.5 0.06	63.0 2.48	0.8 0.03	90.0 3.54	– –	– –	52.5	18.5	0.0910	1.75 3.84
389A	384ED	0.8 0.03	61.0 2.40	0.8 0.03	93.0 3.66	– –	– –	42.0	15.7	0.0859	1.52 3.34
389A	384D	0.8 0.03	61.0 2.40	0.8 0.03	93.0 3.66	– –	– –	42.0	15.7	0.0859	1.60 3.52
456	452D	3.5 0.14	68.0 2.68	0.8 0.03	100.0 3.94	– –	– –	58.6	17.1	0.0946	2.61 5.74
539	533D	3.5 0.14	68.0 2.68	1.5 0.06	100.0 3.94	– –	– –	64.3	16.1	0.0938	3.33 7.35
66212	66462D	3.5 0.14	73.0 2.87	0.8 0.03	111.0 4.37	– –	– –	50.2	16.4	0.0751	3.58 7.87

⁽⁴⁾These maximum fillet radii will be cleared by bearing corners.
NOTE: For spacer configuration information, contact your Timken engineer.

TAPERED ROLLER BEARINGS

DOUBLE-ROW • TYPE TDO

TYPE TDO



Bearing Dimensions				Load Ratings							
Bore d	O.D. D	Width T	Double Outer Ring Width C	Dynamic ⁽¹⁾				Dynamic ⁽³⁾			
				C ₁₍₂₎	e	Y ₁	Y ₂	C ₉₀	C _{a90}	C ₉₀₍₂₎	K
mm in.	mm in.	mm in.	mm in.	N lbf				N lbf	N lbf	N lbf	
53.975 2.1250	123.825 4.8750	79.375 3.1250	63.500 2.5000	394000 88500	0.35	1.95	2.90	58600 13200	34700 7810	102000 22900	1.69
53.975 2.1250	139.700 5.5000	77.788 3.0625	51.803 2.0395	412000 92600	0.87	0.78	1.16	61300 13800	90900 20400	107000 24000	0.67
54.987 2.1649	107.950 4.2500	65.090 2.5626	53.975 2.1250	280000 62900	0.34	2.01	3.00	41700 9370	23900 5380	72600 16300	1.74
55.000 2.1654	100.000 3.9370	49.200 1.9370	39.675 1.5620	188000 42200	0.35	1.91	2.84	28000 6280	16900 3810	48700 10900	1.65
55.000 2.1654	100.000 3.9370	49.200 1.9370	39.675 1.5620	188000 42200	0.35	1.91	2.84	28000 6280	16900 3810	48700 10900	1.65
55.000 2.1654	100.000 3.9370	52.388 2.0625	42.862 1.6875	188000 42200	0.35	1.91	2.84	28000 6280	16900 3810	48700 10900	1.65
55.000 2.1654	100.000 3.9370	52.388 2.0625	42.862 1.6875	188000 42200	0.35	1.91	2.84	28000 6280	16900 3810	48700 10900	1.65
55.000 2.1654	120.000 4.7244	65.090 2.5626	53.975 2.1250	250000 56100	0.38	1.75	2.61	37200 8360	24500 5500	64700 14600	1.52
55.562 2.1875	107.950 4.2500	65.090 2.5626	53.975 2.1250	280000 62900	0.34	2.01	3.00	41700 9370	23900 5380	72600 16300	1.74
55.575 2.1880	100.000 3.9370	49.200 1.9370	39.675 1.5620	188000 42200	0.35	1.91	2.84	28000 6280	16900 3810	48700 10900	1.65
57.150 2.2500	92.075 3.6250	42.070 1.6563	34.130 1.3437	109000 24500	0.39	1.74	2.59	16300 3650	10800 2430	28300 6360	1.50
57.150 2.2500	100.000 3.9370	49.200 1.9370	39.675 1.5620	188000 42200	0.35	1.91	2.84	28000 6280	16900 3810	48700 10900	1.65
57.150 2.2500	100.000 3.9370	49.200 1.9370	39.675 1.5620	188000 42200	0.35	1.91	2.84	28000 6280	16900 3810	48700 10900	1.65
57.150 2.2500	100.000 3.9370	49.200 1.9370	39.675 1.5620	188000 42200	0.35	1.91	2.84	28000 6280	16900 3810	48700 10900	1.65
57.150 2.2500	100.000 3.9370	49.200 1.9370	39.675 1.5620	188000 42200	0.35	1.91	2.84	28000 6280	16900 3810	48700 10900	1.65
57.150 2.2500	100.000 3.9370	52.388 2.0625	42.862 1.6875	188000 42200	0.35	1.91	2.84	28000 6280	16900 3810	48700 10900	1.65
57.150 2.2500	100.000 3.9370	52.388 2.0625	42.862 1.6875	188000 42200	0.35	1.91	2.84	28000 6280	16900 3810	48700 10900	1.65

⁽¹⁾Based on 1×10^6 revolutions L_{10} life, for the ISO life-calculation method. $C_{1(2)}$ is the double-row radial value.

⁽²⁾Consult your Timken engineer for instructions on use or review the Timken Engineering Manual on timken.com/catalogs.

⁽³⁾Based on 90×10^6 revolutions L_{10} life, for The Timken Company life-calculation method. C_{90} and C_{a90} are radial and thrust values for a single row. $C_{90(2)}$ is the double-row radial value.

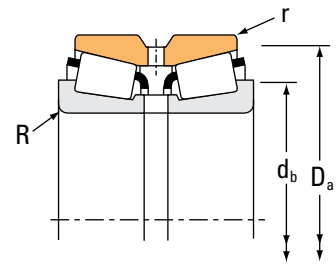
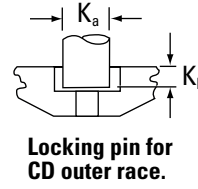
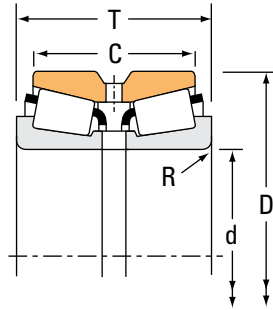
Part Number		Dimensions						Geometry Factors			Bearing Weight
Inner	Outer	Shaft		Housing		Pin		G ₁	G ₂	C _g	
		Max. Shaft Fillet Radius R ⁽⁴⁾	Backing Shoulder Dia. d _b	Max. Housing Fillet Radius r ⁽⁴⁾	Backing Shoulder Dia. D _a	K _a	K _b				
		mm in.	mm in.	mm in.	mm in.	mm in.	mm in.				kg lbs.
557-S	552D	3.5 0.14	73.0 2.87	1.5 0.06	115.0 4.53	– –	– –	91.0	21.1	0.1108	4.65 10.24
78215C	78549D	3.5 0.14	84.0 3.31	1.5 0.06	131.0 5.16	– –	– –	71.3	17.6	0.0926	5.81 12.80
466	452D	2.3 0.09	66.0 2.60	0.8 0.03	100.0 3.94	– –	– –	58.6	17.1	0.0946	2.59 5.68
385	384ED	2.3 0.09	65.0 2.56	0.8 0.03	93.0 3.66	– –	– –	42.0	15.7	0.0859	1.48 3.26
385X	384ED	3.5 0.14	67.0 2.64	0.8 0.03	93.0 3.66	– –	– –	42.0	15.7	0.0859	1.48 3.25
385	384D	2.3 0.09	65.0 2.56	0.8 0.03	93.0 3.66	– –	– –	42.0	15.7	0.0859	1.55 3.42
385X	384D	3.5 0.14	67.0 2.64	0.8 0.03	93.0 3.66	– –	– –	42.0	15.7	0.0859	1.55 3.41
475	472D	0.8 0.03	67.0 2.64	0.8 0.03	114.0 4.49	– –	– –	77.2	23.0	0.1083	3.65 8.05
466-S	452D	2.3 0.09	66.0 2.60	0.8 0.03	100.0 3.94	– –	– –	58.6	17.1	0.0946	2.55 5.63
389	384ED	2.3 0.09	65.0 2.56	0.8 0.03	93.0 3.66	– –	– –	42.0	15.7	0.0859	1.45 3.21
L507949	L507914D	1.5 0.06	65.0 2.56	0.8 0.03	86.0 3.39	– –	– –	46.1	38.5	0.0914	1.08 2.36
387	384ED	2.3 0.09	67.0 2.64	0.8 0.03	93.0 3.66	– –	– –	42.0	15.7	0.0859	1.41 3.09
387A	384ED	3.5 0.14	70.0 2.76	0.8 0.03	93.0 3.66	– –	– –	42.0	15.7	0.0859	1.42 3.11
387AS	384ED	5.0 0.20	73.0 2.87	0.8 0.03	93.0 3.66	– –	– –	42.0	15.7	0.0859	1.42 3.09
387-S	384ED	0.8 0.03	64.0 2.52	0.8 0.03	93.0 3.66	– –	– –	42.0	15.7	0.0859	1.42 3.13
387	384D	2.3 0.09	67.0 2.64	0.8 0.03	93.0 3.66	– –	– –	42.0	15.7	0.0859	1.49 3.28
387A	384D	3.5 0.14	70.0 2.76	0.8 0.03	93.0 3.66	– –	– –	42.0	15.7	0.0859	1.49 3.27

⁽⁴⁾These maximum fillet radii will be cleared by bearing corners.
NOTE: For spacer configuration information, contact your Timken engineer.

TAPERED ROLLER BEARINGS

DOUBLE-ROW • TYPE TDO

TYPE TDO



Bearing Dimensions				Load Ratings							
Bore d	O.D. D	Width T	Double Outer Ring Width C	Dynamic ⁽¹⁾				Dynamic ⁽³⁾			
				C ₁₍₂₎	e	Y ₁	Y ₂	C ₉₀	C _{a90}	C ₉₀₍₂₎	K
mm in.	mm in.	mm in.	mm in.	N lbf				N lbf	N lbf	N lbf	
57.150 2.2500	100.000 3.9370	52.388 2.0625	42.862 1.6875	188000 42200	0.35	1.91	2.84	28000 6280	16900 3810	48700 10900	1.65
57.150 2.2500	100.000 3.9370	52.388 2.0625	42.862 1.6875	188000 42200	0.35	1.91	2.84	28000 6280	16900 3810	48700 10900	1.65
57.150 2.2500	100.000 3.9370	105.131 4.1390	95.606 3.7640	188000 42200	0.35	1.91	2.84	28000 6280	16900 3810	48700 10900	1.65
57.150 2.2500	107.950 4.2500	65.090 2.5626	53.975 2.1250	280000 62900	0.34	2.01	3.00	41700 9370	23900 5380	72600 16300	1.74
57.150 2.2500	107.950 4.2500	65.090 2.5626	53.975 2.1250	280000 62900	0.34	2.01	3.00	41700 9370	23900 5380	72600 16300	1.74
57.150 2.2500	110.000 4.3307	52.388 2.0625	46.038 1.8125	172000 38700	0.40	1.68	2.50	25600 5760	17600 3970	44600 10000	1.45
57.150 2.2500	114.287 4.4995	58.738 2.3125	46.038 1.8125	192000 43300	0.49	1.38	2.06	28600 6440	23900 5370	49900 11200	1.20
57.150 2.2500	117.475 4.6250	66.675 2.6250	53.975 2.1250	241000 54200	0.44	1.55	2.31	35900 8060	26800 6020	62400 14000	1.34
57.150 2.2500	117.475 4.6250	73.025 2.8750	53.975 2.1250	307000 69100	0.63	1.08	1.60	45800 10300	49100 11000	79700 17900	0.93
57.150 2.2500	123.825 4.8750	77.788 3.0625	55.562 2.1875	373000 83900	0.74	0.92	1.36	55500 12500	70100 15800	96700 21700	0.79
57.150 2.2500	123.825 4.8750	79.375 3.1250	63.500 2.5000	394000 88500	0.35	1.95	2.90	58600 13200	34700 7810	102000 22900	1.69
57.150 2.2500	136.525 5.3750	95.250 3.7500	76.200 3.0000	406000 91200	0.36	1.86	2.78	60400 13600	37400 8420	105000 23600	1.61
57.150 2.2500	139.700 5.5000	77.788 3.0625	51.803 2.0395	353000 79300	0.87	0.78	1.16	52600 11800	77900 17500	91500 20600	0.67
57.531 2.2650	100.000 3.9370	49.200 1.9370	39.675 1.5620	188000 42200	0.35	1.91	2.84	28000 6280	16900 3810	48700 10900	1.65
57.531 2.2650	100.000 3.9370	52.388 2.0625	42.862 1.6875	188000 42200	0.35	1.91	2.84	28000 6280	16900 3810	48700 10900	1.65
59.972 2.3611	129.982 5.1174	69.850 2.7500	47.625 1.8750	319000 71700	0.67	1.01	1.51	47500 10700	54100 12200	82700 18600	0.88
59.977 2.3613	100.000 3.9370	55.560 2.1874	44.450 1.7500	185000 41500	0.43	1.59	2.36	27500 6180	20000 4500	47900 10800	1.37

⁽¹⁾Based on 1 x 10⁶ revolutions L₁₀ life, for the ISO life-calculation method. C₁₍₂₎ is the double-row radial value.

⁽²⁾Consult your Timken engineer for instructions on use or review the Timken Engineering Manual on timken.com/catalogs.

⁽³⁾Based on 90 x 10⁶ revolutions L₁₀ life, for The Timken Company life-calculation method. C₉₀ and C_{a90} are radial and thrust values for a single row. C₉₀₍₂₎ is the double-row radial value.

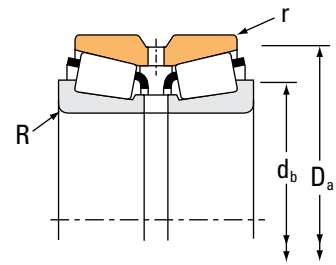
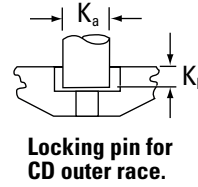
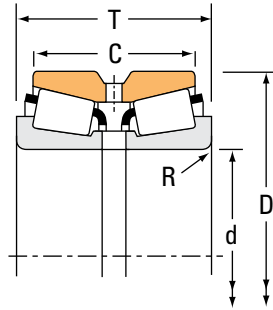
Part Number		Dimensions						Geometry Factors			Bearing Weight
Inner	Outer	Shaft		Housing		Pin		G ₁	G ₂	C _G	
		Max. Shaft Fillet Radius R ⁽⁴⁾	Backing Shoulder Dia. d _b	Max. Housing Fillet Radius r ⁽⁴⁾	Backing Shoulder Dia. D _a	K _a	K _b				
		mm in.	mm in.	mm in.	mm in.	mm in.	mm in.				kg lbs.
387AS	384D	5.0 0.20	73.0 2.87	0.8 0.03	93.0 3.66	– –	– –	42.0	15.7	0.0859	1.49 3.25
387-S	384D	0.8 0.03	64.0 2.52	0.8 0.03	93.0 3.66	– –	– –	42.0	15.7	0.0859	1.49 3.29
387A	384XD	3.5 0.14	70.0 2.76	0.8 0.03	94.0 3.70	– –	– –	42.0	15.7	0.0859	2.92 6.42
462	452D	2.3 0.09	67.0 2.64	0.8 0.03	100.0 3.94	– –	– –	58.6	17.1	0.0946	2.48 5.48
469	452D	3.5 0.14	72.0 2.83	0.8 0.03	100.0 3.94	– –	– –	58.6	17.1	0.0946	2.48 5.47
390	394D	2.3 0.09	70.0 2.76	0.8 0.03	104.4 4.11	– –	– –	56.0	21.4	0.0984	2.08 4.58
29665	29622D	3.5 0.14	75.0 2.95	0.8 0.03	109.0 4.29	– –	– –	77.7	43.3	0.1170	2.76 6.07
33225	33462D	3.5 0.14	74.0 2.91	0.8 0.03	112.0 4.41	– –	– –	84.2	25.9	0.1162	3.43 7.57
66225	66462D	3.5 0.14	76.0 2.99	0.8 0.03	111.0 4.37	– –	– –	50.2	16.4	0.0751	3.35 7.37
72225C	72488D	3.5 0.14	81.0 3.19	1.5 0.06	115.0 4.53	– –	– –	57.4	15.9	0.0825	4.14 9.13
555-S	552D	3.5 0.14	76.0 2.99	1.5 0.06	115.0 4.53	– –	– –	91.0	21.1	0.1108	4.48 9.88
635	632D	3.5 0.14	75.0 2.95	1.5 0.06	125.0 4.92	– –	– –	106.4	21.0	0.0814	6.76 14.88
78225	78549D	3.5 0.14	83.0 3.27	1.5 0.06	131.0 5.16	– –	– –	62.6	19.1	0.0884	5.40 11.91
388A	384ED	3.5 0.14	70.0 2.76	0.8 0.03	93.0 3.66	– –	– –	42.0	15.7	0.0859	1.44 3.17
388A	384D	3.5 0.14	70.0 2.76	0.8 0.03	93.0 3.66	– –	– –	42.0	15.7	0.0859	1.46 3.23
66589	66522D	0.8 0.03	74.0 2.91	0.8 0.03	118.0 4.65	– –	– –	57.0	18.3	0.0797	3.94 8.68
28980	28921D	3.5 0.14	73.0 2.87	0.8 0.03	96.0 3.78	– –	– –	60.1	24.5	0.1032	1.67 3.67

⁽⁴⁾These maximum fillet radii will be cleared by bearing corners.
NOTE: For spacer configuration information, contact your Timken engineer.

TAPERED ROLLER BEARINGS

DOUBLE-ROW • TYPE TDO

TYPE TDO



Bearing Dimensions				Load Ratings							
Bore d	O.D. D	Width T	Double Outer Ring Width C	Dynamic ⁽¹⁾		Factors ⁽²⁾		Dynamic ⁽³⁾			Factors ⁽²⁾
				C ₁₍₂₎	e	Y ₁	Y ₂	C ₉₀	C _{a90}	C ₉₀₍₂₎	K
mm in.	mm in.	mm in.	mm in.	N lbf				N lbf	N lbf	N lbf	
59.987 2.3617	123.825 4.8750	79.375 3.1250	63.500 2.5000	332000 74700	0.35	1.95	2.90	49400 11100	29300 6590	86100 19400	1.69
60.000 2.3622	110.000 4.3307	52.388 2.0625	46.038 1.8125	172000 38700	0.40	1.68	2.50	25600 5760	17600 3970	44600 10000	1.45
60.000 2.3622	120.000 4.7244	65.090 2.5626	53.975 2.1250	250000 56100	0.38	1.75	2.61	37200 8360	24500 5500	64700 14600	1.52
60.000 2.3622	129.982 5.1174	69.850 2.7500	47.625 1.8750	319000 71700	0.67	1.01	1.51	47500 10700	54100 12200	82700 18600	0.88
60.325 2.3750	100.000 3.9370	55.560 2.1874	44.450 1.7500	185000 41500	0.43	1.59	2.36	27500 6180	20000 4500	47900 10800	1.37
60.325 2.3750	123.825 4.8750	79.375 3.1250	63.500 2.5000	394000 88500	0.35	1.95	2.90	58600 13200	34700 7810	102000 22900	1.69
60.325 2.3750	123.825 4.8750	79.375 3.1250	63.500 2.5000	332000 74700	0.35	1.95	2.90	49400 11100	29300 6590	86100 19400	1.69
60.325 2.3750	136.525 5.3750	95.250 3.7500	76.200 3.0000	406000 91200	0.36	1.86	2.78	60400 13600	37400 8420	105000 23600	1.61
61.912 2.4375	110.000 4.3307	52.388 2.0625	46.038 1.8125	172000 38700	0.40	1.68	2.50	25600 5760	17600 3970	44600 10000	1.45
61.912 2.4375	123.825 4.8750	79.375 3.1250	63.500 2.5000	332000 74700	0.35	1.95	2.90	49400 11100	29300 6590	86100 19400	1.69
62.737 2.4700	100.000 3.9370	55.560 2.1874	44.450 1.7500	185000 41500	0.43	1.59	2.36	27500 6180	20000 4500	47900 10800	1.37
63.500 2.5000	94.458 3.7188	42.860 1.6874	34.925 1.3750	117000 26200	0.42	1.59	2.37	17400 3910	12600 2840	30200 6800	1.38
63.500 2.5000	110.000 4.3307	52.388 2.0625	46.038 1.8125	172000 38700	0.40	1.68	2.50	25600 5760	17600 3970	44600 10000	1.45
63.500 2.5000	110.000 4.3307	52.388 2.0625	46.038 1.8125	172000 38700	0.40	1.68	2.50	25600 5760	17600 3970	44600 10000	1.45
63.500 2.5000	112.712 4.4375	55.562 2.1875	42.862 1.6875	227000 51100	0.46	1.47	2.19	33800 7610	26600 5970	58900 13200	1.27
63.500 2.5000	117.475 4.6250	66.675 2.6250	53.975 2.1250	241000 54200	0.44	1.55	2.31	35900 8060	26800 6020	62400 14000	1.34
63.500 2.5000	120.000 4.7244	65.090 2.5626	53.975 2.1250	250000 56100	0.38	1.75	2.61	37200 8360	24500 5500	64700 14600	1.52

⁽¹⁾Based on 1 x 10⁶ revolutions L₁₀ life, for the ISO life-calculation method. C₁₍₂₎ is the double-row radial value.

⁽²⁾Consult your Timken engineer for instructions on use or review the Timken Engineering Manual on timken.com/catalogs.

⁽³⁾Based on 90 x 10⁶ revolutions L₁₀ life, for The Timken Company life-calculation method. C₉₀ and C_{a90} are radial and thrust values for a single row. C₉₀₍₂₎ is the double-row radial value.

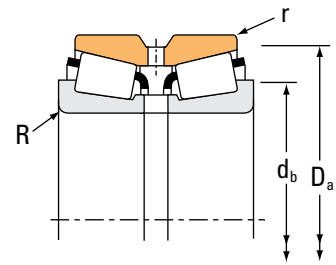
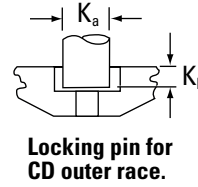
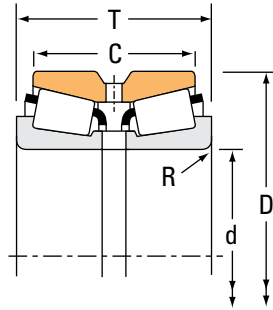
Part Number		Dimensions						Geometry Factors			Bearing Weight
Inner	Outer	Shaft		Housing		Pin		G ₁	G ₂	C _G	
		Max. Shaft Fillet Radius R ⁽⁴⁾	Backing Shoulder Dia. d _b	Max. Housing Fillet Radius r ⁽⁴⁾	Backing Shoulder Dia. D _a	K _a	K _b				
		mm in.	mm in.	mm in.	mm in.	mm in.	mm in.				kg lbs.
558-S	552D	3.5 0.14	75.0 2.95	1.5 0.06	115.0 4.53	– –	– –	91.0	21.1	0.1108	4.31 9.50
397	394D	0.8 0.03	69.0 2.72	0.8 0.03	104.4 4.11	– –	– –	56.0	21.4	0.0984	2.02 4.43
476	472D	2.0 0.08	73.0 2.87	0.8 0.03	114.0 4.49	– –	– –	77.2	23.0	0.1083	3.43 7.54
66585	66522D	3.5 0.14	79.0 3.11	0.8 0.03	118.0 4.65	– –	– –	57.0	18.3	0.0797	3.92 8.64
28985	28921D	3.5 0.14	73.0 2.87	0.8 0.03	96.0 3.78	– –	– –	60.1	24.5	0.1032	1.64 3.62
558	552D	2.3 0.09	76.0 2.99	1.5 0.06	115.0 4.53	– –	– –	91.0	21.1	0.1108	4.32 9.50
558A	552D	3.5 0.14	76.0 2.99	1.5 0.06	115.0 4.53	– –	– –	91.0	21.1	0.1108	4.30 9.47
637	632D	3.5 0.14	78.0 3.07	1.5 0.06	125.0 4.92	– –	– –	106.4	21.0	0.0814	6.55 14.40
392	394D	0.8 0.03	70.0 2.76	0.8 0.03	104.4 4.11	– –	– –	56.0	21.4	0.0984	1.96 4.35
554	552D	3.5 0.14	77.0 3.03	1.5 0.06	115.0 4.53	– –	– –	91.0	21.1	0.1108	4.19 9.26
28995	28921D	3.5 0.14	75.0 2.95	0.8 0.03	96.0 3.78	– –	– –	60.1	24.5	0.1032	1.54 3.42
L610549	L610510D	1.5 0.06	71.0 2.80	0.8 0.03	91.0 3.58	– –	– –	56.7	50.3	0.1006	0.99 2.17
395	394D	3.5 0.14	77.0 3.03	0.8 0.03	104.4 4.11	– –	– –	56.0	21.4	0.0984	1.86 4.12
390A	394D	1.5 0.06	73.0 2.87	0.8 0.03	104.4 4.11	– –	– –	56.0	21.4	0.0984	1.90 4.18
29586	29526D	1.5 0.06	73.0 2.87	0.8 0.03	105.0 4.13	– –	– –	70.3	25.9	0.1112	2.19 4.81
33251	33462D	0.8 0.03	73.0 2.87	0.8 0.03	112.0 4.41	– –	– –	84.2	25.9	0.1162	3.18 7.02
477	472D	0.8 0.03	73.0 2.87	0.8 0.03	114.0 4.49	– –	– –	77.2	23.0	0.1083	3.25 7.17

⁽⁴⁾These maximum fillet radii will be cleared by bearing corners.
NOTE: For spacer configuration information, contact your Timken engineer.

TAPERED ROLLER BEARINGS

DOUBLE-ROW • TYPE TDO

TYPE TDO



Bearing Dimensions				Load Ratings							
Bore d	O.D. D	Width T	Double Outer Ring Width C	Dynamic ⁽¹⁾		Factors ⁽²⁾		Dynamic ⁽³⁾			Factors ⁽²⁾
				C ₁₍₂₎	e	Y ₁	Y ₂	C ₉₀	C _{a90}	C ₉₀₍₂₎	K
mm in.	mm in.	mm in.	mm in.	N lbf				N lbf	N lbf	N lbf	
63.500 2.5000	120.000 4.7244	65.090 2.5626	53.975 2.1250	250000 56100	0.38	1.75	2.61	37200 8360	24500 5500	64700 14600	1.52
63.500 2.5000	123.825 4.8750	79.375 3.1250	63.500 2.5000	394000 88500	0.35	1.95	2.90	58600 13200	34700 7810	102000 22900	1.69
63.500 2.5000	127.000 5.0000	80.962 3.1875	65.088 2.5625	342000 76900	0.36	1.86	2.76	50900 11400	31700 7130	88600 19900	1.61
63.500 2.5000	136.525 5.3750	95.250 3.7500	76.200 3.0000	481000 108000	0.36	1.86	2.78	71600 16100	44400 9980	125000 28000	1.61
63.500 2.5000	139.700 5.5000	77.788 3.0625	51.803 2.0395	353000 79300	0.87	0.78	1.16	52600 11800	77900 17500	91500 20600	0.67
63.500 2.5000	155.575 6.1250	101.600 4.0000	85.725 3.3750	656000 147000	0.33	2.08	3.09	97600 21900	54400 12200	170000 38200	1.80
64.960 2.5575	155.575 6.1250	101.600 4.0000	85.725 3.3750	553000 124000	0.33	2.08	3.09	82400 18500	45900 10300	143000 32200	1.80
64.963 2.5576	127.000 5.0000	80.962 3.1875	65.088 2.5625	342000 76900	0.36	1.86	2.76	50900 11400	31700 7130	88600 19900	1.61
64.987 2.5586	139.700 5.5000	77.788 3.0625	51.803 2.0395	353000 79300	0.87	0.78	1.16	52600 11800	77900 17500	91500 20600	0.67
65.000 2.5591	120.000 4.7244	65.090 2.5626	53.975 2.1250	250000 56100	0.38	1.75	2.61	37200 8360	24500 5500	64700 14600	1.52
66.675 2.6250	110.000 4.3307	52.388 2.0625	46.038 1.8125	172000 38700	0.40	1.68	2.50	25600 5760	17600 3970	44600 10000	1.45
66.675 2.6250	110.000 4.3307	52.388 2.0625	46.038 1.8125	172000 38700	0.40	1.68	2.50	25600 5760	17600 3970	44600 10000	1.45
66.675 2.6250	117.475 4.6250	66.675 2.6250	53.975 2.1250	241000 54200	0.44	1.55	2.31	35900 8060	26800 6020	62400 14000	1.34
66.675 2.6250	120.000 4.7244	65.090 2.5626	53.975 2.1250	250000 56100	0.38	1.75	2.61	37200 8360	24500 5500	64700 14600	1.52
66.675 2.6250	123.825 4.8750	79.375 3.1250	63.500 2.5000	394000 88500	0.35	1.95	2.90	58600 13200	34700 7810	102000 22900	1.69
66.675 2.6250	136.525 5.3750	95.250 3.7500	76.200 3.0000	481000 108000	0.36	1.86	2.78	71600 16100	44400 9980	125000 28000	1.61
68.262 2.6875	110.000 4.3307	52.388 2.0625	46.038 1.8125	172000 38700	0.40	1.68	2.50	25600 5760	17600 3970	44600 10000	1.45

⁽¹⁾Based on 1 x 10⁶ revolutions L₁₀ life, for the ISO life-calculation method. C₁₍₂₎ is the double-row radial value.

⁽²⁾Consult your Timken engineer for instructions on use or review the Timken Engineering Manual on timken.com/catalogs.

⁽³⁾Based on 90 x 10⁶ revolutions L₁₀ life, for The Timken Company life-calculation method. C₉₀ and C_{a90} are radial and thrust values for a single row. C₉₀₍₂₎ is the double-row radial value.

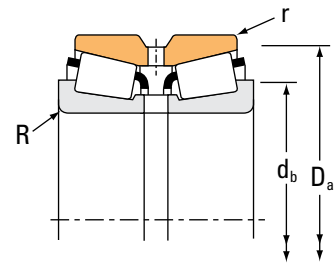
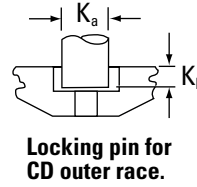
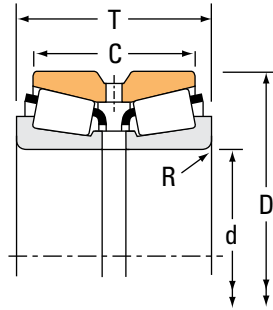
Part Number		Dimensions						Geometry Factors			Bearing Weight
Inner	Outer	Shaft		Housing		Pin		G ₁	G ₂	C _G	
		Max. Shaft Fillet Radius R ⁽⁴⁾	Backing Shoulder Dia. d _b	Max. Housing Fillet Radius r ⁽⁴⁾	Backing Shoulder Dia. D _a	K _a	K _b				
		mm in.	mm in.	mm in.	mm in.	mm in.	mm in.				kg lbs.
483	472D	3.5 0.14	78.0 3.07	0.8 0.03	114.0 4.49	– –	– –	77.2	23.0	0.1083	3.25 7.19
559	552D	3.5 0.14	81.0 3.19	1.5 0.06	115.0 4.53	– –	– –	91.0	21.1	0.1108	4.25 9.40
565	563D	3.5 0.14	80.0 3.15	1.5 0.06	119.0 4.69	– –	– –	101.3	24.0	0.1167	4.53 9.99
639	632D	3.5 0.14	81.0 3.19	1.5 0.06	125.0 4.92	– –	– –	106.4	21.0	0.0814	6.28 13.82
78250	78549D	2.3 0.09	85.0 3.35	1.5 0.06	131.0 5.16	– –	– –	62.6	19.1	0.0884	5.10 11.24
745-S	742D	3.5 0.14	84.0 3.31	1.5 0.06	143.0 5.63	– –	– –	159.6	26.3	0.0898	9.77 21.54
747-S	742D	3.5 0.14	85.0 3.35	1.5 0.06	143.0 5.63	– –	– –	159.6	26.3	0.0898	9.74 21.47
569	563D	3.5 0.14	81.0 3.19	1.5 0.06	119.0 4.69	– –	– –	101.3	24.0	0.1167	4.43 9.79
78255X	78549D	3.5 0.14	89.0 3.50	1.5 0.06	131.0 5.16	– –	– –	62.6	19.1	0.0884	4.99 11.00
478	472D	2.3 0.09	77.0 3.03	0.8 0.03	114.0 4.49	– –	– –	77.2	23.0	0.1083	3.17 7.00
395A	394D	0.8 0.03	73.0 2.87	0.8 0.03	104.4 4.11	– –	– –	56.0	21.4	0.0984	1.76 3.89
395-S	394D	3.5 0.14	79.0 3.11	0.8 0.03	104.4 4.11	– –	– –	56.0	21.4	0.0984	1.76 3.88
33262	33462D	3.5 0.14	81.0 3.19	0.8 0.03	112.0 4.41	– –	– –	84.2	25.9	0.1162	2.95 6.52
479	472D	2.3 0.09	78.0 3.07	0.8 0.03	114.0 4.49	– –	– –	77.2	23.0	0.1083	3.11 6.83
560	552D	3.5 0.14	84.0 3.31	1.5 0.06	115.0 4.53	– –	– –	91.0	21.1	0.1108	3.89 8.59
641	632D	3.5 0.14	83.0 3.27	1.5 0.06	125.0 4.92	– –	– –	106.4	21.0	0.0814	6.06 13.35
399A	394D	2.3 0.09	78.0 3.07	0.8 0.03	104.4 4.11	– –	– –	56.0	21.4	0.0984	1.69 3.72

⁽⁴⁾These maximum fillet radii will be cleared by bearing corners.
NOTE: For spacer configuration information, contact your Timken engineer.

TAPERED ROLLER BEARINGS

DOUBLE-ROW • TYPE TDO

TYPE TDO



Bearing Dimensions				Load Ratings							
Bore d	O.D. D	Width T	Double Outer Ring Width C	Dynamic ⁽¹⁾				Dynamic ⁽³⁾			
				C ₁₍₂₎	e	Y ₁	Y ₂	C ₉₀	C _{a90}	C ₉₀₍₂₎	K
mm in.	mm in.	mm in.	mm in.	N lbf				N lbf	N lbf	N lbf	
68.262 2.6875	110.000 4.3307	52.388 2.0625	46.038 1.8125	172000 38700	0.40	1.68	2.50	25600 5760	17600 3970	44600 10000	1.45
68.262 2.6875	120.000 4.7244	65.090 2.5626	53.975 2.1250	250000 56100	0.38	1.75	2.61	37200 8360	24500 5500	64700 14600	1.52
68.262 2.6875	123.825 4.8750	79.375 3.1250	63.500 2.5000	332000 74700	0.35	1.95	2.90	49400 11100	29300 6590	86100 19400	1.69
68.262 2.6875	127.000 5.0000	80.962 3.1875	65.088 2.5625	342000 76900	0.36	1.86	2.76	50900 11400	31700 7130	88600 19900	1.61
68.262 2.6875	136.525 5.3750	95.250 3.7500	76.200 3.0000	406000 91200	0.36	1.86	2.78	60400 13600	37400 8420	105000 23600	1.61
68.262 2.6875	161.925 6.3750	105.562 4.1560	70.637 2.7810	614000 138000	0.71	0.95	1.42	91400 20600	111000 24900	159000 35800	0.82
69.850 2.7500	114.287 4.4995	58.738 2.3125	46.038 1.8125	192000 43300	0.49	1.38	2.06	28600 6440	23900 5370	49900 11200	1.20
69.850 2.7500	117.475 4.6250	66.675 2.6250	53.975 2.1250	241000 54200	0.44	1.55	2.31	35900 8060	26800 6020	62400 14000	1.34
69.850 2.7500	120.000 4.7244	65.090 2.5626	53.975 2.1250	250000 56100	0.38	1.75	2.61	37200 8360	24500 5500	64700 14600	1.52
69.850 2.7500	120.000 4.7244	71.438 2.8125	58.738 2.3125	311000 70000	0.36	1.87	2.79	46300 10400	28600 6420	80700 18100	1.62
69.850 2.7500	127.000 5.0000	80.962 3.1875	65.088 2.5625	342000 76900	0.36	1.86	2.76	50900 11400	31700 7130	88600 19900	1.61
69.850 2.7500	136.525 5.3750	95.250 3.7500	76.200 3.0000	481000 108000	0.36	1.86	2.78	71600 16100	44400 9980	125000 28000	1.61
69.850 2.7500	152.400 6.0000	95.250 3.7500	76.200 3.0000	430000 96700	0.41	1.65	2.46	64000 14400	44800 10100	112000 25100	1.43
69.850 2.7500	155.575 6.1250	101.600 4.0000	85.725 3.3750	553000 124000	0.33	2.08	3.09	82400 18500	45900 10300	143000 32200	1.80
69.850 2.7500	155.575 6.1250	101.600 4.0000	85.725 3.3750	656000 147000	0.33	2.08	3.09	97600 21900	54400 12200	170000 38200	1.80
69.850 2.7500	171.450 6.7500	125.412 4.9375	100.012 3.9375	844000 190000	0.30	2.26	3.36	126000 28300	64400 14500	219000 49200	1.95
69.914 2.7525	177.800 7.0000	109.538 4.3125	74.612 2.9375	632000 142000	0.76	0.88	1.31	94100 21200	123000 27700	164000 36800	0.76

⁽¹⁾Based on 1 x 10⁶ revolutions L₁₀ life, for the ISO life-calculation method. C₁₍₂₎ is the double-row radial value.

⁽²⁾Consult your Timken engineer for instructions on use or review the Timken Engineering Manual on timken.com/catalogs.

⁽³⁾Based on 90 x 10⁶ revolutions L₁₀ life, for The Timken Company life-calculation method. C₉₀ and C_{a90} are radial and thrust values for a single row. C₉₀₍₂₎ is the double-row radial value.

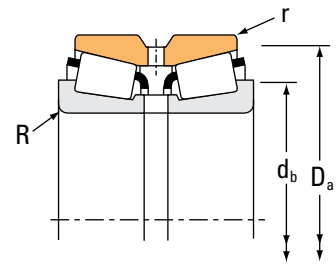
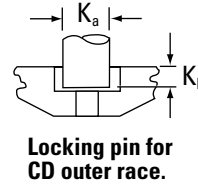
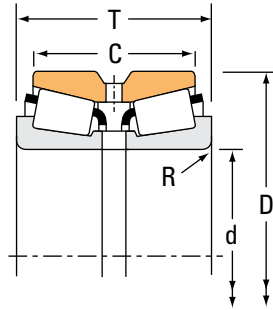
Part Number		Dimensions						Geometry Factors			Bearing Weight
Inner	Outer	Shaft		Housing		Pin		G ₁	G ₂	C _G	
		Max. Shaft Fillet Radius R ⁽⁴⁾	Backing Shoulder Dia. d _b	Max. Housing Fillet Radius r ⁽⁴⁾	Backing Shoulder Dia. D _a	K _a	K _b				
		mm in.	mm in.	mm in.	mm in.	mm in.	mm in.				kg lbs.
399AS	394D	5.0 0.20	83.0 3.27	0.8 0.03	104.4 4.11	– –	– –	56.0	21.4	0.0984	1.65 3.64
480	472D	3.5 0.14	82.0 3.23	0.8 0.03	114.0 4.49	– –	– –	77.2	23.0	0.1083	2.98 6.58
560-S	552D	3.5 0.14	83.0 3.27	1.5 0.06	115.0 4.53	– –	– –	91.0	21.1	0.1108	3.79 8.35
570	563D	3.5 0.14	83.0 3.27	1.5 0.06	119.0 4.69	– –	– –	101.3	24.0	0.1167	4.23 9.31
642	632D	3.5 0.14	85.0 3.35	1.5 0.06	125.0 4.92	– –	– –	106.4	21.0	0.0814	5.93 13.04
9278	9220D	3.5 0.14	106.0 4.17	0.8 0.03	153.0 6.03	– –	– –	102.5	16.1	0.0984	9.42 20.77
29675	29622D	1.5 0.06	80.0 3.15	0.8 0.03	109.0 4.29	– –	– –	77.7	43.3	0.1170	2.20 4.86
33275	33462D	3.5 0.14	85.0 3.35	0.8 0.03	112.0 4.41	– –	– –	84.2	25.9	0.1162	2.81 6.20
482	472D	3.5 0.14	83.0 3.27	0.8 0.03	114.0 4.49	– –	– –	77.2	23.0	0.1083	2.90 6.40
47487	47420D	3.5 0.14	84.0 3.31	0.8 0.03	114.0 4.49	– –	– –	98.4	26.3	0.1153	3.12 6.86
566	563D	3.5 0.14	85.0 3.35	1.5 0.06	119.0 4.69	– –	– –	101.3	24.0	0.1167	4.12 9.07
643	632D	3.5 0.14	86.0 3.39	1.5 0.06	125.0 4.92	– –	– –	106.4	21.0	0.0814	5.78 12.73
655	654D	3.5 0.14	88.0 3.46	1.5 0.06	141.0 5.55	– –	– –	136.6	27.3	0.0919	8.08 17.84
744A	742D	5.0 0.20	91.0 3.58	1.5 0.06	143.0 5.63	– –	– –	159.6	26.3	0.0898	9.32 20.54
745A	742D	3.5 0.14	88.0 3.46	1.5 0.06	143.0 5.63	– –	– –	159.6	26.3	0.0898	9.35 20.61
835	834D	3.5 0.14	91.0 3.58	0.8 0.03	155.0 6.10	– –	– –	197.9	34.8	0.0937	14.37 31.68
9382	9320D	3.5 0.14	101.0 3.98	2.3 0.09	164.0 6.46	– –	– –	117.9	18.6	0.1053	12.79 28.19

⁽⁴⁾These maximum fillet radii will be cleared by bearing corners.
NOTE: For spacer configuration information, contact your Timken engineer.

TAPERED ROLLER BEARINGS

DOUBLE-ROW • TYPE TDO

TYPE TDO



Bearing Dimensions				Load Ratings							
Bore d	O.D. D	Width T	Double Outer Ring Width C	Dynamic ⁽¹⁾				Dynamic ⁽³⁾			
				C ₁₍₂₎	e	Y ₁	Y ₂	C ₉₀	C _{a90}	C ₉₀₍₂₎	K
mm in.	mm in.	mm in.	mm in.	N lbf				N lbf	N lbf	N lbf	
69.952 2.7540	121.442 4.7812	52.390 2.0626	38.100 1.5000	178000 40000	0.45	1.50	2.23	26500 5960	20500 4600	46100 10400	1.30
70.000 2.7559	120.000 4.7244	65.090 2.5626	53.975 2.1250	250000 56100	0.38	1.75	2.61	37200 8360	24500 5500	64700 14600	1.52
70.637 2.7810	114.287 4.4995	58.738 2.3125	46.038 1.8125	192000 43300	0.49	1.38	2.06	28600 6440	23900 5370	49900 11200	1.20
71.437 2.8125	117.475 4.6250	66.675 2.6250	53.975 2.1250	241000 54200	0.44	1.55	2.31	35900 8060	26800 6020	62400 14000	1.34
71.437 2.8125	120.000 4.7244	71.438 2.8125	58.738 2.3125	311000 70000	0.36	1.87	2.79	46300 10400	28600 6420	80700 18100	1.62
71.437 2.8125	127.000 5.0000	80.962 3.1875	65.088 2.5625	342000 76900	0.36	1.86	2.76	50900 11400	31700 7130	88600 19900	1.61
71.437 2.8125	127.000 5.0000	80.962 3.1875	65.088 2.5625	342000 76900	0.36	1.86	2.76	50900 11400	31700 7130	88600 19900	1.61
71.437 2.8125	136.525 5.3750	69.850 2.7500	53.975 2.1250	269000 60500	0.44	1.52	2.26	40000 9000	30500 6850	69700 15700	1.31
71.437 2.8125	136.525 5.3750	95.250 3.7500	76.200 3.0000	481000 108000	0.36	1.86	2.78	71600 16100	44400 9980	125000 28000	1.61
71.437 2.8125	136.525 5.3750	95.250 3.7500	76.200 3.0000	481000 108000	0.36	1.86	2.78	71600 16100	44400 9980	125000 28000	1.61
73.025 2.8750	114.287 4.4995	58.738 2.3125	46.038 1.8125	192000 43300	0.49	1.38	2.06	28600 6440	23900 5370	49900 11200	1.20
73.025 2.8750	117.475 4.6250	66.675 2.6250	53.975 2.1250	241000 54200	0.44	1.55	2.31	35900 8060	26800 6020	62400 14000	1.34
73.025 2.8750	127.000 5.0000	80.962 3.1875	65.088 2.5625	342000 76900	0.36	1.86	2.76	50900 11400	31700 7130	88600 19900	1.61
73.025 2.8750	127.000 5.0000	80.962 3.1875	65.088 2.5625	342000 76900	0.36	1.86	2.76	50900 11400	31700 7130	88600 19900	1.61
73.025 2.8750	139.992 5.5115	82.550 3.2500	66.675 2.6250	360000 80900	0.40	1.67	2.49	53600 12100	37100 8330	93400 21000	1.45
73.025 2.8750	152.400 6.0000	95.250 3.7500	76.200 3.0000	430000 96700	0.41	1.65	2.46	64000 14400	44800 10100	112000 25100	1.43
73.025 2.8750	155.575 6.1250	101.600 4.0000	85.725 3.3750	656000 147000	0.33	2.08	3.09	97600 21900	54400 12200	170000 38200	1.80

⁽¹⁾Based on 1×10^6 revolutions L_{10} life, for the ISO life-calculation method. $C_{1(2)}$ is the double-row radial value.

⁽²⁾Consult your Timken engineer for instructions on use or review the Timken Engineering Manual on timken.com/catalogs.

⁽³⁾Based on 90×10^6 revolutions L_{10} life, for The Timken Company life-calculation method. C_{90} and C_{a90} are radial and thrust values for a single row. $C_{90(2)}$ is the double-row radial value.

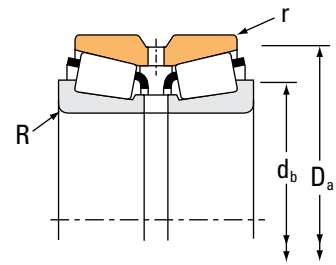
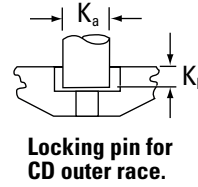
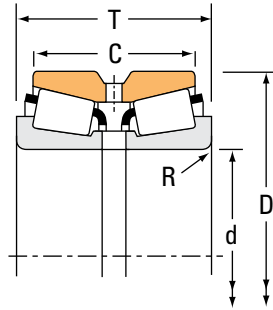
Part Number		Dimensions						Geometry Factors			Bearing Weight
Inner	Outer	Shaft		Housing		Pin		G ₁	G ₂	C _G	
		Max. Shaft Fillet Radius R ⁽⁴⁾	Backing Shoulder Dia. d _b	Max. Housing Fillet Radius r ⁽⁴⁾	Backing Shoulder Dia. D _a	K _a	K _b				
		mm in.	mm in.	mm in.	mm in.	mm in.	mm in.				kg lbs.
34274	34478D	2.0 0.08	81.0 3.19	0.8 0.03	116.0 4.57	– –	– –	69.3	27.0	0.1093	2.27 4.99
484	472D	2.0 0.08	80.0 3.15	0.8 0.03	114.0 4.49	– –	– –	77.2	23.0	0.1083	2.93 6.44
29680	29622D	1.3 0.05	80.0 3.15	0.8 0.03	109.0 4.29	– –	– –	77.7	43.3	0.1170	2.18 4.82
33281	33462D	3.5 0.14	87.0 3.43	0.8 0.03	112.0 4.41	– –	– –	84.2	25.9	0.1162	2.73 6.02
47490	47420D	3.5 0.14	86.0 3.39	0.8 0.03	114.0 4.49	– –	– –	98.4	26.3	0.1153	3.01 6.65
567A	563D	3.5 0.14	86.0 3.39	1.5 0.06	119.0 4.69	– –	– –	101.3	24.0	0.1167	4.02 8.86
567-S	563D	6.4 0.25	92.0 3.62	1.5 0.06	119.0 4.69	– –	– –	101.3	24.0	0.1167	3.96 8.75
495-S	493D	3.5 0.14	88.0 3.46	0.8 0.03	130.0 5.12	– –	– –	104.6	29.3	0.1252	4.41 9.70
644	632D	3.5 0.14	87.0 3.43	1.5 0.06	125.0 4.92	– –	– –	106.4	21.0	0.0814	5.70 12.56
645	632D	6.4 0.25	93.0 3.66	1.5 0.06	125.0 4.92	– –	– –	106.4	21.0	0.0814	5.64 12.40
29685	29622D	3.5 0.14	86.0 3.39	0.8 0.03	109.0 4.29	– –	– –	77.7	43.3	0.1170	2.06 4.53
33287	33462D	3.5 0.14	88.0 3.46	0.8 0.03	112.0 4.41	– –	– –	84.2	25.9	0.1162	2.64 5.81
567	563D	3.5 0.14	88.0 3.46	1.5 0.06	119.0 4.69	– –	– –	101.3	24.0	0.1167	3.90 8.59
567X	563D	4.8 0.19	90.0 3.54	1.5 0.06	119.0 4.69	– –	– –	101.3	24.0	0.1167	3.92 8.66
576	572D	3.5 0.14	90.0 3.54	0.8 0.03	133.0 5.24	– –	– –	125.7	32.0	0.1295	5.47 12.05
657	654D	3.5 0.14	91.0 3.58	1.5 0.06	141.0 5.55	– –	– –	136.6	27.3	0.0919	7.81 17.23
744	742D	3.5 0.14	91.0 3.58	1.5 0.06	143.0 5.63	– –	– –	159.6	26.3	0.0898	9.03 19.90

⁽⁴⁾These maximum fillet radii will be cleared by bearing corners.
NOTE: For spacer configuration information, contact your Timken engineer.

TAPERED ROLLER BEARINGS

DOUBLE-ROW • TYPE TDO

TYPE TDO



Bearing Dimensions				Load Ratings							
Bore d	O.D. D	Width T	Double Outer Ring Width C	Dynamic ⁽¹⁾		Factors ⁽²⁾		Dynamic ⁽³⁾			Factors ⁽²⁾
				C ₁₍₂₎	e	Y ₁	Y ₂	C ₉₀	C _{a90}	C ₉₀₍₂₎	K
mm in.	mm in.	mm in.	mm in.	N lbf				N lbf	N lbf	N lbf	
73.817 2.9062	114.287 4.4995	58.738 2.3125	46.038 1.8125	192000 43300	0.49	1.38	2.06	28600 6440	23900 5370	49900 11200	1.20
73.817 2.9062	127.000 5.0000	80.962 3.1875	65.088 2.5625	342000 76900	0.36	1.86	2.76	50900 11400	31700 7130	88600 19900	1.61
74.612 2.9375	139.992 5.5115	82.550 3.2500	66.675 2.6250	360000 80900	0.40	1.67	2.49	53600 12100	37100 8330	93400 21000	1.45
74.976 2.9518	121.442 4.7812	52.390 2.0626	38.100 1.5000	178000 40000	0.45	1.50	2.23	26500 5960	20500 4600	46100 10400	1.30
76.200 3.0000	109.538 4.3125	42.860 1.6874	34.925 1.3750	120000 27100	0.50	1.34	2.00	17900 4030	15400 3470	31200 7020	1.16
76.200 3.0000	121.442 4.7812	52.390 2.0626	38.100 1.5000	178000 40000	0.45	1.50	2.23	26500 5960	20500 4600	46100 10400	1.30
76.200 3.0000	121.442 4.7812	52.390 2.0626	38.100 1.5000	178000 40000	0.45	1.50	2.23	26500 5960	20500 4600	46100 10400	1.30
76.200 3.0000	136.525 5.3750	69.850 2.7500	53.975 2.1250	269000 60500	0.44	1.52	2.26	40000 9000	30500 6850	69700 15700	1.31
76.200 3.0000	139.992 5.5115	82.550 3.2500	66.675 2.6250	360000 80900	0.40	1.67	2.49	53600 12100	37100 8330	93400 21000	1.45
76.200 3.0000	152.400 6.0000	82.550 3.2500	63.500 2.5000	376000 84600	0.44	1.53	2.27	56000 12600	42400 9530	97500 21900	1.32
76.200 3.0000	152.400 6.0000	95.250 3.7500	76.200 3.0000	430000 96700	0.41	1.65	2.46	64000 14400	44800 10100	112000 25100	1.43
76.200 3.0000	155.575 6.1250	101.600 4.0000	85.725 3.3750	656000 147000	0.33	2.08	3.09	97600 21900	54400 12200	170000 38200	1.80
76.200 3.0000	161.925 6.3750	104.775 4.1250	85.725 3.3750	570000 128000	0.34	1.98	2.95	84800 19100	49500 11100	148000 33200	1.71
76.200 3.0000	161.925 6.3750	105.562 4.1560	70.637 2.7810	614000 138000	0.71	0.95	1.42	91400 20600	111000 24900	159000 35800	0.82
76.200 3.0000	171.450 6.7500	125.412 4.9375	100.012 3.9375	844000 190000	0.30	2.26	3.36	126000 28300	64400 14500	219000 49200	1.95
76.200 3.0000	171.450 6.7500	125.412 4.9375	100.012 3.9375	844000 190000	0.30	2.26	3.36	126000 28300	64400 14500	219000 49200	1.95
76.200 3.0000	177.800 7.0000	109.538 4.3125	74.612 2.9375	632000 142000	0.76	0.88	1.31	94100 21200	123000 27700	164000 36800	0.76

⁽¹⁾Based on 1 x 10⁶ revolutions L₁₀ life, for the ISO life-calculation method. C₁₍₂₎ is the double-row radial value.

⁽²⁾Consult your Timken engineer for instructions on use or review the Timken Engineering Manual on timken.com/catalogs.

⁽³⁾Based on 90 x 10⁶ revolutions L₁₀ life, for The Timken Company life-calculation method. C₉₀ and C_{a90} are radial and thrust values for a single row. C₉₀₍₂₎ is the double-row radial value.

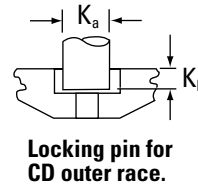
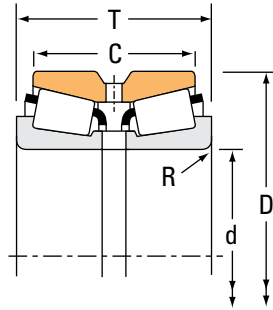
Part Number		Dimensions						Geometry Factors			Bearing Weight
Inner	Outer	Shaft		Housing		Pin		G ₁	G ₂	C _G	
		Max. Shaft Fillet Radius R ⁽⁴⁾	Backing Shoulder Dia. d _b	Max. Housing Fillet Radius r ⁽⁴⁾	Backing Shoulder Dia. D _a	K _a	K _b				
		mm in.	mm in.	mm in.	mm in.	mm in.	mm in.				kg lbs.
29688	29622D	1.5 0.06	83.0 3.27	0.8 0.03	109.0 4.29	– –	– –	77.7	43.3	0.1170	2.04 4.49
568	563D	0.8 0.03	83.0 3.27	1.5 0.06	119.0 4.69	– –	– –	101.3	24.0	0.1167	3.86 8.53
577	572D	3.5 0.14	91.0 3.58	0.8 0.03	133.0 5.24	– –	– –	125.7	32.0	0.1295	5.41 11.91
34294	34478D	2.0 0.08	85.0 3.35	0.8 0.03	116.0 4.57	– –	– –	69.3	27.0	0.1093	2.02 4.47
L814749	L814710D	1.5 0.06	84.0 3.31	0.8 0.03	105.0 4.13	– –	– –	76.0	58.3	0.1164	1.26 2.78
34300	34478D	2.0 0.08	86.0 3.39	0.8 0.03	116.0 4.57	– –	– –	69.3	27.0	0.1093	1.98 4.37
34301	34478D	3.5 0.14	89.0 3.50	0.8 0.03	116.0 4.57	– –	– –	69.3	27.0	0.1093	1.96 4.32
495A	493D	3.5 0.14	92.0 3.62	0.8 0.03	130.0 5.12	– –	– –	104.6	29.3	0.1252	4.04 8.90
575	572D	3.5 0.14	92.0 3.62	0.8 0.03	133.0 5.24	– –	– –	125.7	32.0	0.1295	5.23 11.53
590A	592D	3.5 0.14	95.0 3.74	0.8 0.03	144.0 5.67	– –	– –	151.4	38.3	0.1416	6.78 14.94
659	654D	3.5 0.14	93.0 3.66	1.5 0.06	141.0 5.55	– –	– –	136.6	27.3	0.0919	7.54 16.63
748-S	742D	3.5 0.14	93.0 3.66	1.5 0.06	143.0 5.63	– –	– –	159.6	26.3	0.0898	8.73 19.25
755	752D	3.5 0.14	98.0 3.86	1.5 0.06	150.0 5.91	– –	– –	177.2	29.4	0.0945	10.04 22.12
9285	9220D	3.5 0.14	111.0 4.37	0.8 0.03	153.0 6.03	– –	– –	102.5	16.1	0.0984	8.66 19.11
837	834D	0.8 0.03	90.0 3.54	0.8 0.03	155.0 6.10	– –	– –	197.9	34.8	0.0937	13.63 30.04
843	834D	6.4 0.25	101.0 3.98	0.8 0.03	155.0 6.10	– –	– –	197.9	34.8	0.0937	13.59 29.96
9380	9320D	3.5 0.14	105.0 4.13	2.3 0.09	164.0 6.46	– –	– –	117.9	18.6	0.1053	12.16 26.80

⁽⁴⁾These maximum fillet radii will be cleared by bearing corners.
NOTE: For spacer configuration information, contact your Timken engineer.

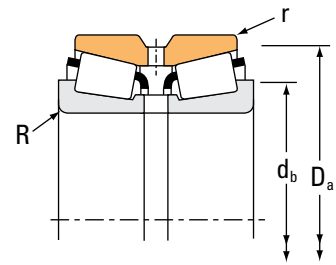
TAPERED ROLLER BEARINGS

DOUBLE-ROW • TYPE TDO

TYPE TDO



Locking pin for CD outer race.



Bearing Dimensions				Load Ratings							
Bore d	O.D. D	Width T	Double Outer Ring Width C	Dynamic ⁽¹⁾				Dynamic ⁽³⁾			
				C ₁₍₂₎	e	Y ₁	Y ₂	C ₉₀	C _{a90}	C ₉₀₍₂₎	K
mm in.	mm in.	mm in.	mm in.	N lbf				N lbf	N lbf	N lbf	
76.200 3.0000	177.800 7.0000	115.888 4.5625	74.612 2.9375	632000 142000	0.76	0.88	1.31	94100 21200	123000 27700	164000 36800	0.76
76.200 3.0000	190.500 7.5000	127.000 5.0000	104.775 4.1250	929000 209000	0.33	2.02	3.00	138000 31100	79300 17800	241000 54200	1.74
77.788 3.0625	121.442 4.7812	52.390 2.0626	38.100 1.5000	211000 47400	0.45	1.50	2.23	31400 7060	24200 5450	54700 12300	1.30
77.788 3.0625	136.525 5.3750	69.850 2.7500	53.975 2.1250	269000 60500	0.44	1.52	2.26	40000 9000	30500 6850	69700 15700	1.31
79.375 3.1250	152.400 6.0000	82.550 3.2500	63.500 2.5000	376000 84600	0.44	1.53	2.27	56000 12600	42400 9530	97500 21900	1.32
79.985 3.1490	139.992 5.5115	82.550 3.2500	66.675 2.6250	360000 80900	0.40	1.67	2.49	53600 12100	37100 8330	93400 21000	1.45
79.985 3.1490	152.400 6.0000	82.550 3.2500	63.500 2.5000	376000 84600	0.44	1.53	2.27	56000 12600	42400 9530	97500 21900	1.32
80.000 3.1496	155.575 6.1250	101.600 4.0000	85.725 3.3750	553000 124000	0.33	2.08	3.09	82400 18500	45900 10300	143000 32200	1.80
80.000 3.1496	200.025 7.8750	108.268 4.5625	80.216 3.1581	839000 189000	0.63	1.07	1.59	125000 28100	135000 30400	217000 48900	0.92
80.962 3.1875	136.525 5.3750	69.850 2.7500	53.975 2.1250	269000 60500	0.44	1.52	2.26	40000 9000	30500 6850	69700 15700	1.31
80.962 3.1875	139.992 5.5115	82.550 3.2500	66.675 2.6250	360000 80900	0.40	1.67	2.49	53600 12100	37100 8330	93400 21000	1.45
80.962 3.1875	152.400 6.0000	88.900 3.5000	76.200 3.0000	430000 96700	0.41	1.65	2.46	64000 14400	44800 10100	112000 25100	1.43
82.550 3.2500	115.888 4.5625	47.625 1.8750	39.690 1.5626	157000 35300	0.31	2.19	3.26	23400 5260	12300 2770	40700 9150	1.90
82.550 3.2500	136.525 5.3750	69.850 2.7500	53.975 2.1250	269000 60500	0.44	1.52	2.26	40000 9000	30500 6850	69700 15700	1.31
82.550 3.2500	139.992 5.5115	82.550 3.2500	66.675 2.6250	360000 80900	0.40	1.67	2.49	53600 12100	37100 8330	93400 21000	1.45
82.550 3.2500	139.992 5.5115	82.550 3.2500	66.675 2.6250	360000 80900	0.40	1.67	2.49	53600 12100	37100 8330	93400 21000	1.45
82.550 3.2500	152.400 6.0000	82.550 3.2500	63.500 2.5000	376000 84600	0.44	1.53	2.27	56000 12600	42400 9530	97500 21900	1.32

⁽¹⁾Based on 1 x 10⁶ revolutions L₁₀ life, for the ISO life-calculation method. C₁₍₂₎ is the double-row radial value.

⁽²⁾Consult your Timken engineer for instructions on use or review the Timken Engineering Manual on timken.com/catalogs.

⁽³⁾Based on 90 x 10⁶ revolutions L₁₀ life, for The Timken Company life-calculation method. C₉₀ and C_{a90} are radial and thrust values for a single row. C₉₀₍₂₎ is the double-row radial value.

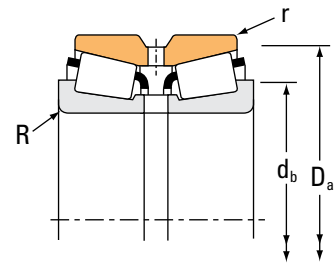
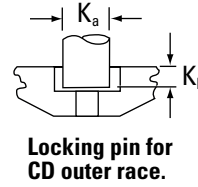
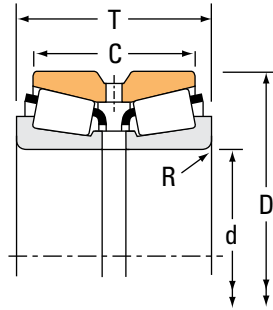
Part Number		Dimensions						Geometry Factors			Bearing Weight
Inner	Outer	Shaft		Housing		Pin		G ₁	G ₂	C _g	
		Max. Shaft Fillet Radius R ⁽⁴⁾	Backing Shoulder Dia. d _b	Max. Housing Fillet Radius r ⁽⁴⁾	Backing Shoulder Dia. D _a	K _a	K _b				
		mm in.	mm in.	mm in.	mm in.	mm in.	mm in.				kg lbs.
9378	9320D	3.5 0.14	105.0 4.13	2.3 0.09	164.0 6.46	– –	– –	117.9	18.6	0.1053	12.68 27.98
HH221430	HH221410D	3.5 0.14	101.0 3.98	1.5 0.06	179.0 7.05	– –	– –	265.6	28.4	0.1072	18.09 39.85
34306	34478D	3.5 0.14	91.0 3.58	0.8 0.03	116.0 4.57	– –	– –	69.3	27.0	0.1093	1.86 4.11
495AS	493D	3.5 0.14	93.0 3.66	0.8 0.03	130.0 5.12	– –	– –	104.6	29.3	0.1252	3.99 8.80
595A	592D	3.5 0.14	98.0 3.86	0.8 0.03	144.0 5.67	– –	– –	151.4	38.3	0.1416	6.51 14.35
578	572D	3.5 0.14	95.0 3.74	0.8 0.03	133.0 5.24	– –	– –	125.7	32.0	0.1295	3.52 7.76
590	592D	3.5 0.14	98.0 3.86	0.8 0.03	144.0 5.67	– –	– –	151.4	38.3	0.1416	4.48 9.87
748	742D	3.0 0.12	96.0 3.78	1.5 0.06	143.0 5.63	– –	– –	159.6	26.3	0.0898	8.38 18.45
98316	98789D	3.5 0.14	111.0 4.37	2.3 0.09	188.0 7.40	– –	– –	203.4	37.5	0.1197	17.28 38.11
496	493D	3.5 0.14	95.0 3.74	0.8 0.03	130.0 5.12	– –	– –	104.6	29.3	0.1252	3.74 8.23
581	572D	3.5 0.14	96.0 3.78	0.8 0.03	133.0 5.24	– –	– –	125.7	32.0	0.1295	4.88 10.75
662	654D	3.5 0.14	98.0 3.86	1.5 0.06	141.0 5.55	– –	– –	136.6	27.3	0.0919	6.77 14.96
L116149	L116110D	1.5 0.06	90.0 3.54	0.8 0.03	111.0 4.37	– –	– –	97.2	64.3	0.1079	0.98 2.17
495	493D	3.5 0.14	97.0 3.82	0.8 0.03	130.0 5.12	– –	– –	104.6	29.3	0.1252	3.63 8.00
580	572D	3.5 0.14	98.0 3.86	0.8 0.03	133.0 5.24	– –	– –	125.7	32.0	0.1295	4.74 10.47
582	572D	6.8 0.27	104.0 4.09	0.8 0.03	133.0 5.24	– –	– –	125.7	32.0	0.1295	4.69 10.33
595	592D	3.5 0.14	100.0 3.94	0.8 0.03	144.0 5.67	– –	– –	151.4	38.3	0.1416	6.26 13.80

⁽⁴⁾These maximum fillet radii will be cleared by bearing corners.
NOTE: For spacer configuration information, contact your Timken engineer.

TAPERED ROLLER BEARINGS

DOUBLE-ROW • TYPE TDO

TYPE TDO



Bearing Dimensions				Load Ratings							
Bore d	O.D. D	Width T	Double Outer Ring Width C	Dynamic ⁽¹⁾		Factors ⁽²⁾		Dynamic ⁽³⁾			Factors ⁽²⁾
				C ₁₍₂₎	e	Y ₁	Y ₂	C ₉₀	C _{a90}	C ₉₀₍₂₎	K
mm in.	mm in.	mm in.	mm in.	N lbf				N lbf	N lbf	N lbf	
82.550 3.2500	152.400 6.0000	95.250 3.7500	76.200 3.0000	430000 96700	0.41	1.65	2.46	64000 14400	44800 10100	112000 25100	1.43
82.550 3.2500	155.575 6.1250	101.600 4.0000	85.725 3.3750	656000 147000	0.33	2.08	3.09	97600 21900	54400 12200	170000 38200	1.80
82.550 3.2500	161.925 6.3750	104.775 4.1250	85.725 3.3750	570000 128000	0.34	1.98	2.95	84800 19100	49500 11100	148000 33200	1.71
82.550 3.2500	171.450 6.7500	125.412 4.9375	100.012 3.9375	844000 190000	0.30	2.26	3.36	126000 28300	64400 14500	219000 49200	1.95
84.138 3.3125	136.525 5.3750	69.850 2.7500	53.975 2.1250	269000 60500	0.44	1.52	2.26	40000 9000	30500 6850	69700 15700	1.31
84.138 3.3125	152.400 6.0000	95.250 3.7500	76.200 3.0000	430000 96700	0.41	1.65	2.46	64000 14400	44800 10100	112000 25100	1.43
84.138 3.3125	177.800 7.0000	109.538 4.3125	74.612 2.9375	632000 142000	0.76	0.88	1.31	94100 21200	123000 27700	164000 36800	0.76
85.000 3.3465	200.025 7.8750	108.268 4.5625	80.216 3.1581	839000 189000	0.63	1.07	1.59	125000 28100	135000 30400	217000 48900	0.92
85.025 3.3475	155.575 6.1250	101.600 4.0000	85.725 3.3750	656000 147000	0.33	2.08	3.09	97600 21900	54400 12200	170000 38200	1.80
85.725 3.3750	136.525 5.3750	69.850 2.7500	53.975 2.1250	269000 60500	0.44	1.52	2.26	40000 9000	30500 6850	69700 15700	1.31
85.725 3.3750	152.400 6.0000	82.550 3.2500	63.500 2.5000	376000 84600	0.44	1.53	2.27	56000 12600	42400 9530	97500 21900	1.32
85.725 3.3750	152.400 6.0000	95.250 3.7500	76.200 3.0000	430000 96700	0.41	1.65	2.46	64000 14400	44800 10100	112000 25100	1.43
85.725 3.3750	161.925 6.3750	104.775 4.1250	85.725 3.3750	570000 128000	0.34	1.98	2.95	84800 19100	49500 11100	148000 33200	1.71
85.725 3.3750	168.275 6.6250	92.075 3.6250	69.850 2.7500	461000 104000	0.47	1.43	2.14	68600 15400	55300 12400	119000 26900	1.24
85.725 3.3750	171.450 6.7500	125.412 4.9375	100.012 3.9375	844000 190000	0.30	2.26	3.36	126000 28300	64400 14500	219000 49200	1.95
87.312 3.4375	123.825 4.8750	50.797 1.9999	42.862 1.6875	161000 36300	0.33	2.05	3.05	24000 5400	13600 3050	41800 9400	1.77
87.312 3.4375	152.400 6.0000	82.550 3.2500	63.500 2.5000	376000 84600	0.44	1.53	2.27	56000 12600	42400 9530	97500 21900	1.32

⁽¹⁾Based on 1×10^6 revolutions L_{10} life, for the ISO life-calculation method. $C_{1(2)}$ is the double-row radial value.

⁽²⁾Consult your Timken engineer for instructions on use or review the Timken Engineering Manual on timken.com/catalogs.

⁽³⁾Based on 90×10^6 revolutions L_{10} life, for The Timken Company life-calculation method. C_{90} and C_{a90} are radial and thrust values for a single row. $C_{90(2)}$ is the double-row radial value.

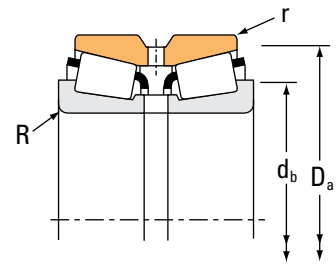
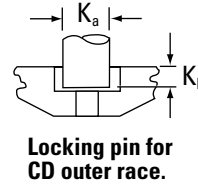
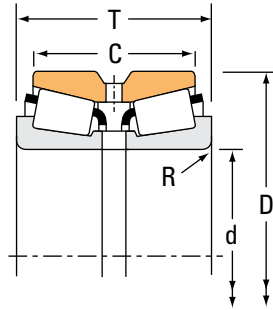
Part Number		Dimensions						Geometry Factors			Bearing Weight
Inner	Outer	Shaft		Housing		Pin		G ₁	G ₂	C _G	
		Max. Shaft Fillet Radius R ⁽⁴⁾	Backing Shoulder Dia. d _b	Max. Housing Fillet Radius r ⁽⁴⁾	Backing Shoulder Dia. D _a	K _a	K _b				
		mm in.	mm in.	mm in.	mm in.	mm in.	mm in.				kg lbs.
663	654D	3.5 0.14	99.0 3.90	1.5 0.06	141.0 5.55	– –	– –	136.6	27.3	0.0919	6.94 15.32
749A	742D	3.5 0.14	99.0 3.90	1.5 0.06	143.0 5.63	– –	– –	159.6	26.3	0.0898	8.10 17.88
757	752D	3.5 0.14	100.0 3.94	1.5 0.06	150.0 5.91	– –	– –	177.2	29.4	0.0945	9.43 20.80
842	834D	3.5 0.14	101.0 3.98	0.8 0.03	155.0 6.10	– –	– –	197.9	34.8	0.0937	13.02 28.73
498	493D	3.5 0.14	98.0 3.86	0.8 0.03	130.0 5.12	– –	– –	104.6	29.3	0.1252	3.53 7.79
664	654D	3.5 0.14	100.0 3.94	1.5 0.06	141.0 5.55	– –	– –	136.6	27.3	0.0919	6.82 15.02
9386H	9320D	3.5 0.14	111.0 4.37	2.3 0.09	164.0 6.46	– –	– –	117.9	18.6	0.1053	11.07 24.39
98335	98789D	3.5 0.14	115.0 4.53	2.3 0.09	188.0 7.40	– –	– –	203.4	37.5	0.1197	16.86 37.17
749	742D	3.5 0.14	101.0 3.98	1.5 0.06	143.0 5.63	– –	– –	159.6	26.3	0.0898	7.89 17.38
497	493D	3.5 0.14	99.0 3.90	0.8 0.03	130.0 5.12	– –	– –	104.6	29.3	0.1252	3.42 7.56
596	592D	3.5 0.14	102.0 4.02	0.8 0.03	144.0 5.67	– –	– –	151.4	38.3	0.1416	6.07 13.39
665	654D	3.5 0.14	102.0 4.02	1.5 0.06	141.0 5.55	– –	– –	136.6	27.3	0.0919	6.67 14.72
758	752D	3.5 0.14	106.0 4.17	1.5 0.06	150.0 5.91	– –	– –	177.2	29.4	0.0945	9.08 20.02
677	672D	3.5 0.14	105.0 4.13	0.8 0.03	160.0 6.30	– –	– –	182.5	37.3	0.1056	9.18 20.23
841	834D	3.5 0.14	104.0 4.09	0.8 0.03	155.0 6.10	– –	– –	197.9	34.8	0.0937	12.58 27.73
L217847	L217810D	1.5 0.06	96.0 3.78	0.8 0.03	119.0 4.69	– –	– –	111.3	74.8	0.1152	1.79 3.92
596-S	592D	3.5 0.14	103.0 4.06	0.8 0.03	144.0 5.67	– –	– –	151.4	38.3	0.1416	5.96 13.13

⁽⁴⁾These maximum fillet radii will be cleared by bearing corners.
NOTE: For spacer configuration information, contact your Timken engineer.

TAPERED ROLLER BEARINGS

DOUBLE-ROW • TYPE TDO

TYPE TDO



Bearing Dimensions				Load Ratings							
Bore d	O.D. D	Width T	Double Outer Ring Width C	Dynamic ⁽¹⁾				Dynamic ⁽³⁾			
				C ₁₍₂₎	e	Y ₁	Y ₂	C ₉₀	C _{a90}	C ₉₀₍₂₎	K
mm in.	mm in.	mm in.	mm in.	N lbf				N lbf	N lbf	N lbf	
87.312 3.4375	190.500 7.5000	127.000 5.0000	104.775 4.1250	929000 209000	0.33	2.02	3.00	138000 31100	79300 17800	241000 54200	1.74
87.960 3.4630	149.225 5.8750	66.672 2.6249	52.388 2.0625	336000 75600	0.49	1.37	2.04	50100 11300	42200 9480	87100 19600	1.19
88.900 3.5000	123.825 4.8750	50.797 1.9999	42.862 1.6875	161000 36300	0.33	2.05	3.05	24000 5400	13600 3050	41800 9400	1.77
88.900 3.5000	149.225 5.8750	66.672 2.6249	52.388 2.0625	336000 75600	0.49	1.37	2.04	50100 11300	42200 9480	87100 19600	1.19
88.900 3.5000	152.400 6.0000	82.550 3.2500	63.500 2.5000	376000 84600	0.44	1.53	2.27	56000 12600	42400 9530	97500 21900	1.32
88.900 3.5000	152.400 6.0000	82.550 3.2500	63.500 2.5000	376000 84600	0.44	1.53	2.27	56000 12600	42400 9530	97500 21900	1.32
88.900 3.5000	161.925 6.3750	104.775 4.1250	85.725 3.3750	570000 128000	0.34	1.98	2.95	84800 19100	49500 11100	148000 33200	1.71
88.900 3.5000	168.275 6.6250	92.075 3.6250	69.850 2.7500	461000 104000	0.47	1.43	2.14	68600 15400	55300 12400	119000 26900	1.24
88.900 3.5000	171.450 6.7500	125.412 4.9375	100.012 3.9375	844000 190000	0.30	2.26	3.36	126000 28300	64400 14500	219000 49200	1.95
88.900 3.5000	180.975 7.1250	104.774 4.1250	85.725 3.3750	603000 135000	0.39	1.75	2.61	89700 20200	59200 13300	156000 35100	1.51
88.900 3.5000	190.500 7.5000	127.000 5.0000	101.600 4.0000	797000 179000	0.33	2.02	3.00	119000 26700	68000 15300	207000 46400	1.74
88.900 3.5000	190.500 7.5000	127.000 5.0000	104.775 4.1250	929000 209000	0.33	2.02	3.00	138000 31100	79300 17800	241000 54200	1.74
88.900 3.5000	200.025 7.8750	115.888 4.5625	80.216 3.1581	839000 189000	0.63	1.07	1.59	125000 28100	135000 30400	217000 48900	0.92
89.891 3.5390	171.450 6.7500	125.412 4.9375	100.012 3.9375	712000 160000	0.30	2.26	3.36	106000 23800	54300 12200	185000 41500	1.95
89.916 3.5400	189.967 7.4790	85.852 3.3800	54.102 2.1300	499000 112000	0.87	0.78	1.16	74300 16700	110000 24800	129000 29100	0.67
89.980 3.5425	161.900 6.3740	69.850 2.7500	44.450 1.7500	354000 79500	0.73	0.92	1.37	52600 11800	65900 14800	91700 20600	0.80
90.488 3.5625	161.925 6.3750	104.775 4.1250	85.725 3.3750	570000 128000	0.34	1.98	2.95	84800 19100	49500 11100	148000 33200	1.71

⁽¹⁾Based on 1 x 10⁶ revolutions L₁₀ life, for the ISO life-calculation method. C₁₍₂₎ is the double-row radial value.

⁽²⁾Consult your Timken engineer for instructions on use or review the Timken Engineering Manual on timken.com/catalogs.

⁽³⁾Based on 90 x 10⁶ revolutions L₁₀ life, for The Timken Company life-calculation method. C₉₀ and C_{a90} are radial and thrust values for a single row. C₉₀₍₂₎ is the double-row radial value.

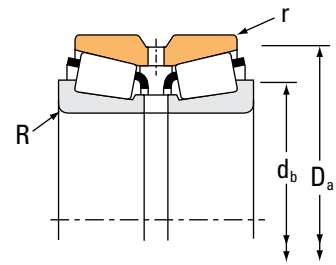
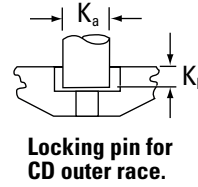
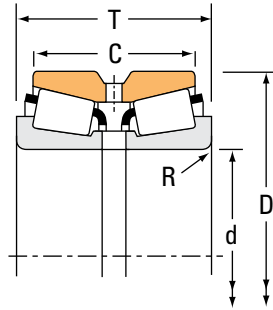
Part Number		Dimensions						Geometry Factors			Bearing Weight
Inner	Outer	Shaft		Housing		Pin		G ₁	G ₂	C _G	
		Max. Shaft Fillet Radius R ⁽⁴⁾	Backing Shoulder Dia. d _b	Max. Housing Fillet Radius r ⁽⁴⁾	Backing Shoulder Dia. D _a	K _a	K _b				
		mm in.	mm in.	mm in.	mm in.	mm in.	mm in.				kg lbs.
HH221432	HH221410D	8.0 0.31	118.0 4.65	1.5 0.06	179.0 7.05	– –	– –	265.6	28.4	0.1072	16.75 36.90
42346	42587D	3.0 0.12	103.0 4.06	0.8 0.03	143.0 5.63	– –	– –	129.7	37.2	0.1386	4.41 9.73
L217849	L217810D	1.5 0.06	97.0 3.82	0.8 0.03	119.0 4.69	– –	– –	111.3	74.8	0.1152	1.69 3.72
42350	42587D	3.0 0.12	104.0 4.09	0.8 0.03	143.0 5.63	– –	– –	129.7	37.2	0.1386	4.35 9.59
593	592D	3.5 0.14	104.0 4.09	0.8 0.03	144.0 5.67	– –	– –	151.4	38.3	0.1416	5.80 12.79
593A	592D	6.4 0.25	110.0 4.33	0.8 0.03	144.0 5.67	– –	– –	151.4	38.3	0.1416	5.76 12.67
759	752D	3.5 0.14	108.0 4.25	1.5 0.06	150.0 5.91	– –	– –	177.2	29.4	0.0945	8.71 19.18
679	672D	3.5 0.14	107.0 4.21	0.8 0.03	160.0 6.30	– –	– –	182.5	37.3	0.1056	8.82 19.44
850	834D	3.5 0.14	106.0 4.17	0.8 0.03	155.0 6.10	– –	– –	197.9	34.8	0.0937	12.15 26.78
775	774D	4.8 0.19	112.0 4.41	1.5 0.06	168.0 6.61	– –	– –	227.3	41.3	0.1067	12.02 26.52
855	854D	8.0 0.31	118.0 4.65	1.5 0.06	174.0 6.85	– –	– –	264.1	44.9	0.1072	16.69 36.77
HH221434	HH221410D	8.0 0.31	120.0 4.72	1.5 0.06	179.0 7.05	– –	– –	265.6	28.4	0.1072	16.53 36.42
98350	98789D	3.5 0.14	118.0 4.65	2.3 0.09	188.0 7.40	– –	– –	203.4	37.5	0.1197	16.38 36.08
850A	834D	3.5 0.14	107.0 4.21	0.8 0.03	155.0 6.10	– –	– –	197.9	34.8	0.0937	12.07 26.64
HM921343	HM921310D	3.5 0.14	117.0 4.61	1.5 0.06	181.0 7.13	– –	– –	137.2	32.0	0.1143	10.44 23.02
M919048	M919010D	3.5 0.14	109.0 4.29	1.5 0.06	154.0 6.06	– –	– –	102.3	30.7	0.0990	5.40 11.91
760	752D	3.5 0.14	110.0 4.33	1.5 0.06	150.0 5.91	– –	– –	177.2	29.4	0.0945	8.58 18.91

⁽⁴⁾These maximum fillet radii will be cleared by bearing corners.
NOTE: For spacer configuration information, contact your Timken engineer.

TAPERED ROLLER BEARINGS

DOUBLE-ROW • TYPE TDO

TYPE TDO



Bearing Dimensions				Load Ratings							
Bore d	O.D. D	Width T	Double Outer Ring Width C	Dynamic ⁽¹⁾		Factors ⁽²⁾		Dynamic ⁽³⁾			Factors ⁽²⁾
				C ₁₍₂₎	e	Y ₁	Y ₂	C ₉₀	C _{a90}	C ₉₀₍₂₎	K
mm in.	mm in.	mm in.	mm in.	N lbf				N lbf	N lbf	N lbf	
92.075 3.6250	149.225 5.8750	66.672 2.6249	52.388 2.0625	284000 63800	0.49	1.37	2.04	42200 9490	35600 8000	73500 16500	1.19
92.075 3.6250	152.400 6.0000	82.550 3.2500	63.500 2.5000	376000 84600	0.44	1.53	2.27	56000 12600	42400 9530	97500 21900	1.32
92.075 3.6250	152.400 6.0000	82.550 3.2500	63.500 2.5000	376000 84600	0.44	1.53	2.27	56000 12600	42400 9530	97500 21900	1.32
92.075 3.6250	168.275 6.6250	92.075 3.6250	69.850 2.7500	461000 104000	0.47	1.43	2.14	68600 15400	55300 12400	119000 26900	1.24
92.075 3.6250	180.975 7.1250	104.775 4.1250	85.725 3.3750	603000 135000	0.39	1.75	2.61	89700 20200	59200 13300	156000 35100	1.51
93.662 3.6875	149.225 5.8750	66.672 2.6249	52.388 2.0625	336000 75600	0.49	1.37	2.04	50100 11300	42200 9480	87100 19600	1.19
93.662 3.6875	152.400 6.0000	82.550 3.2500	63.500 2.5000	376000 84600	0.44	1.53	2.27	56000 12600	42400 9530	97500 21900	1.32
95.250 3.7500	130.175 5.1250	47.622 1.8749	39.688 1.5625	166000 37300	0.35	1.93	2.88	24700 5560	14800 3320	43100 9680	1.67
95.250 3.7500	136.525 5.3750	68.260 2.6874	57.150 2.2500	243000 54600	0.28	2.38	3.54	36200 8140	17600 3950	63000 14200	2.06
95.250 3.7500	149.225 5.8750	66.672 2.6249	52.388 2.0625	336000 75600	0.49	1.37	2.04	50100 11300	42200 9480	87100 19600	1.19
95.250 3.7500	149.225 5.8750	66.672 2.6249	52.388 2.0625	336000 75600	0.49	1.37	2.04	50100 11300	42200 9480	87100 19600	1.19
95.250 3.7500	152.400 6.0000	82.550 3.2500	63.500 2.5000	376000 84600	0.44	1.53	2.27	56000 12600	42400 9530	97500 21900	1.32
95.250 3.7500	152.400 6.0000	82.550 3.2500	63.500 2.5000	376000 84600	0.44	1.53	2.27	56000 12600	42400 9530	97500 21900	1.32
95.250 3.7500	161.925 6.3750	82.547 3.2499	61.912 2.4375	389000 87500	0.47	1.42	2.12	57900 13000	47100 10600	101000 22700	1.23
95.250 3.7500	168.275 6.6250	92.075 3.6250	69.850 2.7500	461000 104000	0.47	1.43	2.14	68600 15400	55300 12400	119000 26900	1.24
95.250 3.7500	180.975 7.1250	104.775 4.1250	85.725 3.3750	603000 135000	0.39	1.75	2.61	89700 20200	59200 13300	156000 35100	1.51
95.250 3.7500	190.500 7.5000	127.000 5.0000	104.775 4.1250	929000 209000	0.33	2.02	3.00	138000 31100	79300 17800	241000 54200	1.74

⁽¹⁾Based on 1×10^6 revolutions L_{10} life, for the ISO life-calculation method. $C_{1(2)}$ is the double-row radial value.

⁽²⁾Consult your Timken engineer for instructions on use or review the Timken Engineering Manual on timken.com/catalogs.

⁽³⁾Based on 90×10^6 revolutions L_{10} life, for The Timken Company life-calculation method. C_{90} and C_{a90} are radial and thrust values for a single row. $C_{90(2)}$ is the double-row radial value.

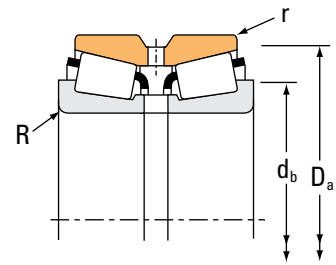
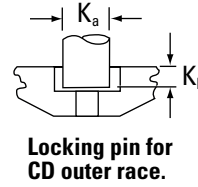
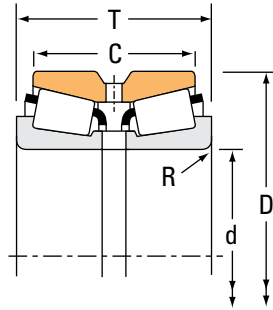
Part Number		Dimensions						Geometry Factors			Bearing Weight
Inner	Outer	Shaft		Housing		Pin		G ₁	G ₂	C _G	
		Max. Shaft Fillet Radius R ⁽⁴⁾	Backing Shoulder Dia. d _b	Max. Housing Fillet Radius r ⁽⁴⁾	Backing Shoulder Dia. D _a	K _a	K _b				
		mm in.	mm in.	mm in.	mm in.	mm in.	mm in.				kg lbs.
42362	42587D	3.5 0.14	107.0 4.21	0.8 0.03	143.0 5.63	– –	– –	129.7	37.2	0.1386	4.08 8.97
598	592D	3.5 0.14	107.0 4.21	0.8 0.03	144.0 5.67	– –	– –	151.4	38.3	0.1416	5.50 12.11
598X	592D	3.5 0.14	107.0 4.21	0.8 0.03	144.0 5.67	– –	– –	151.4	38.3	0.1416	5.52 12.15
681	672D	3.5 0.14	110.0 4.33	0.8 0.03	160.0 6.30	– –	– –	182.5	37.3	0.1056	8.52 18.80
778	774D	3.5 0.14	111.0 4.37	1.5 0.06	168.0 6.61	– –	– –	227.3	41.3	0.1067	11.73 25.84
42368	42587D	3.0 0.12	107.0 4.21	0.8 0.03	143.0 5.63	– –	– –	129.7	37.2	0.1386	4.03 8.86
597	592D	3.5 0.14	109.0 4.29	0.8 0.03	144.0 5.67	– –	– –	151.4	38.3	0.1416	5.37 11.86
L319249	L319210D	1.5 0.06	103.0 4.06	0.8 0.03	125.0 4.92	– –	– –	125.3	90.8	0.1220	1.73 3.83
LM119348	LM119311D	2.3 0.09	105.0 4.13	0.8 0.03	131.0 5.16	– –	– –	149.4	84.1	0.1213	2.95 6.52
42375	42587D	3.0 0.12	108.0 4.25	0.8 0.03	143.0 5.63	– –	– –	129.7	37.2	0.1386	3.90 8.59
42376	42587D	3.5 0.14	109.0 4.29	0.8 0.03	143.0 5.63	– –	– –	129.7	37.2	0.1386	3.90 8.57
594	592D	3.5 0.14	110.0 4.33	0.8 0.03	144.0 5.67	– –	– –	151.4	38.3	0.1416	5.22 11.49
594A	592D	5.0 0.20	113.0 4.45	0.8 0.03	144.0 5.67	– –	– –	151.4	38.3	0.1416	5.20 11.46
52375	52637D	3.5 0.14	112.0 4.41	0.8 0.03	154.0 6.06	– –	– –	175.4	41.7	0.1519	6.49 14.33
683	672D	3.5 0.14	113.0 4.45	0.8 0.03	160.0 6.30	– –	– –	182.5	37.3	0.1056	8.17 18.02
776	774D	3.5 0.14	114.0 4.49	1.5 0.06	168.0 6.61	– –	– –	227.3	41.3	0.1067	11.56 25.47
HH221440	HH221410D	8.0 0.31	125.0 4.92	1.5 0.06	179.0 7.05	– –	– –	265.6	28.4	0.1072	15.61 34.39

⁽⁴⁾These maximum fillet radii will be cleared by bearing corners.
NOTE: For spacer configuration information, contact your Timken engineer.

TAPERED ROLLER BEARINGS

DOUBLE-ROW • TYPE TDO

TYPE TDO



Bearing Dimensions				Load Ratings							
Bore d	O.D. D	Width T	Double Outer Ring Width C	Dynamic ⁽¹⁾				Dynamic ⁽³⁾			
				C ₁₍₂₎	e	Y ₁	Y ₂	C ₉₀	C _{a90}	C ₉₀₍₂₎	K
mm in.	mm in.	mm in.	mm in.	N lbf				N lbf	N lbf	N lbf	
96.838 3.8125	149.225 5.8750	66.672 2.6249	52.388 2.0625	336000 75600	0.49	1.37	2.04	50100 11300	42200 9480	87100 19600	1.19
98.425 3.8750	161.925 6.3750	82.547 3.2499	61.912 2.4375	389000 87500	0.47	1.42	2.12	57900 13000	47100 10600	101000 22700	1.23
98.425 3.8750	168.275 6.6250	92.075 3.6250	69.850 2.7500	461000 104000	0.47	1.43	2.14	68600 15400	55300 12400	119000 26900	1.24
98.425 3.8750	180.000 7.0866	104.775 4.1250	85.725 3.3750	603000 135000	0.39	1.75	2.61	89700 20200	59200 13300	156000 35100	1.51
98.425 3.8750	180.975 7.1250	104.775 4.1250	85.725 3.3750	603000 135000	0.39	1.75	2.61	89700 20200	59200 13300	156000 35100	1.51
98.425 3.8750	190.500 7.5000	127.000 5.0000	101.600 4.0000	797000 179000	0.33	2.02	3.00	119000 26700	68000 15300	207000 46400	1.74
98.425 3.8750	190.500 7.5000	127.000 5.0000	104.775 4.1250	929000 209000	0.33	2.02	3.00	138000 31100	79300 17800	241000 54200	1.74
98.425 3.8750	212.725 8.3750	142.875 5.6250	117.475 4.6250	996000 224000	0.33	2.07	3.09	148000 33300	82700 18600	258000 58000	1.79
98.425 3.8750	212.725 8.3750	142.875 5.6250	117.475 4.6250	1180000 266000	0.33	2.07	3.09	176000 39600	98300 22100	307000 69000	1.79
99.975 3.9360	212.725 8.3750	142.875 5.6250	117.475 4.6250	1180000 266000	0.33	2.07	3.09	176000 39600	98300 22100	307000 69000	1.79
99.979 3.9362	196.850 7.7500	103.378 4.0700	74.422 2.9300	656000 148000	0.61	1.11	1.66	97700 22000	101000 22800	170000 38300	0.96
99.982 3.9363	190.500 7.5000	127.000 5.0000	104.775 4.1250	929000 209000	0.33	2.02	3.00	138000 31100	79300 17800	241000 54200	1.74
100.000 3.9370	180.000 7.0866	104.775 4.1250	85.725 3.3750	603000 135000	0.39	1.75	2.61	89700 20200	59200 13300	156000 35100	1.51
100.000 3.9370	180.975 7.1250	104.775 4.1250	85.725 3.3750	603000 135000	0.39	1.75	2.61	89700 20200	59200 13300	156000 35100	1.51
100.000 3.9370	200.025 7.8750	115.888 4.5625	80.216 3.1581	839000 189000	0.63	1.07	1.59	125000 28100	135000 30400	217000 48900	0.92
100.012 3.9375	161.925 6.3750	82.547 3.2499	61.912 2.4375	389000 87500	0.47	1.42	2.12	57900 13000	47100 10600	101000 22700	1.23
101.600 4.0000	146.050 5.7500	49.212 1.9375	39.688 1.5625	167000 37600	0.39	1.72	2.56	24900 5600	16700 3760	43300 9740	1.49

⁽¹⁾Based on 1×10^6 revolutions L_{10} life, for the ISO life-calculation method. $C_{1(2)}$ is the double-row radial value.

⁽²⁾Consult your Timken engineer for instructions on use or review the Timken Engineering Manual on timken.com/catalogs.

⁽³⁾Based on 90×10^6 revolutions L_{10} life, for The Timken Company life-calculation method. C_{90} and C_{a90} are radial and thrust values for a single row. $C_{90(2)}$ is the double-row radial value.

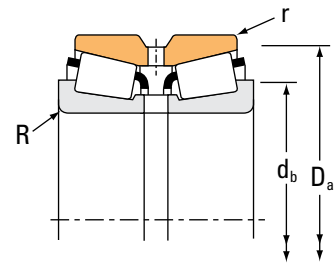
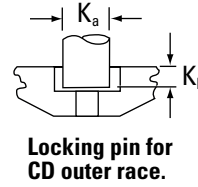
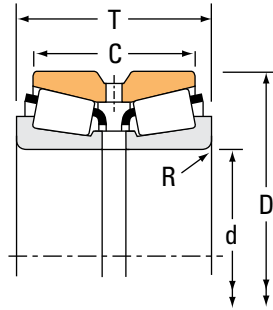
Part Number		Dimensions						Geometry Factors			Bearing Weight
Inner	Outer	Shaft		Housing		Pin		G ₁	G ₂	C _G	
		Max. Shaft Fillet Radius R ⁽⁴⁾	Backing Shoulder Dia. d _b	Max. Housing Fillet Radius r ⁽⁴⁾	Backing Shoulder Dia. D _a	K _a	K _b				
		mm in.	mm in.	mm in.	mm in.	mm in.	mm in.				kg lbs.
42381	42587D	3.5 0.14	112.0 4.41	0.8 0.03	143.0 5.63	– –	– –	129.7	37.2	0.1386	3.78 8.33
52387	52637D	3.5 0.14	114.0 4.49	0.8 0.03	154.0 6.06	– –	– –	175.4	41.7	0.1519	6.16 13.58
685	672D	3.5 0.14	116.0 4.57	0.8 0.03	160.0 6.30	– –	– –	182.5	37.3	0.1056	7.85 17.29
779	773D	3.5 0.14	116.0 4.57	0.8 0.03	168.0 6.61	– –	– –	227.3	41.3	0.1067	10.97 24.18
779	774D	3.5 0.14	116.0 4.57	1.5 0.06	168.0 6.61	– –	– –	227.3	41.3	0.1067	10.98 24.20
866	854D	3.5 0.14	118.0 4.65	1.5 0.06	174.0 6.85	– –	– –	264.1	44.9	0.1072	15.41 33.97
HH221442	HH221410D	3.5 0.14	119.0 4.69	1.5 0.06	179.0 7.05	– –	– –	265.6	28.4	0.1072	15.24 33.61
943	932CD	3.5 0.14	120.0 4.72	1.5 0.06	193.1 7.60	22.23 0.88	8.73 0.34	338.6	39.8	0.1153	23.16 51.08
HH224332	HH224310CD	3.5 0.14	123.0 4.84	1.5 0.06	201.7 7.94	25.40 1.00	7.95 0.31	366.6	47.9	0.1182	23.40 51.56
HH224334	HH224310CD	3.5 0.14	124.0 4.88	1.5 0.06	201.7 7.94	25.40 1.00	7.95 0.31	366.6	47.9	0.1182	23.21 51.17
HM821547	HM821511D	3.5 0.14	123.0 4.84	1.5 0.06	187.0 7.36	– –	– –	166.2	24.2	0.1100	12.42 27.39
HH221447	HH221410D	6.4 0.25	126.0 4.96	1.5 0.06	179.0 7.05	– –	– –	265.6	28.4	0.1072	14.89 32.80
783	773D	3.5 0.14	118.0 4.65	0.8 0.03	168.0 6.61	– –	– –	227.3	41.3	0.1067	10.83 23.87
783	774D	3.5 0.14	118.0 4.65	1.5 0.06	168.0 6.61	– –	– –	227.3	41.3	0.1067	10.78 23.74
98394X	98789D	3.5 0.14	126.0 4.96	2.3 0.09	188.0 7.40	– –	– –	203.4	37.5	0.1197	14.94 32.93
52393	52637D	3.5 0.14	116.0 4.57	0.8 0.03	154.0 6.06	– –	– –	175.4	41.7	0.1519	6.38 14.09
L521945	L521910D	1.5 0.06	112.0 4.41	0.8 0.03	141.0 5.55	– –	– –	152.1	107.9	0.1346	2.51 5.55

⁽⁴⁾These maximum fillet radii will be cleared by bearing corners.
NOTE: For spacer configuration information, contact your Timken engineer.

TAPERED ROLLER BEARINGS

DOUBLE-ROW • TYPE TDO

TYPE TDO



Bearing Dimensions				Load Ratings							
Bore d	O.D. D	Width T	Double Outer Ring Width C	Dynamic ⁽¹⁾				Dynamic ⁽³⁾			
				C ₁₍₂₎	e	Y ₁	Y ₂	C ₉₀	C _{a90}	C ₉₀₍₂₎	K
mm in.	mm in.	mm in.	mm in.	N lbf				N lbf	N lbf	N lbf	
101.600 4.0000	146.050 5.7500	49.212 1.9375	38.895 1.5313	223000 50100	0.39	1.74	2.59	33200 7460	22000 4950	57800 13000	1.51
101.600 4.0000	161.925 6.3750	82.547 3.2499	61.912 2.4375	389000 87500	0.47	1.42	2.12	57900 13000	47100 10600	101000 22700	1.23
101.600 4.0000	161.925 6.3750	82.547 3.2499	61.912 2.4375	389000 87500	0.47	1.42	2.12	57900 13000	47100 10600	101000 22700	1.23
101.600 4.0000	165.100 6.5000	106.350 4.1870	114.300 4.5000	470000 106000	0.26	2.55	3.80	70000 15700	31700 7130	122000 27400	2.21
101.600 4.0000	168.275 6.6250	92.075 3.6250	69.850 2.7500	461000 104000	0.47	1.43	2.14	68600 15400	55300 12400	119000 26900	1.24
101.600 4.0000	180.000 7.0866	104.775 4.1250	85.725 3.3750	603000 135000	0.39	1.75	2.61	89700 20200	59200 13300	156000 35100	1.51
101.600 4.0000	180.975 7.1250	104.775 4.1250	85.725 3.3750	603000 135000	0.39	1.75	2.61	89700 20200	59200 13300	156000 35100	1.51
101.600 4.0000	180.975 7.1250	104.775 4.1250	85.725 3.3750	603000 135000	0.39	1.75	2.61	89700 20200	59200 13300	156000 35100	1.51
101.600 4.0000	190.500 7.5000	127.000 5.0000	101.600 4.0000	797000 179000	0.33	2.02	3.00	119000 26700	68000 15300	207000 46400	1.74
101.600 4.0000	190.500 7.5000	127.000 5.0000	104.775 4.1250	929000 209000	0.33	2.02	3.00	138000 31100	79300 17800	241000 54200	1.74
101.600 4.0000	200.025 7.8750	115.888 4.5625	80.216 3.1581	839000 189000	0.63	1.07	1.59	125000 28100	135000 30400	217000 48900	0.92
101.600 4.0000	212.725 8.3750	142.875 5.6250	117.475 4.6250	996000 224000	0.33	2.07	3.09	148000 33300	82700 18600	258000 58000	1.79
101.600 4.0000	212.725 8.3750	142.875 5.6250	117.475 4.6250	1180000 266000	0.33	2.07	3.09	176000 39600	98300 22100	307000 69000	1.79
101.600 4.0000	214.312 8.4375	115.888 4.5625	84.138 3.3125	970000 218000	0.67	1.00	1.49	144000 32500	167000 37500	251000 56500	0.87
104.775 4.1250	180.000 7.0866	104.775 4.1250	85.725 3.3750	603000 135000	0.39	1.75	2.61	89700 20200	59200 13300	156000 35100	1.51
104.775 4.1250	180.000 7.0866	104.775 4.1250	85.725 3.3750	603000 135000	0.39	1.75	2.61	89700 20200	59200 13300	156000 35100	1.51
104.775 4.1250	180.000 7.0866	104.775 4.1250	85.725 3.3750	603000 135000	0.39	1.75	2.61	89700 20200	59200 13300	156000 35100	1.51

⁽¹⁾Based on 1 x 10⁶ revolutions L₁₀ life, for the ISO life-calculation method. C₁₍₂₎ is the double-row radial value.

⁽²⁾Consult your Timken engineer for instructions on use or review the Timken Engineering Manual on timken.com/catalogs.

⁽³⁾Based on 90 x 10⁶ revolutions L₁₀ life, for The Timken Company life-calculation method. C₉₀ and C_{a90} are radial and thrust values for a single row. C₉₀₍₂₎ is the double-row radial value.

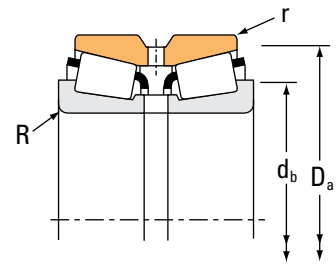
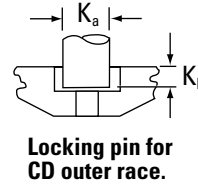
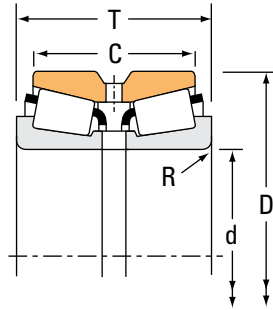
Part Number		Dimensions						Geometry Factors			Bearing Weight
Inner	Outer	Shaft		Housing		Pin		G ₁	G ₂	C _G	
		Max. Shaft Fillet Radius R ⁽⁴⁾	Backing Shoulder Dia. d _b	Max. Housing Fillet Radius r ⁽⁴⁾	Backing Shoulder Dia. D _a	K _a	K _b				
		mm in.	mm in.	mm in.	mm in.	mm in.	mm in.				kg lbs.
LM520349	LM520310D	1.5 0.06	110.0 4.33	0.8 0.03	140.0 5.51	– –	– –	120.9	58.5	0.1249	2.44 5.37
52400	52637D	3.5 0.14	117.0 4.61	0.8 0.03	154.0 6.06	– –	– –	175.4	41.7	0.1519	5.85 12.89
52401	52637D	8.0 0.31	128.0 5.04	0.8 0.03	154.0 6.06	– –	– –	175.4	41.7	0.1519	5.82 12.83
HM120848	HM120817XD	1.5 0.06	112.0 4.41	1.0 0.04	154.7 6.09	– –	– –	226.8	59.7	0.0941	8.87 19.53
687	672D	3.5 0.14	118.0 4.65	0.8 0.03	160.0 6.30	– –	– –	182.5	37.3	0.1056	7.47 16.49
780	773D	3.5 0.14	119.0 4.69	0.8 0.03	168.0 6.61	– –	– –	227.3	41.3	0.1067	10.58 23.33
780	774D	3.5 0.14	119.0 4.69	1.5 0.06	168.0 6.61	– –	– –	227.3	41.3	0.1067	10.63 23.42
780	774CD	3.5 0.14	119.0 4.69	1.5 0.06	168.0 6.61	19.05 0.75	7.13 0.28	227.3	41.3	0.1067	10.63 23.42
861	854D	8.0 0.31	129.0 5.08	1.5 0.06	174.0 6.85	– –	– –	264.1	44.9	0.1072	14.85 32.71
HH221449	HH221410D	8.0 0.31	131.0 5.16	1.5 0.06	179.0 7.05	– –	– –	265.6	28.4	0.1072	14.69 32.40
98400	98789D	3.5 0.14	128.0 5.04	2.3 0.09	188.0 7.40	– –	– –	203.4	37.5	0.1197	14.59 32.17
941	932CD	7.0 0.28	130.0 5.12	1.5 0.06	193.1 7.60	22.23 0.88	8.73 0.34	338.6	39.8	0.1153	22.56 49.74
HH224335	HH224310CD	7.0 0.28	132.0 5.20	1.5 0.06	201.7 7.94	25.40 1.00	7.95 0.31	366.6	47.9	0.1182	22.87 50.44
H924033	H924010D	3.5 0.14	132.0 5.20	1.5 0.06	205.0 8.07	– –	– –	245.6	32.2	0.1299	18.56 40.91
782	773D	3.5 0.14	122.0 4.80	0.8 0.03	168.0 6.61	– –	– –	227.3	41.3	0.1067	10.25 22.60
786	773D	6.4 0.25	128.0 5.04	0.8 0.03	168.0 6.61	– –	– –	227.3	41.3	0.1067	10.14 22.35
787	773D	7.0 0.28	129.0 5.08	0.8 0.03	168.0 6.61	– –	– –	227.3	41.3	0.1067	10.13 22.37

⁽⁴⁾These maximum fillet radii will be cleared by bearing corners.
NOTE: For spacer configuration information, contact your Timken engineer.

TAPERED ROLLER BEARINGS

DOUBLE-ROW • TYPE TDO

TYPE TDO



Bearing Dimensions				Load Ratings							
Bore d	O.D. D	Width T	Double Outer Ring Width C	Dynamic ⁽¹⁾				Dynamic ⁽³⁾			
				C ₁₍₂₎	e	Y ₁	Y ₂	C ₉₀	C _{a90}	C ₉₀₍₂₎	K
mm in.	mm in.	mm in.	mm in.	N lbf				N lbf	N lbf	N lbf	
104.775 4.1250	180.975 7.1250	104.775 4.1250	85.725 3.3750	603000 135000	0.39	1.75	2.61	89700 20200	59200 13300	156000 35100	1.51
104.775 4.1250	190.500 7.5000	106.362 4.1875	80.962 3.1875	633000 142000	0.42	1.62	2.42	94300 21200	67100 15100	164000 36900	1.40
106.362 4.1875	165.100 6.5000	82.550 3.2500	63.500 2.5000	394000 88600	0.50	1.36	2.02	58700 13200	50000 11200	102000 23000	1.18
106.362 4.1875	165.100 6.5000	82.550 3.2500	63.500 2.5000	394000 88600	0.50	1.36	2.02	58700 13200	50000 11200	102000 23000	1.18
107.950 4.2500	146.050 5.7500	49.212 1.9375	39.688 1.5625	155000 34800	0.39	1.72	2.56	23100 5180	15500 3480	40100 9020	1.49
107.950 4.2500	158.750 6.2500	53.978 2.1251	39.688 1.5625	238000 53400	0.61	1.11	1.66	35400 7960	36700 8250	61600 13900	0.96
107.950 4.2500	159.987 6.2987	74.612 2.9375	58.738 2.3125	404000 90800	0.40	1.68	2.50	60100 13500	41400 9300	105000 23500	1.45
107.950 4.2500	165.100 6.5000	82.550 3.2500	63.500 2.5000	394000 88600	0.50	1.36	2.02	58700 13200	50000 11200	102000 23000	1.18
107.950 4.2500	165.100 6.5000	82.550 3.2500	63.500 2.5000	394000 88600	0.50	1.36	2.02	58700 13200	50000 11200	102000 23000	1.18
107.950 4.2500	190.500 7.5000	106.362 4.1875	80.962 3.1875	633000 142000	0.42	1.62	2.42	94300 21200	67100 15100	164000 36900	1.40
107.950 4.2500	212.725 8.3750	142.875 5.6250	117.475 4.6250	996000 224000	0.33	2.07	3.09	148000 33300	82700 18600	258000 58000	1.79
107.950 4.2500	212.725 8.3750	142.875 5.6250	117.475 4.6250	1180000 266000	0.33	2.07	3.09	176000 39600	98300 22100	307000 69000	1.79
109.538 4.3125	158.750 6.2500	53.978 2.1251	39.688 1.5625	201000 45100	0.61	1.11	1.66	29900 6710	31000 6960	52000 11700	0.96
109.952 4.3288	190.500 7.5000	106.362 4.1875	80.962 3.1875	633000 142000	0.42	1.62	2.42	94300 21200	67100 15100	164000 36900	1.40
109.987 4.3302	159.987 6.2987	74.612 2.9375	58.738 2.3125	341000 76600	0.40	1.68	2.50	50700 11400	34900 7850	88400 19900	1.45
109.987 4.3302	159.987 6.2987	74.612 2.9375	58.738 2.3125	404000 90800	0.40	1.68	2.50	60100 13500	41400 9300	105000 23500	1.45
109.992 4.3304	177.800 7.0000	92.075 3.6250	69.850 2.7500	478000 108000	0.52	1.31	1.95	71200 16000	62900 14100	124000 27900	1.13

⁽¹⁾Based on 1 x 10⁶ revolutions L₁₀ life, for the ISO life-calculation method. C₁₍₂₎ is the double-row radial value.

⁽²⁾Consult your Timken engineer for instructions on use or review the Timken Engineering Manual on timken.com/catalogs.

⁽³⁾Based on 90 x 10⁶ revolutions L₁₀ life, for The Timken Company life-calculation method. C₉₀ and C_{a90} are radial and thrust values for a single row. C₉₀₍₂₎ is the double-row radial value.

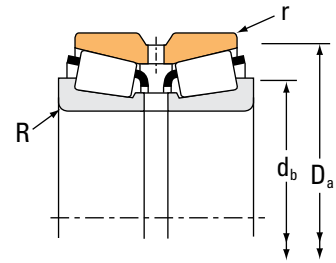
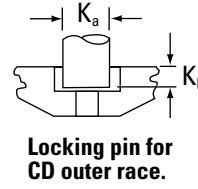
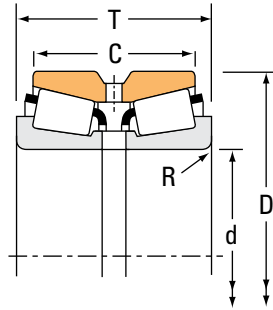
Part Number		Dimensions						Geometry Factors			Bearing Weight
Inner	Outer	Shaft		Housing		Pin		G ₁	G ₂	C _g	
		Max. Shaft Fillet Radius R ⁽⁴⁾	Backing Shoulder Dia. d _b	Max. Housing Fillet Radius r ⁽⁴⁾	Backing Shoulder Dia. D _a	K _a	K _b				
		mm in.	mm in.	mm in.	mm in.	mm in.	mm in.				kg lbs.
782	774D	3.5 0.14	122.0 4.80	1.5 0.06	168.0 6.61	– –	– –	227.3	41.3	0.1067	10.20 22.47
71412	71751D	3.5 0.14	124.0 4.88	1.5 0.06	181.0 7.13	– –	– –	269.2	49.5	0.1156	12.34 27.21
56418	56650CD	3.5 0.14	122.0 4.80	0.8 0.03	159.0 6.26	14.29 0.56	5.56 0.22	190.9	47.7	0.1584	5.97 13.15
56418	56650D	3.5 0.14	122.0 4.80	0.8 0.03	159.0 6.26	– –	– –	190.9	47.7	0.1584	5.95 13.12
L521949	L521910D	1.5 0.06	116.0 4.57	0.8 0.03	141.0 5.55	– –	– –	152.1	107.9	0.1346	2.18 4.80
37425	37626D	3.5 0.14	122.0 4.80	0.8 0.03	152.0 5.98	– –	– –	123.7	57.1	0.1443	3.21 7.07
LM522546	LM522510D	3.5 0.14	122.0 4.80	0.8 0.03	154.0 6.06	– –	– –	231.6	63.4	0.1576	5.05 11.11
56425	56650D	3.5 0.14	123.0 4.84	0.8 0.03	159.0 6.26	– –	– –	190.9	47.7	0.1584	6.37 14.05
56425	56650CD	3.5 0.14	123.0 4.84	0.8 0.03	159.0 6.26	14.29 0.56	5.56 0.22	190.9	47.7	0.1584	6.37 14.05
71425	71751D	3.6 0.14	126.0 4.96	1.5 0.06	181.0 7.13	– –	– –	269.2	49.5	0.1156	11.89 26.24
936	932CD	8.0 0.31	137.0 5.39	1.5 0.06	193.1 7.60	22.23 0.88	8.73 0.34	338.6	39.8	0.1153	21.52 47.42
HH224340	HH224310CD	8.0 0.31	139.0 5.47	1.5 0.06	201.7 7.94	25.40 1.00	7.95 0.31	366.6	47.9	0.1182	21.63 47.68
37431	37626D	3.5 0.14	123.0 4.84	0.8 0.03	152.0 5.98	– –	– –	123.7	57.1	0.1443	3.15 6.94
71432	71751D	3.5 0.14	128.0 5.04	1.5 0.06	181.0 7.13	– –	– –	269.2	49.5	0.1156	12.02 26.52
LM522548	LM522510D	8.0 0.31	133.0 5.24	0.8 0.03	154.0 6.06	– –	– –	231.6	63.4	0.1576	4.71 10.37
LM522549	LM522510D	3.5 0.14	124.0 4.88	0.8 0.03	154.0 6.06	– –	– –	231.6	63.4	0.1576	4.85 10.69
64433	64700D	3.5 0.14	128.0 5.04	0.8 0.03	172.0 6.77	– –	– –	218.8	45.3	0.1153	8.31 18.31

⁽⁴⁾These maximum fillet radii will be cleared by bearing corners.
NOTE: For spacer configuration information, contact your Timken engineer.

TAPERED ROLLER BEARINGS

DOUBLE-ROW • TYPE TDO

TYPE TDO



Bearing Dimensions				Load Ratings							
Bore d	O.D. D	Width T	Double Outer Ring Width C	Dynamic ⁽¹⁾				Dynamic ⁽³⁾			
				C ₁₍₂₎	e	Y ₁	Y ₂	C ₉₀	C _{a90}	C ₉₀₍₂₎	K
mm in.	mm in.	mm in.	mm in.	N lbf				N lbf	N lbf	N lbf	
111.125 4.3750	190.500 7.5000	106.362 4.1875	80.962 3.1875	633000 142000	0.42	1.62	2.42	94300 21200	67100 15100	164000 36900	1.40
114.300 4.5000	177.800 7.0000	92.075 3.6250	69.850 2.7500	478000 108000	0.52	1.31	1.95	71200 16000	62900 14100	124000 27900	1.13
114.300 4.5000	190.500 7.5000	106.362 4.1875	80.962 3.1875	633000 142000	0.42	1.62	2.42	94300 21200	67100 15100	164000 36900	1.40
114.300 4.5000	212.725 8.3750	142.875 5.6250	117.475 4.6250	996000 224000	0.33	2.07	3.09	148000 33300	82700 18600	258000 58000	1.79
114.300 4.5000	212.725 8.3750	142.875 5.6250	117.475 4.6250	1180000 266000	0.33	2.07	3.09	176000 39600	98300 22100	307000 69000	1.79
114.975 4.5266	212.725 8.3750	142.875 5.6250	117.475 4.6250	1180000 266000	0.33	2.07	3.09	176000 39600	98300 22100	307000 69000	1.79
115.087 4.5310	190.500 7.5000	106.362 4.1875	80.962 3.1875	633000 142000	0.42	1.62	2.42	94300 21200	67100 15100	164000 36900	1.40
119.964 4.7230	215.900 8.5000	106.362 4.1875	80.962 3.1875	665000 150000	0.49	1.38	2.06	99000 22300	82600 18600	172000 38800	1.20
120.650 4.7500	161.925 6.3750	63.500 2.5000	53.975 2.1250	183000 41200	0.43	1.55	2.31	27300 6140	20300 4570	47500 10700	1.34
120.650 4.7500	174.625 6.8750	77.788 3.0625	61.912 2.4375	426000 95700	0.33	2.03	3.02	63400 14200	36100 8110	110000 24800	1.76
120.650 4.7500	182.562 7.1875	85.725 3.3750	73.025 2.8750	466000 105000	0.31	2.21	3.29	69400 15600	36300 8160	121000 27200	1.91
120.650 4.7500	206.375 8.1250	107.950 4.2500	82.550 3.2500	658000 148000	0.46	1.47	2.19	98000 22000	77000 17300	171000 38400	1.27
120.650 4.7500	234.950 9.2500	142.875 5.6250	114.300 4.5000	1090000 246000	0.37	1.83	2.72	163000 36700	103000 23200	284000 63800	1.58
123.825 4.8750	182.562 7.1875	85.725 3.3750	73.025 2.8750	466000 105000	0.31	2.21	3.29	69400 15600	36300 8160	121000 27200	1.91
124.943 4.9190	234.950 9.2500	142.875 5.6250	114.300 4.5000	1090000 246000	0.37	1.83	2.72	163000 36700	103000 23200	284000 63800	1.58
127.000 5.0000	169.975 6.6919	58.738 2.3125	49.212 1.9375	249000 55900	0.33	2.03	3.02	37000 8320	21100 4740	64500 14500	1.76
127.000 5.0000	182.562 7.1875	85.725 3.3750	73.025 2.8750	466000 105000	0.31	2.21	3.29	69400 15600	36300 8160	121000 27200	1.91

⁽¹⁾Based on 1 x 10⁶ revolutions L₁₀ life, for the ISO life-calculation method. C₁₍₂₎ is the double-row radial value.

⁽²⁾Consult your Timken engineer for instructions on use or review the Timken Engineering Manual on timken.com/catalogs.

⁽³⁾Based on 90 x 10⁶ revolutions L₁₀ life, for The Timken Company life-calculation method. C₉₀ and C_{a90} are radial and thrust values for a single row. C₉₀₍₂₎ is the double-row radial value.

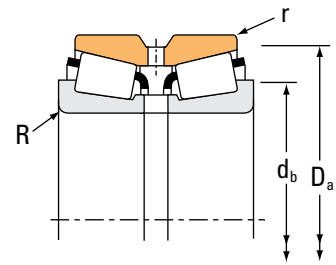
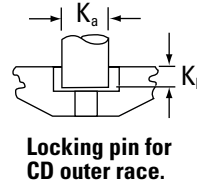
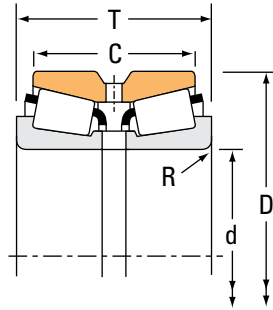
Part Number		Dimensions						Geometry Factors			Bearing Weight
Inner	Outer	Shaft		Housing		Pin		G ₁	G ₂	C _G	
		Max. Shaft Fillet Radius R ⁽⁴⁾	Backing Shoulder Dia. d _b	Max. Housing Fillet Radius r ⁽⁴⁾	Backing Shoulder Dia. D _a	K _a	K _b				
		mm in.	mm in.	mm in.	mm in.	mm in.	mm in.				kg lbs.
71437	71751D	3.6 0.14	129.0 5.08	1.5 0.06	181.0 7.13	– –	– –	269.2	49.5	0.1156	11.52 25.41
64450	64700D	3.5 0.14	131.0 5.16	0.8 0.03	172.0 6.77	– –	– –	218.8	45.3	0.1153	7.81 17.21
71450	71751D	3.6 0.14	132.0 5.20	1.5 0.06	181.0 7.13	– –	– –	269.2	49.5	0.1156	11.12 24.50
938	932CD	7.0 0.28	141.0 5.55	1.5 0.06	193.1 7.60	22.23 0.88	8.73 0.34	338.6	39.8	0.1153	20.31 44.78
HH224346	HH224310CD	7.0 0.28	143.0 5.63	1.5 0.06	201.7 7.94	25.40 1.00	7.95 0.31	366.6	47.9	0.1182	20.46 45.09
HH224349	HH224310CD	7.0 0.28	144.0 5.67	1.5 0.06	201.7 7.94	25.40 1.00	7.95 0.31	366.6	47.9	0.1182	20.33 44.84
71453	71751D	3.5 0.14	133.0 5.24	1.5 0.06	181.0 7.13	– –	– –	269.2	49.5	0.1156	10.91 24.06
74472	74851CD	3.5 0.14	142.0 5.59	1.5 0.06	208.0 8.19	19.05 0.75	7.13 0.28	362.9	68.5	0.1338	15.86 34.95
L624549	L624514D	1.5 0.06	129.0 5.08	0.8 0.03	156.0 6.14	– –	– –	195.2	139.1	0.1509	3.24 7.11
M224749	M224710D	3.5 0.14	135.0 5.31	0.8 0.03	167.9 6.61	– –	– –	279.1	86.6	0.1575	5.65 12.49
48282	48220D	3.5 0.14	137.0 5.39	0.8 0.03	176.0 6.93	– –	– –	353.0	91.4	0.1138	7.83 17.29
795	792CD	3.3 0.13	139.0 5.47	0.8 0.03	198.0 7.80	19.05 0.75	7.95 0.31	326.4	62.0	0.1269	13.69 30.20
95475	95927CD	6.4 0.25	149.0 5.87	1.5 0.06	217.0 8.54	22.23 0.88	8.73 0.34	453.9	59.4	0.1323	26.75 59.00
48286	48220D	3.5 0.14	139.0 5.47	0.8 0.03	176.0 6.93	– –	– –	353.0	91.4	0.1138	7.54 16.65
95491	95927CD	6.4 0.25	152.0 5.98	1.5 0.06	217.0 8.54	22.23 0.88	8.73 0.34	453.9	59.4	0.1323	25.68 56.62
L225849	L225812D	1.5 0.06	136.0 5.35	1.0 0.04	164.0 6.46	– –	– –	253.2	134.6	0.1511	3.41 7.51
48290	48220D	3.5 0.14	141.0 5.55	0.8 0.03	176.0 6.93	– –	– –	353.0	91.4	0.1138	7.09 15.62

⁽⁴⁾These maximum fillet radii will be cleared by bearing corners.
NOTE: For spacer configuration information, contact your Timken engineer.

TAPERED ROLLER BEARINGS

DOUBLE-ROW • TYPE TDO

TYPE TDO



Bearing Dimensions				Load Ratings							
Bore d	O.D. D	Width T	Double Outer Ring Width C	Dynamic ⁽¹⁾				Dynamic ⁽³⁾			
				C ₁₍₂₎	e	Y ₁	Y ₂	C ₉₀	C _{a90}	C ₉₀₍₂₎	K
mm in.	mm in.	mm in.	mm in.	N lbf				N lbf	N lbf	N lbf	
127.000 5.0000	196.850 7.7500	101.600 4.0000	85.725 3.3750	640000 144000	0.34	1.96	2.92	95300 21400	56100 12600	166000 37300	1.70
127.000 5.0000	200.025 7.8750	101.600 4.0000	85.725 3.3750	640000 144000	0.34	1.96	2.92	95300 21400	56100 12600	166000 37300	1.70
127.000 5.0000	206.375 8.1250	107.950 4.2500	82.550 3.2500	587000 132000	0.46	1.47	2.19	87300 19600	68600 15400	152000 34200	1.27
127.000 5.0000	215.900 8.5000	106.362 4.1875	80.962 3.1875	665000 150000	0.49	1.38	2.06	99000 22300	82600 18600	172000 38800	1.20
127.000 5.0000	228.600 9.0000	115.888 4.5625	84.138 3.3125	1020000 230000	0.74	0.92	1.36	152000 34200	192000 43100	265000 59500	0.79
127.000 5.0000	234.950 9.2500	142.875 5.6250	114.300 4.5000	1090000 246000	0.37	1.83	2.72	163000 36700	103000 23200	284000 63800	1.58
128.588 5.0625	206.375 8.1250	107.950 4.2500	82.550 3.2500	658000 148000	0.46	1.47	2.19	98000 22000	77000 17300	171000 38400	1.27
130.000 5.1181	206.375 8.1250	107.950 4.2500	82.550 3.2500	658000 148000	0.46	1.47	2.19	98000 22000	77000 17300	171000 38400	1.27
130.175 5.1250	196.850 7.7500	101.600 4.0000	85.725 3.3750	640000 144000	0.34	1.96	2.92	95300 21400	56100 12600	166000 37300	1.70
130.175 5.1250	200.025 7.8750	101.600 4.0000	85.725 3.3750	640000 144000	0.34	1.96	2.92	95300 21400	56100 12600	166000 37300	1.70
130.175 5.1250	206.375 8.1250	107.950 4.2500	82.550 3.2500	658000 148000	0.46	1.47	2.19	98000 22000	77000 17300	171000 38400	1.27
133.350 5.2500	177.008 6.9688	57.150 2.2500	47.625 1.8750	256000 57600	0.35	1.94	2.89	38100 8570	22700 5110	66400 14900	1.68
133.350 5.2500	190.500 7.5000	85.725 3.3750	73.025 2.8750	492000 111000	0.32	2.10	3.13	73300 16500	40300 9060	128000 28700	1.82
133.350 5.2500	196.850 7.7500	101.600 4.0000	85.725 3.3750	640000 144000	0.34	1.96	2.92	95300 21400	56100 12600	166000 37300	1.70
133.350 5.2500	196.850 7.7500	101.600 4.0000	85.725 3.3750	640000 144000	0.34	1.96	2.92	95300 21400	56100 12600	166000 37300	1.70
133.350 5.2500	200.025 7.8750	101.600 4.0000	85.725 3.3750	640000 144000	0.34	1.96	2.92	95300 21400	56100 12600	166000 37300	1.70
133.350 5.2500	215.900 8.5000	106.362 4.1875	80.962 3.1875	665000 150000	0.49	1.38	2.06	99000 22300	82600 18600	172000 38800	1.20

⁽¹⁾Based on 1 x 10⁶ revolutions L₁₀ life, for the ISO life-calculation method. C₁₍₂₎ is the double-row radial value.

⁽²⁾Consult your Timken engineer for instructions on use or review the Timken Engineering Manual on timken.com/catalogs.

⁽³⁾Based on 90 x 10⁶ revolutions L₁₀ life, for The Timken Company life-calculation method. C₉₀ and C_{a90} are radial and thrust values for a single row. C₉₀₍₂₎ is the double-row radial value.

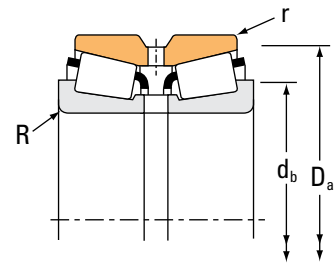
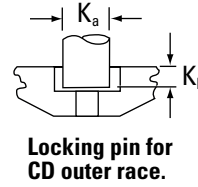
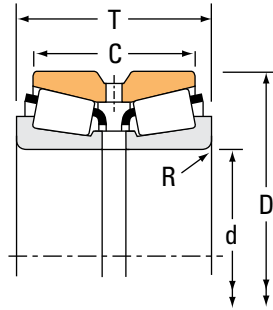
Part Number		Dimensions						Geometry Factors			Bearing Weight
Inner	Outer	Shaft		Housing		Pin		G ₁	G ₂	C _G	
		Max. Shaft Fillet Radius R ⁽⁴⁾	Backing Shoulder Dia. d _b	Max. Housing Fillet Radius r ⁽⁴⁾	Backing Shoulder Dia. D _a	K _a	K _b				
		mm in.	mm in.	mm in.	mm in.	mm in.	mm in.				kg lbs.
67388	67322D	3.5 0.14	144.0 5.67	0.8 0.03	190.0 7.48	– –	– –	383.7	70.1	0.1220	10.71 23.62
67388	67325D	3.5 0.14	144.0 5.67	0.8 0.03	191.0 7.52	– –	– –	383.7	70.1	0.1220	11.36 25.06
798	792CD	3.3 0.13	146.0 5.75	0.8 0.03	198.0 7.80	19.05 0.75	7.95 0.31	307.9	58.6	0.1243	12.49 27.52
74500	74851CD	3.5 0.14	148.0 5.83	1.5 0.06	208.0 8.19	19.05 0.75	7.13 0.28	362.9	68.5	0.1338	14.81 32.66
HM926747	HM926710CD	3.5 0.14	156.0 6.14	2.3 0.09	219.5 8.64	19.05 0.75	8.73 0.34	295.4	39.0	0.1416	18.24 40.22
95500	95927CD	6.4 0.25	154.0 6.06	1.5 0.06	217.0 8.54	22.23 0.88	8.73 0.34	453.9	59.4	0.1323	25.35 55.89
799	792CD	3.3 0.13	146.0 5.75	0.8 0.03	198.0 7.80	19.05 0.75	7.95 0.31	326.4	62.0	0.1269	12.43 27.42
797	792CD	3.5 0.14	148.0 5.83	0.8 0.03	198.0 7.80	19.05 0.75	7.95 0.31	326.4	62.0	0.1269	12.12 26.75
67389	67322D	3.5 0.14	147.0 5.79	0.8 0.03	190.0 7.48	– –	– –	383.7	70.1	0.1220	10.15 22.39
67389	67325D	3.5 0.14	147.0 5.79	0.8 0.03	191.0 7.52	– –	– –	383.7	70.1	0.1220	10.80 23.82
799A	792CD	3.5 0.14	148.0 5.83	0.8 0.03	198.0 7.80	19.05 0.75	7.95 0.31	326.4	62.0	0.1269	12.16 26.81
L327249	L327210D	1.5 0.06	142.0 5.59	0.8 0.03	171.0 6.73	– –	– –	280.1	155.8	0.1585	3.67 8.09
48385	48320D	3.5 0.14	148.0 5.83	0.8 0.03	184.0 7.24	– –	– –	403.8	105.1	0.1209	7.42 16.35
67390	67322D	3.5 0.14	150.0 5.91	0.8 0.03	190.0 7.48	– –	– –	383.7	70.1	0.1220	9.64 21.28
67391	67322D	8.0 0.31	157.0 6.18	0.8 0.03	190.0 7.48	– –	– –	383.7	70.1	0.1220	9.58 21.12
67390	67325D	3.5 0.14	150.0 5.91	0.8 0.03	191.0 7.52	– –	– –	383.7	70.1	0.1220	10.29 22.71
74525	74851CD	3.5 0.14	152.0 5.98	1.5 0.06	208.0 8.19	19.05 0.75	7.13 0.28	362.9	68.5	0.1338	13.84 30.50

⁽⁴⁾These maximum fillet radii will be cleared by bearing corners.
NOTE: For spacer configuration information, contact your Timken engineer.

TAPERED ROLLER BEARINGS

DOUBLE-ROW • TYPE TDO

TYPE TDO



Bearing Dimensions				Load Ratings							
Bore d	O.D. D	Width T	Double Outer Ring Width C	Dynamic ⁽¹⁾				Dynamic ⁽³⁾			
				C ₁₍₂₎	e	Y ₁	Y ₂	C ₉₀	C _{a90}	C ₉₀₍₂₎	K
mm in.	mm in.	mm in.	mm in.	N lbf				N lbf	N lbf	N lbf	
133.350 5.2500	234.950 9.2500	142.875 5.6250	114.300 4.5000	1090000 246000	0.37	1.83	2.72	163000 36700	103000 23200	284000 63800	1.58
133.350 5.2500	234.950 9.2500	142.875 5.6250	114.300 4.5000	1090000 246000	0.37	1.83	2.72	163000 36700	103000 23200	284000 63800	1.58
136.525 5.3750	190.500 7.5000	85.725 3.3750	73.025 2.8750	492000 111000	0.32	2.10	3.13	73300 16500	40300 9060	128000 28700	1.82
136.525 5.3750	215.900 8.5000	106.362 4.1875	80.962 3.1875	665000 150000	0.49	1.38	2.06	99000 22300	82600 18600	172000 38800	1.20
136.525 5.3750	228.600 9.0000	123.825 4.8750	98.425 3.8750	906000 204000	0.42	1.60	2.39	135000 30300	97200 21800	235000 52800	1.39
136.525 5.3750	254.000 10.0000	149.225 5.8750	111.125 4.3750	1150000 258000	0.41	1.66	2.47	171000 38500	119000 26800	298000 67000	1.43
139.700 5.5000	215.900 8.5000	106.362 4.1875	80.962 3.1875	665000 150000	0.49	1.38	2.06	99000 22300	82600 18600	172000 38800	1.20
139.700 5.5000	215.900 8.5000	106.362 4.1875	80.962 3.1875	665000 150000	0.49	1.38	2.06	99000 22300	82600 18600	172000 38800	1.20
139.700 5.5000	222.250 8.7500	75.692 2.9800	53.975 2.1250	510000 115000	0.44	1.54	2.30	75900 17100	56800 12800	132000 29700	1.34
139.700 5.5000	228.600 9.0000	123.825 4.8750	98.425 3.8750	906000 204000	0.42	1.60	2.39	135000 30300	97200 21800	235000 52800	1.39
139.700 5.5000	228.600 9.0000	123.825 4.8750	98.425 3.8750	906000 204000	0.42	1.60	2.39	135000 30300	97200 21800	235000 52800	1.39
139.700 5.5000	236.538 9.3125	131.762 5.1875	106.362 4.1875	1040000 234000	0.32	2.12	3.15	155000 34800	84500 19000	269000 60600	1.83
139.700 5.5000	241.300 9.5000	131.762 5.1875	106.362 4.1875	897000 202000	0.44	1.53	2.27	134000 30000	101000 22700	232000 52300	1.32
139.700 5.5000	254.000 10.0000	149.225 5.8750	111.125 4.3750	1150000 258000	0.41	1.66	2.47	171000 38500	119000 26800	298000 67000	1.43
139.700 5.5000	307.975 12.1250	200.025 7.8750	155.575 6.1250	2010000 451000	0.33	2.07	3.08	299000 67200	167000 37500	520000 117000	1.79
139.700 5.5000	307.975 12.1250	200.025 7.8750	155.575 6.1250	2010000 451000	0.33	2.07	3.08	299000 67200	167000 37500	520000 117000	1.79
142.875 5.6250	200.025 7.8750	87.315 3.4376	73.025 2.8750	499000 112000	0.34	2.01	2.99	74300 16700	42800 9610	129000 29100	1.74

⁽¹⁾Based on 1 x 10⁶ revolutions L₁₀ life, for the ISO life-calculation method. C₁₍₂₎ is the double-row radial value.

⁽²⁾Consult your Timken engineer for instructions on use or review the Timken Engineering Manual on timken.com/catalogs.

⁽³⁾Based on 90 x 10⁶ revolutions L₁₀ life, for The Timken Company life-calculation method. C₉₀ and C_{a90} are radial and thrust values for a single row. C₉₀₍₂₎ is the double-row radial value.

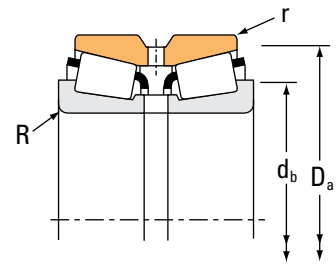
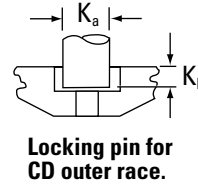
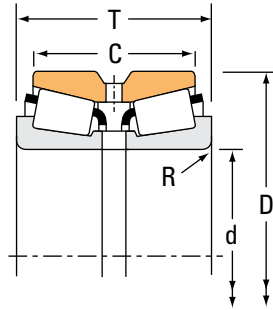
Part Number		Dimensions						Geometry Factors			Bearing Weight
Inner	Outer	Shaft		Housing		Pin		G ₁	G ₂	C _G	
		Max. Shaft Fillet Radius R ⁽⁴⁾	Backing Shoulder Dia. d _b	Max. Housing Fillet Radius r ⁽⁴⁾	Backing Shoulder Dia. D _a	K _a	K _b				
		mm in.	mm in.	mm in.	mm in.	mm in.	mm in.				kg lbs.
95525	95927CD	9.7 0.38	166.0 6.54	1.5 0.06	217.0 8.54	22.23 0.88	8.73 0.34	453.9	59.4	0.1323	23.65 52.14
95528	95927CD	4.8 0.19	157.0 6.18	1.5 0.06	217.0 8.54	22.23 0.88	8.73 0.34	453.9	59.4	0.1323	23.89 52.67
48393	48320D	3.5 0.14	151.0 5.94	0.8 0.03	184.0 7.24	– –	– –	403.8	105.1	0.1209	6.99 15.41
74537	74851CD	3.5 0.14	155.0 6.10	1.5 0.06	208.0 8.19	19.05 0.75	7.13 0.28	362.9	68.5	0.1338	13.21 29.09
896	892CD	3.5 0.14	156.0 6.14	1.5 0.06	216.0 8.50	22.23 0.88	7.13 0.28	430.5	78.3	0.1355	18.81 41.47
99537	99102CD	7.0 0.28	167.0 6.57	1.5 0.06	238.0 9.37	22.23 0.88	7.95 0.31	555.5	73.5	0.1459	30.76 67.79
74550	74851CD	3.5 0.14	158.0 6.22	1.5 0.06	208.0 8.19	19.05 0.75	7.13 0.28	362.9	68.5	0.1338	12.73 28.06
74550A	74851CD	6.4 0.25	166.0 6.54	1.5 0.06	208.0 8.19	19.05 0.75	7.13 0.28	362.9	68.5	0.1338	12.71 28.01
73551	73876CD	3.5 0.14	156.0 6.14	2.3 0.09	207.0 8.15	11.11 0.44	6.35 0.25	244.4	82.0	0.1122	9.36 20.61
898	892CD	3.5 0.14	160.0 6.30	1.5 0.06	216.0 8.50	22.23 0.88	7.13 0.28	430.5	78.3	0.1355	18.09 39.89
898A	892CD	6.4 0.25	165.0 6.50	1.5 0.06	216.0 8.50	22.23 0.88	7.13 0.28	430.5	78.3	0.1355	17.99 39.67
HM231132	HM231111CD	3.5 0.14	160.0 6.30	1.5 0.06	224.0 8.82	22.23 0.88	7.92 0.31	532.8	85.9	0.1327	21.68 47.79
82550	82951CD	3.5 0.14	161.0 6.34	1.5 0.06	226.0 8.90	22.23 0.88	8.73 0.34	460.5	81.1	0.1405	23.09 50.93
99550	99102CD	7.0 0.28	170.0 6.69	1.5 0.06	238.0 9.37	22.23 0.88	7.95 0.31	555.5	73.5	0.1459	30.15 66.47
HH234031	HH234011CD	9.7 0.38	180.0 7.09	2.3 0.09	285.0 11.24	28.58 1.13	10.31 0.41	718.4	62.1	0.1157	65.90 145.26
HH234032	HH234011CD	9.7 0.38	180.0 7.09	2.3 0.09	285.0 11.24	28.58 1.13	10.31 0.41	718.4	62.1	0.1157	66.18 145.90
48685	48620D	3.5 0.14	158.0 6.22	0.8 0.03	193.0 7.60	– –	– –	439.6	130.5	0.1261	8.02 17.68

⁽⁴⁾These maximum fillet radii will be cleared by bearing corners.
NOTE: For spacer configuration information, contact your Timken engineer.

TAPERED ROLLER BEARINGS

DOUBLE-ROW • TYPE TDO

TYPE TDO



Bearing Dimensions				Load Ratings							
Bore d	O.D. D	Width T	Double Outer Ring Width C	Dynamic ⁽¹⁾				Dynamic ⁽³⁾			
				C ₁₍₂₎	e	Y ₁	Y ₂	C ₉₀	C _{a90}	C ₉₀₍₂₎	K
mm in.	mm in.	mm in.	mm in.	N lbf				N lbf	N lbf	N lbf	
142.875 5.6250	222.250 8.7500	75.692 2.9800	53.975 2.1250	510000 115000	0.44	1.54	2.30	75900 17100	56800 12800	132000 29700	1.34
142.875 5.6250	241.300 9.5000	131.762 5.1875	106.362 4.1875	897000 202000	0.44	1.53	2.27	134000 30000	101000 22700	232000 52300	1.32
146.050 5.7500	193.675 7.6250	65.085 2.5624	53.975 2.1250	342000 76900	0.37	1.83	2.73	50900 11400	32100 7220	88600 19900	1.59
146.050 5.7500	236.538 9.3125	131.762 5.1875	106.362 4.1875	1040000 234000	0.32	2.12	3.15	155000 34800	84500 19000	269000 60600	1.83
146.050 5.7500	241.300 9.5000	131.762 5.1875	106.362 4.1875	897000 202000	0.44	1.53	2.27	134000 30000	101000 22700	232000 52300	1.32
146.050 5.7500	244.475 9.6250	107.950 4.2500	79.375 3.1250	699000 157000	0.35	1.92	2.86	104000 23400	62700 14100	181000 40800	1.66
146.050 5.7500	254.000 10.0000	149.225 5.8750	111.125 4.3750	1150000 258000	0.41	1.66	2.47	171000 38500	119000 26800	298000 67000	1.43
149.225 5.8750	236.538 9.3125	131.762 5.1875	106.362 4.1875	1040000 234000	0.32	2.12	3.15	155000 34800	84500 19000	269000 60600	1.83
149.225 5.8750	236.538 9.3125	131.762 5.1875	106.362 4.1875	1040000 234000	0.32	2.12	3.15	155000 34800	84500 19000	269000 60600	1.83
149.225 5.8750	241.300 9.5000	131.762 5.1875	106.362 4.1875	897000 202000	0.44	1.53	2.27	134000 30000	101000 22700	232000 52300	1.32
149.225 5.8750	254.000 10.0000	149.225 5.8750	111.125 4.3750	1150000 258000	0.41	1.66	2.47	171000 38500	119000 26800	298000 67000	1.43
150.000 5.9055	244.475 9.6250	107.950 4.2500	79.375 3.1250	699000 157000	0.35	1.92	2.86	104000 23400	62700 14100	181000 40800	1.66
150.812 5.9375	244.475 9.6250	107.950 4.2500	79.375 3.1250	699000 157000	0.35	1.92	2.86	104000 23400	62700 14100	181000 40800	1.66
152.400 6.0000	203.200 8.0000	92.075 3.6250	79.375 3.1250	493000 111000	0.35	1.94	2.89	73400 16500	43700 9810	128000 28700	1.68
152.400 6.0000	222.250 8.7500	100.010 3.9374	76.200 3.0000	607000 136000	0.33	2.03	3.02	90400 20300	51500 11600	157000 35400	1.76
152.400 6.0000	244.475 9.6250	107.950 4.2500	79.375 3.1250	699000 157000	0.35	1.92	2.86	104000 23400	62700 14100	181000 40800	1.66
152.400 6.0000	254.000 10.0000	149.225 5.8750	111.125 4.3750	1150000 258000	0.41	1.66	2.47	171000 38500	119000 26800	298000 67000	1.43

⁽¹⁾Based on 1 x 10⁶ revolutions L₁₀ life, for the ISO life-calculation method. C₁₍₂₎ is the double-row radial value.

⁽²⁾Consult your Timken engineer for instructions on use or review the Timken Engineering Manual on timken.com/catalogs.

⁽³⁾Based on 90 x 10⁶ revolutions L₁₀ life, for The Timken Company life-calculation method. C₉₀ and C_{a90} are radial and thrust values for a single row. C₉₀₍₂₎ is the double-row radial value.

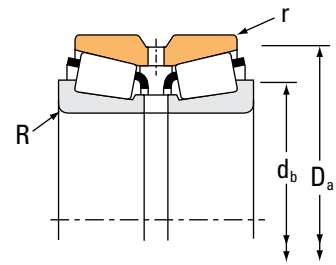
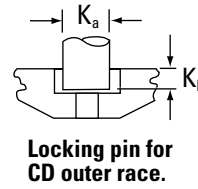
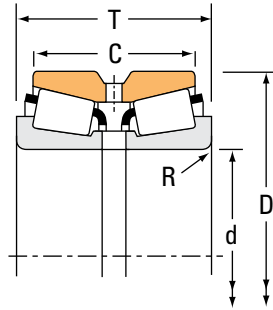
Part Number		Dimensions						Geometry Factors			Bearing Weight
Inner	Outer	Shaft		Housing		Pin		G ₁	G ₂	C _G	
		Max. Shaft Fillet Radius R ⁽⁴⁾	Backing Shoulder Dia. d _b	Max. Housing Fillet Radius r ⁽⁴⁾	Backing Shoulder Dia. D _a	K _a	K _b				
		mm in.	mm in.	mm in.	mm in.	mm in.	mm in.				kg lbs.
73562	73876CD	3.5 0.14	159.0 6.26	2.3 0.09	207.0 8.15	11.11 0.44	6.35 0.25	244.4	82.0	0.1122	8.94 19.70
82562	82951CD	3.5 0.14	163.0 6.42	1.5 0.06	226.0 8.90	22.23 0.88	8.73 0.34	460.5	81.1	0.1405	22.49 49.58
36690	36620D	1.5 0.06	155.0 6.10	0.8 0.03	188.0 7.40	– –	– –	366.1	152.5	0.1768	4.89 10.80
HM231140	HM231111CD	3.5 0.14	164.0 6.46	1.5 0.06	224.0 8.82	22.23 0.88	7.92 0.31	532.8	85.9	0.1327	20.26 44.66
82576	82951CD	3.5 0.14	166.0 6.54	1.5 0.06	226.0 8.90	22.23 0.88	8.73 0.34	460.5	81.1	0.1405	21.80 48.09
81575	81963CD	3.5 0.14	166.1 6.54	1.5 0.06	229.1 9.02	19.05 0.75	7.95 0.31	413.0	98.4	0.1250	17.83 39.30
99575	99102CD	7.0 0.28	175.0 6.89	1.5 0.06	238.0 9.37	22.23 0.88	7.95 0.31	555.5	73.5	0.1459	28.57 62.96
HM231148	HM231111CD	6.4 0.25	172.0 6.77	1.5 0.06	224.0 8.82	22.23 0.88	7.92 0.31	532.8	85.9	0.1327	19.50 42.99
HM231149	HM231111CD	3.5 0.14	167.0 6.57	1.5 0.06	224.0 8.82	22.23 0.88	7.92 0.31	532.8	85.9	0.1327	19.60 43.22
82587	82951CD	3.5 0.14	169.0 6.65	1.5 0.06	226.0 8.90	22.23 0.88	8.73 0.34	460.5	81.1	0.1405	20.98 46.27
99587	99102CD	7.0 0.28	181.0 7.13	1.5 0.06	238.0 9.37	22.23 0.88	7.95 0.31	555.5	73.5	0.1459	27.99 61.69
81590	81963CD	3.5 0.14	168.9 6.65	1.5 0.06	229.1 9.02	19.05 0.75	7.95 0.31	413.0	98.4	0.1250	17.18 37.89
81593	81963CD	3.5 0.14	168.9 6.65	1.5 0.06	229.1 9.02	19.05 0.75	7.95 0.31	413.0	98.4	0.1250	16.99 37.47
LM330448	LM330410D	3.3 0.13	166.0 6.54	0.8 0.03	197.0 7.76	– –	– –	456.5	134.8	0.1289	7.55 16.63
M231649	M231610CD	3.5 0.14	169.0 6.65	0.8 0.03	213.0 8.39	19.05 0.75	7.13 0.28	486.5	120.1	0.1300	11.77 25.96
81600	81963CD	3.5 0.14	170.9 6.73	1.5 0.06	229.1 9.02	19.05 0.75	7.95 0.31	413.0	98.4	0.1250	17.20 37.90
99600	99102CD	7.0 0.28	181.0 7.13	1.5 0.06	238.0 9.37	22.23 0.88	7.95 0.31	555.5	73.5	0.1459	26.98 59.49

⁽⁴⁾These maximum fillet radii will be cleared by bearing corners.
NOTE: For spacer configuration information, contact your Timken engineer.

TAPERED ROLLER BEARINGS

DOUBLE-ROW • TYPE TDO

TYPE TDO



Bearing Dimensions				Load Ratings							
Bore d	O.D. D	Width T	Double Outer Ring Width C	Dynamic ⁽¹⁾				Dynamic ⁽³⁾			
				C ₁₍₂₎	e	Y ₁	Y ₂	C ₉₀	C _{a90}	C ₉₀₍₂₎	K
mm in.	mm in.	mm in.	mm in.	N lbf				N lbf	N lbf	N lbf	
152.400 6.0000	268.288 10.5625	160.338 6.3125	125.412 4.9375	1370000 307000	0.39	1.74	2.59	203000 45700	135000 30300	354000 79600	1.51
152.400 6.0000	307.975 12.1250	200.025 7.8750	146.050 5.7500	1830000 412000	0.33	2.07	3.08	273000 61400	152000 34300	475000 107000	1.79
152.400 6.0000	307.975 12.1250	200.025 7.8750	155.575 6.1250	2010000 451000	0.33	2.07	3.08	299000 67200	167000 37500	520000 117000	1.79
152.400 6.0000	307.975 12.1250	200.025 7.8750	155.575 6.1250	2130000 478000	0.33	2.07	3.08	316000 71100	177000 39700	551000 124000	1.79
153.988 6.0625	244.475 9.6250	107.950 4.2500	79.375 3.1250	699000 157000	0.35	1.92	2.86	104000 23400	62700 14100	181000 40800	1.66
158.750 6.2500	225.425 8.8750	85.725 3.3750	69.850 2.7500	528000 119000	0.38	1.76	2.62	78600 17700	51600 11600	137000 30800	1.52
159.950 6.2973	244.475 9.6250	107.950 4.2500	79.375 3.1250	699000 157000	0.35	1.92	2.86	104000 23400	62700 14100	181000 40800	1.66
159.950 6.2973	244.475 9.6250	107.950 4.2500	79.375 3.1250	699000 157000	0.35	1.92	2.86	104000 23400	62700 14100	181000 40800	1.66
160.325 6.3120	288.925 11.3750	142.875 5.6250	111.125 4.3750	1700000 382000	0.32	2.12	3.15	253000 56900	138000 31100	441000 99100	1.83
165.100 6.5000	225.425 8.8750	85.725 3.3750	69.850 2.7500	528000 119000	0.38	1.76	2.62	78600 17700	51600 11600	137000 30800	1.52
165.100 6.5000	247.650 9.7500	103.188 4.0625	84.138 3.3125	705000 159000	0.44	1.54	2.29	105000 23600	79000 17800	183000 41100	1.33
165.100 6.5000	254.000 10.0000	101.600 4.0000	76.200 3.0000	893000 201000	0.32	2.12	3.15	133000 29900	72600 16300	231000 52000	1.83
165.100 6.5000	288.925 11.3750	142.875 5.6250	111.125 4.3750	1150000 258000	0.47	1.44	2.15	171000 38500	137000 30800	298000 67000	1.25
165.100 6.5000	288.925 11.3750	142.875 5.6250	111.125 4.3750	1700000 382000	0.32	2.12	3.15	253000 56900	138000 31100	441000 99100	1.83
166.688 6.5625	225.425 8.8750	85.725 3.3750	69.850 2.7500	528000 119000	0.38	1.76	2.62	78600 17700	51600 11600	137000 30800	1.52
168.275 6.6250	247.650 9.7500	103.188 4.0625	84.138 3.3125	705000 159000	0.44	1.54	2.29	105000 23600	79000 17800	183000 41100	1.33
170.000 6.6929	254.000 10.0000	101.600 4.0000	76.200 3.0000	893000 201000	0.32	2.12	3.15	133000 29900	72600 16300	231000 52000	1.83

⁽¹⁾Based on 1 x 10⁶ revolutions L₁₀ life, for the ISO life-calculation method. C₁₍₂₎ is the double-row radial value.

⁽²⁾Consult your Timken engineer for instructions on use or review the Timken Engineering Manual on timken.com/catalogs.

⁽³⁾Based on 90 x 10⁶ revolutions L₁₀ life, for The Timken Company life-calculation method. C₉₀ and C_{a90} are radial and thrust values for a single row. C₉₀₍₂₎ is the double-row radial value.

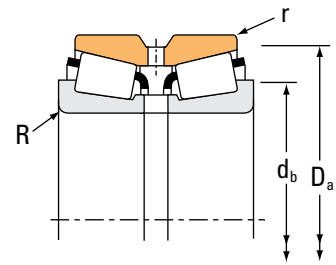
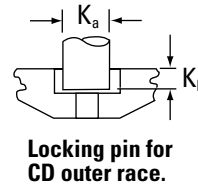
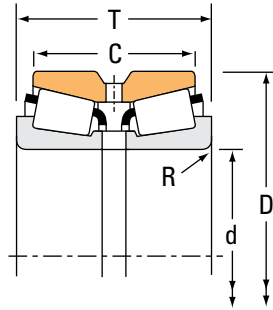
Part Number		Dimensions						Geometry Factors			Bearing Weight
Inner	Outer	Shaft		Housing		Pin		G ₁	G ₂	C _g	
		Max. Shaft Fillet Radius R ⁽⁴⁾	Backing Shoulder Dia. d _b	Max. Housing Fillet Radius r ⁽⁴⁾	Backing Shoulder Dia. D _a	K _a	K _b				
		mm in.	mm in.	mm in.	mm in.	mm in.	mm in.				kg lbs.
EE107060	107105CD	6.4 0.25	181.0 7.13	1.5 0.06	249.4 9.82	28.58 1.13	10.34 0.41	606.1	76.3	0.1163	34.82 76.74
EE450601	451215CD	9.7 0.38	189.0 7.44	2.3 0.09	274.8 10.82	28.58 1.13	11.91 0.47	747.4	76.3	0.1176	60.77 133.98
HH234048	HH234011CD	9.7 0.38	191.0 7.52	2.3 0.09	285.0 11.24	28.58 1.13	10.31 0.41	718.4	62.1	0.1157	61.38 135.32
HH234049	HH234011CD	9.7 0.38	191.0 7.52	2.3 0.09	285.0 11.24	28.58 1.13	10.31 0.41	718.4	62.1	0.1157	61.66 135.93
81606	81963CD	3.5 0.14	172.0 6.77	1.5 0.06	229.1 9.02	19.05 0.75	7.95 0.31	413.0	98.4	0.1250	16.54 36.46
46780	46720CD	3.5 0.14	176.0 6.93	0.8 0.03	218.0 8.58	15.88 0.63	5.56 0.22	572.0	174.7	0.1432	10.58 23.34
81629	81963CD	3.5 0.14	176.0 6.93	1.5 0.06	229.1 9.02	19.05 0.75	7.95 0.31	413.0	98.4	0.1250	15.22 33.56
81630	81963CD	3.5 0.14	176.0 6.93	1.5 0.06	229.1 9.02	19.05 0.75	7.95 0.31	413.0	98.4	0.1250	15.40 33.95
HM237532	HM237510CD	7.0 0.28	192.0 7.56	1.5 0.06	271.5 10.69	22.23 0.88	8.73 0.34	751.2	101.5	0.1168	37.00 81.55
46790	46720CD	3.5 0.14	181.0 7.13	0.8 0.03	218.0 8.58	15.88 0.63	5.56 0.22	572.0	174.7	0.1432	9.54 21.02
67780	67720CD	3.5 0.14	185.0 7.28	0.8 0.03	240.0 9.45	19.05 0.75	7.13 0.28	622.3	122.6	0.1214	16.76 36.96
M235145	M235113CD	4.8 0.19	185.0 7.28	1.5 0.06	240.0 9.45	19.05 0.75	7.95 0.31	531.4	107.5	0.1037	16.54 36.44
94649	94114CD	7.0 0.28	197.0 7.76	1.5 0.06	272.0 10.71	22.23 0.88	10.34 0.41	692.3	93.9	0.1287	36.99 81.56
HM237535	HM237510CD	7.0 0.28	195.0 7.68	1.5 0.06	271.5 10.69	22.23 0.88	8.73 0.34	751.2	101.5	0.1168	35.79 78.88
46792	46720CD	3.5 0.14	182.0 7.17	0.8 0.03	218.0 8.58	15.88 0.63	5.56 0.22	572.0	174.7	0.1432	9.28 20.44
67782	67720CD	3.5 0.14	187.0 7.36	0.8 0.03	240.0 9.45	19.05 0.75	7.13 0.28	622.3	122.6	0.1214	16.02 35.34
M235149	M235113CD	4.8 0.19	189.0 7.44	1.5 0.06	240.0 9.45	19.05 0.75	7.95 0.31	531.4	107.5	0.1037	15.43 34.00

⁽⁴⁾These maximum fillet radii will be cleared by bearing corners.
NOTE: For spacer configuration information, contact your Timken engineer.

TAPERED ROLLER BEARINGS

DOUBLE-ROW • TYPE TDO

TYPE TDO



Bearing Dimensions				Load Ratings							
Bore d	O.D. D	Width T	Double Outer Ring Width C	Dynamic ⁽¹⁾		Factors ⁽²⁾		Dynamic ⁽³⁾			Factors ⁽²⁾
				C ₁₍₂₎	e	Y ₁	Y ₂	C ₉₀	C _{a90}	C ₉₀₍₂₎	K
mm in.	mm in.	mm in.	mm in.	N lbf				N lbf	N lbf	N lbf	
171.450 6.7500	288.925 11.3750	142.875 5.6250	111.125 4.3750	1150000 258000	0.47	1.44	2.15	171000 38500	137000 30800	298000 67000	1.25
174.625 6.8750	247.650 9.7500	103.188 4.0625	84.138 3.3125	705000 159000	0.44	1.54	2.29	105000 23600	79000 17800	183000 41100	1.33
174.625 6.8750	247.650 9.7500	103.188 4.0625	84.138 3.3125	705000 159000	0.44	1.54	2.29	105000 23600	79000 17800	183000 41100	1.33
174.625 6.8750	288.925 11.3750	142.875 5.6250	111.125 4.3750	1150000 258000	0.47	1.44	2.15	171000 38500	137000 30800	298000 67000	1.25
174.625 6.8750	288.925 11.3750	142.875 5.6250	111.125 4.3750	1700000 382000	0.32	2.12	3.15	253000 56900	138000 31100	441000 99100	1.83
177.800 7.0000	227.012 8.9375	66.672 2.6249	52.388 2.0625	364000 81800	0.44	1.53	2.28	54200 12200	40900 9190	94400 21200	1.33
177.800 7.0000	247.650 9.7500	103.188 4.0625	84.138 3.3125	705000 159000	0.44	1.54	2.29	105000 23600	79000 17800	183000 41100	1.33
177.800 7.0000	247.650 9.7500	103.188 4.0625	84.138 3.3125	705000 159000	0.44	1.54	2.29	105000 23600	79000 17800	183000 41100	1.33
177.800 7.0000	269.875 10.6250	119.062 4.6875	93.662 3.6875	884000 199000	0.33	2.03	3.02	132000 29600	74900 16800	229000 51500	1.76
177.800 7.0000	288.925 11.3750	142.875 5.6250	111.125 4.3750	1150000 258000	0.47	1.44	2.15	171000 38500	137000 30800	298000 67000	1.25
177.800 7.0000	288.925 11.3750	142.875 5.6250	111.125 4.3750	1700000 382000	0.32	2.12	3.15	253000 56900	138000 31100	441000 99100	1.83
177.800 7.0000	288.925 11.3750	142.875 5.6250	111.125 4.3750	1700000 382000	0.32	2.12	3.15	253000 56900	138000 31100	441000 99100	1.83
177.800 7.0000	320.675 12.6250	185.738 7.3125	138.112 5.4375	1660000 374000	0.40	1.69	2.51	247000 55600	169000 38100	431000 96900	1.46
177.800 7.0000	320.675 12.6250	185.738 7.3125	138.112 5.4375	1830000 410000	0.32	2.12	3.15	272000 61100	148000 33400	473000 106000	1.83
179.975 7.0856	317.500 12.5000	146.050 5.7500	111.125 4.3750	1270000 286000	0.52	1.29	1.92	190000 42600	170000 38200	330000 74200	1.12
184.150 7.2500	266.700 10.5000	103.188 4.0625	84.138 3.3125	725000 163000	0.48	1.41	2.11	108000 24300	88200 19800	188000 42300	1.22
187.325 7.3750	266.700 10.5000	103.188 4.0625	84.138 3.3125	725000 163000	0.48	1.41	2.11	108000 24300	88200 19800	188000 42300	1.22

⁽¹⁾Based on 1 x 10⁶ revolutions L₁₀ life, for the ISO life-calculation method. C₁₍₂₎ is the double-row radial value.

⁽²⁾Consult your Timken engineer for instructions on use or review the Timken Engineering Manual on timken.com/catalogs.

⁽³⁾Based on 90 x 10⁶ revolutions L₁₀ life, for The Timken Company life-calculation method. C₉₀ and C_{a90} are radial and thrust values for a single row. C₉₀₍₂₎ is the double-row radial value.

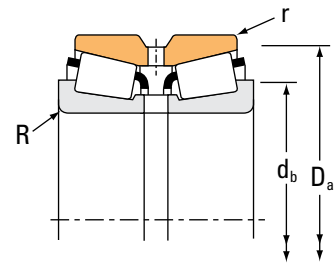
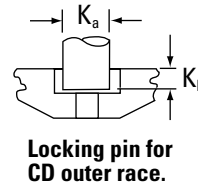
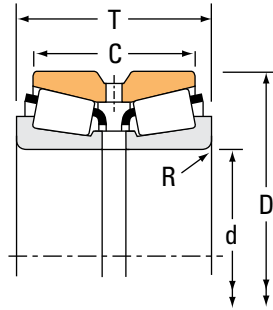
Part Number		Dimensions						Geometry Factors			Bearing Weight
Inner	Outer	Shaft		Housing		Pin		G ₁	G ₂	C _G	
		Max. Shaft Fillet Radius R ⁽⁴⁾	Backing Shoulder Dia. d _b	Max. Housing Fillet Radius r ⁽⁴⁾	Backing Shoulder Dia. D _a	K _a	K _b				
		mm in.	mm in.	mm in.	mm in.	mm in.	mm in.				kg lbs.
94675	94114CD	7.0 0.28	202.0 7.95	1.5 0.06	272.0 10.71	22.23 0.88	10.34 0.41	692.3	93.9	0.1287	35.08 77.34
67786	67720CD	8.0 0.31	200.0 7.87	0.8 0.03	240.0 9.45	19.05 0.75	7.13 0.28	622.3	122.6	0.1214	14.61 32.20
67787	67720CD	3.5 0.14	192.0 7.56	0.8 0.03	240.0 9.45	19.05 0.75	7.13 0.28	622.3	122.6	0.1214	14.69 32.40
94687	94114CD	7.0 0.28	204.0 8.03	1.5 0.06	272.0 10.71	22.23 0.88	10.34 0.41	692.3	93.9	0.1287	34.23 75.46
HM237542	HM237510CD	7.0 0.28	202.0 7.95	1.5 0.06	271.5 10.69	22.23 0.88	8.73 0.34	751.2	101.5	0.1168	33.13 73.04
36990	36920CD	1.5 0.06	188.0 7.40	0.8 0.03	221.0 8.70	11.11 0.44	4.65 0.18	514.8	241.1	0.1434	6.13 13.54
67790	67720CD	3.5 0.14	194.0 7.64	0.8 0.03	240.0 9.45	19.05 0.75	7.13 0.28	622.3	122.6	0.1214	14.01 30.87
67791	67720CD	10.5 0.41	208.0 8.19	0.8 0.03	240.0 9.45	19.05 0.75	7.13 0.28	622.3	122.6	0.1214	13.81 30.46
M238840	M238810CD	3.5 0.14	198.0 7.80	1.5 0.06	256.0 10.08	19.05 0.75	7.95 0.31	788.3	118.1	0.1201	22.99 50.70
94700	94114CD	7.0 0.28	207.0 8.15	1.5 0.06	272.0 10.71	22.23 0.88	10.34 0.41	692.3	93.9	0.1287	33.31 73.47
HM237545	HM237510CD	7.0 0.28	205.0 8.07	1.5 0.06	271.5 10.69	22.23 0.88	8.73 0.34	751.2	101.5	0.1168	32.29 71.19
HM237545H	HM237510CD	7.0 0.28	207.0 8.15	1.5 0.06	271.5 10.69	22.23 0.88	8.73 0.34	751.2	101.5	0.1168	32.42 71.49
EE222070	222127CD	3.5 0.14	204.0 8.03	1.5 0.06	298.0 11.73	28.58 1.13	11.91 0.47	947.4	104.7	0.1362	60.47 133.30
H239640	H239612CD	3.5 0.14	202.0 7.95	1.5 0.06	301.0 11.84	28.58 1.13	10.31 0.41	905.7	90.3	0.1242	57.18 126.05
93708	93127CD	3.5 0.14	209.0 8.23	1.5 0.06	298.5 11.75	22.23 0.88	10.31 0.41	912.5	126.1	0.1460	46.95 103.54
67883	67820CD	3.5 0.14	204.0 8.03	0.8 0.03	259.0 10.20	22.23 0.88	7.13 0.28	727.9	146.6	0.1310	18.18 40.07
67884	67820CD	3.5 0.14	206.0 8.11	0.8 0.03	259.0 10.20	22.23 0.88	7.13 0.28	727.9	146.6	0.1310	17.42 38.39

⁽⁴⁾These maximum fillet radii will be cleared by bearing corners.
NOTE: For spacer configuration information, contact your Timken engineer.

TAPERED ROLLER BEARINGS

DOUBLE-ROW • TYPE TDO

TYPE TDO



Bearing Dimensions				Load Ratings							
Bore d	O.D. D	Width T	Double Outer Ring Width C	Dynamic ⁽¹⁾				Dynamic ⁽³⁾			
				C ₁₍₂₎	e	Y ₁	Y ₂	C ₉₀	C _{a90}	C ₉₀₍₂₎	K
mm in.	mm in.	mm in.	mm in.	N lbf				N lbf	N lbf	N lbf	
187.325 7.3750	269.875 10.6250	119.062 4.6875	93.662 3.6875	955000 215000	0.33	2.03	3.02	142000 32000	80900 18200	247000 55600	1.76
187.325 7.3750	320.675 12.6250	185.738 7.3125	138.112 5.4375	1830000 410000	0.32	2.12	3.15	272000 61100	148000 33400	473000 106000	1.83
190.500 7.5000	266.700 10.5000	103.188 4.0625	84.138 3.3125	725000 163000	0.48	1.41	2.11	108000 24300	88200 19800	188000 42300	1.22
190.500 7.5000	317.500 12.5000	146.050 5.7500	111.125 4.3750	1270000 286000	0.52	1.29	1.92	190000 42600	170000 38200	330000 74200	1.12
190.500 7.5000	368.300 14.5000	193.675 7.6250	136.525 5.3750	2030000 457000	0.40	1.68	2.50	303000 68100	208000 46800	527000 118000	1.45
192.088 7.5625	266.700 10.5000	103.188 4.0625	84.138 3.3125	725000 163000	0.48	1.41	2.11	108000 24300	88200 19800	188000 42300	1.22
196.850 7.7500	257.175 10.1250	85.725 3.3750	66.675 2.6250	554000 125000	0.45	1.51	2.25	82500 18600	63100 14200	144000 32300	1.31
196.850 7.7500	317.500 12.5000	146.050 5.7500	111.125 4.3750	1270000 286000	0.52	1.29	1.92	190000 42600	170000 38200	330000 74200	1.12
200.025 7.8750	292.100 11.5000	125.415 4.9376	101.600 4.0000	1040000 235000	0.33	2.03	3.02	156000 35000	88500 19900	271000 60900	1.76
200.025 7.8750	317.500 12.5000	146.050 5.7500	111.125 4.3750	1270000 286000	0.52	1.29	1.92	190000 42600	170000 38200	330000 74200	1.12
200.025 7.8750	333.375 13.1250	149.225 5.8750	114.300 4.5000	1600000 359000	0.44	1.54	2.29	238000 53400	179000 40200	414000 93000	1.33
200.025 7.8750	384.175 15.1250	238.125 9.3750	193.675 7.6250	2920000 656000	0.33	2.03	3.02	434000 97600	247000 55600	756000 170000	1.76
200.025 7.8750	384.175 15.1250	238.125 9.3750	193.675 7.6250	3080000 693000	0.33	2.03	3.02	459000 103000	261000 58800	800000 180000	1.76
203.200 8.0000	282.575 11.1250	101.600 4.0000	82.550 3.2500	875000 197000	0.51	1.33	1.97	130000 29300	114000 25500	227000 51000	1.15
203.200 8.0000	292.100 11.5000	109.538 4.3125	84.138 3.3125	1170000 263000	0.40	1.69	2.51	174000 39100	119000 26800	303000 68200	1.46
203.200 8.0000	292.100 11.5000	125.415 4.9376	101.600 4.0000	1040000 235000	0.33	2.03	3.02	156000 35000	88500 19900	271000 60900	1.76
203.200 8.0000	292.100 11.5000	125.415 4.9376	101.600 4.0000	1200000 269000	0.33	2.03	3.02	178000 40100	102000 22800	311000 69800	1.76

⁽¹⁾Based on 1 x 10⁶ revolutions L₁₀ life, for the ISO life-calculation method. C₁₍₂₎ is the double-row radial value.

⁽²⁾Consult your Timken engineer for instructions on use or review the Timken Engineering Manual on timken.com/catalogs.

⁽³⁾Based on 90 x 10⁶ revolutions L₁₀ life, for The Timken Company life-calculation method. C₉₀ and C_{a90} are radial and thrust values for a single row. C₉₀₍₂₎ is the double-row radial value.

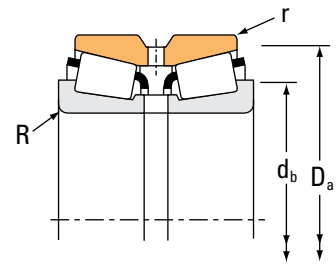
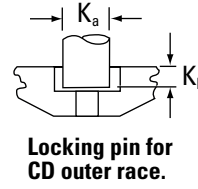
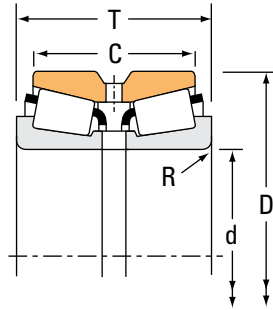
Part Number		Dimensions						Geometry Factors			Bearing Weight
Inner	Outer	Shaft		Housing		Pin		G ₁	G ₂	C _g	
		Max. Shaft Fillet Radius R ⁽⁴⁾	Backing Shoulder Dia. d _b	Max. Housing Fillet Radius r ⁽⁴⁾	Backing Shoulder Dia. D _a	K _a	K _b				
		mm in.	mm in.	mm in.	mm in.	mm in.	mm in.				kg lbs.
M238849	M238810CD	3.5 0.14	205.0 8.07	1.5 0.06	256.0 10.08	19.05 0.75	7.95 0.31	788.3	118.1	0.1201	20.41 44.98
H239649	H239612CD	5.5 0.22	214.0 8.43	1.5 0.06	301.0 11.84	28.58 1.13	10.31 0.41	905.7	90.3	0.1242	53.16 117.18
67885	67820CD	3.5 0.14	209.0 8.23	0.8 0.03	259.0 10.20	22.23 0.88	7.13 0.28	727.9	146.6	0.1310	16.70 36.81
93750	93127CD	4.3 0.17	218.0 8.58	1.5 0.06	298.5 11.75	22.23 0.88	10.31 0.41	912.5	126.1	0.1460	43.25 95.35
EE420751	421451CD	6.4 0.25	227.0 8.94	1.5 0.06	334.4 13.16	25.40 1.00	11.91 0.47	1150.5	128.2	0.1450	84.09 185.38
67887	67820CD	10.5 0.41	223.0 8.78	0.8 0.03	259.0 10.20	22.23 0.88	7.13 0.28	727.9	146.6	0.1310	15.86 34.97
LM739749	LM739710CD	3.5 0.14	213.0 8.39	0.8 0.03	251.0 9.88	14.29 0.56	6.35 0.25	761.7	232.3	0.1296	11.13 24.55
93775	93127CD	4.3 0.17	223.0 8.78	1.5 0.06	298.5 11.75	22.23 0.88	10.31 0.41	912.5	126.1	0.1460	41.22 90.89
M241543	M241510CD	3.5 0.14	219.0 8.62	1.5 0.06	279.0 10.98	19.05 0.75	8.73 0.34	954.1	127.9	0.1279	26.22 57.82
93787	93127CD	4.3 0.17	225.0 8.86	1.5 0.06	298.5 11.75	22.23 0.88	10.31 0.41	912.5	126.1	0.1460	40.20 88.66
HM743337	HM743310CD	6.4 0.25	231.0 9.09	1.5 0.06	317.0 12.48	25.40 1.00	8.73 0.34	1017.2	140.1	0.1433	49.59 109.32
H247535	H247510CD	6.4 0.25	241.0 9.49	1.5 0.06	362.1 14.26	28.58 1.13	11.91 0.47	1964.4	148.4	0.1638	123.87 273.09
H247536	H247510CD	6.4 0.25	241.0 9.49	1.5 0.06	362.1 14.26	28.58 1.13	11.91 0.47	2077.6	156.6	0.1671	127.26 280.53
67983	67920CD	3.5 0.14	222.0 8.74	0.8 0.03	275.0 10.83	19.05 0.75	7.13 0.28	819.5	172.0	0.1388	18.43 40.63
M541349	M541310CD	3.5 0.14	221.0 8.70	0.8 0.03	281.0 11.06	19.05 0.75	7.95 0.31	751.6	147.3	0.1253	21.67 47.78
M241547	M241510CD	3.5 0.14	221.0 8.70	1.5 0.06	279.0 10.98	19.05 0.75	8.73 0.34	954.1	127.9	0.1279	25.17 55.48
M241547H	M241510CD	3.5 0.14	221.0 8.70	1.5 0.06	279.0 10.98	19.05 0.75	8.73 0.34	954.1	127.9	0.1279	25.17 55.48

⁽⁴⁾These maximum fillet radii will be cleared by bearing corners.
NOTE: For spacer configuration information, contact your Timken engineer.

TAPERED ROLLER BEARINGS

DOUBLE-ROW • TYPE TDO

TYPE TDO



Bearing Dimensions				Load Ratings							
Bore d	O.D. D	Width T	Double Outer Ring Width C	Dynamic ⁽¹⁾		Factors ⁽²⁾		Dynamic ⁽³⁾			Factors ⁽²⁾
				C ₁₍₂₎	e	Y ₁	Y ₂	C ₉₀	C _{a90}	C ₉₀₍₂₎	K
mm in.	mm in.	mm in.	mm in.	N lbf				N lbf	N lbf	N lbf	
203.200 8.0000	317.500 12.5000	146.050 5.7500	111.125 4.3750	1270000 286000	0.52	1.29	1.92	190000 42600	170000 38200	330000 74200	1.12
203.200 8.0000	317.500 12.5000	146.050 5.7500	111.125 4.3750	1570000 352000	0.52	1.29	1.92	233000 52500	209000 47000	406000 91300	1.12
203.200 8.0000	368.300 14.5000	193.675 7.6250	136.525 5.3750	2030000 457000	0.40	1.68	2.50	303000 68100	208000 46800	527000 118000	1.45
203.238 8.0015	406.400 16.0000	196.850 7.7500	127.000 5.0000	2120000 477000	0.80	0.85	1.26	316000 71000	431000 97000	550000 124000	0.73
204.788 8.0625	292.100 11.5000	125.415 4.9376	101.600 4.0000	1040000 235000	0.33	2.03	3.02	156000 35000	88500 19900	271000 60900	1.76
206.375 8.1250	282.575 11.1250	101.600 4.0000	82.550 3.2500	875000 197000	0.51	1.33	1.97	130000 29300	114000 25500	227000 51000	1.15
206.375 8.1250	317.500 12.5000	127.000 5.0000	88.900 3.5000	919000 207000	0.31	2.15	3.21	137000 30800	73400 16500	238000 53600	1.86
206.375 8.1250	336.550 13.2500	211.137 8.3125	169.862 6.6875	2360000 530000	0.33	2.03	3.02	351000 79000	200000 45000	612000 137000	1.76
209.550 8.2500	282.575 11.1250	101.600 4.0000	82.550 3.2500	875000 197000	0.51	1.33	1.97	130000 29300	114000 25500	227000 51000	1.15
209.550 8.2500	317.500 12.5000	146.050 5.7500	111.125 4.3750	1270000 286000	0.52	1.29	1.92	190000 42600	170000 38200	330000 74200	1.12
209.550 8.2500	317.500 12.5000	146.050 5.7500	111.125 4.3750	1270000 286000	0.52	1.29	1.92	190000 42600	170000 38200	330000 74200	1.12
209.550 8.2500	319.976 12.5975	146.050 5.7500	111.215 4.3750	1270000 286000	0.52	1.29	1.92	190000 42600	170000 38200	330000 74200	1.12
209.550 8.2500	333.375 13.1250	149.225 5.8750	114.300 4.5000	1600000 359000	0.44	1.54	2.29	238000 53400	179000 40200	414000 93000	1.33
209.550 8.2500	355.600 14.0000	152.400 6.0000	111.125 4.3750	1320000 297000	0.59	1.14	1.70	197000 44200	199000 44700	343000 77000	0.99
212.725 8.3750	285.750 11.2500	98.425 3.8750	76.200 3.0000	748000 168000	0.48	1.40	2.09	111000 25000	91800 20600	194000 43600	1.21
215.900 8.5000	285.750 11.2500	98.425 3.8750	76.200 3.0000	659000 148000	0.48	1.40	2.09	98100 22100	80800 18200	171000 38400	1.21
215.900 8.5000	285.750 11.2500	98.425 3.8750	76.200 3.0000	748000 168000	0.48	1.40	2.09	111000 25000	91800 20600	194000 43600	1.21

⁽¹⁾Based on 1 x 10⁶ revolutions L₁₀ life, for the ISO life-calculation method. C₁₍₂₎ is the double-row radial value.

⁽²⁾Consult your Timken engineer for instructions on use or review the Timken Engineering Manual on timken.com/catalogs.

⁽³⁾Based on 90 x 10⁶ revolutions L₁₀ life, for The Timken Company life-calculation method. C₉₀ and C_{a90} are radial and thrust values for a single row. C₉₀₍₂₎ is the double-row radial value.

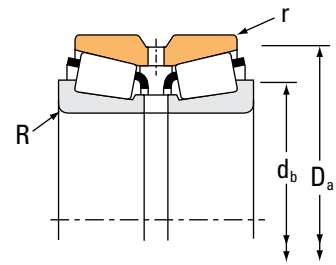
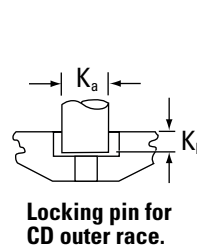
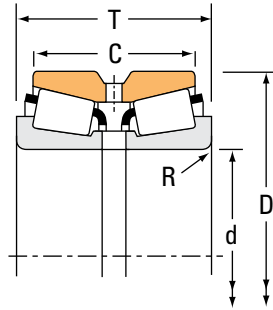
Part Number		Dimensions						Geometry Factors			Bearing Weight
Inner	Outer	Shaft		Housing		Pin		G ₁	G ₂	C _g	
		Max. Shaft Fillet Radius R ⁽⁴⁾	Backing Shoulder Dia. d _b	Max. Housing Fillet Radius r ⁽⁴⁾	Backing Shoulder Dia. D _a	K _a	K _b				
		mm in.	mm in.	mm in.	mm in.	mm in.	mm in.				kg lbs.
93800	93127CD	4.3 0.17	227.0 8.94	1.5 0.06	298.5 11.75	22.23 0.88	10.31 0.41	912.5	126.1	0.1460	39.15 86.33
DX641856	DX979640	4.3 0.17	227.0 8.94	1.5 0.06	298.5 11.75	22.23 0.88	10.31 0.41	912.5	126.1	0.1460	39.15 86.33
EE420801	421451CD	3.3 0.13	230.1 9.06	1.5 0.06	334.4 13.16	25.40 1.00	11.91 0.47	1150.5	128.2	0.1450	78.57 173.20
EE114081	114161D	6.4 0.25	246.0 9.69	3.3 0.13	373.7 14.71	– –	– –	794.7	80.2	0.1571	101.81 224.48
M241549	M241510CD	3.5 0.14	223.0 8.78	1.5 0.06	279.0 10.98	19.05 0.75	8.73 0.34	954.1	127.9	0.1279	24.66 54.35
67985	67920CD	3.5 0.14	224.0 8.82	0.8 0.03	275.0 10.83	19.05 0.75	7.13 0.28	819.5	172.0	0.1388	17.63 38.87
EE132084	132126D	4.0 0.16	227.1 8.94	1.5 0.06	293.1 11.54	– –	– –	797.8	124.6	0.1174	33.32 73.45
H242649	H242610CD	3.3 0.13	231.0 9.09	1.5 0.06	318.0 12.51	28.58 1.13	10.34 0.41	1404.1	134.8	0.1465	68.60 151.22
67989	67920CD	3.5 0.14	227.0 8.94	0.8 0.03	275.0 10.83	19.05 0.75	7.13 0.28	819.5	172.0	0.1388	16.98 37.43
93825	93127CD	4.3 0.17	233.0 9.17	1.5 0.06	298.5 11.75	22.23 0.88	10.31 0.41	912.5	126.1	0.1460	37.02 81.62
93825A	93127CD	12.7 0.50	250.0 9.84	1.5 0.06	298.5 11.75	22.23 0.88	10.31 0.41	912.5	126.1	0.1460	36.70 80.90
93825	93128XD	4.3 0.17	233.0 9.17	1.5 0.06	300.0 11.81	– –	– –	912.5	126.1	0.1460	37.23 82.08
HM743345	HM743310CD	6.4 0.25	238.0 9.37	1.5 0.06	317.0 12.48	25.40 1.00	8.73 0.34	1017.2	140.1	0.1433	46.00 101.41
96825	96140CD	7.0 0.28	246.0 9.69	1.5 0.06	334.0 13.15	25.40 1.00	9.52 0.38	1140.0	160.6	0.1626	57.24 126.20
LM742745	LM742710CD	3.5 0.14	230.0 9.06	0.8 0.03	279.0 10.98	17.45 0.69	7.13 0.28	866.9	225.2	0.1388	16.58 36.55
LM742748	LM742710CD	3.5 0.14	233.0 9.17	0.8 0.03	279.0 10.98	17.45 0.69	7.13 0.28	808.2	210.6	0.1354	15.54 34.25
LM742749	LM742710CD	3.5 0.14	233.0 9.17	0.8 0.03	279.0 10.98	17.45 0.69	7.13 0.28	866.9	225.2	0.1388	15.78 34.78

⁽⁴⁾These maximum fillet radii will be cleared by bearing corners.
NOTE: For spacer configuration information, contact your Timken engineer.

TAPERED ROLLER BEARINGS

DOUBLE-ROW • TYPE TDO

TYPE TDO



Bearing Dimensions				Load Ratings							
Bore d	O.D. D	Width T	Double Outer Ring Width C	Dynamic ⁽¹⁾				Dynamic ⁽³⁾			
				C ₁₍₂₎	e	Y ₁	Y ₂	C ₉₀	C _{a90}	C ₉₀₍₂₎	K
mm in.	mm in.	mm in.	mm in.	N lbf				N lbf	N lbf	N lbf	
215.900 8.5000	287.338 11.3125	69.850 2.7500	50.800 2.0000	416000 93600	0.39	1.75	2.61	62000 13900	40900 9190	108000 24300	1.52
215.900 8.5000	355.600 14.0000	152.400 6.0000	111.125 4.3750	1390000 312000	0.33	2.04	3.04	206000 46400	117000 26200	359000 80800	1.77
215.900 8.5000	355.600 14.0000	158.750 6.2500	117.475 4.6250	1390000 312000	0.33	2.04	3.04	206000 46400	117000 26200	359000 80800	1.77
215.900 8.5000	371.475 14.6250	174.625 6.8750	136.525 5.3750	1920000 432000	0.40	1.68	2.50	286000 64300	197000 44200	498000 112000	1.45
215.900 8.5000	406.400 16.0000	195.262 7.6875	147.638 5.8125	2560000 577000	0.39	1.72	2.55	382000 85900	257000 57800	665000 149000	1.48
219.969 8.6602	287.338 11.3125	69.850 2.7500	50.800 2.0000	416000 93600	0.39	1.75	2.61	62000 13900	40900 9190	108000 24300	1.52
220.000 8.6614	340.000 13.3858	164.000 6.4567	130.000 5.1181	1730000 389000	0.43	1.57	2.34	258000 57900	190000 42700	449000 101000	1.36
220.662 8.6875	314.325 12.3750	131.762 5.1875	106.362 4.1875	1490000 335000	0.33	2.03	3.02	222000 49900	126000 28400	386000 86800	1.76
220.662 8.6875	314.325 12.3750	131.762 5.1875	106.362 4.1875	1210000 272000	0.33	2.03	3.02	180000 40500	103000 23100	314000 70500	1.76
220.662 8.6875	314.325 12.3750	131.762 5.1875	106.362 4.1875	1390000 312000	0.33	2.03	3.02	207000 46500	118000 26500	360000 80900	1.76
225.425 8.8750	355.600 14.0000	152.600 6.0000	152.600 6.0000	1390000 312000	0.33	2.04	3.04	206000 46400	117000 26200	359000 80800	1.77
225.425 8.8750	355.600 14.0000	158.750 6.2500	158.750 6.2500	1390000 312000	0.33	2.04	3.04	206000 46400	117000 26200	359000 80800	1.77
225.425 8.8750	400.050 15.7500	187.325 7.3750	136.525 5.3750	1960000 440000	0.44	1.54	2.29	291000 65500	219000 49300	507000 114000	1.33
228.397 8.9920	431.800 17.0000	196.850 7.7500	111.125 4.3750	2220000 499000	0.88	0.76	1.14	330000 74300	500000 112000	575000 129000	0.66
228.460 8.9945	431.800 17.0000	196.850 7.7500	111.125 4.3750	2220000 499000	0.88	0.76	1.14	330000 74300	500000 112000	575000 129000	0.66
228.600 9.0000	327.025 12.8750	114.300 4.5000	82.550 3.2500	972000 219000	0.41	1.66	2.47	145000 32500	101000 22700	252000 56700	1.44
228.600 9.0000	355.600 14.0000	152.400 6.0000	111.125 4.3750	1320000 297000	0.59	1.14	1.70	197000 44200	199000 44700	343000 77000	0.99

⁽¹⁾Based on 1 x 10⁶ revolutions L₁₀ life, for the ISO life-calculation method. C₁₍₂₎ is the double-row radial value.

⁽²⁾Consult your Timken engineer for instructions on use or review the Timken Engineering Manual on timken.com/catalogs.

⁽³⁾Based on 90 x 10⁶ revolutions L₁₀ life, for The Timken Company life-calculation method. C₉₀ and C_{a90} are radial and thrust values for a single row. C₉₀₍₂₎ is the double-row radial value.

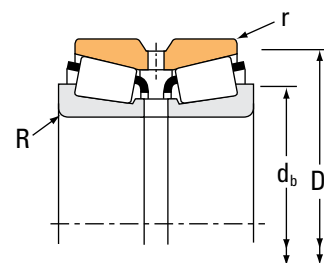
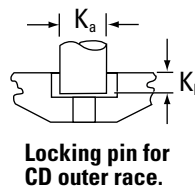
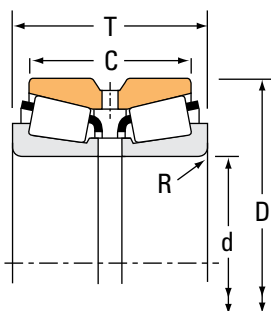
Part Number		Dimensions						Geometry Factors			Bearing Weight
Inner	Outer	Shaft		Housing		Pin		G ₁	G ₂	C _g	
		Max. Shaft Fillet Radius R ⁽⁴⁾	Backing Shoulder Dia. d _b	Max. Housing Fillet Radius r ⁽⁴⁾	Backing Shoulder Dia. D _a	K _a	K _b				
		mm in.	mm in.	mm in.	mm in.	mm in.	mm in.				kg lbs.
543085	543115D	3.5 0.14	232.0 9.13	0.8 0.03	276.0 10.87	– –	– –	608.5	232.3	0.1135	11.47 25.30
EE130851	131401CD	6.8 0.27	248.0 9.76	1.5 0.06	330.0 12.99	22.23 0.88	8.73 0.34	1162.0	167.6	0.1358	53.77 118.52
EE130851	131402D	6.8 0.27	248.0 9.76	0.8 0.03	331.8 13.06	– –	– –	1162.0	167.6	0.1358	53.62 118.19
EE420850	421462XD	1.5 0.06	236.0 9.29	1.5 0.06	334.4 13.16	– –	– –	1150.5	128.2	0.1450	71.26 157.10
EE820085	820161CD	6.4 0.25	251.0 9.88	1.5 0.06	372.1 14.65	28.58 1.13	11.91 0.47	1326.8	111.9	0.1509	106.33 234.46
543086	543115D	3.5 0.14	235.0 9.25	0.8 0.03	276.0 10.87	– –	– –	608.5	232.3	0.1135	10.71 23.61
X32044XM	NP099132	4.0 0.16	248.0 9.76	1.0 0.04	326.5 12.85	– –	– –	1207.8	127.4	0.1509	50.74 111.88
DX596094	DX198514	6.4 0.25	245.0 9.65	1.5 0.06	300.0 11.81	22.23 0.88	9.52 0.38	1149.7	141.4	0.1360	31.26 68.92
M244249	M244210CD	6.4 0.25	245.0 9.65	1.5 0.06	300.0 11.81	22.23 0.88	9.52 0.38	1149.7	141.4	0.1360	29.97 66.07
NP995051	M244210CD	6.4 0.25	245.0 9.65	1.5 0.06	300.0 11.81	22.23 0.88	9.52 0.38	1149.7	141.4	0.1360	30.09 66.30
EE130889	131401CD	6.8 0.27	255.0 10.04	1.5 0.06	330.0 12.99	22.23 0.88	8.73 0.34	1162.0	167.6	0.1358	48.69 107.38
EE130889	131402D	6.8 0.27	255.0 10.04	0.8 0.03	331.8 13.06	– –	– –	1162.0	167.6	0.1358	48.90 107.83
EE430888	431576CD	1.5 0.06	251.0 9.88	1.5 0.06	364.2 14.34	28.58 1.13	11.91 0.47	1351.2	142.8	0.1572	90.91 200.41
EE113089	113171D	6.4 0.25	274.0 10.79	3.3 0.13	397.2 15.64	– –	– –	966.7	98.1	0.1723	109.66 241.73
EE113091	113171D	6.4 0.25	274.0 10.79	3.3 0.13	397.2 15.64	– –	– –	966.7	98.1	0.1723	107.78 237.60
8573	8520CD	6.4 0.25	255.0 10.04	1.5 0.06	312.0 12.28	19.05 0.75	7.92 0.31	1050.5	172.4	0.1401	28.22 62.23
96900	96140CD	7.0 0.28	260.0 10.24	1.5 0.06	334.0 13.15	25.40 1.00	9.52 0.38	1140.0	160.6	0.1626	49.73 109.66

⁽⁴⁾These maximum fillet radii will be cleared by bearing corners.
NOTE: For spacer configuration information, contact your Timken engineer.

TAPERED ROLLER BEARINGS

DOUBLE-ROW • TYPE TDO

TYPE TDO



Bearing Dimensions				Load Ratings							
Bore d	O.D. D	Width T	Double Outer Ring Width C	Dynamic ⁽¹⁾				Dynamic ⁽³⁾			
				C ₁₍₂₎	e	Y ₁	Y ₂	C ₉₀	C _{a90}	C ₉₀₍₂₎	K
mm in.	mm in.	mm in.	mm in.	N lbf				N lbf	N lbf	N lbf	
228.600 9.0000	355.600 14.0000	152.400 6.0000	111.125 4.3750	1470000 330000	0.33	2.04	3.04	219000 49100	124000 27800	381000 85600	1.77
228.600 9.0000	355.600 14.0000	152.400 6.0000	114.300 4.5000	1660000 372000	0.47	1.43	2.12	247000 55400	200000 44900	429000 96500	1.24
228.600 9.0000	355.600 14.0000	158.750 6.2500	117.475 4.6250	1470000 330000	0.33	2.04	3.04	219000 49100	124000 27800	381000 85600	1.77
228.600 9.0000	358.775 14.1250	152.400 6.0000	117.475 4.6250	1590000 358000	0.33	2.03	3.02	237000 53300	135000 30300	413000 92800	1.76
228.600 9.0000	400.050 15.7500	187.325 7.3750	136.525 5.3750	1960000 440000	0.44	1.54	2.29	291000 65500	219000 49300	507000 114000	1.33
228.600 9.0000	425.450 16.7500	209.550 8.2500	158.750 6.2500	2960000 665000	0.33	2.03	3.02	440000 99000	251000 56400	767000 172000	1.76
228.600 9.0000	488.950 19.2500	254.000 10.0000	152.400 6.0000	3910000 879000	0.94	0.72	1.07	582000 131000	934000 210000	1010000 228000	0.62
231.775 9.1250	358.775 14.1250	152.400 6.0000	117.475 4.6250	1590000 358000	0.33	2.03	3.02	237000 53300	135000 30300	413000 92800	1.76
234.950 9.2500	311.150 12.2500	98.425 3.8750	73.025 2.8750	768000 173000	0.36	1.86	2.77	114000 25700	70900 15900	199000 44800	1.61
234.950 9.2500	327.025 12.8750	114.300 4.5000	82.550 3.2500	935000 210000	0.41	1.66	2.47	139000 31300	96900 21800	242000 54500	1.44
234.950 9.2500	355.600 14.0000	152.400 6.0000	111.125 4.3750	1320000 297000	0.59	1.14	1.70	197000 44200	199000 44700	343000 77000	0.99
234.950 9.2500	384.175 15.1250	238.125 9.3750	193.675 7.6250	3270000 734000	0.33	2.03	3.02	486000 109000	277000 62200	847000 190000	1.76
234.950 9.2500	384.175 15.1250	238.125 9.3750	193.675 7.6250	2920000 656000	0.33	2.03	3.02	434000 97600	247000 55600	756000 170000	1.76
237.330 9.3437	358.775 14.1250	152.400 6.0000	117.475 4.6250	1590000 358000	0.33	2.03	3.02	237000 53300	135000 30300	413000 92800	1.76
241.300 9.5000	327.025 12.8750	114.300 4.5000	82.550 3.2500	918000 206000	0.41	1.66	2.47	137000 30700	95200 21400	238000 53500	1.44
241.300 9.5000	349.148 13.7460	127.000 5.0000	101.600 4.0000	1150000 258000	0.35	1.91	2.85	171000 38500	103000 23300	298000 67000	1.65
241.300 9.5000	350.838 13.8125	127.000 5.0000	101.600 4.0000	1150000 258000	0.35	1.91	2.85	171000 38500	103000 23300	298000 67000	1.65

⁽¹⁾Based on 1 x 10⁶ revolutions L₁₀ life, for the ISO life-calculation method. C₁₍₂₎ is the double-row radial value.

⁽²⁾Consult your Timken engineer for instructions on use or review the Timken Engineering Manual on timken.com/catalogs.

⁽³⁾Based on 90 x 10⁶ revolutions L₁₀ life, for The Timken Company life-calculation method. C₉₀ and C_{a90} are radial and thrust values for a single row. C₉₀₍₂₎ is the double-row radial value.

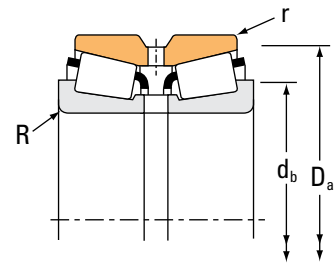
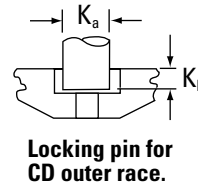
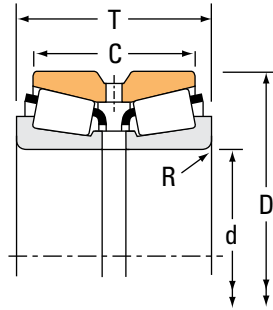
Part Number		Dimensions						Geometry Factors			Bearing Weight
Inner	Outer	Shaft		Housing		Pin		G ₁	G ₂	C _g	
		Max. Shaft Fillet Radius R ⁽⁴⁾	Backing Shoulder Dia. d _b	Max. Housing Fillet Radius r ⁽⁴⁾	Backing Shoulder Dia. D _a	K _a	K _b				
		mm in.	mm in.	mm in.	mm in.	mm in.	mm in.				kg lbs.
EE130902	131401CD	6.8 0.27	257.0 10.12	1.5 0.06	330.0 12.99	22.23 0.88	8.73 0.34	1162.0	167.6	0.1358	48.41 106.71
HM746646	HM746610CD	6.4 0.25	258.0 10.16	1.5 0.06	338.7 13.34	25.40 1.00	9.52 0.38	1185.7	149.4	0.1542	55.11 121.49
EE130902	131402D	6.8 0.27	257.0 10.12	0.8 0.03	331.8 13.06	– –	– –	1162.0	167.6	0.1358	48.76 107.48
M249732	M249710CD	3.5 0.14	256.0 10.08	1.5 0.06	343.0 13.50	25.40 1.00	8.73 0.34	1626.0	173.0	0.1526	56.43 124.42
EE430900	431576CD	10.5 0.41	271.0 10.67	1.5 0.06	364.2 14.34	28.58 1.13	11.91 0.47	1351.2	142.8	0.1572	88.47 195.04
EE700091	700168D	7.0 0.28	266.0 10.47	1.5 0.06	384.3 15.13	– –	– –	1488.7	109.7	0.1480	115.99 255.71
HH949549	HH949510D	6.4 0.25	297.0 11.69	1.5 0.06	456.0 17.95	– –	– –	1295.5	91.5	0.1931	204.99 451.94
M249734	M249710CD	6.4 0.25	263.0 10.35	1.5 0.06	343.0 13.50	25.40 1.00	8.73 0.34	1626.0	173.0	0.1526	54.98 121.22
LM446349	LM446310D	3.5 0.14	252.0 9.92	0.8 0.03	301.0 11.85	17.46 0.69	6.91 0.27	1008.4	243.6	0.1328	18.04 39.75
8574	8520CD	6.4 0.25	259.0 10.20	1.5 0.06	312.0 12.28	19.05 0.75	7.92 0.31	1010.5	166.1	0.1382	26.16 57.67
96925	96140CD	7.0 0.28	265.0 10.43	1.5 0.06	334.0 13.15	25.40 1.00	9.52 0.38	1140.0	160.6	0.1626	46.94 103.50
H247548	H247510CD	6.4 0.25	269.0 10.59	1.5 0.06	362.1 14.26	28.58 1.13	11.91 0.47	2077.6	156.6	0.1671	105.89 233.45
H247549	H247510CD	6.4 0.25	273.0 10.75	1.5 0.06	362.1 14.26	28.58 1.13	11.91 0.47	1964.4	148.4	0.1638	102.68 226.40
M249736	M249710CD	6.4 0.25	267.0 10.51	1.5 0.06	343.0 13.50	25.40 1.00	8.73 0.34	1626.0	173.0	0.1526	51.88 114.37
8578	8520CD	6.4 0.25	264.0 10.39	1.5 0.06	312.0 12.28	19.05 0.75	7.92 0.31	1050.5	172.4	0.1401	23.96 52.86
EE127095	127136CD	6.4 0.25	267.0 10.51	1.5 0.06	329.0 12.95	22.23 0.88	9.52 0.38	1178.6	164.4	0.1392	35.35 77.93
EE127095	127137D	6.4 0.25	267.0 10.51	1.5 0.06	329.0 12.95	– –	– –	1178.6	164.4	0.1392	36.87 81.29

⁽⁴⁾These maximum fillet radii will be cleared by bearing corners.
NOTE: For spacer configuration information, contact your Timken engineer.

TAPERED ROLLER BEARINGS

DOUBLE-ROW • TYPE TDO

TYPE TDO



Bearing Dimensions				Load Ratings							
Bore d	O.D. D	Width T	Double Outer Ring Width C	Dynamic ⁽¹⁾				Dynamic ⁽³⁾			
				C ₁₍₂₎	e	Y ₁	Y ₂	C ₉₀	C _{a90}	C ₉₀₍₂₎	K
mm in.	mm in.	mm in.	mm in.	N lbf				N lbf	N lbf	N lbf	
241.300 9.5000	355.498 13.9960	127.000 5.0000	101.600 4.0000	1150000 258000	0.35	1.91	2.85	171000 38500	103000 23300	298000 67000	1.65
241.300 9.5000	368.300 14.5000	120.650 4.7500	85.725 3.3750	1120000 252000	0.36	1.86	2.77	167000 37500	104000 23300	290000 65200	1.61
241.300 9.5000	393.700 15.5000	157.162 6.1875	109.538 4.3125	1760000 396000	0.40	1.68	2.50	262000 59000	181000 40600	457000 103000	1.45
241.300 9.5000	406.400 16.0000	155.575 6.1250	107.950 4.2500	1760000 396000	0.40	1.68	2.50	262000 59000	181000 40600	457000 103000	1.45
241.300 9.5000	406.400 16.0000	215.900 8.5000	184.150 7.2500	3260000 732000	0.33	2.03	3.02	485000 109000	276000 62000	844000 190000	1.76
241.300 9.5000	444.500 17.5000	209.550 8.2500	158.750 6.2500	3170000 713000	0.34	2.00	2.98	472000 106000	273000 61300	822000 185000	1.73
241.300 9.5000	488.950 19.2500	254.000 10.0000	196.850 7.7500	4220000 948000	0.31	2.16	3.21	628000 141000	336000 75600	1090000 246000	1.87
244.475 9.6250	380.898 14.9960	171.450 6.7500	127.000 5.0000	1580000 355000	0.52	1.31	1.95	235000 52900	208000 46800	410000 92100	1.13
244.475 9.6250	381.000 15.0000	171.450 6.7500	127.000 5.0000	1580000 355000	0.52	1.31	1.95	235000 52900	208000 46800	410000 92100	1.13
247.650 9.7500	368.300 14.5000	120.650 4.7500	85.725 3.3750	1120000 252000	0.36	1.86	2.77	167000 37500	104000 23300	290000 65200	1.61
247.650 9.7500	381.000 15.0000	158.750 6.2500	123.825 4.8750	2000000 450000	0.33	2.03	3.02	298000 67000	170000 38100	519000 117000	1.76
247.650 9.7500	406.400 16.0000	247.650 9.7500	203.200 8.0000	3620000 814000	0.33	2.03	3.02	539000 121000	307000 69000	939000 211000	1.76
247.650 9.7500	406.400 16.0000	247.650 9.7500	206.200 8.1181	3830000 860000	0.33	2.03	3.02	570000 128000	324000 72900	992000 223000	1.76
249.250 9.8130	380.898 14.9960	171.450 6.7500	127.000 5.0000	1580000 355000	0.52	1.31	1.95	235000 52900	208000 46800	410000 92100	1.13
249.250 9.8130	381.000 15.0000	171.450 6.7500	127.000 5.0000	1580000 355000	0.52	1.31	1.95	235000 52900	208000 46800	410000 92100	1.13
254.000 10.0000	323.850 12.7500	63.500 2.5000	50.800 2.0000	263000 59100	0.35	1.95	2.90	39200 8800	23200 5220	68200 15300	1.69
254.000 10.0000	347.662 13.6875	95.250 3.7500	69.850 2.7500	1070000 240000	0.33	2.03	3.02	159000 35700	90500 20300	277000 62200	1.76

⁽¹⁾Based on 1 x 10⁶ revolutions L₁₀ life, for the ISO life-calculation method. C₁₍₂₎ is the double-row radial value.

⁽²⁾Consult your Timken engineer for instructions on use or review the Timken Engineering Manual on timken.com/catalogs.

⁽³⁾Based on 90 x 10⁶ revolutions L₁₀ life, for The Timken Company life-calculation method. C₉₀ and C_{a90} are radial and thrust values for a single row. C₉₀₍₂₎ is the double-row radial value.

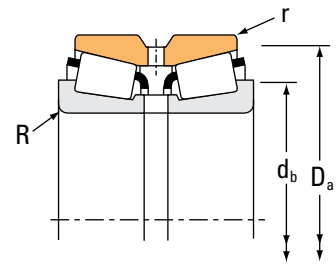
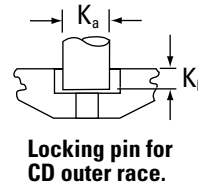
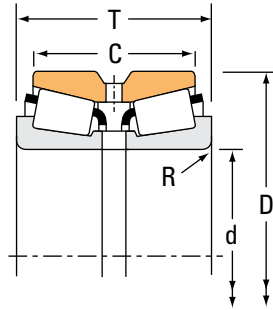
Part Number		Dimensions						Geometry Factors			Bearing Weight
Inner	Outer	Shaft		Housing		Pin		G ₁	G ₂	C _g	
		Max. Shaft Fillet Radius R ⁽⁴⁾	Backing Shoulder Dia. d _b	Max. Housing Fillet Radius r ⁽⁴⁾	Backing Shoulder Dia. D _a	K _a	K _b				
		mm in.	mm in.	mm in.	mm in.	mm in.	mm in.				kg lbs.
EE127095	127139D	6.4 0.25	267.0 10.51	1.5 0.06	329.0 12.95	– –	– –	1178.6	164.4	0.1392	38.19 84.19
EE170950	171451CD	6.4 0.25	269.0 10.59	1.5 0.06	337.0 13.27	19.05 0.75	10.34 0.41	1068.6	171.6	0.1354	40.00 88.17
EE275095	275156D	6.4 0.25	278.0 10.94	1.5 0.06	378.1 14.89	– –	– –	1451.8	201.3	0.1555	66.21 145.97
EE275095	275161D	6.4 0.25	278.0 10.94	1.5 0.06	378.1 14.89	– –	– –	1451.8	201.3	0.1555	71.84 158.39
H249148	H249111CD	6.4 0.25	273.0 10.75	1.5 0.06	385.0 15.16	28.58 1.13	11.91 0.47	1709.2	135.5	0.1556	104.28 229.92
EE923095	923176D	6.4 0.25	277.0 10.91	1.5 0.06	407.0 16.02	– –	– –	1626.7	136.5	0.1531	131.76 290.50
EE295950	295192D	6.4 0.25	285.0 11.22	1.5 0.06	450.5 17.74	– –	– –	2247.3	171.9	0.1664	214.36 472.59
EE126097	126149D	6.4 0.25	275.0 10.83	1.5 0.06	358.0 14.09	– –	– –	1321.8	168.9	0.1640	63.84 140.74
EE126097	126151CD	6.4 0.25	275.0 10.83	1.5 0.06	358.0 14.09	28.58 1.13	11.91 0.47	1321.8	168.9	0.1640	65.16 143.63
EE170975	171451CD	6.4 0.25	274.0 10.79	1.5 0.06	337.0 13.27	19.05 0.75	10.34 0.41	1068.6	171.6	0.1354	37.51 82.73
M252337	M252310CD	6.4 0.25	280.0 11.02	1.5 0.06	364.0 14.32	28.58 1.13	10.31 0.41	1839.2	226.1	0.1588	62.37 137.51
HH249949	HH249910CD	6.4 0.25	284.0 11.18	1.5 0.06	383.0 15.08	28.58 1.13	11.91 0.47	2373.9	173.3	0.1746	125.39 276.44
NP985601	NP490062	6.4 0.25	287.0 11.30	1.5 0.06	383.5 15.10	28.58 1.13	11.91 0.47	2373.9	173.3	0.1730	123.87 273.18
EE126098	126149D	6.4 0.25	279.0 10.98	1.5 0.06	358.0 14.09	– –	– –	1321.8	168.9	0.1640	62.77 138.40
EE126098	126151CD	6.4 0.25	279.0 10.98	1.5 0.06	358.0 14.09	28.58 1.13	11.91 0.47	1321.8	168.9	0.1640	62.66 138.15
29875	29820D	1.5 0.06	267.0 10.51	0.8 0.03	312.0 12.28	– –	– –	906.8	658.2	0.1567	11.05 24.34
LM249748	LM249710CD	3.5 0.14	272.0 10.71	1.5 0.06	333.0 13.11	15.86 0.62	7.13 0.28	1003.8	166.1	0.1287	22.68 50.02

⁽⁴⁾These maximum fillet radii will be cleared by bearing corners.
NOTE: For spacer configuration information, contact your Timken engineer.

TAPERED ROLLER BEARINGS

DOUBLE-ROW • TYPE TDO

TYPE TDO



Bearing Dimensions				Load Ratings							
Bore d	O.D. D	Width T	Double Outer Ring Width C	Dynamic ⁽¹⁾		Factors ⁽²⁾		Dynamic ⁽³⁾			Factors ⁽²⁾
				C ₁₍₂₎	e	Y ₁	Y ₂	C ₉₀	C _{a90}	C ₉₀₍₂₎	K
mm in.	mm in.	mm in.	mm in.	N lbf				N lbf	N lbf	N lbf	
254.000 10.0000	358.775 14.1250	152.400 6.0000	117.475 4.6250	1590000 358000	0.33	2.03	3.02	237000 53300	135000 30300	413000 92800	1.76
254.000 10.0000	365.125 14.3750	130.175 5.1250	98.425 3.8750	1180000 266000	0.37	1.80	2.69	176000 39600	113000 25400	307000 68900	1.56
254.000 10.0000	393.700 15.5000	157.162 6.1875	109.538 4.3125	1760000 396000	0.40	1.68	2.50	262000 59000	181000 40600	457000 103000	1.45
254.000 10.0000	406.400 16.0000	155.575 6.1250	107.950 4.2500	1760000 396000	0.40	1.68	2.50	262000 59000	181000 40600	457000 103000	1.45
254.000 10.0000	422.275 16.6250	173.038 6.8125	128.588 5.0625	2610000 587000	0.33	2.03	3.02	389000 87400	221000 49700	677000 152000	1.76
254.000 10.0000	422.275 16.6250	173.038 6.8125	128.588 5.0625	2690000 605000	0.33	2.03	3.02	401000 90100	228000 51300	698000 157000	1.76
254.000 10.0000	422.275 16.6250	178.592 7.0312	139.700 5.5000	2610000 587000	0.33	2.03	3.02	389000 87400	221000 49700	677000 152000	1.76
254.000 10.0000	422.275 16.6250	178.592 7.0312	139.700 5.5000	2690000 605000	0.33	2.03	3.02	401000 90100	228000 51300	698000 157000	1.76
254.000 10.0000	431.724 16.9970	173.038 6.8125	128.588 5.0625	2610000 587000	0.33	2.03	3.02	389000 87400	221000 49700	677000 152000	1.76
254.000 10.0000	431.724 16.9970	173.038 6.8125	128.588 5.0625	2690000 605000	0.33	2.03	3.02	401000 90100	228000 51300	698000 157000	1.76
254.000 10.0000	444.500 17.5000	165.100 6.5000	114.300 4.5000	2050000 460000	0.34	1.98	2.95	305000 68500	178000 40000	531000 119000	1.71
254.000 10.0000	495.300 19.5000	162.245 6.3876	120.650 4.7500	2700000 607000	0.40	1.68	2.50	402000 90300	277000 62200	700000 157000	1.45
254.000 10.0000	495.300 19.5000	168.595 6.6376	127.000 5.0000	2700000 607000	0.40	1.68	2.50	402000 90300	277000 62200	700000 157000	1.45
254.000 10.0000	533.400 21.0000	276.225 10.8750	165.100 6.5000	4670000 1050000	0.94	0.72	1.07	696000 156000	1120000 251000	1210000 272000	0.62
260.350 10.2500	365.125 14.3750	130.175 5.1250	98.425 3.8750	1180000 266000	0.37	1.80	2.69	176000 39600	113000 25400	307000 68900	1.56
260.350 10.2500	400.050 15.7500	155.575 6.1250	107.950 4.2500	1650000 372000	0.39	1.71	2.55	246000 55300	166000 37400	429000 96300	1.48
260.350 10.2500	419.100 16.5000	184.150 7.2500	136.525 5.3750	1960000 440000	0.60	1.12	1.66	291000 65500	302000 67800	507000 114000	0.97

⁽¹⁾Based on 1×10^6 revolutions L_{10} life, for the ISO life-calculation method. $C_{1(2)}$ is the double-row radial value.

⁽²⁾Consult your Timken engineer for instructions on use or review the Timken Engineering Manual on timken.com/catalogs.

⁽³⁾Based on 90×10^6 revolutions L_{10} life, for The Timken Company life-calculation method. C_{90} and C_{a90} are radial and thrust values for a single row. $C_{90(2)}$ is the double-row radial value.

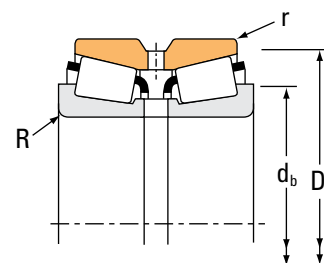
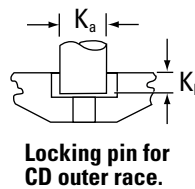
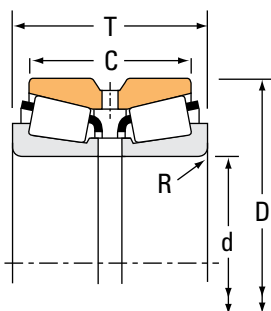
Part Number		Dimensions						Geometry Factors			Bearing Weight
Inner	Outer	Shaft		Housing		Pin		G ₁	G ₂	C _G	
		Max. Shaft Fillet Radius R ⁽⁴⁾	Backing Shoulder Dia. d _b	Max. Housing Fillet Radius r ⁽⁴⁾	Backing Shoulder Dia. D _a	K _a	K _b				
		mm in.	mm in.	mm in.	mm in.	mm in.	mm in.				kg lbs.
M249749	M249710CD	3.5 0.14	274.0 10.79	1.5 0.06	343.0 13.50	25.40 1.00	8.73 0.34	1626.0	173.0	0.1526	44.79 98.76
EE134100	134144CD	6.4 0.25	281.0 11.06	1.5 0.06	347.0 13.66	22.23 0.88	10.34 0.41	1327.7	187.2	0.1474	39.21 86.45
EE275100	275156D	6.4 0.25	287.0 11.30	1.5 0.06	378.1 14.89	– –	– –	1451.8	201.3	0.1555	60.81 134.04
EE275100	275161D	6.4 0.25	287.0 11.30	1.5 0.06	378.1 14.89	– –	– –	1451.8	201.3	0.1555	66.44 146.46
HM252343	HM252311D	6.8 0.27	287.0 11.30	1.5 0.06	400.0 15.73	– –	– –	1504.3	147.8	0.1482	84.84 187.02
HM252344	HM252311D	6.8 0.27	287.0 11.30	1.5 0.06	400.0 15.73	– –	– –	1551.8	152.3	0.1498	89.43 197.15
HM252343	HM252310CD	6.8 0.27	287.0 11.30	1.5 0.06	400.0 15.73	28.58 1.13	11.91 0.47	1504.3	147.8	0.1482	86.16 189.93
HM252344	HM252310CD	6.8 0.27	287.0 11.30	1.5 0.06	400.0 15.73	28.58 1.13	11.91 0.47	1551.8	152.3	0.1498	90.75 200.06
HM252343	HM252315D	6.8 0.27	287.0 11.30	1.5 0.06	398.3 15.68	– –	– –	1504.3	147.8	0.1482	89.83 198.03
HM252344	HM252315D	6.8 0.27	287.0 11.30	1.5 0.06	398.3 15.68	– –	– –	1551.8	152.3	0.1498	94.42 208.16
EE822100	822176D	6.4 0.25	288.0 11.34	1.5 0.06	405.4 15.96	– –	– –	1363.4	186.1	0.1442	94.11 207.47
EE941002	941951XD	6.4 0.25	301.0 11.85	1.5 0.06	463.4 18.25	– –	– –	1771.6	187.4	0.1657	132.72 292.60
EE941002	941953D	6.4 0.25	301.0 11.85	1.5 0.06	463.4 18.25	– –	– –	1771.6	187.4	0.1657	133.71 294.78
HH953749	HH953710D	6.4 0.25	328.0 12.91	1.5 0.06	495.7 19.51	– –	– –	1668.7	104.2	0.2101	266.11 586.68
EE134102	134144CD	6.4 0.25	286.0 11.26	1.5 0.06	347.0 13.66	22.23 0.88	10.34 0.41	1327.7	187.2	0.1474	36.73 80.99
EE221026	221576CD	9.7 0.38	296.0 11.65	1.5 0.06	371.5 14.63	22.23 0.88	10.31 0.41	1320.8	207.5	0.1497	59.83 131.92
EE435102	435165CD	6.4 0.25	295.0 11.61	1.5 0.06	395.1 15.56	28.58 1.13	11.91 0.47	1480.2	123.2	0.1787	88.36 194.77

⁽⁴⁾These maximum fillet radii will be cleared by bearing corners.
NOTE: For spacer configuration information, contact your Timken engineer.

TAPERED ROLLER BEARINGS

DOUBLE-ROW • TYPE TDO

TYPE TDO



Bearing Dimensions				Load Ratings							
Bore d	O.D. D	Width T	Double Outer Ring Width C	Dynamic ⁽¹⁾				Dynamic ⁽³⁾			
				C ₁₍₂₎	e	Y ₁	Y ₂	C ₉₀	C _{a90}	C ₉₀₍₂₎	K
mm in.	mm in.	mm in.	mm in.	N lbf				N lbf	N lbf	N lbf	
260.350 10.2500	419.100 16.5000	184.150 7.2500	136.525 5.3750	1960000 440000	0.60	1.12	1.66	291000 65500	302000 67800	507000 114000	0.97
260.350 10.2500	422.275 16.6250	173.038 6.8125	128.588 5.0625	2610000 587000	0.33	2.03	3.02	389000 87400	221000 49700	677000 152000	1.76
260.350 10.2500	422.275 16.6250	178.592 7.0312	139.700 5.5000	2610000 587000	0.33	2.03	3.02	389000 87400	221000 49700	677000 152000	1.76
260.350 10.2500	422.275 16.6250	178.592 7.0312	139.700 5.5000	2690000 605000	0.33	2.03	3.02	401000 90100	228000 51300	698000 157000	1.76
260.350 10.2500	422.910 16.6500	178.592 7.0312	139.700 5.5000	2610000 587000	0.33	2.03	3.02	389000 87400	221000 49700	677000 152000	1.76
260.350 10.2500	431.724 16.9970	173.038 6.8125	128.588 5.0625	2690000 605000	0.33	2.03	3.02	401000 90100	228000 51300	698000 157000	1.76
260.350 10.2500	488.950 19.2500	254.000 10.0000	196.850 7.7500	4220000 948000	0.31	2.16	3.21	628000 141000	336000 75600	1090000 246000	1.87
260.350 10.2500	488.950 19.2500	254.000 10.0000	196.850 7.7500	4220000 948000	0.31	2.16	3.21	628000 141000	336000 75600	1090000 246000	1.87
263.525 10.3750	355.600 14.0000	127.000 5.0000	101.600 4.0000	1400000 315000	0.36	1.87	2.79	209000 46900	129000 28900	363000 81600	1.62
266.700 10.5000	323.850 12.7500	63.500 2.5000	50.800 2.0000	263000 59100	0.35	1.95	2.90	39200 8800	23200 5220	68200 15300	1.69
266.700 10.5000	355.600 14.0000	127.000 5.0000	101.600 4.0000	1530000 345000	0.36	1.87	2.79	228000 51300	141000 31600	397000 89300	1.62
266.700 10.5000	393.700 15.5000	157.162 6.1875	109.538 4.3125	1760000 396000	0.40	1.68	2.50	262000 59000	181000 40600	457000 103000	1.45
266.700 10.5000	393.700 15.5000	157.162 6.1875	109.538 4.3125	1760000 396000	0.40	1.68	2.50	262000 59000	181000 40600	457000 103000	1.45
266.700 10.5000	406.400 16.0000	155.575 6.1250	107.950 4.2500	1760000 396000	0.40	1.68	2.50	262000 59000	181000 40600	457000 103000	1.45
269.875 10.6250	381.000 15.0000	158.750 6.2500	123.825 4.8750	2000000 450000	0.33	2.03	3.02	298000 67000	170000 38100	519000 117000	1.76
273.050 10.7500	393.700 15.5000	157.162 6.1875	109.538 4.3125	1760000 396000	0.40	1.68	2.50	262000 59000	181000 40600	457000 103000	1.45
273.050 10.7500	393.700 15.5000	157.162 6.1875	109.538 4.3125	1760000 396000	0.40	1.68	2.50	262000 59000	181000 40600	457000 103000	1.45

⁽¹⁾Based on 1 x 10⁶ revolutions L₁₀ life, for the ISO life-calculation method. C₁₍₂₎ is the double-row radial value.

⁽²⁾Consult your Timken engineer for instructions on use or review the Timken Engineering Manual on timken.com/catalogs.

⁽³⁾Based on 90 x 10⁶ revolutions L₁₀ life, for The Timken Company life-calculation method. C₉₀ and C_{a90} are radial and thrust values for a single row. C₉₀₍₂₎ is the double-row radial value.

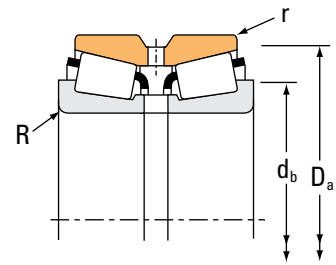
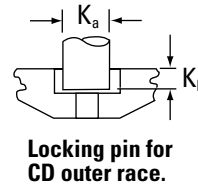
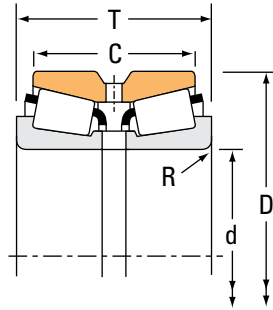
Part Number		Dimensions						Geometry Factors			Bearing Weight
Inner	Outer	Shaft		Housing		Pin		G ₁	G ₂	C _G	
		Max. Shaft Fillet Radius R ⁽⁴⁾	Backing Shoulder Dia. d _b	Max. Housing Fillet Radius r ⁽⁴⁾	Backing Shoulder Dia. D _a	K _a	K _b				
		mm in.	mm in.	mm in.	mm in.	mm in.	mm in.				kg lbs.
EE435102	435165D	6.4 0.25	295.0 11.61	1.5 0.06	395.1 15.56	–	–	1480.2	123.2	0.1787	87.66 193.23
HM252348	HM252311D	6.8 0.27	292.0 11.50	1.5 0.06	400.0 15.73	–	–	1504.3	147.8	0.1482	81.96 180.67
HM252348	HM252310CD	6.8 0.27	292.0 11.50	1.5 0.06	400.0 15.73	28.58 1.13	11.91 0.47	1504.3	147.8	0.1482	82.85 182.64
HM252349	HM252310CD	6.8 0.27	292.0 11.50	1.5 0.06	400.0 15.73	28.58 1.13	11.91 0.47	1551.8	152.3	0.1498	87.21 192.26
HM252348	HM252312D	6.8 0.27	292.0 11.50	1.5 0.06	399.5 15.73	–	–	1504.3	147.8	0.1482	83.31 183.66
HM252349	HM252315D	6.8 0.27	292.0 11.50	1.5 0.06	398.3 15.68	–	–	1551.8	152.3	0.1498	92.67 204.30
EE295102	295192D	6.4 0.25	299.0 11.77	1.5 0.06	450.5 17.74	–	–	2247.3	171.9	0.1664	198.86 438.41
EE295102	295192CD	6.4 0.25	299.0 11.77	1.5 0.06	450.5 17.74	28.58 1.13	14.30 0.56	2247.3	171.9	0.1664	198.86 438.41
LM451345	LM451310CD	3.5 0.14	283.0 11.14	1.5 0.06	342.9 13.50	22.23 0.88	8.73 0.34	1554.1	212.2	0.1536	32.93 72.62
29880	29820D	1.5 0.06	277.0 10.91	0.8 0.03	312.0 12.28	–	–	906.8	658.2	0.1567	9.04 19.93
LM451349	LM451310CD	3.5 0.14	285.0 11.22	1.5 0.06	342.9 13.50	22.23 0.88	8.73 0.34	1554.1	212.2	0.1536	31.82 70.17
EE275105	275156CD	6.4 0.25	296.0 11.65	1.5 0.06	378.5 14.90	25.40 1.00	9.52 0.38	1451.8	201.3	0.1555	55.47 122.31
EE275105	275156D	6.4 0.25	296.0 11.65	1.5 0.06	378.1 14.89	–	–	1451.8	201.3	0.1555	55.11 121.50
EE275105	275161D	6.4 0.25	296.0 11.65	1.5 0.06	378.1 14.89	–	–	1451.8	201.3	0.1555	60.74 133.92
M252349	M252310CD	6.4 0.25	296.0 11.65	1.5 0.06	364.0 14.32	28.58 1.13	10.31 0.41	1839.2	226.1	0.1588	51.96 114.53
EE275108	275156CD	6.4 0.25	301.0 11.85	1.5 0.06	378.5 14.90	25.40 1.00	9.52 0.38	1451.8	201.3	0.1555	53.10 117.05
EE275108	275156D	6.4 0.25	301.0 11.85	1.5 0.06	378.1 14.89	–	–	1451.8	201.3	0.1555	52.35 115.39

⁽⁴⁾These maximum fillet radii will be cleared by bearing corners.
NOTE: For spacer configuration information, contact your Timken engineer.

TAPERED ROLLER BEARINGS

DOUBLE-ROW • TYPE TDO

TYPE TDO



Bearing Dimensions				Load Ratings							
Bore d	O.D. D	Width T	Double Outer Ring Width C	Dynamic ⁽¹⁾				Dynamic ⁽³⁾			
				C ₁₍₂₎	e	Y ₁	Y ₂	C ₉₀	C _{a90}	C ₉₀₍₂₎	K
mm in.	mm in.	mm in.	mm in.	N lbf				N lbf	N lbf	N lbf	
273.050 10.7500	406.400 16.0000	155.575 6.1250	107.950 4.2500	1760000 396000	0.40	1.68	2.50	262000 59000	181000 40600	457000 103000	1.45
276.225 10.8750	508.000 20.0000	190.500 7.5000	127.000 5.0000	2510000 565000	0.58	1.17	1.75	374000 84100	369000 82900	651000 146000	1.01
279.400 11.0000	374.650 14.7500	104.775 4.1250	79.375 3.1250	905000 203000	0.40	1.68	2.50	135000 30300	92700 20800	235000 52700	1.45
279.400 11.0000	469.900 18.5000	200.025 7.8750	149.225 5.8750	2810000 631000	0.38	1.79	2.66	418000 94000	271000 60800	728000 164000	1.55
279.400 11.0000	488.950 19.2500	254.000 10.0000	196.850 7.7500	4220000 948000	0.31	2.16	3.21	628000 141000	336000 75600	1090000 246000	1.87
279.400 11.0000	488.950 19.2500	254.000 10.0000	196.850 7.7500	4220000 948000	0.31	2.16	3.21	628000 141000	336000 75600	1090000 246000	1.87
279.982 11.0229	380.898 14.9960	139.700 5.5000	107.950 4.2500	1260000 283000	0.43	1.56	2.33	187000 42100	138000 31100	326000 73300	1.35
280.192 11.0312	406.400 16.0000	120.650 4.7500	85.725 3.3750	1200000 270000	0.41	1.65	2.46	179000 40200	125000 28100	311000 70000	1.43
280.192 11.0312	406.400 16.0000	149.225 5.8750	117.475 4.6250	1610000 362000	0.39	1.75	2.60	240000 53900	158000 35600	417000 93800	1.51
285.750 11.2500	358.775 14.1250	76.200 3.0000	53.975 2.1250	449000 101000	0.49	1.37	2.04	66800 15000	56300 12600	116000 26200	1.19
285.750 11.2500	380.898 14.9960	139.700 5.5000	107.950 4.2500	1260000 283000	0.43	1.56	2.33	187000 42100	138000 31100	326000 73300	1.35
285.750 11.2500	469.900 18.5000	177.785 6.9994	127.000 5.0000	2630000 591000	0.29	2.31	3.44	391000 88000	196000 44000	681000 153000	2.00
285.750 11.2500	476.250 18.7500	177.785 6.9994	127.000 5.0000	2630000 591000	0.29	2.31	3.44	391000 88000	196000 44000	681000 153000	2.00
285.750 11.2500	501.650 19.7500	202.200 8.0000	120.650 4.7500	2370000 533000	0.83	0.81	1.20	353000 79400	505000 113000	615000 138000	0.70
288.925 11.3750	406.400 16.0000	165.100 6.5000	130.175 5.1250	2380000 534000	0.34	2.00	2.97	354000 79500	205000 46000	616000 138000	1.73
292.100 11.5000	469.900 18.5000	200.025 7.8750	149.225 5.8750	2810000 631000	0.38	1.79	2.66	418000 94000	271000 60800	728000 164000	1.55
292.100 11.5000	469.900 18.5000	200.025 7.8750	149.225 5.8750	3030000 681000	0.38	1.79	2.66	451000 101000	292000 65600	785000 176000	1.55

⁽¹⁾Based on 1 x 10⁶ revolutions L₁₀ life, for the ISO life-calculation method. C₁₍₂₎ is the double-row radial value.

⁽²⁾Consult your Timken engineer for instructions on use or review the Timken Engineering Manual on timken.com/catalogs.

⁽³⁾Based on 90 x 10⁶ revolutions L₁₀ life, for The Timken Company life-calculation method. C₉₀ and C_{a90} are radial and thrust values for a single row. C₉₀₍₂₎ is the double-row radial value.

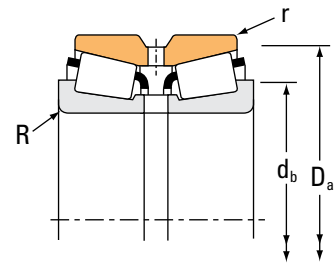
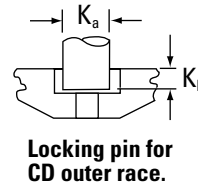
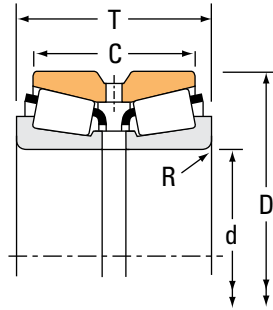
Part Number		Dimensions						Geometry Factors			Bearing Weight
Inner	Outer	Shaft		Housing		Pin		G ₁	G ₂	C _G	
		Max. Shaft Fillet Radius R ⁽⁴⁾	Backing Shoulder Dia. d _b	Max. Housing Fillet Radius r ⁽⁴⁾	Backing Shoulder Dia. D _a	K _a	K _b				
		mm in.	mm in.	mm in.	mm in.	mm in.	mm in.				kg lbs.
EE275108	275161D	6.4 0.25	301.0 11.85	1.5 0.06	378.1 14.89	– –	– –	1451.8	201.3	0.1555	57.98 127.80
HM855449	HM855419D	6.4 0.25	313.0 12.32	3.3 0.13	430.0 16.93	– –	– –	1651.5	173.3	0.1824	152.70 336.65
L555233	L555210D	3.5 0.14	300.0 11.81	1.5 0.06	362.0 14.25	– –	– –	1476.9	368.2	0.1553	27.91 61.53
EE722110	722186CD	9.7 0.38	321.0 12.64	1.5 0.06	432.9 17.04	28.58 1.13	11.91 0.47	1894.4	142.6	0.1669	121.64 268.18
EE295110	295192D	1.3 0.05	303.0 11.93	1.5 0.06	450.5 17.74	– –	– –	2247.3	171.9	0.1664	183.69 404.99
EE295110	295192CD	1.3 0.05	303.0 11.93	1.5 0.06	450.5 17.74	28.58 1.13	14.30 0.56	2247.3	171.9	0.1664	183.69 404.99
LM654642	LM654610CD	3.5 0.14	302.0 11.89	1.5 0.06	368.0 14.49	22.23 0.88	10.31 0.41	1916.4	265.6	0.1744	43.56 96.00
EE101103	101601CD	6.8 0.27	309.0 12.17	1.5 0.06	376.0 14.80	19.05 0.75	10.34 0.41	1380.2	226.7	0.1527	44.44 97.97
EE128110	128160CD	6.8 0.27	309.0 12.17	1.5 0.06	384.0 15.12	25.40 1.00	9.52 0.38	1727.7	255.2	0.1628	58.47 128.93
545112	545142CD	3.5 0.14	302.0 11.89	1.5 0.06	345.0 13.58	14.29 0.56	7.95 0.31	1015.9	545.5	0.1446	15.27 33.66
LM654649	LM654610CD	3.5 0.14	306.0 12.05	1.5 0.06	368.0 14.49	22.23 0.88	10.31 0.41	1916.4	265.6	0.1744	40.74 89.80
EE921124	921851D	9.7 0.38	325.0 12.80	1.5 0.06	440.2 17.33	– –	– –	1732.1	200.0	0.1481	103.89 229.04
EE921124	921876D	9.7 0.38	325.0 12.80	1.5 0.06	440.2 17.33	– –	– –	1732.1	200.0	0.1481	104.91 231.30
EE147112	147198D	6.4 0.25	329.0 12.95	3.3 0.13	468.1 18.43	– –	– –	1487.1	138.4	0.1954	142.84 314.94
M255449H	M255410CD	6.4 0.25	317.0 12.48	1.5 0.06	387.9 15.27	28.58 1.13	11.12 0.44	2301.3	287.6	0.1722	63.76 140.59
EE722115	722186CD	9.7 0.38	330.0 12.99	1.5 0.06	432.9 17.04	28.58 1.13	11.91 0.47	1894.4	142.6	0.1669	111.93 246.76
HM456949	HM456910CD	9.7 0.38	331.0 13.03	1.5 0.06	443.0 17.44	28.58 1.13	11.91 0.47	2134.9	153.5	0.1740	118.21 260.63

⁽⁴⁾These maximum fillet radii will be cleared by bearing corners.
NOTE: For spacer configuration information, contact your Timken engineer.

TAPERED ROLLER BEARINGS

DOUBLE-ROW • TYPE TDO

TYPE TDO



Bearing Dimensions				Load Ratings							
Bore d	O.D. D	Width T	Double Outer Ring Width C	Dynamic ⁽¹⁾				Dynamic ⁽³⁾			
				C ₁₍₂₎	e	Y ₁	Y ₂	C ₉₀	C _{a90}	C ₉₀₍₂₎	K
mm in.	mm in.	mm in.	mm in.	N lbf				N lbf	N lbf	N lbf	
292.100 11.5000	469.900 18.5000	200.025 7.8750	149.225 5.8750	3950000 887000	0.38	1.79	2.66	588000 132000	380000 85500	1020000 230000	1.55
292.100 11.5000	520.700 20.5000	228.600 9.0000	165.100 6.5000	3400000 765000	0.33	2.06	3.06	506000 114000	284000 63900	882000 198000	1.78
292.100 11.5000	558.800 22.0000	298.450 11.7500	222.250 8.7500	5390000 1210000	0.40	1.71	2.54	802000 180000	542000 122000	1400000 314000	1.48
298.450 11.7500	444.500 17.5000	146.050 5.7500	98.4250 3.8750	1540000 347000	0.38	1.79	2.66	230000 51700	149000 33400	400000 90000	1.55
299.975 11.8100	495.300 19.5000	301.625 11.8750	247.650 9.7500	5000000 1120000	0.33	2.03	3.02	744000 167000	423000 95200	1300000 291000	1.76
300.038 11.8125	422.275 16.6250	174.625 6.8750	136.525 5.3750	2260000 508000	0.34	2.00	2.99	336000 75600	194000 43600	586000 132000	1.73
300.038 11.8125	422.275 16.6250	174.625 6.8750	136.525 5.3750	2260000 508000	0.34	2.00	2.99	336000 75600	194000 43600	586000 132000	1.73
300.040 11.8126	496.000 19.5276	307.576 12.1092	253.600 9.9842	6270000 1410000	0.33	2.03	3.02	933000 210000	531000 119000	1630000 365000	1.76
304.800 12.0000	393.700 15.5000	107.950 4.2500	82.550 3.2500	1020000 229000	0.36	1.88	2.80	152000 34200	93500 21000	265000 59500	1.63
304.800 12.0000	412.750 16.2500	123.825 4.8750	92.075 3.6250	1080000 242000	0.43	1.58	2.35	160000 36000	117000 26300	279000 62700	1.37
304.800 12.0000	412.750 16.2500	158.750 6.2500	127.000 5.0000	1080000 242000	0.43	1.58	2.35	160000 36000	117000 26300	279000 62700	1.37
304.800 12.0000	438.048 17.2460	165.100 6.5000	120.650 4.7500	1560000 351000	0.42	1.62	2.42	232000 52200	165000 37200	405000 91000	1.40
304.8000 12.0000	444.5000 17.5000	146.050 5.7500	98.425 3.8750	1540000 347000	0.38	1.79	2.66	230000 51700	149000 33400	400000 90000	1.55
304.800 12.0000	444.500 17.5000	223.825 8.8120	176.200 6.9370	1540000 347000	0.38	1.79	2.66	230000 51700	149000 33400	400000 90000	1.55
304.800 12.0000	495.300 19.5000	162.245 6.3876	120.650 4.7500	2700000 607000	0.40	1.68	2.50	402000 90300	277000 62200	700000 157000	1.45
304.800 12.0000	495.300 19.5000	168.595 6.6376	127.000 5.0000	2700000 607000	0.40	1.68	2.50	402000 90300	277000 62200	700000 157000	1.45
304.800 12.0000	495.300 19.5000	196.850 7.7500	146.050 5.7500	2630000 591000	0.40	1.68	2.50	392000 88000	269000 60600	682000 153000	1.45

⁽¹⁾Based on 1×10^6 revolutions L_{10} life, for the ISO life-calculation method. $C_{1(2)}$ is the double-row radial value.

⁽²⁾Consult your Timken engineer for instructions on use or review the Timken Engineering Manual on timken.com/catalogs.

⁽³⁾Based on 90×10^6 revolutions L_{10} life, for The Timken Company life-calculation method. C_{90} and C_{a90} are radial and thrust values for a single row. $C_{90(2)}$ is the double-row radial value.

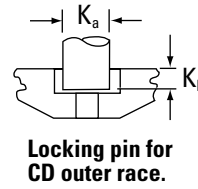
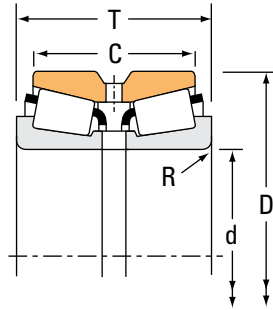
Part Number		Dimensions						Geometry Factors			Bearing Weight
Inner	Outer	Shaft		Housing		Pin		G ₁	G ₂	C _G	
		Max. Shaft Fillet Radius R ⁽⁴⁾	Backing Shoulder Dia. d _b	Max. Housing Fillet Radius r ⁽⁴⁾	Backing Shoulder Dia. D _a	K _a	K _b				
		mm in.	mm in.	mm in.	mm in.	mm in.	mm in.				kg lbs.
NP911398	NP993155	9.7 0.38	331.0 13.03	1.5 0.06	443.0 17.44	28.58 1.13	11.91 0.47	2134.9	153.5	0.1740	118.73 261.77
EE224115	224205D	6.4 0.25	331.0 13.03	1.5 0.06	468.2 18.43	– –	– –	2630.1	228.6	0.1780	192.33 424.04
EE790114	790223D	6.4 0.25	335.0 13.19	1.5 0.06	514.2 20.24	– –	– –	2663.9	170.3	0.1898	297.82 656.59
EE291175	291751CD	8.00 0.31	332.00 13.07	1.50 0.06	413.89 16.30	22.23 0.88	11.91 0.47	1579.2	244.8	0.1557	65.59 144.62
HH258248	HH258210CD	6.4 0.25	342.0 13.46	1.5 0.06	467.0 18.40	28.58 1.13	14.30 0.56	3853.2	220.0	0.2048	229.10 505.10
HM256849	HM256810D	6.4 0.25	328.0 12.91	1.5 0.06	403.0 15.88	– –	– –	2548.4	281.8	0.1779	73.00 160.96
HM256849	HM256810CD	6.4 0.25	328.0 12.91	1.5 0.06	403.0 15.88	28.58 1.13	11.91 0.47	2548.4	281.8	0.1779	73.00 160.96
JHH258247	JHH258211CD	6.4 0.25	346.0 13.62	1.5 0.06	467.0 18.39	28.58 1.13	14.30 0.56	3853.2	220.0	0.2048	234.73 517.50
L357049	L357010CD	6.4 0.25	329.0 12.95	1.5 0.06	380.0 14.96	19.05 0.75	7.95 0.31	1753.3	301.0	0.1585	29.90 65.92
EE109120	109163D	6.4 0.25	330.0 12.99	1.5 0.06	394.4 15.53	– –	– –	1520.2	251.6	0.1598	39.79 87.72
EE109120	109161D	6.4 0.25	330.0 12.99	1.5 0.06	394.4 15.53	– –	– –	1520.2	251.6	0.1598	51.53 113.61
EE129120X	129173CD	6.4 0.25	334.0 13.15	1.5 0.06	411.0 16.20	26.98 1.06	11.12 0.44	1882.6	272.9	0.1711	70.21 154.78
EE291201	291751CD	8.00 0.31	337.00 13.27	1.50 0.06	413.89 16.30	22.23 0.88	11.91 0.47	1579.2	244.8	0.1557	62.72 138.26
EE291201	291753CD	8.0 0.31	337.0 13.27	1.5 0.06	414.0 16.30	22.23 0.88	11.91 0.47	1579.2	244.8	0.1557	92.94 204.88
EE941205	941951XD	6.4 0.25	339.0 13.35	1.5 0.06	463.4 18.25	– –	– –	1771.6	187.4	0.1657	106.66 235.12
EE941205	941953D	6.4 0.25	339.0 13.35	1.5 0.06	463.4 18.25	– –	– –	1771.6	187.4	0.1657	107.65 237.30
EE724119	724196CD	16.0 0.63	359.0 14.13	1.5 0.06	458.9 18.07	28.58 1.13	12.70 0.50	2242.3	170.0	0.1800	134.62 296.78

⁽⁴⁾These maximum fillet radii will be cleared by bearing corners.
NOTE: For spacer configuration information, contact your Timken engineer.

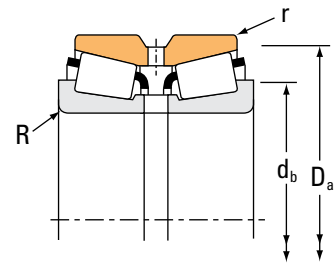
TAPERED ROLLER BEARINGS

DOUBLE-ROW • TYPE TDO

TYPE TDO



Locking pin for CD outer race.



Bearing Dimensions				Load Ratings							
Bore d	O.D. D	Width T	Double Outer Ring Width C	Dynamic ⁽¹⁾				Dynamic ⁽³⁾			
				C ₁₍₂₎	e	Y ₁	Y ₂	C ₉₀	C _{a90}	C ₉₀₍₂₎	K
mm in.	mm in.	mm in.	mm in.	N lbf				N lbf	N lbf	N lbf	
304.800 12.0000	495.300 19.5000	196.850 7.7500	146.050 5.7500	2940000 660000	0.40	1.68	2.50	437000 98300	301000 67700	762000 171000	1.45
304.800 12.0000	558.800 22.0000	298.450 11.7500	222.250 8.7500	5390000 1210000	0.40	1.71	2.54	802000 180000	542000 122000	1400000 314000	1.48
311.150 12.2500	558.800 22.0000	190.500 7.5000	111.125 4.3750	2400000 540000	0.88	0.76	1.14	358000 80400	541000 122000	623000 140000	0.66
317.5000 12.5000	444.5000 17.5000	146.050 5.7500	98.425 3.8750	1540000 347000	0.38	1.79	2.66	230000 51700	149000 33400	400000 90000	1.55
317.500 12.5000	447.675 17.6250	180.975 7.1250	146.050 5.7500	3600000 808000	0.33	2.02	3.00	535000 120000	307000 69000	932000 210000	1.74
317.500 12.5000	447.675 17.6250	180.975 7.1250	146.050 5.7500	2920000 656000	0.33	2.02	3.00	435000 97800	249000 56000	757000 170000	1.74
317.500 12.5000	447.675 17.6250	180.975 7.1250	146.050 5.7500	2920000 656000	0.33	2.02	3.00	435000 97800	249000 56000	757000 170000	1.74
317.500 12.5000	622.300 24.5000	304.800 12.0000	174.625 6.8750	5500000 1240000	0.94	0.72	1.07	819000 184000	1310000 295000	1430000 321000	0.62
329.870 12.9870	533.400 21.0000	174.625 6.8750	123.825 4.8750	3010000 676000	0.33	2.03	3.02	448000 101000	255000 57300	780000 175000	1.76
329.870 12.9870	546.100 21.5000	177.800 7.0000	152.400 6.0000	3010000 676000	0.33	2.03	3.02	448000 101000	255000 57300	780000 175000	1.76
330.200 13.0000	415.925 16.3750	100.012 3.9375	74.612 2.9375	844000 190000	0.50	1.35	2.02	126000 28300	107000 24100	219000 49200	1.17
330.200 13.0000	415.925 16.3750	100.012 3.9375	74.612 2.9375	844000 190000	0.50	1.35	2.02	126000 28300	107000 24100	219000 49200	1.17
330.200 13.0000	482.600 19.0000	133.350 5.2500	88.900 3.5000	1090000 246000	0.50	1.35	2.01	163000 36600	140000 31400	284000 63800	1.17
330.200 13.0000	482.600 19.0000	177.800 7.0000	127.000 5.0000	2180000 489000	0.39	1.73	2.57	324000 72900	217000 48700	564000 127000	1.49
330.200 13.0000	482.600 19.0000	177.800 7.0000	127.000 5.0000	2180000 489000	0.39	1.73	2.57	324000 72900	217000 48700	564000 127000	1.49
330.200 13.0000	482.600 19.0000	177.800 7.0000	127.000 5.0000	2180000 489000	0.39	1.73	2.57	324000 72900	217000 48700	564000 127000	1.49
333.375 13.1250	469.900 18.5000	190.500 7.5000	152.400 6.0000	3930000 884000	0.33	2.02	3.00	586000 132000	336000 75500	1020000 229000	1.74

⁽¹⁾Based on 1 x 10⁶ revolutions L₁₀ life, for the ISO life-calculation method. C₁₍₂₎ is the double-row radial value.

⁽²⁾Consult your Timken engineer for instructions on use or review the Timken Engineering Manual on timken.com/catalogs.

⁽³⁾Based on 90 x 10⁶ revolutions L₁₀ life, for The Timken Company life-calculation method. C₉₀ and C_{a90} are radial and thrust values for a single row. C₉₀₍₂₎ is the double-row radial value.

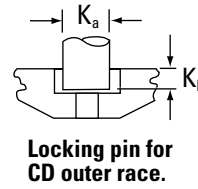
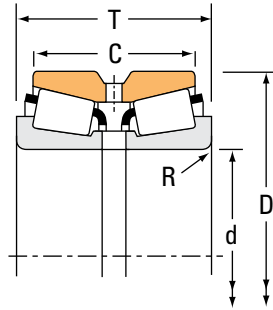
Part Number		Dimensions						Geometry Factors			Bearing Weight
Inner	Outer	Shaft		Housing		Pin		G ₁	G ₂	C _G	
		Max. Shaft Fillet Radius R ⁽⁴⁾	Backing Shoulder Dia. d _b	Max. Housing Fillet Radius r ⁽⁴⁾	Backing Shoulder Dia. D _a	K _a	K _b				
		mm in.	mm in.	mm in.	mm in.	mm in.	mm in.				kg lbs.
EE724120	724196CD	16.0 0.63	359.0 14.13	1.5 0.06	458.9 18.07	28.58 1.13	12.70 0.50	2183.9	165.7	0.1783	128.48 283.25
EE790120	790223D	1.3 0.05	335.0 13.19	1.5 0.06	514.2 20.24	– –	– –	2663.9	170.3	0.1898	284.29 626.78
EE148122	148220D	9.7 0.38	361.0 14.21	3.3 0.13	488.4 19.23	– –	– –	1639.0	153.2	0.2048	169.43 373.55
EE291250	291751CD	8.00 0.31	346.00 13.62	1.50 0.06	413.89 16.30	22.23 0.88	11.91 0.47	1579.2	244.8	0.1557	55.22 121.76
DX760136	DX307395	3.5 0.14	341.0 13.43	1.5 0.06	428.0 16.85	28.58 1.13	11.91 0.47	2944.6	303.9	0.1863	85.74 189.03
HM259049	HM259010D	3.5 0.14	341.0 13.43	1.5 0.06	427.7 16.84			2944.6	303.9	0.1863	86.01 189.64
HM259049	HM259010CD	3.5 0.14	341.0 13.43	1.5 0.06	427.7 16.84	28.58 1.13	11.91 0.47	2944.6	303.9	0.1863	86.01 189.64
H961649	H961610CD	14.3 0.56	410.0 16.14	3.3 0.13	581.6 22.90	23.80 0.94	14.30 0.56	2502.7	149.1	0.2401	371.45 818.88
EE971298	972103D	4.8 0.19	364.0 14.33	1.5 0.06	496.3 19.54	– –	– –	2433.2	282.5	0.1730	134.71 296.99
EE971298	972151D	4.8 0.19	364.0 14.33	3.3 0.13	501.9 19.76	– –	– –	2433.2	282.5	0.1730	154.99 341.68
L860048	L860010CD	12.7 0.50	367.0 14.45	1.5 0.06	402.0 15.83	17.46 0.69	8.73 0.34	1823.3	479.1	0.1774	27.53 60.72
L860049	L860010CD	3.5 0.14	349.0 13.74	1.5 0.06	402.0 15.83	17.46 0.69	8.73 0.34	1823.3	479.1	0.1774	28.77 63.45
EE161300	161901CD	7.0 0.28	367.0 14.45	1.5 0.06	455.0 17.91	22.23 0.88	11.91 0.47	1730.8	299.6	0.1741	70.80 156.09
EE526130	526191CD	6.4 0.25	360.0 14.17	1.5 0.06	454.0 17.87	28.58 1.13	11.91 0.47	2283.3	287.2	0.1790	92.44 203.80
EE526130	526191D	6.4 0.25	360.0 14.17	1.5 0.06	454.0 17.87	– –	– –	2283.3	287.2	0.1790	92.97 204.96
EE526132	526191CD	3.3 0.13	354.0 13.94	1.5 0.06	454.0 17.87	28.58 1.13	11.91 0.47	2283.3	287.2	0.1790	92.46 203.85
DX135509	DX371163	6.4 0.25	363.0 14.29	1.5 0.06	449.0 17.69	28.58 1.13	11.91 0.47	3306.8	324.3	0.1935	95.33 210.17

⁽⁴⁾These maximum fillet radii will be cleared by bearing corners.
NOTE: For spacer configuration information, contact your Timken engineer.

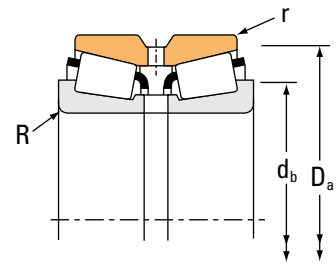
TAPERED ROLLER BEARINGS

DOUBLE-ROW • TYPE TDO

TYPE TDO



Locking pin for CD outer race.



Bearing Dimensions				Load Ratings							
Bore d	O.D. D	Width T	Double Outer Ring Width C	Dynamic ⁽¹⁾				Dynamic ⁽³⁾			
				C ₁₍₂₎	e	Y ₁	Y ₂	C ₉₀	C _{a90}	C ₉₀₍₂₎	K
mm in.	mm in.	mm in.	mm in.	N lbf				N lbf	N lbf	N lbf	
333.375 13.1250	469.900 18.5000	190.500 7.5000	152.400 6.0000	2780000 626000	0.33	2.02	3.00	415000 93200	238000 53400	722000 162000	1.74
333.375 13.1250	469.900 18.5000	190.500 7.5000	152.400 6.0000	2940000 661000	0.33	2.02	3.00	438000 98500	251000 56400	763000 171000	1.74
339.949 13.3838	579.948 22.8326	305.000 12.0079	241.000 9.4882	5890000 1320000	0.33	2.03	3.02	876000 197000	499000 112000	1530000 343000	1.76
339.949 13.3838	589.948 23.2263	340.000 13.3859	278.000 10.9449	6800000 1530000	0.33	2.03	3.02	1010000 227000	576000 130000	1760000 396000	1.76
342.900 13.5000	457.098 17.9960	142.875 5.6250	101.600 4.0000	1430000 322000	0.71	0.95	1.41	213000 48000	260000 58500	371000 83500	0.82
342.900 13.5000	457.098 17.9960	142.875 5.6250	101.600 4.0000	1430000 322000	0.71	0.95	1.41	213000 48000	260000 58500	371000 83500	0.82
342.900 13.5000	533.400 21.0000	165.100 6.5000	114.300 4.5000	3010000 676000	0.33	2.03	3.02	448000 101000	255000 57300	780000 175000	1.76
342.900 13.5000	533.400 21.0000	174.625 6.8750	114.300 4.5000	3010000 676000	0.33	2.03	3.02	448000 101000	255000 57300	780000 175000	1.76
342.900 13.5000	546.100 21.5000	177.800 7.0000	114.300 4.5000	3010000 676000	0.33	2.03	3.02	448000 101000	255000 57300	780000 175000	1.76
346.075 13.6250	482.600 19.0000	133.350 5.2500	88.900 3.5000	1090000 246000	0.50	1.35	2.01	163000 36600	140000 31400	284000 63800	1.17
346.075 13.6250	488.950 19.2500	200.025 7.8750	158.750 6.2500	3250000 730000	0.33	2.02	3.00	483000 109000	277000 62300	842000 189000	1.74
346.075 13.6250	488.950 19.2500	200.025 7.8750	158.750 6.2500	3010000 676000	0.33	2.02	3.00	448000 101000	257000 57700	780000 175000	1.74
349.250 13.7500	514.350 20.2500	193.675 7.6250	152.400 6.0000	2350000 529000	0.37	1.84	2.74	350000 78700	220000 49500	610000 137000	1.59
354.012 13.9375	482.600 19.0000	133.350 5.2500	88.900 3.5000	954000 214000	0.50	1.35	2.01	142000 31900	122000 27400	247000 55600	1.17
355.600 14.0000	444.500 17.5000	136.525 5.3750	111.125 4.3750	1280000 287000	0.31	2.20	3.27	190000 42700	100000 22500	331000 74400	1.90
355.600 14.0000	482.600 19.0000	133.350 5.2500	88.900 3.5000	1090000 246000	0.50	1.35	2.01	163000 36600	140000 31400	284000 63800	1.17
355.600 14.0000	501.650 19.7500	155.575 6.1250	107.950 4.2500	1830000 412000	0.44	1.53	2.28	273000 61300	206000 46200	475000 107000	1.33

⁽¹⁾Based on 1 x 10⁶ revolutions L₁₀ life, for the ISO life-calculation method. C₁₍₂₎ is the double-row radial value.

⁽²⁾Consult your Timken engineer for instructions on use or review the Timken Engineering Manual on timken.com/catalogs.

⁽³⁾Based on 90 x 10⁶ revolutions L₁₀ life, for The Timken Company life-calculation method. C₉₀ and C_{a90} are radial and thrust values for a single row. C₉₀₍₂₎ is the double-row radial value.

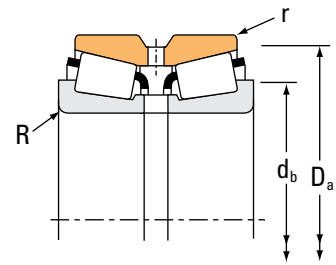
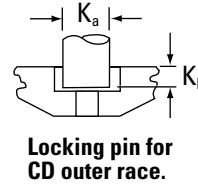
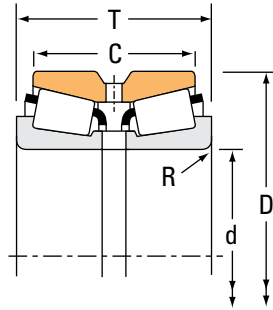
Part Number		Dimensions						Geometry Factors			Bearing Weight
Inner	Outer	Shaft		Housing		Pin		G ₁	G ₂	C _g	
		Max. Shaft Fillet Radius R ⁽⁴⁾	Backing Shoulder Dia. d _b	Max. Housing Fillet Radius r ⁽⁴⁾	Backing Shoulder Dia. D _a	K _a	K _b				
		mm in.	mm in.	mm in.	mm in.	mm in.	mm in.				kg lbs.
HM261049	HM261010CD	6.4 0.25	363.0 14.29	1.5 0.06	449.5 17.70	28.58 1.13	11.91 0.47	3306.8	324.3	0.1935	99.90 220.23
HM261049H	HM261010CD	6.4 0.25	363.0 14.29	1.5 0.06	449.5 17.70	28.58 1.13	11.91 0.47	3045.1	299.8	0.1880	95.90 211.44
H263949	H263910D	14.0 0.55	396.0 15.59	3.5 0.14	540.0 21.27	– –	– –	4370.9	231.9	0.2126	318.99 703.30
HH264149	HH264110CD	14.0 0.55	402.0 15.83	3.5 0.14	552.0 21.73	28.58 1.13	15.09 0.59	5002.5	237.7	0.2228	381.14 840.26
LM961548	LM961511D	3.3 0.13	367.0 14.45	1.5 0.06	443.1 17.44	– –	– –	2281.5	300.4	0.2146	59.77 131.78
LM961548	LM961511CD	3.3 0.13	367.0 14.45	1.5 0.06	443.1 17.44	22.23 0.88	11.12 0.44	2281.5	300.4	0.2146	59.77 131.78
EE971354	972102CD	4.8 0.19	373.0 14.69	1.5 0.06	496.3 19.54	22.23 0.88	12.70 0.50	2433.2	282.5	0.1730	120.66 266.02
EE971354	972103D	4.8 0.19	373.0 14.69	1.5 0.06	496.3 19.54	– –	– –	2433.2	282.5	0.1730	121.86 268.68
EE971354	972151D	4.8 0.19	373.0 14.69	3.3 0.13	501.9 19.76	– –	– –	2433.2	282.5	0.1730	141.87 312.78
EE161363	161901CD	7.0 0.28	379.0 14.92	1.5 0.06	455.0 17.91	22.23 0.88	11.91 0.47	1730.8	299.6	0.1741	61.90 136.45
HM262748	HM262710CD	6.4 0.25	377.0 14.84	1.5 0.06	467.0 18.39	28.58 1.13	11.91 0.47	3430.8	322.6	0.1956	110.40 243.37
HM262749	HM262710CD	6.4 0.25	377.0 14.84	1.5 0.06	467.0 18.39	28.58 1.13	11.91 0.47	3646.2	341.8	0.1999	113.26 249.69
EE333137	333203CD	6.4 0.25	382.0 15.04	1.5 0.06	478.3 18.83	28.58 1.13	11.91 0.47	3037.5	334.7	0.1928	123.41 272.08
EE161394	161901CD	7.0 0.28	385.0 15.16	1.5 0.06	455.0 17.91	22.23 0.88	11.91 0.47	1730.8	299.6	0.1741	58.33 128.62
L163149	L163110CD	3.5 0.14	374.0 14.72	1.5 0.06	430.0 16.93	22.23 0.88	9.52 0.38	3207.7	621.3	0.1838	44.54 98.21
EE161400	161901CD	7.0 0.28	386.0 15.20	1.5 0.06	455.0 17.91	22.23 0.88	11.91 0.47	1730.8	299.6	0.1741	57.40 126.53
EE231400	231976CD	6.4 0.25	388.0 15.28	1.5 0.06	481.0 18.94	22.23 0.88	11.91 0.47	2386.0	366.8	0.1874	85.25 181.34

⁽⁴⁾These maximum fillet radii will be cleared by bearing corners.
NOTE: For spacer configuration information, contact your Timken engineer.

TAPERED ROLLER BEARINGS

DOUBLE-ROW • TYPE TDO

TYPE TDO



Bearing Dimensions				Load Ratings							
Bore d	O.D. D	Width T	Double Outer Ring Width C	Dynamic ⁽¹⁾				Dynamic ⁽³⁾			
				C ₁₍₂₎	e	Y ₁	Y ₂	C ₉₀	C _{a90}	C ₉₀₍₂₎	K
mm in.	mm in.	mm in.	mm in.	N lbf				N lbf	N lbf	N lbf	
355.600 14.0000	514.350 20.2500	155.575 6.1250	107.950 4.2500	1830000 412000	0.44	1.53	2.28	273000 61300	206000 46200	475000 107000	1.33
355.600 14.0000	514.350 20.2500	193.675 7.6250	152.400 6.0000	2350000 529000	0.37	1.84	2.74	350000 78700	220000 49500	610000 137000	1.59
368.249 14.4980	523.875 20.6250	214.312 8.4375	169.862 6.6875	4870000 1100000	0.33	2.03	3.02	725000 163000	413000 92900	1260000 284000	1.76
368.249 14.4980	523.875 20.6250	214.312 8.4375	169.862 6.6875	3960000 890000	0.33	2.03	3.02	589000 132000	335000 75400	1030000 231000	1.76
368.300 14.5000	596.900 23.5000	203.200 8.0000	133.350 5.2500	3090000 694000	0.41	1.63	2.42	460000 103000	326000 73400	801000 180000	1.41
371.475 14.6250	501.650 19.7500	155.575 6.1250	107.950 4.2500	1830000 412000	0.44	1.53	2.28	273000 61300	206000 46200	475000 107000	1.33
371.475 14.6250	514.350 20.2500	155.575 6.1250	107.950 4.2500	1830000 412000	0.44	1.53	2.28	273000 61300	206000 46200	475000 107000	1.33
377.825 14.8750	508.000 20.0000	139.700 5.5000	88.900 3.5000	1320000 296000	0.53	1.27	1.89	196000 44000	179000 40200	341000 76600	1.10
379.948 14.9586	659.925 25.9813	380.000 14.9606	309.997 12.2046	8320000 1870000	0.33	2.03	3.02	1240000 278000	705000 159000	2160000 485000	1.76
380.000 14.9606	620.000 24.4094	241.000 9.4882	172.000 6.7717	4870000 1090000	0.46	1.47	2.19	725000 163000	569000 128000	1260000 284000	1.27
381.000 15.0000	508.000 20.0000	139.700 5.5000	88.900 3.5000	1320000 296000	0.53	1.27	1.89	196000 44000	179000 40200	341000 76600	1.10
381.000 15.0000	546.100 21.5000	222.250 8.7500	177.800 7.0000	4860000 1090000	0.33	2.03	3.02	723000 163000	412000 92600	1260000 283000	1.76
381.000 15.0000	546.100 21.5000	222.250 8.7500	177.800 7.0000	3950000 887000	0.33	2.03	3.02	588000 132000	335000 75200	1020000 230000	1.76
381.000 15.0000	546.100 21.5000	222.250 8.7500	177.800 7.0000	4290000 963000	0.33	2.03	3.02	638000 143000	363000 81700	1110000 250000	1.76
381.000 15.0000	590.550 23.2500	244.475 9.6250	193.675 7.6250	4970000 1120000	0.33	2.03	3.02	740000 166000	421000 94800	1290000 290000	1.76
381.000 15.0000	590.550 23.2500	244.475 9.6250	193.675 7.6250	4970000 1120000	0.33	2.03	3.02	740000 166000	421000 94800	1290000 290000	1.76
384.175 15.1250	546.100 21.5000	222.250 8.7500	177.800 7.0000	3950000 887000	0.33	2.03	3.02	588000 132000	335000 75200	1020000 230000	1.76

⁽¹⁾Based on 1 x 10⁶ revolutions L₁₀ life, for the ISO life-calculation method. C₁₍₂₎ is the double-row radial value.

⁽²⁾Consult your Timken engineer for instructions on use or review the Timken Engineering Manual on timken.com/catalogs.

⁽³⁾Based on 90 x 10⁶ revolutions L₁₀ life, for The Timken Company life-calculation method. C₉₀ and C_{a90} are radial and thrust values for a single row. C₉₀₍₂₎ is the double-row radial value.

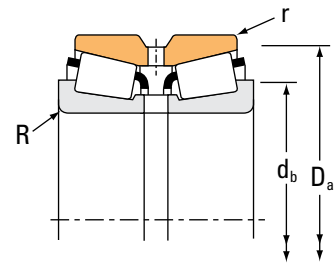
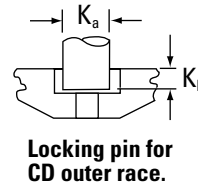
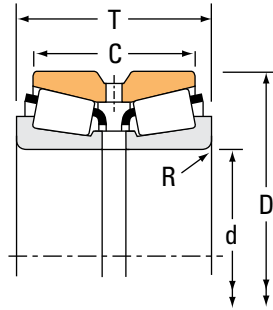
Part Number		Dimensions						Geometry Factors			Bearing Weight
Inner	Outer	Shaft		Housing		Pin		G ₁	G ₂	C _g	
		Max. Shaft Fillet Radius R ⁽⁴⁾	Backing Shoulder Dia. d _b	Max. Housing Fillet Radius r ⁽⁴⁾	Backing Shoulder Dia. D _a	K _a	K _b				
		mm in.	mm in.	mm in.	mm in.	mm in.	mm in.				kg lbs.
EE231400	232026D	6.4 0.25	388.0 15.28	1.5 0.06	481.1 18.94	– –	– –	2386.0	366.8	0.1874	89.44 197.21
EE333140	333203CD	6.4 0.25	387.0 15.24	1.5 0.06	478.3 18.83	28.58 1.13	11.91 0.47	3037.5	334.7	0.1928	117.34 258.71
DX418857	DX748779	6.4 0.25	400.0 15.75	1.5 0.06	499.0 19.63	28.58 1.13	11.91 0.47	4297.3	412.9	0.2106	141.29 311.48
HM265049	HM265010CD	6.4 0.25	400.0 15.75	1.5 0.06	499.0 19.65	28.58 1.13	11.91 0.47	4297.3	412.9	0.2106	143.00 315.22
EE181453	182351D	9.7 0.38	415.0 16.34	2.3 0.09	551.6 21.72	– –	– –	2961.8	271.9	0.1984	194.15 428.02
EE231462	231976CD	6.4 0.25	400.0 15.75	1.5 0.06	481.0 18.94	22.23 0.88	11.91 0.47	2386.0	366.8	0.1874	71.79 158.27
EE231462	232026D	6.4 0.25	400.0 15.75	1.5 0.06	481.1 18.94	– –	– –	2386.0	366.8	0.1874	79.98 176.33
EE192148	192201CD	6.4 0.25	408.0 16.06	1.5 0.06	482.0 18.98	19.05 0.75	10.34 0.41	2288.0	398.1	0.1951	67.31 148.42
HH267648	HH267610D	14.0 0.55	423.9 16.69	3.5 0.14	616.0 24.25	– –	– –	6505.2	275.8	0.2430	533.08 1175.27
NP262883	NP789786	6.0 0.24	423.0 16.65	3.0 0.12	583.5 22.97	28.58 1.13	15.09 0.59	3473.0	238.6	0.2168	257.50 567.36
EE192150	192201CD	6.4 0.25	410.0 16.14	1.5 0.06	482.0 18.98	19.05 0.75	10.34 0.41	2288.0	398.1	0.1951	65.35 144.10
DX355312	DX295661	6.4 0.25	415.0 16.34	1.5 0.06	520.0 20.47	28.58 1.13	11.91 0.47	4383.4	278.7	0.2116	156.78 345.62
HM266446	HM266410CD	6.4 0.25	415.0 16.34	1.5 0.06	520.0 20.47	28.58 1.13	11.91 0.47	4383.4	278.7	0.2116	156.78 345.62
HM266447	HM266410CD	6.4 0.25	415.0 16.34	1.5 0.06	520.0 20.47	28.58 1.13	11.91 0.47	4760.1	301.5	0.2178	163.26 359.89
M268730	M268710D	6.4 0.25	425.0 16.73	1.5 0.06	562.0 22.13	– –	– –	5754.9	420.9	0.2319	245.77 541.82
M268730	M268710CD	6.4 0.25	425.0 16.73	1.5 0.06	562.0 22.13	28.58 1.13	14.30 0.56	5754.9	420.9	0.2319	245.77 541.82
HM266448	HM266410CD	6.4 0.25	417.0 16.42	1.5 0.06	520.0 20.47	28.58 1.13	11.91 0.47	4383.4	278.7	0.2116	153.74 338.94

⁽⁴⁾These maximum fillet radii will be cleared by bearing corners.
NOTE: For spacer configuration information, contact your Timken engineer.

TAPERED ROLLER BEARINGS

DOUBLE-ROW • TYPE TDO

TYPE TDO



Bearing Dimensions				Load Ratings							
Bore d	O.D. D	Width T	Double Outer Ring Width C	Dynamic ⁽¹⁾				Dynamic ⁽³⁾			
				C ₁₍₂₎	e	Y ₁	Y ₂	C ₉₀	C _{a90}	C ₉₀₍₂₎	K
mm in.	mm in.	mm in.	mm in.	N lbf				N lbf	N lbf	N lbf	
384.175 15.1250	546.100 21.5000	222.250 8.7500	177.800 7.0000	4290000 963000	0.33	2.03	3.02	638000 143000	363000 81700	1110000 250000	1.76
385.762 15.1875	514.350 20.2500	177.800 7.0000	139.700 5.5000	2360000 530000	0.42	1.61	2.40	351000 78900	251000 56500	611000 137000	1.40
385.762 15.1875	514.350 20.2500	177.800 7.0000	139.700 5.5000	2360000 530000	0.42	1.61	2.40	351000 78900	251000 56500	611000 137000	1.40
387.248 15.2460	546.100 21.5000	185.738 7.3125	147.638 5.8125	3250000 731000	0.42	1.62	2.41	484000 109000	346000 77800	843000 190000	1.40
393.700 15.5000	539.750 21.2500	142.875 5.6250	101.600 4.0000	1890000 425000	0.48	1.42	2.11	282000 63300	230000 51600	490000 110000	1.23
393.700 15.5000	546.100 21.5000	158.750 6.2500	117.475 4.6250	1890000 425000	0.48	1.42	2.11	282000 63300	230000 51600	490000 110000	1.23
393.700 15.5000	558.800 22.0000	146.050 5.7500	104.775 4.1250	1890000 425000	0.48	1.42	2.11	282000 63300	230000 51600	490000 110000	1.23
396.875 15.6250	539.750 21.2500	142.875 5.6250	101.600 4.0000	1890000 425000	0.48	1.42	2.11	282000 63300	230000 51600	490000 110000	1.23
396.875 15.6250	546.100 21.5000	158.750 6.2500	117.475 4.6250	1890000 425000	0.48	1.42	2.11	282000 63300	230000 51600	490000 110000	1.23
396.875 15.6250	558.800 22.0000	146.050 5.7500	104.775 4.1250	1890000 425000	0.48	1.42	2.11	282000 63300	230000 51600	490000 110000	1.23
406.400 16.0000	539.750 21.2500	142.875 5.6250	101.600 4.0000	1890000 425000	0.48	1.42	2.11	282000 63300	230000 51600	490000 110000	1.23
406.400 16.0000	546.100 21.5000	158.750 6.2500	117.475 4.6250	1890000 425000	0.48	1.42	2.11	282000 63300	230000 51600	490000 110000	1.23
406.400 16.0000	546.100 21.5000	185.738 7.3125	147.638 5.8125	3250000 731000	0.42	1.62	2.41	484000 109000	346000 77800	843000 190000	1.40
406.400 16.0000	558.800 22.0000	146.050 5.7500	104.775 4.1250	1890000 425000	0.48	1.42	2.11	282000 63300	230000 51600	490000 110000	1.23
406.400 16.0000	574.675 22.6250	157.162 6.1875	106.362 4.1875	1930000 434000	0.50	1.36	2.02	287000 64600	245000 55000	500000 112000	1.17
406.400 16.0000	609.524 23.9970	177.800 7.0000	133.350 5.2500	2990000 673000	0.35	1.94	2.89	446000 100000	265000 59600	776000 175000	1.68
406.400 16.0000	609.600 24.0000	187.325 7.3750	123.825 4.8750	3210000 721000	0.38	1.76	2.62	477000 107000	313000 70400	831000 187000	1.52

⁽¹⁾Based on 1×10^6 revolutions L_{10} life, for the ISO life-calculation method. $C_{1(2)}$ is the double-row radial value.

⁽²⁾Consult your Timken engineer for instructions on use or review the Timken Engineering Manual on timken.com/catalogs.

⁽³⁾Based on 90×10^6 revolutions L_{10} life, for The Timken Company life-calculation method. C_{90} and C_{a90} are radial and thrust values for a single row. $C_{90(2)}$ is the double-row radial value.

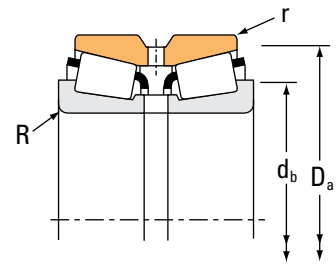
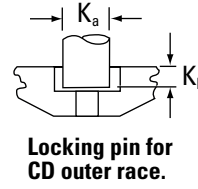
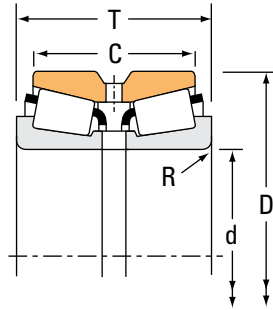
Part Number		Dimensions						Geometry Factors			Bearing Weight
Inner	Outer	Shaft		Housing		Pin		G ₁	G ₂	C _g	
		Max. Shaft Fillet Radius R ⁽⁴⁾	Backing Shoulder Dia. d _b	Max. Housing Fillet Radius r ⁽⁴⁾	Backing Shoulder Dia. D _a	K _a	K _b				
		mm in.	mm in.	mm in.	mm in.	mm in.	mm in.				kg lbs.
HM266449	HM266410CD	6.4 0.25	417.0 16.42	1.5 0.06	520.0 20.47	28.58 1.13	11.91 0.47	4760.1	301.5	0.2178	160.48 353.79
LM665949	LM665910CD	6.4 0.25	415.0 16.34	1.5 0.06	495.0 19.49	28.58 1.13	12.70 0.50	3743.4	480.0	0.2155	94.11 207.47
LM665949A	LM665910CD	15.0 0.59	433.0 17.05	1.5 0.06	495.0 19.49	28.58 1.13	12.70 0.50	3743.4	480.0	0.2155	91.89 202.57
M667935	M667911D	6.4 0.25	424.0 16.69	1.5 0.06	526.7 20.74	– –	– –	4639.7	498.9	0.2316	137.90 304.03
EE234154	234213CD	6.4 0.25	426.0 16.77	1.5 0.06	515.6 20.30	22.23 0.88	12.70 0.50	2782.9	448.6	0.2018	84.08 185.38
EE234154	234216D	6.4 0.25	426.0 16.77	1.5 0.06	515.6 20.30	– –	– –	2782.9	448.6	0.2018	96.46 212.66
EE234154	234221D	6.4 0.25	426.0 16.77	1.5 0.06	515.6 20.30	– –	– –	2782.9	448.6	0.2018	99.60 219.59
EE234156	234213CD	6.4 0.25	428.0 16.85	1.5 0.06	515.6 20.30	22.23 0.88	12.70 0.50	2782.9	448.6	0.2018	82.08 180.94
EE234156	234216D	6.4 0.25	428.0 16.85	1.5 0.06	515.6 20.30	– –	– –	2782.9	448.6	0.2018	94.09 207.42
EE234156	234221D	6.4 0.25	428.0 16.85	1.5 0.06	515.6 20.30	– –	– –	2782.9	448.6	0.2018	93.63 206.41
EE234160	234213CD	6.4 0.25	435.0 17.13	1.5 0.06	515.6 20.30	22.23 0.88	12.70 0.50	2782.9	448.6	0.2018	75.55 166.56
EE234160	234216D	6.4 0.25	435.0 17.13	1.5 0.06	515.6 20.30	– –	– –	2782.9	448.6	0.2018	82.56 182.02
M667944	M667911D	6.4 0.25	438.0 17.24	1.5 0.06	526.7 20.74	– –	– –	4639.7	498.9	0.2316	118.91 262.18
EE234160	234221D	6.4 0.25	435.0 17.13	1.5 0.06	515.6 20.30	– –	– –	2782.9	448.6	0.2018	88.09 194.20
EE285160	285228D	6.8 0.27	442.0 17.40	1.5 0.06	534.0 21.02	– –	– –	3036.6	478.1	0.2103	111.45 245.70
EE736160	736239D	8.0 0.31	449.0 17.68	1.5 0.06	576.1 22.68	– –	– –	4176.8	536.6	0.2096	167.71 369.77
EE911600	912401D	6.8 0.27	443.0 17.44	1.5 0.06	569.0 22.40	– –	– –	3251.1	349.1	0.1990	162.55 358.39

⁽⁴⁾These maximum fillet radii will be cleared by bearing corners.
NOTE: For spacer configuration information, contact your Timken engineer.

TAPERED ROLLER BEARINGS

DOUBLE-ROW • TYPE TDO

TYPE TDO



Bearing Dimensions				Load Ratings							
Bore d	O.D. D	Width T	Double Outer Ring Width C	Dynamic ⁽¹⁾				Dynamic ⁽³⁾			
				C ₁₍₂₎	e	Y ₁	Y ₂	C ₉₀	C _{a90}	C ₉₀₍₂₎	K
mm in.	mm in.	mm in.	mm in.	N lbf				N lbf	N lbf	N lbf	
406.400 16.0000	673.100 26.5000	192.639 7.5842	127.000 5.0000	3540000 797000	0.40	1.68	2.50	528000 119000	363000 81700	919000 207000	1.45
406.400 16.0000	762.000 30.0000	368.300 14.5000	222.250 8.7500	7280000 1640000	0.94	0.72	1.07	1080000 244000	1740000 391000	1890000 425000	0.62
409.575 16.1250	574.675 22.6250	157.162 6.1875	106.362 4.1875	1930000 434000	0.50	1.36	2.02	287000 64600	245000 55000	500000 112000	1.17
409.575 16.1250	635.000 25.0000	257.175 10.1250	206.375 8.1250	5700000 1280000	0.33	2.03	3.02	849000 191000	484000 109000	1480000 332000	1.76
411.162 16.1875	609.600 24.0000	187.325 7.3750	123.825 4.8750	3210000 721000	0.38	1.76	2.62	477000 107000	313000 70400	831000 187000	1.52
415.925 16.3750	590.550 23.2500	244.475 9.6250	193.675 7.6250	4970000 1120000	0.33	2.03	3.02	740000 166000	421000 94800	1290000 290000	1.76
415.925 16.3750	590.550 23.2500	244.475 9.6250	387.350 15.2500	4970000 1120000	0.33	2.03	3.02	740000 166000	421000 94800	1290000 290000	1.76
425.450 16.7500	685.698 26.9960	311.150 12.2500	234.950 9.2500	5450000 1230000	0.40	1.68	2.50	812000 183000	559000 126000	1410000 318000	1.45
430.212 16.9375	603.250 23.7500	153.289 6.0350	98.425 3.8750	1960000 441000	0.52	1.29	1.92	292000 65700	262000 59000	509000 114000	1.11
430.212 16.9375	603.250 23.7500	159.639 6.2850	104.775 4.1250	1960000 441000	0.52	1.29	1.92	292000 65700	262000 59000	509000 114000	1.11
431.800 17.0000	571.500 22.5000	155.575 6.1250	111.125 4.3750	2140000 481000	0.55	1.24	1.84	319000 71700	298000 67000	555000 125000	1.07
431.800 17.0000	571.500 22.5000	192.090 7.5626	146.050 5.7500	3320000 747000	0.44	1.54	2.29	495000 111000	371000 83500	862000 194000	1.33
431.800 17.0000	603.250 23.7500	153.289 6.0350	98.425 3.8750	1960000 441000	0.52	1.29	1.92	292000 65700	262000 59000	509000 114000	1.11
431.800 17.0000	603.250 23.7500	159.639 6.2850	104.775 4.1250	1960000 441000	0.52	1.29	1.92	292000 65700	262000 59000	509000 114000	1.11
431.800 17.0000	673.100 26.5000	192.639 7.5842	127.000 5.0000	3540000 797000	0.40	1.68	2.50	528000 119000	363000 81700	919000 207000	1.45
431.800 17.0000	673.100 26.5000	192.639 7.5842	127.000 5.0000	3540000 797000	0.40	1.68	2.50	528000 119000	363000 81700	919000 207000	1.45
431.902 17.0040	685.698 26.9960	365.125 14.3750	295.275 11.6250	8080000 1820000	0.32	2.08	3.09	1200000 270000	669000 150000	2090000 471000	1.80

⁽¹⁾Based on 1 x 10⁶ revolutions L₁₀ life, for the ISO life-calculation method. C₁₍₂₎ is the double-row radial value.

⁽²⁾Consult your Timken engineer for instructions on use or review the Timken Engineering Manual on timken.com/catalogs.

⁽³⁾Based on 90 x 10⁶ revolutions L₁₀ life, for The Timken Company life-calculation method. C₉₀ and C_{a90} are radial and thrust values for a single row. C₉₀₍₂₎ is the double-row radial value.

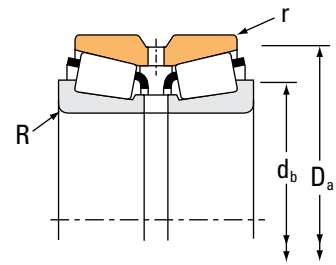
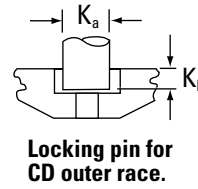
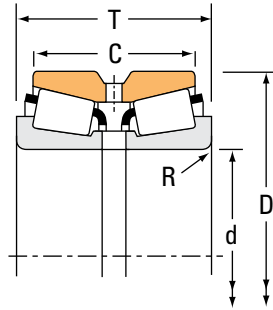
Part Number		Dimensions						Geometry Factors			Bearing Weight
Inner	Outer	Shaft		Housing		Pin		G ₁	G ₂	C _G	
		Max. Shaft Fillet Radius R ⁽⁴⁾	Backing Shoulder Dia. d _b	Max. Housing Fillet Radius r ⁽⁴⁾	Backing Shoulder Dia. D _a	K _a	K _b				
		mm in.	mm in.	mm in.	mm in.	mm in.	mm in.				kg lbs.
EE571602	572651D	6.4 0.25	453.0 17.83	1.5 0.06	629.5 24.78	– –	– –	3621.0	321.8	0.2093	240.38 529.94
H969249	H969210D	12.7 0.50	513.0 20.20	3.3 0.13	719.3 28.32	– –	– –	4614.9	207.4	0.2945	683.72 1507.37
EE285162	285228D	6.8 0.27	444.0 17.48	1.5 0.06	534.0 21.02	– –	– –	3036.6	478.1	0.2103	108.57 239.37
M270730	M270710CD	6.4 0.25	456.0 17.95	1.5 0.06	605.1 23.82	28.58 1.13	15.09 0.59	6865.6	481.9	0.2458	299.30 659.86
EE911618	912401D	6.8 0.27	447.0 17.60	1.5 0.06	569.0 22.40	– –	– –	3251.1	349.1	0.1990	156.34 344.71
M268749	M268710D	6.4 0.25	451.0 17.76	1.5 0.06	562.0 22.13	– –	– –	5754.9	420.9	0.2319	205.62 453.31
M268749	M268710CD	6.4 0.25	451.0 17.76	1.5 0.06	562.0 22.13	28.58 1.13	14.30 0.55	5754.9	420.9	0.2319	205.62 453.31
EE328167	328268D	12.7 0.50	482.0 18.98	3.3 0.13	636.1 25.04	– –	– –	5606.6	353.0	0.2443	404.83 892.55
EE241693	242376D	6.4 0.25	465.0 18.31	1.5 0.06	561.0 22.09	– –	– –	3353.8	551.6	0.2207	116.48 256.77
EE241693	242377CD	6.4 0.25	465.0 18.31	1.5 0.06	561.0 22.09	22.23 0.88	13.48 0.53	3353.8	551.6	0.2207	121.28 267.33
LM869448	LM869410CD	3.3 0.13	457.0 17.99	1.5 0.06	549.0 21.61	22.23 0.88	11.91 0.47	3719.4	491.5	0.2326	97.85 215.69
LM769349X	LM769310D	8.0 0.31	466.0 18.35	1.5 0.06	550.2 21.66	– –	– –	5114.6	614.2	0.2426	127.45 280.99
EE241701	242376D	6.4 0.25	446.0 18.35	1.5 0.06	561.0 22.09	– –	– –	3353.8	551.6	0.2207	116.79 257.47
EE241701	242377CD	6.4 0.25	446.0 18.35	1.5 0.06	561.0 22.09	22.23 0.88	13.48 0.53	3353.8	551.6	0.2207	120.47 265.58
EE571703	572651CD	6.4 0.25	472.0 18.58	1.5 0.06	629.5 24.78	25.40 1.00	15.09 0.59	3621.0	321.8	0.2093	220.94 487.09
EE571703	572651D	6.4 0.25	472.0 18.58	1.5 0.06	629.5 24.78	– –	– –	3621.0	321.8	0.2093	217.39 479.25
EE650170	650270D	6.4 0.25	477.0 18.78	3.3 0.13	648.5 25.53	– –	– –	7668.4	341.3	0.2542	502.35 1107.48

⁽⁴⁾These maximum fillet radii will be cleared by bearing corners.
NOTE: For spacer configuration information, contact your Timken engineer.

TAPERED ROLLER BEARINGS

DOUBLE-ROW • TYPE TDO

TYPE TDO



Bearing Dimensions				Load Ratings							
Bore d	O.D. D	Width T	Double Outer Ring Width C	Dynamic ⁽¹⁾		Factors ⁽²⁾		Dynamic ⁽³⁾			Factors ⁽²⁾
				C ₁₍₂₎	e	Y ₁	Y ₂	C ₉₀	C _{a90}	C ₉₀₍₂₎	K
mm in.	mm in.	mm in.	mm in.	N lbf				N lbf	N lbf	N lbf	
441.325 17.3750	660.400 26.0000	195.262 7.6875	138.112 5.4375	3070000 689000	0.37	1.80	2.69	457000 103000	292000 65700	795000 179000	1.56
441.325 17.3750	660.400 26.0000	195.262 7.6875	138.112 5.4375	3070000 689000	0.37	1.80	2.69	457000 103000	292000 65700	795000 179000	1.56
444.500 17.5000	517.525 20.3750	73.025 2.8750	53.975 2.1250	533000 120000	0.41	1.64	2.44	79300 17800	55800 12600	138000 31000	1.42
447.675 17.6250	635.000 25.0000	257.175 10.1250	206.375 8.1250	5700000 1280000	0.33	2.03	3.02	849000 191000	484000 109000	1480000 332000	1.76
447.675 17.6250	649.925 25.5876	257.175 10.1250	206.375 8.1250	5700000 1280000	0.33	2.03	3.02	849000 191000	484000 109000	1480000 332000	1.76
457.200 18.0000	596.900 23.5000	165.100 6.5000	120.650 4.7500	2460000 554000	0.40	1.67	2.48	367000 82400	254000 57100	639000 144000	1.44
457.200 18.0000	615.950 24.2500	184.150 7.2500	146.050 5.7500	3380000 760000	0.33	2.03	3.02	503000 113000	286000 64400	876000 197000	1.76
457.200 18.0000	660.400 26.0000	195.262 7.6875	138.112 5.4375	3070000 689000	0.37	1.80	2.69	457000 103000	292000 65700	795000 179000	1.56
457.200 18.0000	660.400 26.0000	195.262 7.6875	138.112 5.4375	3070000 689000	0.37	1.80	2.69	457000 103000	292000 65700	795000 179000	1.56
457.200 18.0000	660.400 26.0000	228.600 9.0000	171.450 6.7500	4340000 976000	0.32	2.12	3.15	646000 145000	353000 79300	1130000 253000	1.83
457.200 18.0000	730.148 28.7460	254.000 10.0000	177.800 7.0000	4920000 1110000	0.39	1.72	2.56	733000 165000	492000 111000	1280000 287000	1.49
476.250 18.7500	565.150 22.2500	95.250 3.7500	76.200 3.0000	817000 184000	0.47	1.44	2.14	122000 27400	97800 22000	212000 47600	1.24
479.425 18.8750	679.450 26.7500	276.225 10.8750	225.250 8.7500	6500000 1460000	0.33	2.03	3.02	968000 218000	551000 124000	1680000 379000	1.76
479.425 18.8750	679.450 26.7500	276.225 10.8750	225.250 8.7500	6500000 1460000	0.33	2.03	3.02	968000 218000	551000 124000	1680000 379000	1.76
482.600 19.0000	615.950 24.2500	184.150 7.2500	146.050 5.7500	2950000 662000	0.33	2.03	3.02	439000 98600	250000 56100	764000 172000	1.76
482.600 19.0000	615.950 24.2500	184.150 7.2500	146.050 5.7500	2950000 662000	0.33	2.03	3.02	439000 98600	250000 56100	764000 172000	1.76
482.600 19.0000	634.873 24.9950	177.800 7.0000	142.875 5.6250	2560000 574000	0.34	1.97	2.93	380000 85500	223000 50200	662000 149000	1.70

⁽¹⁾Based on 1×10^6 revolutions L_{10} life, for the ISO life-calculation method. $C_{1(2)}$ is the double-row radial value.

⁽²⁾Consult your Timken engineer for instructions on use or review the Timken Engineering Manual on timken.com/catalogs.

⁽³⁾Based on 90×10^6 revolutions L_{10} life, for The Timken Company life-calculation method. C_{90} and C_{a90} are radial and thrust values for a single row. $C_{90(2)}$ is the double-row radial value.

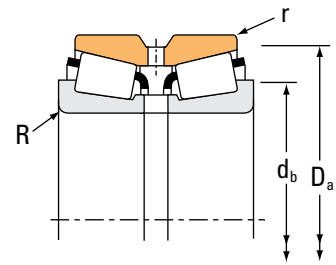
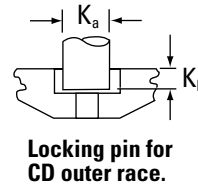
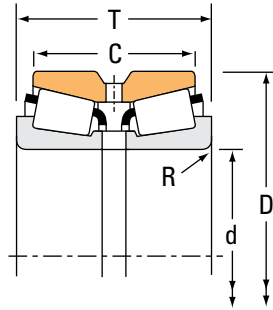
Part Number		Dimensions						Geometry Factors			Bearing Weight
Inner	Outer	Shaft		Housing		Pin		G ₁	G ₂	C _g	
		Max. Shaft Fillet Radius R ⁽⁴⁾	Backing Shoulder Dia. d _b	Max. Housing Fillet Radius r ⁽⁴⁾	Backing Shoulder Dia. D _a	K _a	K _b				
		mm in.	mm in.	mm in.	mm in.	mm in.	mm in.				kg lbs.
EE737173	737261CD	10.5 0.41	491.0 19.33	1.5 0.06	618.2 24.34	28.58 1.13	14.96 0.59	4809.1	573.4	0.2247	213.82 471.41
EE737173	737261D	10.5 0.41	491.0 19.33	1.5 0.06	618.2 24.34	–	–	4809.1	573.4	0.2247	206.89 456.13
LL669849	LL669810XD	3.5 0.14	461.0 18.15	1.5 0.06	504.0 19.84	–	–	2969.3	1487.2	0.2443	23.11 50.97
M270749	M270710CD	6.4 0.25	484.0 19.06	1.5 0.06	605.1 23.82	28.58 1.13	15.09 0.59	6865.6	481.9	0.2458	249.52 550.08
M270749	M270720D	6.4 0.25	484.0 19.06	1.5 0.06	605.1 23.82	–	–	6865.6	481.9	0.2458	279.40 615.96
EE244180	244236CD	9.7 0.38	494.0 19.45	1.5 0.06	570.0 22.47	28.58 1.13	11.91 0.47	4411.8	627.1	0.2233	105.70 232.99
LM272235	LM272210CD	6.4 0.25	493.0 19.41	1.5 0.06	597.0 23.48	28.58 1.13	10.34 0.41	6037.2	665.8	0.2333	148.11 326.50
EE737181	737261CD	10.5 0.41	503.9 19.84	1.5 0.06	618.2 24.34	28.58 1.13	14.96 0.59	4809.1	573.4	0.2247	199.03 438.77
EE737181	737261D	10.5 0.41	503.9 19.84	1.5 0.06	618.2 24.34	–	–	4809.1	573.4	0.2247	191.83 422.91
M271648	M271610D	6.4 0.25	493.0 19.41	1.5 0.06	629.1 24.77	–	–	5273.7	413.3	0.2208	230.13 507.36
EE671801	672875D	9.7 0.38	507.0 19.96	1.5 0.06	681.0 26.79	–	–	4968.3	343.4	0.2315	365.77 806.41
LL771948	LL771911CD	3.3 0.13	495.0 19.49	1.5 0.06	549.0 21.61	17.46 0.69	9.52 0.38	3792.4	1237.1	0.2189	42.52 93.75
M272749	M272710D	6.4 0.25	516.0 20.31	1.5 0.06	648.0 25.52	–	–	8110.8	508.6	0.2598	309.29 681.86
M272749	M272710CD	6.4 0.25	516.0 20.31	1.5 0.06	648.0 25.52	33.35 1.31	17.47 0.69	8110.8	508.6	0.2598	309.29 681.86
LM272249	LM272210D	6.4 0.25	513.0 20.20	1.5 0.06	597.0 23.48	–	–	6037.2	665.8	0.2333	122.39 269.82
LM272249	LM272210CD	6.4 0.25	513.0 20.20	1.5 0.06	597.0 23.48	28.58 1.13	10.34 0.41	6037.2	665.8	0.2333	122.39 269.82
EE243190	243251CD	6.4 0.25	516.0 20.31	1.5 0.06	609.0 24.00	28.58 1.13	13.48 0.53	6057.3	726.6	0.2350	140.99 310.85

⁽⁴⁾These maximum fillet radii will be cleared by bearing corners.
NOTE: For spacer configuration information, contact your Timken engineer.

TAPERED ROLLER BEARINGS

DOUBLE-ROW • TYPE TDO

TYPE TDO



Bearing Dimensions				Load Ratings							
Bore d	O.D. D	Width T	Double Outer Ring Width C	Dynamic ⁽¹⁾				Dynamic ⁽³⁾			
				C ₁₍₂₎	e	Y ₁	Y ₂	C ₉₀	C _{a90}	C ₉₀₍₂₎	K
mm in.	mm in.	mm in.	mm in.	N lbf				N lbf	N lbf	N lbf	
482.600 19.0000	634.873 24.9950	177.800 7.0000	142.875 5.6250	2560000 574000	0.34	1.97	2.93	380000 85500	223000 50200	662000 149000	1.70
488.671 19.2390	660.400 26.0000	206.375 8.1250	158.750 6.2500	4130000 928000	0.31	2.20	3.27	614000 138000	323000 72600	1070000 240000	1.90
488.671 19.2390	666.674 26.2470	206.375 8.1250	158.750 6.2500	4130000 928000	0.31	2.20	3.27	614000 138000	323000 72600	1070000 240000	1.90
488.950 19.2500	634.873 24.9950	180.975 7.1250	136.525 5.3750	3240000 728000	0.47	1.43	2.12	482000 108000	390000 87800	840000 189000	1.24
488.950 19.2500	660.400 26.0000	206.375 8.1250	158.750 6.2500	4130000 928000	0.31	2.20	3.27	614000 138000	323000 72600	1070000 240000	1.90
488.950 19.2500	660.400 26.0000	206.375 8.1250	158.750 6.2500	4130000 928000	0.31	2.20	3.27	614000 138000	323000 72600	1070000 240000	1.90
488.950 19.2500	660.400 26.0000	206.375 8.1250	158.750 6.2500	4130000 928000	0.31	2.20	3.27	614000 138000	323000 72600	1070000 240000	1.90
488.950 19.2500	666.674 26.2470	206.375 8.1250	158.750 6.2500	4130000 928000	0.31	2.20	3.27	614000 138000	323000 72600	1070000 240000	1.90
489.026 19.2530	634.873 24.9950	177.800 7.0000	142.875 5.6250	2560000 574000	0.34	1.97	2.93	380000 85500	223000 50200	662000 149000	1.70
489.026 19.2530	634.873 24.9950	177.800 7.0000	142.875 5.6250	2560000 574000	0.34	1.97	2.93	380000 85500	223000 50200	662000 149000	1.70
498.475 19.6250	634.873 24.9950	177.800 7.0000	142.875 5.6250	2560000 574000	0.34	1.97	2.93	380000 85500	223000 50200	662000 149000	1.70
498.475 19.6250	634.873 24.9950	177.800 7.0000	142.875 5.6250	2560000 574000	0.34	1.97	2.93	380000 85500	223000 50200	662000 149000	1.70
501.650 19.7500	711.200 28.0000	292.100 11.5000	231.775 9.1250	6150000 1380000	0.33	2.03	3.02	916000 206000	521000 117000	1590000 358000	1.76
508.000 20.0000	736.600 29.0000	186.502 7.3426	114.300 4.5000	3460000 778000	0.47	1.42	2.12	516000 116000	418000 94000	898000 202000	1.23
508.000 20.0000	838.200 33.0000	304.800 12.0000	222.250 8.7500	6290000 1410000	0.48	1.41	2.10	936000 210000	769000 173000	1630000 366000	1.22
514.350 20.2500	736.600 29.0000	186.502 7.3426	114.300 4.5000	3460000 778000	0.47	1.42	2.12	516000 116000	418000 94000	898000 202000	1.23
520.700 20.5000	736.600 29.0000	186.502 7.3426	114.300 4.5000	3460000 778000	0.47	1.42	2.12	516000 116000	418000 94000	898000 202000	1.23

⁽¹⁾Based on 1 x 10⁶ revolutions L₁₀ life, for the ISO life-calculation method. C₁₍₂₎ is the double-row radial value.

⁽²⁾Consult your Timken engineer for instructions on use or review the Timken Engineering Manual on timken.com/catalogs.

⁽³⁾Based on 90 x 10⁶ revolutions L₁₀ life, for The Timken Company life-calculation method. C₉₀ and C_{a90} are radial and thrust values for a single row. C₉₀₍₂₎ is the double-row radial value.

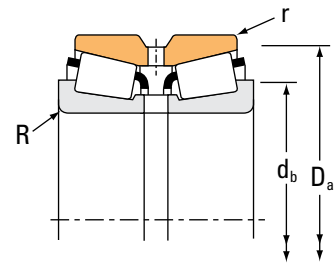
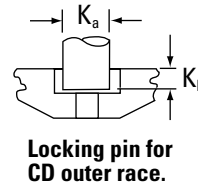
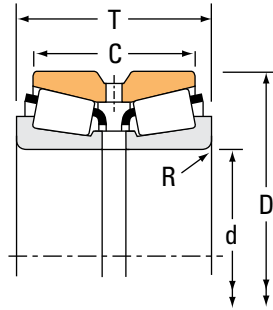
Part Number		Dimensions						Geometry Factors			Bearing Weight
Inner	Outer	Shaft		Housing		Pin		G ₁	G ₂	C _g	
		Max. Shaft Fillet Radius R ⁽⁴⁾	Backing Shoulder Dia. d _b	Max. Housing Fillet Radius r ⁽⁴⁾	Backing Shoulder Dia. D _a	K _a	K _b				
		mm in.	mm in.	mm in.	mm in.	mm in.	mm in.				kg lbs.
EE243190	243251D	6.4 0.25	516.0 20.31	1.5 0.06	609.0 24.00	– –	– –	6057.3	726.6	0.2350	141.71 312.43
EE640191	640261CD	6.4 0.25	522.0 20.55	1.5 0.06	630.4 24.82	28.58 1.13	15.87 0.63	6322.4	601.7	0.2310	186.18 410.43
EE640191	640262D	6.4 0.25	522.0 20.55	1.5 0.06	630.5 24.82	– –	– –	6322.4	601.7	0.2310	199.52 439.85
LM772748	LM772710CD	6.4 0.25	522.0 20.55	1.5 0.06	613.5 24.15	28.58 1.13	14.30 0.56	5447.5	602.2	0.2525	134.50 296.54
EE640192	640261CD	6.4 0.25	522.0 20.55	1.5 0.06	630.4 24.82	28.58 1.13	15.87 0.63	6322.4	601.7	0.2310	185.88 409.74
EE640192	640261XD	6.4 0.25	522.0 20.55	1.5 0.06	630.5 24.82	– –	– –	6322.4	601.7	0.2310	185.45 408.79
EE640192	640261CD	6.4 0.25	522.0 20.55	1.5 0.06	630.5 24.82	28.58 1.13	15.87 0.63	6322.4	601.7	0.2310	185.45 408.79
EE640192	640262D	6.4 0.25	522.0 20.55	1.5 0.06	630.5 24.82	– –	– –	6322.4	601.7	0.2310	199.22 439.15
EE243192	243251D	6.4 0.25	522.0 20.55	1.5 0.06	609.0 24.00	– –	– –	6057.3	726.6	0.2350	138.36 305.01
EE243192	243251CD	6.4 0.25	522.0 20.55	1.5 0.06	609.0 24.00	28.58 1.13	13.48 0.53	6057.3	726.6	0.2350	138.36 305.01
EE243196	243251D	6.4 0.25	528.0 20.79	1.5 0.06	609.0 24.00	– –	– –	6057.3	726.6	0.2350	129.16 284.77
EE243196	243251CD	6.4 0.25	528.0 20.79	1.5 0.06	609.0 24.00	28.58 1.13	13.48 0.53	6057.3	726.6	0.2350	129.16 284.77
M274149	M274110CD	6.4 0.25	540.0 21.26	1.5 0.06	678.0 26.69	33.35 1.31	16.99 0.67	9019.6	560.7	0.2690	354.07 780.61
EE982003	982901CD	6.4 0.25	549.0 21.61	1.5 0.06	684.0 26.93	25.40 1.00	15.87 0.63	4901.2	606.3	0.2429	227.52 501.59
EE426200	426331CD	9.7 0.38	564.0 22.20	3.3 0.13	767.7 30.23	38.10 1.50	20.65 0.81	6651.9	435.2	0.2722	601.74 1326.62
EE982028	982901CD	6.4 0.25	555.0 21.85	1.5 0.06	684.0 26.93	25.40 1.00	15.87 0.63	4901.2	606.3	0.2429	220.08 485.17
EE982051	982901CD	6.4 0.25	558.0 21.97	1.5 0.06	684.0 26.93	25.40 1.00	15.87 0.63	4901.2	606.3	0.2429	212.53 468.55

⁽⁴⁾These maximum fillet radii will be cleared by bearing corners.
NOTE: For spacer configuration information, contact your Timken engineer.

TAPERED ROLLER BEARINGS

DOUBLE-ROW • TYPE TDO

TYPE TDO



Bearing Dimensions				Load Ratings							
Bore d	O.D. D	Width T	Double Outer Ring Width C	Dynamic ⁽¹⁾				Dynamic ⁽³⁾			
				C ₁₍₂₎	e	Y ₁	Y ₂	C ₉₀	C _{a90}	C ₉₀₍₂₎	K
mm in.	mm in.	mm in.	mm in.	N lbf				N lbf	N lbf	N lbf	
533.400 21.0000	784.225 30.8750	190.500 7.5000	120.650 4.7500	3770000 848000	0.48	1.42	2.11	561000 126000	457000 103000	977000 220000	1.23
533.400 21.0000	812.800 32.0000	269.875 10.6250	187.325 7.3750	5200000 1170000	0.44	1.52	2.26	774000 174000	588000 132000	1350000 303000	1.32
533.400 21.0000	812.800 32.0000	269.875 10.6250	187.325 7.3750	5200000 1170000	0.44	1.52	2.26	774000 174000	588000 132000	1350000 303000	1.32
534.988 21.0625	622.300 24.5000	101.600 4.0000	73.025 2.8750	1160000 261000	0.37	1.83	2.73	173000 38900	109000 24500	301000 67700	1.59
534.988 21.0625	622.300 24.5000	111.125 4.3750	82.550 3.2500	1160000 261000	0.37	1.83	2.73	173000 38900	109000 24500	301000 67700	1.59
536.575 21.1250	761.873 29.9950	311.150 12.2500	247.650 9.7500	6980000 1570000	0.33	2.03	3.02	1040000 234000	592000 133000	1810000 407000	1.76
546.100 21.5000	736.600 29.0000	165.100 6.5000	114.300 4.5000	2440000 548000	0.51	1.33	1.98	363000 81600	316000 71000	632000 142000	1.15
549.275 21.6250	692.150 27.2500	174.625 6.8750	136.525 5.3750	2650000 595000	0.38	1.79	2.67	394000 88500	254000 57000	686000 154000	1.55
558.800 22.0000	736.600 29.0000	165.100 6.5000	114.300 4.5000	2440000 548000	0.51	1.33	1.98	363000 81600	316000 71000	632000 142000	1.15
558.800 22.0000	736.600 29.0000	187.328 7.3751	138.112 5.4375	3600000 810000	0.34	1.97	2.93	536000 121000	315000 70700	934000 210000	1.70
558.800 22.0000	736.600 29.0000	225.425 8.8750	177.800 7.0000	5130000 1150000	0.35	1.95	2.90	765000 172000	453000 102000	1330000 299000	1.69
558.800 22.0000	736.600 29.0000	225.425 8.8750	177.800 7.0000	4480000 1010000	0.35	1.95	2.90	667000 150000	395000 88800	1160000 261000	1.69
558.800 22.0000	742.950 29.2500	187.328 7.3751	138.112 5.4375	3600000 810000	0.34	1.97	2.93	536000 121000	315000 70700	934000 210000	1.70
558.800 22.0000	901.700 35.5000	292.100 11.5000	212.725 8.3750	6610000 1480000	0.41	1.65	2.46	984000 221000	687000 154000	1710000 385000	1.43
560.000 22.0472	820.000 32.2835	258.500 10.1772	185.000 7.2835	5250000 1180000	0.46	1.48	2.20	781000 176000	611000 137000	1360000 306000	1.28
560.000 22.0472	820.000 32.2835	268.000 10.5512	190.000 7.4803	5250000 1180000	0.46	1.48	2.20	781000 176000	611000 137000	1360000 306000	1.28
565.150 22.2500	863.600 34.0000	317.500 12.5000	228.600 9.0000	6960000 1570000	0.34	1.96	2.93	1040000 233000	610000 137000	1810000 406000	1.70

⁽¹⁾Based on 1 x 10⁶ revolutions L₁₀ life, for the ISO life-calculation method. C₁₍₂₎ is the double-row radial value.

⁽²⁾Consult your Timken engineer for instructions on use or review the Timken Engineering Manual on timken.com/catalogs.

⁽³⁾Based on 90 x 10⁶ revolutions L₁₀ life, for The Timken Company life-calculation method. C₉₀ and C_{a90} are radial and thrust values for a single row. C₉₀₍₂₎ is the double-row radial value.

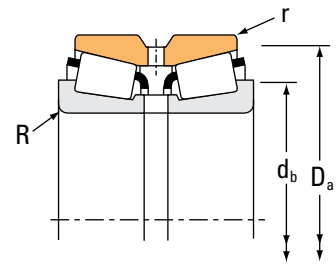
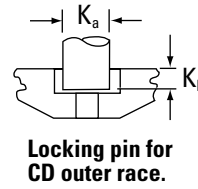
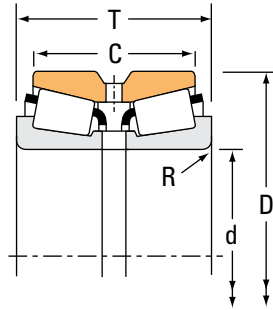
Part Number		Dimensions						Geometry Factors			Bearing Weight
Inner	Outer	Shaft		Housing		Pin		G ₁	G ₂	C _G	
		Max. Shaft Fillet Radius R ⁽⁴⁾	Backing Shoulder Dia. d _b	Max. Housing Fillet Radius r ⁽⁴⁾	Backing Shoulder Dia. D _a	K _a	K _b				
		mm in.	mm in.	mm in.	mm in.	mm in.	mm in.				kg lbs.
EE522102	523088D	6.4 0.25	576.0 22.68	1.5 0.06	733.8 28.89	– –	– –	5013.3	457.2	0.2452	263.14 580.10
EE626210	626321D	9.7 0.38	585.0 23.03	3.3 0.13	762.5 30.02	– –	– –	6364.0	563.1	0.2608	448.08 987.81
EE626210	626321CD	9.7 0.38	585.0 23.03	3.3 0.13	762.5 30.02	30.18 1.19	18.31 0.72	6364.0	563.1	0.2608	448.08 987.81
LL475048	LL475010D	3.5 0.14	552.0 21.73	1.5 0.06	609.0 23.98	– –	– –	4586.9	1294.0	0.2160	44.63 98.34
LL475048	LL475011D	3.5 0.14	552.0 21.73	1.5 0.06	609.0 23.98	– –	– –	4586.9	1294.0	0.2160	47.73 105.17
M276449	M276410CD	6.4 0.25	576.0 22.68	1.5 0.06	725.6 28.57	38.10 1.50	19.05 0.75	10625.0	614.5	0.2839	435.41 959.92
EE542215	542291CD	6.4 0.25	585.0 23.03	3.3 0.13	705.1 27.76	25.40 1.00	13.48 0.53	5727.7	782.5	0.2604	178.78 394.13
L476549	L476510CD	6.4 0.25	579.0 22.80	1.5 0.06	666.0 26.22	28.58 1.13	14.30 0.56	7261.6	889.8	0.2567	142.05 313.17
EE542220	542291CD	6.4 0.25	594.0 23.39	3.3 0.13	705.1 27.76	25.40 1.00	13.48 0.53	5727.7	782.5	0.2604	165.28 364.38
EE843220	843291CD	6.4 0.25	591.0 23.27	1.5 0.06	708.0 27.87	28.58 1.13	15.09 0.59	7097.5	714.8	0.2478	196.10 432.32
LM377448	LM377410CD	6.4 0.25	594.0 23.39	1.5 0.06	708.0 27.87	28.58 1.13	16.69 0.66	9314.8	907.6	0.2735	246.15 542.65
LM377449	LM377410CD	6.4 0.25	594.0 23.39	1.5 0.06	708.0 27.87	28.58 1.13	16.69 0.66	9314.8	907.6	0.2735	246.52 543.45
EE843220	843292D	6.4 0.25	591.0 23.27	1.5 0.06	707.1 27.84	– –	– –	7097.5	714.8	0.2478	204.62 451.10
EE327220	327357D	12.7 0.50	624.0 24.57	3.3 0.13	836.2 32.92	– –	– –	7790.8	478.4	0.2715	656.31 1447.54
NP915736	NP585761	8.0 0.31	606.0 23.86	3.5 0.14	783.0 30.83	28.58 1.13	17.37 0.68	6738.0	546.6	0.2682	406.98 897.06
NP934748	NP920752	10.0 0.39	606.0 23.86	3.5 0.14	783.0 30.83	28.58 1.13	17.37 0.68	6738.0	546.6	0.2682	412.68 909.79
EE929225	929341D	8.0 0.31	614.9 24.21	3.3 0.13	809.5 31.87	– –	– –	9118.4	670.2	0.2711	610.33 1345.54

⁽⁴⁾These maximum fillet radii will be cleared by bearing corners.
NOTE: For spacer configuration information, contact your Timken engineer.

TAPERED ROLLER BEARINGS

DOUBLE-ROW • TYPE TDO

TYPE TDO



Bearing Dimensions				Load Ratings							
Bore d	O.D. D	Width T	Double Outer Ring Width C	Dynamic ⁽¹⁾				Dynamic ⁽³⁾			
				C ₁₍₂₎	e	Y ₁	Y ₂	C ₉₀	C _{a90}	C ₉₀₍₂₎	K
mm in.	mm in.	mm in.	mm in.	N lbf				N lbf	N lbf	N lbf	
571.500 22.5000	812.800 32.0000	333.375 13.1250	263.525 10.3750	7890000 1770000	0.33	2.03	3.02	1180000 264000	669000 150000	2050000 460000	1.76
584.200 23.0000	762.000 30.0000	228.600 9.0000	169.862 6.6875	4220000 949000	0.47	1.43	2.12	628000 141000	509000 114000	1090000 246000	1.24
584.200 23.0000	901.700 35.5000	298.453 11.7501	214.312 8.4375	8670000 1950000	0.33	2.04	3.03	1290000 290000	732000 165000	2250000 505000	1.76
584.200 23.0000	901.700 35.5000	298.453 11.7501	214.312 8.4375	8670000 1950000	0.33	2.04	3.03	1290000 290000	732000 165000	2250000 505000	1.76
585.788 23.0625	771.525 30.3750	269.047 10.5924	212.725 8.3750	5730000 1290000	0.33	2.03	3.02	853000 192000	486000 109000	1490000 334000	1.76
602.945 23.7380	787.400 31.0000	206.375 8.1250	158.750 6.2500	3790000 852000	0.37	1.82	2.71	565000 127000	358000 80600	983000 221000	1.58
602.945 23.7380	787.400 31.0000	206.375 8.1250	158.750 6.2500	4550000 1020000	0.37	1.82	2.71	677000 152000	430000 96600	1180000 265000	1.58
602.945 23.7380	793.750 31.2500	206.375 8.1250	158.750 6.2500	4550000 1020000	0.37	1.82	2.71	677000 152000	430000 96600	1180000 265000	1.58
607.720 23.9260	787.400 31.0000	206.375 8.1250	158.750 6.2500	4550000 1020000	0.37	1.82	2.71	677000 152000	430000 96600	1180000 265000	1.58
607.720 23.9260	793.750 31.2500	206.375 8.1250	158.750 6.2500	4550000 1020000	0.37	1.82	2.71	677000 152000	430000 96600	1180000 265000	1.58
609.600 24.0000	717.550 28.2500	127.000 5.0000	95.250 3.7500	1640000 369000	0.40	1.68	2.50	244000 54900	168000 37800	425000 95600	1.45
609.600 24.0000	787.400 31.0000	206.375 8.1250	158.750 6.2500	4550000 1020000	0.37	1.82	2.71	677000 152000	430000 96600	1180000 265000	1.58
609.600 24.0000	787.400 31.0000	206.375 8.1250	158.750 6.2500	4420000 993000	0.37	1.82	2.71	657000 148000	417000 93800	1140000 257000	1.58
609.600 24.0000	793.750 31.2500	206.375 8.1250	158.750 6.2500	4550000 1020000	0.37	1.82	2.71	677000 152000	430000 96600	1180000 265000	1.58
609.600 24.0000	812.800 32.0000	190.500 7.5000	146.050 5.7500	3610000 812000	0.33	2.05	3.05	538000 121000	303000 68200	937000 211000	1.77
635.000 25.0000	933.450 36.7500	377.825 14.8750	301.625 11.8750	10200000 2290000	0.33	2.03	3.02	1520000 342000	865000 195000	2650000 595000	1.76
635.000 25.0000	990.600 39.0000	339.725 13.3750	212.725 8.3750	9370000 2110000	0.87	0.78	1.16	1390000 314000	2070000 465000	2430000 546000	0.67

⁽¹⁾Based on 1 x 10⁶ revolutions L₁₀ life, for the ISO life-calculation method. C₁₍₂₎ is the double-row radial value.

⁽²⁾Consult your Timken engineer for instructions on use or review the Timken Engineering Manual on timken.com/catalogs.

⁽³⁾Based on 90 x 10⁶ revolutions L₁₀ life, for The Timken Company life-calculation method. C₉₀ and C_{a90} are radial and thrust values for a single row. C₉₀₍₂₎ is the double-row radial value.

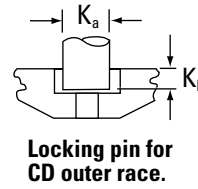
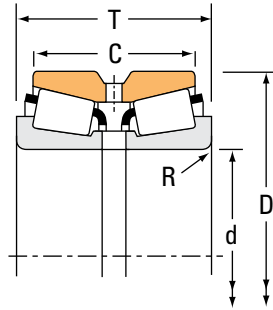
Part Number		Dimensions						Geometry Factors			Bearing Weight
Inner	Outer	Shaft		Housing		Pin		G ₁	G ₂	C _G	
		Max. Shaft Fillet Radius R ⁽⁴⁾	Backing Shoulder Dia. d _b	Max. Housing Fillet Radius r ⁽⁴⁾	Backing Shoulder Dia. D _a	K _a	K _b				
		mm in.	mm in.	mm in.	mm in.	mm in.	mm in.				kg lbs.
M278749	M278710CD	6.4 0.25	615.0 24.21	1.5 0.06	774.0 30.47	28.58 1.13	17.47 0.69	12425.1	669.4	0.2990	533.70 1176.59
LM778549	LM778510D	6.4 0.25	621.0 24.45	1.5 0.06	736.9 29.01	– –	– –	8573.3	722.5	0.2936	245.35 540.90
EE662303	663551CD	8.0 0.31	633.0 24.92	1.5 0.06	848.1 33.39	36.50 1.44	20.65 0.81	8756.7	477.1	0.2638	613.42 1352.38
EE662303	663551D	8.0 0.31	633.0 24.92	1.5 0.06	848.1 33.39	– –	– –	8756.7	477.1	0.2638	612.14 1349.57
LM278849	LM278810CD	6.4 0.25	621.0 24.45	1.5 0.06	744.0 29.29	36.50 1.44	17.47 0.69	11553.5	930.7	0.2906	323.60 713.42
EE649236X	649311CD	6.4 0.25	642.0 25.28	1.5 0.06	755.3 29.74	28.58 1.13	15.87 0.63	8978.8	1193.1	0.2746	243.77 537.43
EE649237	649311CD	6.4 0.25	639.0 25.16	1.5 0.06	755.3 29.74	28.58 1.13	15.87 0.63	9384.8	930.0	0.2790	247.25 545.03
EE649237	649313D	6.4 0.25	639.0 25.16	1.5 0.06	755.3 29.74	– –	– –	9384.8	930.0	0.2790	257.07 566.69
EE649239	649311CD	6.4 0.25	642.0 25.28	1.5 0.06	755.3 29.74	28.58 1.13	15.87 0.63	9384.8	930.0	0.2790	239.77 528.56
EE649239	649313D	6.4 0.25	642.0 25.28	1.5 0.06	755.3 29.74	– –	– –	9384.8	930.0	0.2790	249.59 550.21
LL579749	LL579710D	6.4 0.25	636.0 25.04	1.5 0.06	702.0 27.64	– –	– –	6863.4	1515.1	0.2544	81.33 179.29
EE649240	649311CD	6.4 0.25	642.0 25.28	1.5 0.06	755.3 29.74	28.58 1.13	15.87 0.63	9384.8	930.0	0.2790	236.28 520.87
EE649240H	649311CD	6.4 0.25	642.0 25.28	1.5 0.06	755.3 29.74	28.58 1.13	15.87 0.63	9115.2	904.3	0.2761	226.86 500.18
EE649240	649313D	6.4 0.25	642.0 25.28	1.5 0.06	755.3 29.74	– –	– –	9384.8	930.0	0.2790	241.96 533.40
EE743240	743321CD	6.4 0.25	645.0 25.39	3.3 0.13	765.1 30.12	28.58 1.13	17.47 0.69	7714.7	995.4	0.2499	243.11 535.98
M281635	M281610CD	12.0 0.47	699.0 27.52	1.5 0.06	890.0 35.04	38.10 1.50	21.43 0.84	17304.9	775.6	0.3335	865.96 1909.10
NP830348	NP547476	6.4 0.25	714.0 28.11	3.3 0.13	939.0 36.97	28.58 1.13	19.83 0.78	9855.8	434.7	0.3688	881.72 1943.87

⁽⁴⁾These maximum fillet radii will be cleared by bearing corners.
NOTE: For spacer configuration information, contact your Timken engineer.

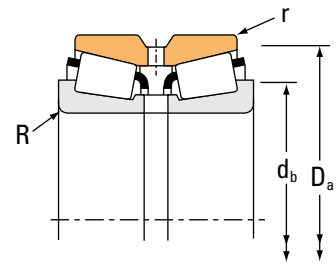
TAPERED ROLLER BEARINGS

DOUBLE-ROW • TYPE TDO

TYPE TDO



Locking pin for CD outer race.



Bearing Dimensions				Load Ratings							
Bore d	O.D. D	Width T	Double Outer Ring Width C	Dynamic ⁽¹⁾				Dynamic ⁽³⁾			
				C ₁₍₂₎	e	Y ₁	Y ₂	C ₉₀	C _{a90}	C ₉₀₍₂₎	K
mm in.	mm in.	mm in.	mm in.	N lbf				N lbf	N lbf	N lbf	
646.112 25.4375	857.250 33.7500	304.800 12.0000	241.300 9.5000	8180000 1840000	0.33	2.03	3.02	1220000 274000	694000 156000	2120000 477000	1.76
660.400 26.0000	812.800 32.0000	203.200 8.0000	158.750 6.2500	4760000 1070000	0.33	2.03	3.02	709000 159000	404000 90700	1230000 278000	1.76
660.400 26.0000	812.800 32.0000	203.200 8.0000	158.750 6.2500	4410000 992000	0.33	2.03	3.02	657000 148000	374000 84100	1140000 257000	1.76
660.400 26.0000	854.923 33.6584	186.329 7.3358	135.900 5.3504	3900000 877000	0.35	1.92	2.86	581000 131000	349000 78600	1010000 227000	1.66
679.450 26.7500	901.700 35.5000	307.975 12.1250	244.475 9.6250	8740000 1960000	0.33	2.03	3.02	1300000 292000	741000 166000	2260000 509000	1.76
682.625 26.8750	965.200 38.0000	396.875 15.6250	311.150 12.2500	10900000 2440000	0.33	2.03	3.02	1620000 364000	921000 207000	2820000 634000	1.76
685.800 27.0000	876.300 34.5000	200.025 7.8750	152.400 6.0000	4790000 1080000	0.42	1.62	2.42	714000 160000	508000 114000	1240000 279000	1.40
710.000 27.9528	899.925 35.4301	230.000 9.0551	166.002 6.5355	4990000 1120000	0.52	1.29	1.92	743000 167000	667000 150000	1290000 291000	1.11
711.200 28.0000	914.400 36.0000	190.500 7.5000	139.700 5.5000	4150000 934000	0.38	1.77	2.64	619000 139000	403000 90600	1080000 242000	1.54
719.930 28.3437	914.905 36.0199	189.240 7.4504	139.903 5.5080	4150000 934000	0.38	1.77	2.64	619000 139000	403000 90600	1080000 242000	1.54
723.900 28.5000	914.400 36.0000	187.325 7.3750	139.700 5.5000	4150000 934000	0.38	1.77	2.64	619000 139000	403000 90600	1080000 242000	1.54
723.900 28.5000	1003.300 39.5000	187.325 7.3750	139.700 5.5000	4150000 934000	0.38	1.77	2.64	619000 139000	403000 90600	1080000 242000	1.54
749.300 29.5000	965.200 38.0000	187.325 7.3750	133.350 5.2500	4270000 961000	0.40	1.68	2.50	636000 143000	438000 98400	1110000 249000	1.45
749.300 29.5000	990.600 39.0000	338.000 13.3071	265.000 10.4331	10400000 2340000	0.33	2.03	3.02	1550000 349000	883000 198000	2700000 607000	1.76
762.000 30.0000	965.200 38.0000	187.325 7.3750	133.350 5.2500	4270000 961000	0.40	1.68	2.50	636000 143000	438000 98400	1110000 249000	1.45
774.700 30.5000	965.200 38.0000	187.325 7.3750	133.350 5.2500	4270000 961000	0.40	1.68	2.50	636000 143000	438000 98400	1110000 249000	1.45
774.700 30.5000	965.200 38.0000	187.325 7.3750	133.350 5.2500	4270000 961000	0.40	1.68	2.50	636000 143000	438000 98400	1110000 249000	1.45

⁽¹⁾Based on 1×10^6 revolutions L_{10} life, for the ISO life-calculation method. $C_{1(2)}$ is the double-row radial value.

⁽²⁾Consult your Timken engineer for instructions on use or review the Timken Engineering Manual on timken.com/catalogs.

⁽³⁾Based on 90×10^6 revolutions L_{10} life, for The Timken Company life-calculation method. C_{90} and C_{a90} are radial and thrust values for a single row. $C_{90(2)}$ is the double-row radial value.

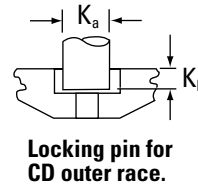
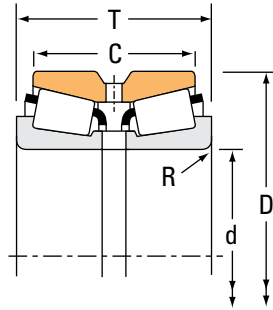
Part Number		Dimensions						Geometry Factors			Bearing Weight
Inner	Outer	Shaft		Housing		Pin		G ₁	G ₂	C _G	
		Max. Shaft Fillet Radius R ⁽⁴⁾	Backing Shoulder Dia. d _b	Max. Housing Fillet Radius r ⁽⁴⁾	Backing Shoulder Dia. D _a	K _a	K _b				
		mm in.	mm in.	mm in.	mm in.	mm in.	mm in.				kg lbs.
LM281049	LM281010CD	6.4 0.25	684.0 26.93	1.5 0.06	824.5 32.46	28.58 1.13	18.26 0.72	14763.0	920.6	0.3153	460.91 1016.14
L281147	L281110CD	6.4 0.25	693.0 27.28	1.5 0.06	789.0 31.04	28.58 1.13	14.30 0.56	12635.6	984.9	0.2968	214.58 473.07
L281148	L281110CD	6.4 0.25	693.0 27.28	1.5 0.06	789.0 31.04	28.58 1.13	14.30 0.56	11705.7	915.8	0.2888	207.09 456.55
EE749260	749335CD	9.7 0.38	702.0 27.64	2.3 0.09	813.0 32.01	28.58 1.13	17.45 0.69	9222.1	1151.5	0.2707	241.40 532.16
LM281849	LM281810CD	9.7 0.38	726.0 28.58	1.5 0.06	866.6 34.12	39.70 1.56	22.22 0.88	16257.4	961.7	0.3252	513.79 1132.66
M282249	M282210CD	9.7 0.38	738.0 29.06	1.5 0.06	919.8 36.21	33.35 1.31	20.65 0.81	18773.0	843.1	0.3426	888.15 1958.07
EE655270	655346CD	6.4 0.25	723.0 28.46	1.5 0.06	841.4 33.13	28.58 1.13	17.47 0.69	11844.1	1202.6	0.3119	281.13 619.75
L882449	L882410CD	6.4 0.25	750.0 29.53	3.3 0.13	873.0 34.37	25.40 1.00	18.26 0.72	13015.8	1127.2	0.3473	331.66 731.22
EE755280	755361CD	6.4 0.25	750.0 29.53	3.3 0.13	877.0 34.53	28.58 1.13	15.87 0.63	11122.5	1282.2	0.2952	293.06 646.07
EE755282	755358XD	4.8 0.19	753.0 29.65	1.5 0.06	876.6 34.51	– –	– –	11122.5	1282.2	0.2952	277.57 611.93
EE755285	755361CD	5.5 0.22	756.0 29.76	3.3 0.13	877.0 34.53	28.58 1.13	15.87 0.63	11122.5	1282.2	0.2952	269.79 594.79
EE755285	755367CD	5.5 0.22	756.0 29.76	3.3 0.13	912.0 35.91	28.58 1.13	19.86 0.78	11122.5	1282.2	0.2952	409.60 903.01
EE752295	752381D	6.4 0.25	789.0 31.06	1.5 0.06	923.5 36.36	– –	– –	12456.8	1880.8	0.3116	304.73 671.84
LM283649	LM283610CD	6.4 0.25	792.0 31.18	3.3 0.13	952.4 37.50	33.35 1.31	21.43 0.84	20904.8	1142.9	0.3534	680.96 1501.25
EE752300	752381D	6.4 0.25	798.0 31.42	1.5 0.06	923.5 36.36	– –	– –	12456.8	1880.8	0.3116	295.64 651.81
EE752305	752381D	6.4 0.25	810.0 31.89	1.5 0.06	923.5 36.36	– –	– –	12456.8	1880.8	0.3116	279.45 616.08
EE752305	752381CD	6.4 0.25	810.0 31.89	1.5 0.06	923.5 36.36	28.58 1.13	11.91 0.47	12456.8	1880.8	0.3116	279.45 616.08

⁽⁴⁾These maximum fillet radii will be cleared by bearing corners.
NOTE: For spacer configuration information, contact your Timken engineer.

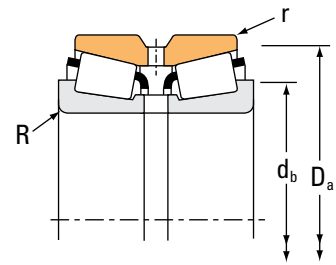
TAPERED ROLLER BEARINGS

TYPE TDO

TYPE TDO



Locking pin for CD outer race.



Bearing Dimensions				Load Ratings							
Bore d	O.D. D	Width T	Double Outer Ring Width C	Dynamic ⁽¹⁾				Dynamic ⁽³⁾			
				C ₁₍₂₎	e	Y ₁	Y ₂	C ₉₀	C _{a90}	C ₉₀₍₂₎	K
mm in.	mm in.	mm in.	mm in.	N lbf				N lbf	N lbf	N lbf	
812.800 32.0000	1016.000 40.0000	190.500 7.5000	146.050 5.7500	4300000 968000	0.43	1.59	2.36	641000 144000	467000 105000	1120000 251000	1.37
812.800 32.0000	1066.800 42.0000	190.500 7.5000	146.050 5.7500	4300000 968000	0.43	1.59	2.36	641000 144000	467000 105000	1120000 251000	1.37
838.200 33.0000	1041.400 41.0000	190.500 7.5000	123.825 4.8750	4410000 991000	0.44	1.54	2.30	657000 148000	492000 111000	1140000 257000	1.33
850.000 33.4646	1120.000 44.0945	267.000 10.5118	190.000 7.4803	8520000 1920000	0.46	1.47	2.19	1270000 285000	996000 224000	2210000 497000	1.27
863.600 34.0000	1130.300 44.5000	371.475 14.6250	298.450 11.7500	11400000 2550000	0.33	2.03	3.02	1690000 380000	963000 216000	2940000 662000	1.76
863.600 34.0000	1371.600 54.0000	469.900 18.5000	285.750 11.2500	16500000 3710000	0.87	0.78	1.16	2460000 553000	3650000 820000	4280000 962000	0.67
914.400 36.0000	1066.800 42.0000	139.700 5.5000	101.600 4.0000	2820000 633000	0.41	1.65	2.45	420000 94300	294000 66100	731000 164000	1.43
938.212 36.9375	1270.000 50.0000	406.200 15.9921	266.500 10.4921	12600000 2820000	0.87	0.78	1.16	1870000 420000	2770000 623000	3250000 732000	0.67
977.900 38.5000	1130.300 44.5000	139.700 5.5000	101.600 4.0000	2910000 654000	0.44	1.55	2.30	433000 97300	323000 72700	754000 169000	1.34
1270.000 50.0000	1435.100 56.5000	146.050 5.7500	101.600 4.0000	3210000 721000	0.57	1.18	1.76	478000 107000	467000 105000	832000 187000	1.02
1395.603 54.9450	1697.038 66.8125	260.350 10.2500	190.500 7.5000	7550000 1700000	0.43	1.56	2.32	1120000 253000	835000 188000	1960000 440000	1.35
1397.000 55.0000	1697.038 66.8125	260.350 10.2500	190.500 7.5000	7550000 1700000	0.43	1.56	2.32	1120000 253000	835000 188000	1960000 440000	1.35
1397.000 55.0000	1697.038 66.8125	260.350 10.2500	190.500 7.5000	7550000 1700000	0.43	1.56	2.32	1120000 253000	835000 188000	1960000 440000	1.35
1784.350 70.2500	2006.600 79.0000	241.300 9.5000	177.800 7.0000	8410000 1890000	0.44	1.54	2.29	1250000 282000	943000 212000	2180000 490000	1.33
1828.800 72.0000	2006.600 79.0000	177.800 7.0000	123.825 4.8750	5080000 1140000	0.47	1.43	2.12	757000 170000	613000 138000	1320000 296000	1.23

⁽¹⁾Based on 1×10^6 revolutions L_{10} life, for the ISO life-calculation method. $C_{1(2)}$ is the double-row radial value.

⁽²⁾Consult your Timken engineer for instructions on use or review the Timken Engineering Manual on timken.com/catalogs.

⁽³⁾Based on 90×10^6 revolutions L_{10} life, for The Timken Company life-calculation method. C_{90} and C_{a90} are radial and thrust values for a single row. $C_{90(2)}$ is the double-row radial value.

Part Number		Dimensions						Geometry Factors			Bearing Weight
Inner	Outer	Shaft		Housing		Pin		G ₁	G ₂	C _G	
		Max. Shaft Fillet Radius R ⁽⁴⁾	Backing Shoulder Dia. d _b	Max. Housing Fillet Radius r ⁽⁴⁾	Backing Shoulder Dia. D _a	K _a	K _b				
		mm in.	mm in.	mm in.	mm in.	mm in.	mm in.				kg lbs.
EE762320	762401D	6.4 0.25	849.0 33.43	1.5 0.06	976.6 38.45	–	–	13724.5	1634.7	0.3271	322.80 711.62
EE762320	762420XD	6.4 0.25	849.0 33.43	3.3 0.13	976.6 38.45	–	–	13724.5	1634.7	0.3271	427.99 943.52
EE763330	763410D	6.4 0.25	876.0 34.49	1.5 0.06	997.2 39.26	–	–	14677.1	1745.2	0.3374	323.40 712.98
NP442420	NP961009	8.0 0.32	900.0 35.43	3.5 0.14	1075.0 42.32	19.06 0.88	19.68 0.78	18466.6	1277.1	0.3733	660.60 1455.13
LM286249AA	LM286210CD	9.7 0.38	915.0 36.02	3.3 0.13	1090.4 42.93	38.10 1.50	24.61 0.97	28956.1	1086.1	0.3933	945.89 2085.33
LM986949	LM986910D	28.7 1.13	996.0 39.21	6.4 0.25	1290.0 50.79	–	–	20590.9	730.3	0.4700	2332.37 5142.00
LL686947	LL686910D	6.4 0.25	945.0 37.20	3.3 0.13	1037.2 40.83	–	–	16664.7	3390.4	0.3416	198.26 437.09
NP578395	NP508551	3.3 0.13	1005.0 39.57	3.3 0.13	1240.0 48.82	–	–	22762.7	983.1	0.4847	1361.12 3000.56
LL687949	LL687910D	6.4 0.25	1010.0 39.76	3.3 0.13	1100.0 43.32	–	–	18937.3	3190.6	0.3631	212.33 468.17
LL889049	LL889010D	6.4 0.25	1305.0 51.38	3.3 0.13	1405.0 55.31	–	–	31422.7	5654.9	0.4637	311.03 685.75
EE292548	292668D	6.0 0.24	1445.0 56.89	3.3 0.13	1619.6 63.76	–	–	58328.4	6111.6	0.5280	1061.43 2340.06
EE292550	292668D	6.0 0.24	1450.0 57.09	3.3 0.13	1619.6 63.76	–	–	58328.4	6111.6	0.5280	1055.81 2327.65
EE292550	292668CD	6.0 0.24	1450.0 57.09	3.3 0.13	1619.6 63.76	34.93 1.38	29.69 1.17	58328.4	6111.6	0.5280	1055.81 2327.65
LL789849	LL789810D	12.7 0.50	1840.0 72.44	3.3 0.13	1966.1 77.40	–	–	93391.2	10455.2	0.6160	978.66 2157.55
LL789949	LL789910XD	6.4 0.25	1865.0 73.43	3.3 0.13	1970.0 77.56	–	–	83190.9	15410.2	0.6006	589.45 1299.53

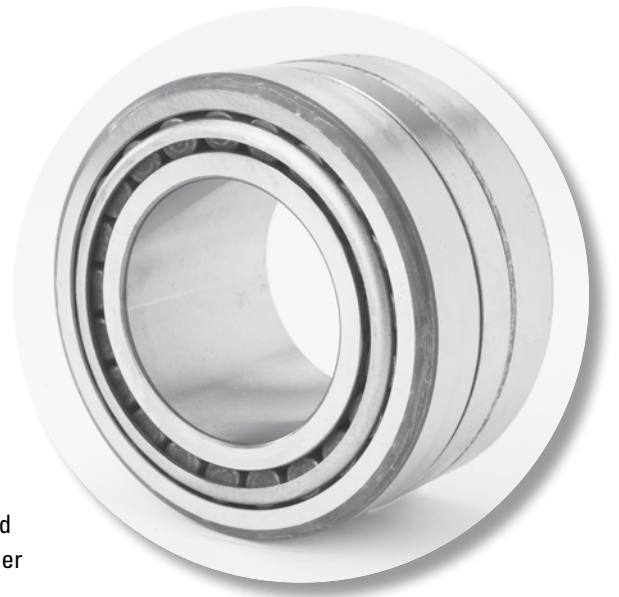
⁽⁴⁾These maximum fillet radii will be cleared by bearing corners.
NOTE: For spacer configuration information, contact your Timken engineer.

TAPERED ROLLER BEARINGS

DOUBLE-ROW • TYPE TDI • TYPE TDIT

TYPE TDI

- TDI style consists of a single-piece (double) inner ring plus two single outer rings.
- It is normally supplied complete with an outer-ring spacer as a pre-set assembly.
- To suit the application duty, the built-in setting value needs to be established by your Timken engineer before an order is placed.
- A groove and holes can be supplied in the outer-ring spacer to allow lubricant to pass from the bearing housing. Contact your Timken engineer for spacer configuration information.
- Consult your Timken engineer before making a final bearing selection to help ensure suitability, availability and the most cost-effective solution.



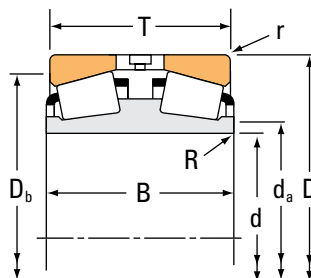
TYPE TDIT

- TDIT is a double inner-ring bearing with a tapered bore.
- It is comprised of a one-piece (double) inner ring and two single outer rings.
- TDIT bearings are typically supplied complete with an outer-ring spacer as a pre-set assembly. Contact your Timken engineer for spacer configuration information.
- These can be used in fixed (locating) positions on rotating-shaft applications.
- The tapered inner-ring bore allows for easy removal where interference fits are necessary and frequent removal of the bearing from the shaft is desired.
- Consult your Timken engineer before making a final bearing selection to help ensure suitability, availability and the most cost-effective solution.

TAPERED ROLLER BEARINGS

DOUBLE-ROW • TYPE TDI

TYPE TDI



Bearing Dimensions				Load Ratings							
Bore d	O.D. D	Width T	Double Inner Ring Width B	Dynamic ⁽¹⁾				Dynamic ⁽³⁾			
				C ₁₍₂₎	e	Y ₁	Y ₂	C ₉₀	C _{a90}	C ₉₀₍₂₎	K
mm in.	mm in.	mm in.	mm in.	N lbf				N lbf	N lbf	N lbf	
31.750 1.2500	69.012 2.7170	39.705 1.5632	39.182 1.5426	95100 21400	0.4	1.8	2.6	14200 3180	9260 2080	24600 5540	1.53
42.862 1.6875	80.962 3.1875	34.925 1.3750	31.750 1.2500	88500 19900	0.5	1.3	1.9	13200 2960	11900 2680	22900 5160	1.11
44.450 1.7500	80.962 3.1875	34.925 1.3750	31.750 1.2500	88500 19900	0.5	1.3	1.9	13200 2960	11900 2680	22900 5160	1.11
46.037 1.8125	80.962 3.1875	34.925 1.3750	31.750 1.2500	88500 19900	0.5	1.3	1.9	13200 2960	11900 2680	22900 5160	1.11
50.800 2.0000	93.264 3.6718	50.013 1.9690	53.188 2.0940	153000 34400	0.3	2.0	3.0	22800 5120	13200 2970	39700 8920	1.73
50.800 2.0000	96.838 3.8125	53.188 2.0940	53.188 2.0940	153000 34400	0.3	2.0	3.0	22800 5120	13200 2970	39700 8920	1.73
55.562 2.1875	96.838 3.8125	51.298 2.0196	53.188 2.0940	158000 35600	0.4	1.9	2.8	23600 5300	14300 3210	41100 9230	1.65
63.500 2.5000	112.712 4.4375	60.325 2.3750	60.325 2.3750	291000 65300	0.3	2.0	3.0	43300 9730	25100 5650	75400 16900	1.72
63.500 2.5000	136.525 5.3750	66.091 2.6020	65.989 2.5980	298000 66900	0.9	0.8	1.2	44300 9970	65700 14800	77200 17400	0.67
63.500 2.5000	140.030 5.5130	66.090 2.6020	65.989 2.5980	298000 66900	0.9	0.8	1.2	44300 9970	65700 14800	77200 17400	0.67
64.987 2.5586	136.525 5.3750	66.091 2.6020	65.989 2.5980	298000 66900	0.9	0.8	1.2	44300 9970	65700 14800	77200 17400	0.67
64.987 2.5586	140.030 5.5130	66.091 2.6020	65.989 2.5980	298000 66900	0.9	0.8	1.2	44300 9970	65700 14800	77200 17400	0.67
80.962 3.1875	133.350 5.2500	60.325 2.3750	59.538 2.3440	269000 60500	0.4	1.5	2.3	40000 9000	30500 6850	69700 15700	1.31
80.962 3.1875	136.525 5.3750	60.325 2.3750	59.538 2.3440	269000 60500	0.4	1.5	2.3	40000 9000	30500 6850	69700 15700	1.31
80.962 3.1875	139.992 5.5115	80.962 3.1875	80.134 3.1549	360000 80900	0.4	1.7	2.5	53600 12100	37100 8330	93400 21000	1.45
85.725 3.3750	123.825 4.8750	41.278 1.6251	44.450 1.7500	161000 36300	0.3	2.1	3.1	24000 5400	13600 3050	41800 9400	1.77
85.725 3.3750	127.000 5.0000	41.278 1.6251	44.450 1.7500	161000 36300	0.3	2.1	3.1	24000 5400	13600 3050	41800 9400	1.77

⁽¹⁾Based on 1 x 10⁶ revolutions L₁₀ life, for the ISO life-calculation method. C₁₍₂₎ is the double-row radial value.

⁽²⁾Consult your Timken engineer for instructions on use or review the Timken Engineering Manual on timken.com/catalogs.

⁽³⁾Based on 90 x 10⁶ revolutions L₁₀ life, for The Timken Company life-calculation method. C₉₀ and C_{a90} are radial and thrust values for a single row. C₉₀₍₂₎ is the double-row radial value.

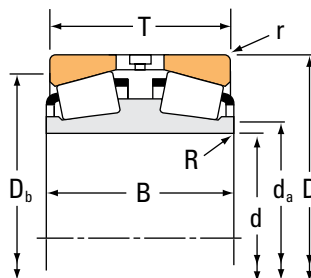
Part Number		Dimensions				Geometry Factors			Bearing Weight
Inner	Outer	Shaft		Housing		G ₁	G ₂	C _g	
		Max Shaft Fillet Radius R ⁽⁴⁾	Backing Shoulder Dia. d _a	Max Housing Fillet Radius r ⁽⁴⁾	Backing Shoulder Dia. D _b				
		mm in.	mm in.	mm in.	mm in.				kg lbs.
14126D	14276	1.5 0.06	40.0 1.57	1.3 0.05	60.0 2.36	18.0	13.3	0.0668	0.71 1.57
13169D	13318	0.8 0.03	50.0 1.97	1.5 0.06	72.0 2.83	23.0	19.2	0.0799	0.77 1.71
13176D	13318	0.1 0.01	50.0 1.97	1.5 0.06	72.0 2.83	23.0	19.2	0.0799	0.74 1.65
13182D	13318	0.8 0.03	52.0 2.05	1.5 0.06	72.0 2.83	23.0	19.2	0.0799	0.73 1.62
375D	374	0.8 0.03	57.0 2.24	1.3 0.05	85.0 3.35	37.6	15.4	0.0816	1.40 3.09
375D	372A	0.8 0.03	57.0 2.24	1.5 0.06	86.0 3.39	37.6	15.4	0.0816	1.61 3.56
389DE	382A	0.8 0.03	63.0 2.48	0.8 0.03	89.0 3.50	42.0	15.7	0.0859	2.05 4.50
39585D	39520	0.8 0.03	72.0 2.83	3.3 0.13	101.0 3.98	84.3	23.7	0.1074	2.59 5.70
78251D	78537	2.3 0.09	79.0 3.11	3.3 0.13	115.0 4.53	62.6	19.1	0.0884	4.59 10.10
78251D	78551	2.3 0.09	79.0 3.11	2.3 0.09	117.0 4.61	62.6	19.1	0.0884	4.83 10.66
78255D	78537	1.5 0.06	79.0 3.11	3.3 0.13	115.0 4.53	62.6	19.1	0.0884	4.55 10.03
78255D	78551	1.5 0.06	79.0 3.11	2.3 0.09	117.0 4.61	62.6	19.1	0.0884	4.91 10.85
496D	492A	1.5 0.06	91.0 3.58	3.3 0.13	120.0 4.72	104.6	29.3	0.1252	3.25 7.16
496D	493	1.5 0.06	91.0 3.58	3.3 0.13	122.0 4.80	104.6	29.3	0.1252	3.53 7.77
581D	572	1.5 0.06	92.0 3.62	3.3 0.13	125.0 4.92	125.7	32.0	0.1295	5.31 11.71
L217845D	L217810	0.8 0.03	93.0 3.66	1.5 0.06	116.0 4.57	111.3	74.8	0.1152	1.74 3.80
L217845D	L217813	0.8 0.03	93.0 3.66	1.5 0.06	117.0 4.61	111.3	74.8	0.1152	1.93 4.23

⁽⁴⁾These maximum fillet radii will be cleared by bearing corners.
NOTE: For spacer configuration information, contact your Timken engineer.

TAPERED ROLLER BEARINGS

DOUBLE-ROW • TYPE TDI

TYPE TDI



Bearing Dimensions				Load Ratings							
Bore d	O.D. D	Width T	Double Inner Ring Width B	Dynamic ⁽¹⁾				Dynamic ⁽³⁾			
				C ₁₍₂₎	e	Y ₁	Y ₂	C ₉₀	C _{a90}	C ₉₀₍₂₎	K
mm in.	mm in.	mm in.	mm in.	N lbf				N lbf	N lbf	N lbf	
88.900 3.5000	161.925 6.3750	101.549 3.9980	107.950 4.2500	570000 128000	0.3	2.0	3.0	84800 19100	49500 11100	148000 33200	1.71
92.075 3.6250	148.430 5.8437	57.150 2.2500	57.942 2.2812	284000 63800	0.5	1.4	2.0	42200 9490	35600 8000	73500 16500	1.19
95.250 3.7500	136.525 5.3750	57.150 2.2500	57.150 2.2500	243000 54600	0.3	2.4	3.5	36200 8140	17600 3950	63000 14200	2.06
98.425 3.8750	180.975 7.1250	101.600 4.0000	102.362 4.0300	603000 135000	0.4	1.8	2.6	89700 20200	59200 13300	156000 35100	1.51
101.600 4.0000	157.162 6.1875	80.167 3.1562	79.375 3.1250	389000 87500	0.5	1.4	2.1	57900 13000	47100 10600	101000 22700	1.23
101.600 4.0000	161.925 6.3750	86.518 3.4062	79.375 3.1250	389000 87500	0.5	1.4	2.1	57900 13000	47100 10600	101000 22700	1.23
104.775 4.1250	180.975 7.1250	101.600 4.0000	102.362 4.0300	603000 135000	0.4	1.8	2.6	89700 20200	59200 13300	156000 35100	1.51
107.950 4.2500	212.725 8.3750	142.875 5.6250	152.400 6.0000	996000 224000	0.3	2.1	3.1	148000 33300	82700 18600	258000 58000	1.79
114.300 4.5000	190.500 7.5000	98.425 3.8750	101.600 4.0000	633000 142000	0.4	1.6	2.4	94300 21200	67100 15100	164000 36900	1.40
114.300 4.5000	212.725 8.3750	142.875 5.6250	152.400 6.0000	1180000 266000	0.3	2.1	3.1	176000 39600	98300 22100	307000 69000	1.79
120.650 4.7500	174.625 6.8750	66.678 2.6251	68.262 2.6875	426000 95700	0.3	2.0	3.0	63400 14200	36100 8110	110000 24800	1.76
127.000 5.0000	196.850 7.7500	92.075 3.6250	92.075 3.6250	640000 144000	0.3	2.0	2.9	95300 21400	56100 12600	166000 37300	1.70
127.000 5.0000	228.600 9.0000	160.338 6.3125	151.244 5.9545	655000 147000	0.7	0.9	1.4	97500 21900	123000 27600	170000 38200	0.79
127.000 5.0000	234.950 9.2500	139.700 5.5000	152.400 6.0000	1090000 246000	0.4	1.8	2.7	163000 36700	103000 23200	284000 63800	1.58
130.005 5.1183	215.900 8.5000	123.825 4.8750	123.825 4.8750	665000 150000	0.5	1.4	2.1	99000 22300	82600 18600	172000 38800	1.20
130.175 5.1250	215.900 8.5000	101.600 4.0000	101.600 4.0000	665000 150000	0.5	1.4	2.1	99000 22300	82600 18600	172000 38800	1.20
133.350 5.2500	196.850 7.7500	92.075 3.6250	92.075 3.6250	640000 144000	0.3	2.0	2.9	95300 21400	56100 12600	166000 37300	1.70

⁽¹⁾Based on 1 x 10⁶ revolutions L₁₀ life, for the ISO life-calculation method. C₁₍₂₎ is the double-row radial value.

⁽²⁾Consult your Timken engineer for instructions on use or review the Timken Engineering Manual on timken.com/catalogs.

⁽³⁾Based on 90 x 10⁶ revolutions L₁₀ life, for The Timken Company life-calculation method. C₉₀ and C_{a90} are radial and thrust values for a single row. C₉₀₍₂₎ is the double-row radial value.

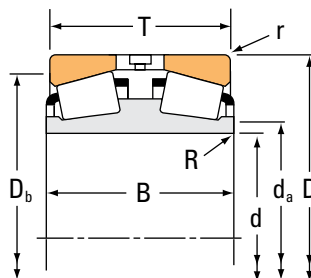
Part Number		Dimensions				Geometry Factors			Bearing Weight
Inner	Outer	Shaft		Housing		G ₁	G ₂	C _g	
		Max Shaft Fillet Radius R ⁽⁴⁾	Backing Shoulder Dia. d _a	Max Housing Fillet Radius r ⁽⁴⁾	Backing Shoulder Dia. D _b				
		mm in.	mm in.	mm in.	mm in.				kg lbs.
767D	752	1.5 0.06	101.3 3.99	3.3 0.13	144.0 5.67	177.2	29.4	0.0945	8.77 19.33
42362D	42584	1.5 0.06	104.0 4.09	3.0 0.12	134.0 5.28	129.7	37.2	0.1386	3.87 8.53
LM119348D	LM119311	0.8 0.03	102.0 4.02	2.3 0.09	126.0 4.96	149.4	84.1	0.1213	2.68 5.91
779D	772	1.5 0.06	112.0 4.41	3.3 0.13	161.0 6.34	227.3	41.3	0.1067	11.33 24.99
52400D	52618	1.5 0.06	112.4 4.43	3.3 0.13	142.0 5.59	175.4	41.7	0.1519	5.29 11.67
52400D	52638	1.5 0.06	112.4 4.43	3.3 0.13	143.0 5.63	175.4	41.7	0.1519	6.28 13.83
782D	772	1.5 0.06	117.9 4.64	3.3 0.13	161.0 6.34	227.3	41.3	0.1067	10.68 23.57
946D	932	3.3 0.13	128.0 5.04	3.3 0.13	187.0 7.36	338.6	39.8	0.1153	22.94 50.60
71450D	71750	1.5 0.06	128.0 5.04	3.3 0.13	171.0 6.73	269.2	49.5	0.1156	11.01 24.27
HH224346DD	HH224310	3.3 0.13	133.2 5.24	3.3 0.13	192.0 7.56	366.6	47.9	0.1182	22.01 48.52
M224749D	M224710	0.8 0.03	129.0 5.08	1.5 0.06	162.0 6.38	279.1	86.6	0.1575	5.82 12.83
67388D	67322	1.5 0.06	140.0 5.51	3.3 0.13	180.0 7.09	383.7	70.1	0.1220	10.66 23.52
97500D	97900	1.5 0.06	144.0 5.67	3.3 0.13	197.0 7.76	237.1	44.6	0.1311	24.49 53.96
95499D	95925	5.0 0.20	152.0 5.98	3.3 0.13	209.0 8.23	453.9	59.4	0.1323	25.95 57.23
74510D	74850	1.5 0.06	146.0 5.75	3.3 0.13	196.0 7.72	362.9	68.5	0.1338	17.45 38.46
74512D	74850	1.5 0.06	146.0 5.75	3.3 0.13	196.0 7.72	362.9	68.5	0.1338	14.97 32.97
67390D	67322	1.5 0.06	145.0 5.71	3.3 0.13	180.0 7.09	383.7	70.1	0.1220	9.73 21.45

⁽⁴⁾These maximum fillet radii will be cleared by bearing corners.
NOTE: For spacer configuration information, contact your Timken engineer.

TAPERED ROLLER BEARINGS

DOUBLE-ROW • TYPE TDI

TYPE TDI



Bearing Dimensions				Load Ratings							
Bore d	O.D. D	Width T	Double Inner Ring Width B	Dynamic ⁽¹⁾				Dynamic ⁽³⁾			
				C ₁₍₂₎	e	Y ₁	Y ₂	C ₉₀	C _{a90}	C ₉₀₍₂₎	K
mm in.	mm in.	mm in.	mm in.	N lbf				N lbf	N lbf	N lbf	
136.525 5.3750	225.425 8.8750	120.650 4.7500	120.650 4.7500	1130000 253000	0.3	2.0	3.0	168000 37700	95500 21500	292000 65700	1.76
139.700 5.5000	200.025 7.8750	77.788 3.0625	75.408 2.9688	499000 112000	0.3	2.0	3.0	74300 16700	42800 9610	129000 29100	1.74
149.225 5.8750	236.538 9.3125	106.362 4.1875	105.346 4.1475	897000 202000	0.4	1.5	2.3	134000 30000	101000 22700	232000 52300	1.32
149.225 5.8750	241.300 9.5000	106.362 4.1875	105.346 4.1475	897000 202000	0.4	1.5	2.3	134000 30000	101000 22700	232000 52300	1.32
149.225 5.8750	254.000 10.0000	120.650 4.7500	120.650 4.7500	1150000 258000	0.4	1.7	2.5	171000 38500	119000 26800	298000 67000	1.43
152.400 6.0000	244.475 9.6250	87.312 3.4375	92.075 3.6250	699000 157000	0.4	1.9	2.9	104000 23400	62700 14100	181000 40800	1.66
155.575 6.1250	247.650 9.7500	122.238 4.8125	122.238 4.8125	1100000 248000	0.4	1.8	2.7	164000 36900	103000 23300	286000 64200	1.59
165.100 6.5000	225.425 8.8750	79.375 3.1250	76.200 3.0000	528000 119000	0.4	1.8	2.6	78600 17700	51600 11600	137000 30800	1.52
174.625 6.8750	288.925 11.3750	123.825 4.8750	123.825 4.8750	1430000 322000	0.3	2.1	3.2	214000 48000	117000 26200	372000 83600	1.83
177.800 7.0000	247.650 9.7500	90.488 3.5625	90.488 3.5625	705000 159000	0.4	1.5	2.3	105000 23600	79000 17800	183000 41100	1.33
177.800 7.0000	279.400 11.0000	112.710 4.4374	112.712 4.4375	930000 209000	0.5	1.3	1.9	138000 31100	124000 28000	241000 54200	1.11
177.800 7.0000	288.925 11.3750	123.825 4.8750	123.825 4.8750	1150000 258000	0.5	1.4	2.2	171000 38500	137000 30800	298000 67000	1.25
177.800 7.0000	288.925 11.3750	123.825 4.8750	123.825 4.8750	1430000 322000	0.3	2.1	3.2	214000 48000	117000 26200	372000 83600	1.83
177.800 7.0000	304.800 12.0000	109.438 4.3086	114.300 4.5000	1050000 236000	0.4	1.9	2.8	156000 35100	96400 21700	272000 61200	1.62
187.325 7.3750	319.964 12.5970	168.275 6.6250	161.925 6.3750	1830000 410000	0.3	2.1	3.2	272000 61100	148000 33400	473000 106000	1.83
187.325 7.3750	320.675 12.6250	168.275 6.6250	161.925 6.3750	1830000 410000	0.3	2.1	3.2	272000 61100	148000 33400	473000 106000	1.83
190.500 7.5000	317.500 12.5000	133.350 5.2500	133.350 5.2500	1270000 286000	0.5	1.3	1.9	190000 42600	170000 38200	330000 74200	1.12

⁽¹⁾Based on 1 x 10⁶ revolutions L₁₀ life, for the ISO life-calculation method. C₁₍₂₎ is the double-row radial value.

⁽²⁾Consult your Timken engineer for instructions on use or review the Timken Engineering Manual on timken.com/catalogs.

⁽³⁾Based on 90 x 10⁶ revolutions L₁₀ life, for The Timken Company life-calculation method. C₉₀ and C_{a90} are radial and thrust values for a single row. C₉₀₍₂₎ is the double-row radial value.

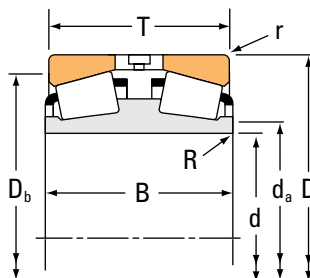
Part Number		Dimensions				Geometry Factors			Bearing Weight
Inner	Outer	Shaft		Housing		G ₁	G ₂	C _g	
		Max Shaft Fillet Radius R ⁽⁴⁾	Backing Shoulder Dia. d _a	Max Housing Fillet Radius r ⁽⁴⁾	Backing Shoulder Dia. D _b				
		mm in.	mm in.	mm in.	mm in.				kg lbs.
H228649D	H228610	1.5 0.06	152.0 5.98	3.3 0.13	203.0 7.99	539.6	76.7	0.1358	19.97 44.03
48680D	48620	0.8 0.03	150.0 5.91	3.3 0.13	185.0 7.28	439.6	130.5	0.1261	8.13 17.90
82587D	82931	1.5 0.06	165.0 6.50	3.3 0.13	213.0 8.39	460.5	81.1	0.1405	17.47 38.50
82587D	82950	1.5 0.06	165.0 6.50	3.3 0.13	215.0 8.46	460.5	81.1	0.1405	19.08 42.07
99587D	99100	1.5 0.06	167.0 6.57	3.3 0.13	227.0 8.94	555.5	73.5	0.1459	25.95 57.18
81601D	81962	1.5 0.06	166.1 6.54	3.3 0.13	225.0 8.86	413.0	98.4	0.1250	14.96 32.96
H432549D	H432510	1.5 0.06	172.0 6.77	3.3 0.13	224.0 8.82	657.5	97.8	0.1178	23.18 51.14
46790D	46720	0.8 0.03	175.0 6.89	3.3 0.13	209.0 8.23	572.0	174.7	0.1432	9.45 20.84
HM237542D	HM237510	1.5 0.06	191.0 7.52	3.3 0.13	266.0 10.47	751.2	101.5	0.1168	31.85 70.23
67790D	67720	1.5 0.06	190.0 7.48	3.3 0.13	229.0 9.02	622.3	122.6	0.1214	13.30 29.34
82680D	82620	1.5 0.06	197.0 7.76	3.3 0.13	251.0 9.88	661.2	119.5	0.1313	25.80 56.88
94706D	94113	1.5 0.06	195.0 7.68	3.3 0.13	259.0 10.20	692.3	93.9	0.1287	32.59 71.85
HM237546D	HM237510	1.5 0.06	194.0 7.64	3.3 0.13	266.0 10.47	751.2	101.5	0.1168	31.80 70.13
EE280700D	281200	3.3 0.13	199.9 7.87	3.3 0.13	279.0 10.98	591.3	86.0	0.1115	31.90 70.29
H239649D	H239610	3.3 0.13	209.0 8.23	4.8 0.19	293.0 11.54	905.7	90.3	0.1242	52.73 116.28
H239649D	H239612	3.3 0.13	209.0 8.23	4.8 0.19	293.0 11.54	905.7	90.3	0.1242	53.29 117.48
93751D	93125	6.4 0.25	222.0 8.74	3.3 0.13	286.0 11.26	912.5	126.1	0.1460	41.89 92.37

⁽⁴⁾These maximum fillet radii will be cleared by bearing corners.
NOTE: For spacer configuration information, contact your Timken engineer.

TAPERED ROLLER BEARINGS

DOUBLE-ROW • TYPE TDI

TYPE TDI



Bearing Dimensions				Load Ratings							
Bore d	O.D. D	Width T	Double Inner Ring Width B	Dynamic ⁽¹⁾				Dynamic ⁽³⁾			
				C ₁₍₂₎	e	Y ₁	Y ₂	C ₉₀	C _{a90}	C ₉₀₍₂₎	K
mm in.	mm in.	mm in.	mm in.	N lbf				N lbf	N lbf	N lbf	
190.500 7.5000	368.300 14.5000	158.750 6.2500	152.400 6.0000	1920000 432000	0.4	1.7	2.5	286000 64300	197000 44200	498000 112000	1.45
199.975 7.8730	317.500 12.5000	133.350 5.2500	133.350 5.2500	1270000 286000	0.5	1.3	1.9	190000 42600	170000 38200	330000 74200	1.12
203.200 8.0000	317.500 12.5000	123.825 4.8750	123.825 4.8750	1270000 286000	0.5	1.3	1.9	190000 42600	170000 38200	330000 74200	1.12
203.200 8.0000	317.500 12.5000	133.350 5.2500	133.350 5.2500	1270000 286000	0.5	1.3	1.9	190000 42600	170000 38200	330000 74200	1.12
203.200 8.0000	317.500 12.5000	142.875 5.6250	133.350 5.2500	1270000 286000	0.5	1.3	1.9	190000 42600	170000 38200	330000 74200	1.12
203.200 8.0000	365.049 14.3720	158.750 6.2500	152.400 6.0000	1920000 432000	0.4	1.7	2.5	286000 64300	197000 44200	498000 112000	1.45
203.275 8.0030	368.300 14.5000	158.750 6.2500	152.400 6.0000	1920000 432000	0.4	1.7	2.5	286000 64300	197000 44200	498000 112000	1.45
206.375 8.1250	282.575 11.1250	87.313 3.4375	87.312 3.4375	738000 166000	0.5	1.3	2.0	110000 24700	95800 21500	191000 43000	1.15
206.375 8.1250	336.550 13.2500	180.975 7.1250	184.150 7.2500	2360000 530000	0.3	2.0	3.0	351000 79000	200000 45000	612000 137000	1.76
215.900 8.5000	285.750 11.2500	85.725 3.3750	85.725 3.3750	748000 168000	0.5	1.4	2.1	111000 25000	91800 20600	194000 43600	1.21
215.900 8.5000	288.925 11.3750	85.725 3.3750	85.725 3.3750	748000 168000	0.5	1.4	2.1	111000 25000	91800 20600	194000 43600	1.21
215.900 8.5000	355.600 14.0000	120.650 4.7500	120.650 4.7500	1390000 312000	0.3	2.0	3.0	206000 46400	117000 26200	359000 80800	1.77
215.900 8.5000	355.600 14.0000	127.000 5.0000	130.175 5.1250	1320000 297000	0.6	1.1	1.7	197000 44200	199000 44700	343000 77000	0.99
219.075 8.6250	358.775 14.1250	196.850 7.7500	200.025 7.8750	2520000 566000	0.3	2.0	3.0	375000 84200	213000 47900	652000 147000	1.76
220.662 8.6875	314.325 12.3750	115.888 4.5625	115.888 4.5625	1210000 272000	0.3	2.0	3.0	180000 40500	103000 23100	314000 70500	1.76
225.425 8.8750	355.600 14.0000	120.650 4.7500	120.650 4.7500	1390000 312000	0.3	2.0	3.0	206000 46400	117000 26200	359000 80800	1.77
225.425 8.8750	355.600 14.0000	165.100 6.5000	165.100 6.5000	1390000 312000	0.3	2.0	3.0	206000 46400	117000 26200	359000 80800	1.77

⁽¹⁾Based on 1 x 10⁶ revolutions L₁₀ life, for the ISO life-calculation method. C₁₍₂₎ is the double-row radial value.

⁽²⁾Consult your Timken engineer for instructions on use or review the Timken Engineering Manual on timken.com/catalogs.

⁽³⁾Based on 90 x 10⁶ revolutions L₁₀ life, for The Timken Company life-calculation method. C₉₀ and C_{a90} are radial and thrust values for a single row. C₉₀₍₂₎ is the double-row radial value.

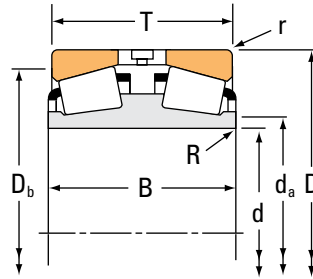
Part Number		Dimensions				Geometry Factors			Bearing Weight
Inner	Outer	Shaft		Housing		G ₁	G ₂	C _g	
		Max Shaft Fillet Radius R ⁽⁴⁾	Backing Shoulder Dia. d _a	Max Housing Fillet Radius r ⁽⁴⁾	Backing Shoulder Dia. D _b				kg lbs.
		mm in.	mm in.	mm in.	mm in.				
EE420750D	421450	3.3 0.13	221.0 8.70	3.3 0.13	331.0 13.03	1150.5	128.2	0.1450	76.87 169.49
93788D	93125	6.4 0.25	226.9 8.93	3.3 0.13	286.0 11.26	912.5	126.1	0.1460	40.08 88.39
93800D	93125	1.5 0.06	222.0 8.74	3.3 0.13	286.0 11.26	912.5	126.1	0.1460	42.54 93.81
93801D	93125	6.4 0.25	226.9 8.93	3.3 0.13	286.0 11.26	912.5	126.1	0.1460	37.25 82.13
93801D	93126	6.4 0.25	226.9 8.93	3.3 0.13	285.0 11.22	912.5	126.1	0.1460	38.99 85.94
EE420800D	421437	3.3 0.13	230.0 9.06	3.3 0.13	329.0 12.95	1150.5	128.2	0.1450	70.53 155.49
EE420804D	421450	3.3 0.13	231.0 9.09	3.3 0.13	331.0 13.03	1150.5	128.2	0.1450	71.12 156.80
67985D	67920	0.8 0.03	219.0 8.62	3.3 0.13	260.0 10.24	819.5	172.0	0.1388	16.43 36.26
H242649D	H242610	1.5 0.06	227.0 8.94	3.3 0.13	306.0 12.05	1404.1	134.8	0.1465	65.06 143.45
LM742749D	LM742710	0.8 0.03	227.0 8.94	3.3 0.13	266.0 10.47	866.9	225.2	0.1388	15.15 33.37
LM742749D	LM742714	0.8 0.03	227.0 8.94	3.3 0.13	267.0 10.51	866.9	225.2	0.1388	15.88 35.00
EE130850D	131400	1.5 0.06	237.0 9.33	1.5 0.06	329.0 12.95	1162.0	167.6	0.1358	46.68 102.93
96851D	96140	6.4 0.25	249.0 9.80	3.3 0.13	318.0 12.52	1140.0	160.6	0.1626	51.05 112.57
H244849D	H244810	1.5 0.06	242.0 9.53	6.4 0.25	323.0 12.72	1631.9	150.0	0.1540	81.11 178.83
M244249D	M244210	1.5 0.06	235.0 9.25	3.3 0.13	293.0 11.54	1149.7	141.4	0.1360	29.07 64.10
EE130887D	131400	5.5 0.22	252.0 9.92	1.5 0.06	329.0 12.95	1162.0	167.6	0.1358	43.70 96.35
EE130888D	131400	8.0 0.31	257.0 10.12	1.5 0.06	329.0 12.95	1162.0	167.6	0.1358	52.19 115.07

⁽⁴⁾These maximum fillet radii will be cleared by bearing corners.
NOTE: For spacer configuration information, contact your Timken engineer.

TAPERED ROLLER BEARINGS

DOUBLE-ROW • TYPE TDI

TYPE TDI



Bearing Dimensions				Load Ratings							
Bore d	O.D. D	Width T	Double Inner Ring Width B	Dynamic ⁽¹⁾				Dynamic ⁽³⁾			
				C ₁₍₂₎	e	Factors ⁽²⁾ Y ₁	Y ₂	C ₉₀	C _{a90}	C ₉₀₍₂₎	Factors ⁽²⁾ K
mm in.	mm in.	mm in.	mm in.	N lbf				N lbf	N lbf	N lbf	
228.600 9.0000	355.600 14.0000	120.650 4.7500	120.650 4.7500	1390000 312000	0.3	2.0	3.0	206000 46400	117000 26200	359000 80800	1.77
228.600 9.0000	355.600 14.0000	165.100 6.5000	165.100 6.5000	1390000 312000	0.3	2.0	3.0	206000 46400	117000 26200	359000 80800	1.77
228.600 9.0000	400.050 15.7500	158.750 6.2500	161.925 6.3750	1960000 440000	0.4	1.5	2.3	291000 65500	219000 49300	507000 114000	1.33
228.600 9.0000	425.450 16.7500	177.800 7.0000	165.100 6.5000	2700000 608000	0.3	2.0	3.0	402000 90500	229000 51500	701000 158000	1.76
228.600 9.0000	431.800 17.0000	158.749 6.2500	158.750 6.2500	2220000 499000	0.9	0.8	1.1	330000 74300	500000 112000	575000 129000	0.66
234.950 9.2500	327.025 12.8750	93.662 3.6875	93.662 3.6875	918000 206000	0.4	1.7	2.5	137000 30700	95200 21400	238000 53500	1.44
234.950 9.2500	384.175 15.1250	209.550 8.2500	209.550 8.2500	3090000 694000	0.3	2.0	3.0	460000 103000	262000 58800	800000 180000	1.76
241.225 9.4970	355.498 13.9960	107.950 4.2500	107.950 4.2500	1150000 258000	0.4	1.9	2.9	171000 38500	103000 23300	298000 67000	1.65
241.300 9.5000	419.100 16.5000	177.800 7.0000	174.625 6.8750	2650000 595000	0.4	1.6	2.4	394000 88600	281000 63100	686000 154000	1.40
241.478 9.5070	349.148 13.7460	107.950 4.2500	107.950 4.2500	1150000 258000	0.4	1.9	2.9	171000 38500	103000 23300	298000 67000	1.65
241.478 9.5070	355.498 13.9960	107.950 4.2500	107.950 4.2500	1150000 258000	0.4	1.9	2.9	171000 38500	103000 23300	298000 67000	1.65
241.478 9.5070	355.600 14.0000	107.950 4.2500	107.950 4.2500	1150000 258000	0.4	1.9	2.9	171000 38500	103000 23300	298000 67000	1.65
244.475 9.6250	327.025 12.8750	92.075 3.6250	92.075 3.6250	987000 222000	0.3	2.1	3.1	147000 33000	80800 18200	256000 57500	1.82
247.650 9.7500	406.400 16.0000	215.900 8.5000	219.075 8.6250	3420000 769000	0.3	2.0	3.0	509000 115000	290000 65200	887000 199000	1.76
254.000 10.0000	355.600 14.0000	92.710 3.6500	92.862 3.6560	976000 219000	0.4	1.9	2.8	145000 32700	90200 20300	253000 56900	1.61
254.000 10.0000	358.775 14.1250	130.175 5.1250	130.175 5.1250	1590000 358000	0.3	2.0	3.0	237000 53300	135000 30300	413000 92800	1.76
254.000 10.0000	360.000 14.1732	136.225 5.3632	130.175 5.1250	1590000 358000	0.3	2.0	3.0	237000 53300	135000 30300	413000 92800	1.76

⁽¹⁾Based on 1 x 10⁶ revolutions L₁₀ life, for the ISO life-calculation method. C₁₍₂₎ is the double-row radial value.

⁽²⁾Consult your Timken engineer for instructions on use or review the Timken Engineering Manual on timken.com/catalogs.

⁽³⁾Based on 90 x 10⁶ revolutions L₁₀ life, for The Timken Company life-calculation method. C₉₀ and C_{a90} are radial and thrust values for a single row. C₉₀₍₂₎ is the double-row radial value.

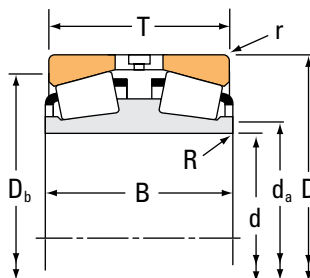
Part Number		Dimensions				Geometry Factors			Bearing Weight
Inner	Outer	Shaft		Housing		G ₁	G ₂	C _g	
		Max Shaft Fillet Radius R ⁽⁴⁾	Backing Shoulder Dia. d _a	Max Housing Fillet Radius r ⁽⁴⁾	Backing Shoulder Dia. D _b				
		mm in.	mm in.	mm in.	mm in.				kg lbs.
EE130900D	131400	1.5 0.06	247.0 9.72	1.5 0.06	329.0 12.95	1162.0	167.6	0.1358	43.45 95.81
EE130903D	131400	8.0 0.31	259.0 10.20	1.5 0.06	329.0 12.95	1162.0	167.6	0.1358	50.40 111.14
EE430901D	431575	3.3 0.13	250.7 9.87	3.3 0.13	360.0 14.17	1351.2	142.8	0.1572	81.54 179.79
EE700090D	700167	3.5 0.14	259.0 10.20	6.4 0.25	381.0 15.00	1488.7	109.7	0.1480	106.49 234.79
EE113090D	113170	6.4 0.25	271.5 10.69	6.4 0.25	375.0 14.76	966.7	98.1	0.1723	102.14 225.16
8576D	8520	1.5 0.06	250.0 9.84	3.3 0.13	305.0 12.01	1050.5	172.4	0.1401	24.86 54.82
H247549D	H247510	1.5 0.06	259.0 10.20	6.4 0.25	346.0 13.62	1964.4	148.4	0.1638	98.04 216.13
EE127094D	127138	1.5 0.06	257.0 10.12	3.3 0.13	327.0 12.87	1178.6	164.4	0.1392	36.78 81.09
EE821096D	821165	3.3 0.13	268.0 10.55	6.4 0.25	380.0 14.96	1493.2	126.1	0.1597	101.84 224.52
EE127097D	127135	1.5 0.06	258.0 10.16	3.3 0.13	325.0 12.80	1178.6	164.4	0.1392	33.77 74.43
EE127097D	127138	1.5 0.06	258.0 10.16	3.3 0.13	327.0 12.87	1178.6	164.4	0.1392	35.08 77.32
EE127097D	127140	1.5 0.06	258.0 10.16	3.3 0.13	327.0 12.87	1178.6	164.4	0.1392	35.12 77.41
LM247748D	LM247710	1.5 0.06	257.0 10.12	3.3 0.13	310.0 12.20	1173.3	243.9	0.1345	21.53 47.46
HH249949D	HH249910	3.3 0.13	278.0 10.94	6.4 0.25	366.0 14.41	2373.9	173.3	0.1746	120.05 264.65
EE171000D	171400	1.5 0.06	269.0 10.59	3.3 0.13	334.0 13.15	1068.6	171.6	0.1354	27.99 61.70
M249748D	M249710	3.3 0.13	272.5 10.73	3.3 0.13	335.0 13.19	1626.0	173.0	0.1526	42.34 93.34
M249748D	JM249712	3.3 0.13	272.5 10.73	3.0 0.12	336.0 13.23	1626.0	173.0	0.1526	44.36 97.78

⁽⁴⁾These maximum fillet radii will be cleared by bearing corners.
NOTE: For spacer configuration information, contact your Timken engineer.

TAPERED ROLLER BEARINGS

DOUBLE-ROW • TYPE TDI

TYPE TDI



Bearing Dimensions				Load Ratings							
Bore d	O.D. D	Width T	Double Inner Ring Width B	Dynamic ⁽¹⁾				Dynamic ⁽³⁾			
				C ₁₍₂₎	e	Y ₁	Y ₂	C ₉₀	C _{a90}	C ₉₀₍₂₎	K
mm in.	mm in.	mm in.	mm in.	N lbf				N lbf	N lbf	N lbf	
254.000 10.0000	365.049 14.3720	92.710 3.6500	92.862 3.6560	976000 219000	0.4	1.9	2.8	145000 32700	90200 20300	253000 56900	1.61
254.000 10.0000	368.300 14.5000	92.710 3.6500	92.862 3.6560	976000 219000	0.4	1.9	2.8	145000 32700	90200 20300	253000 56900	1.61
254.000 10.0000	422.275 16.6250	152.400 6.0000	139.700 5.5000	2610000 587000	0.3	2.0	3.0	389000 87400	221000 49700	677000 152000	1.76
254.000 10.0000	431.724 16.9970	145.258 5.7188	139.700 5.5000	2610000 587000	0.3	2.0	3.0	389000 87400	221000 49700	677000 152000	1.76
254.000 10.0000	438.150 17.2500	165.100 6.5000	165.100 6.5000	2470000 555000	0.4	1.9	2.8	368000 82700	226000 50700	640000 144000	1.63
254.000 10.0000	444.500 17.5000	133.350 5.2500	133.350 5.2500	2050000 460000	0.3	2.0	3.0	305000 68500	178000 40000	531000 119000	1.71
260.350 10.2500	365.125 14.3750	107.950 4.2500	107.950 4.2500	1180000 266000	0.4	1.8	2.7	176000 39600	113000 25400	307000 68900	1.56
260.350 10.2500	406.400 16.0000	155.575 6.1250	152.400 6.0000	2040000 459000	0.3	2.0	3.0	304000 68300	173000 39000	529000 119000	1.75
260.350 10.2500	419.100 16.5000	158.750 6.2500	155.575 6.1250	1960000 440000	0.6	1.1	1.7	291000 65500	302000 67800	507000 114000	0.97
260.350 10.2500	422.275 16.6250	152.400 6.0000	139.700 5.5000	2610000 587000	0.3	2.0	3.0	389000 87400	221000 49700	677000 152000	1.76
260.350 10.2500	431.724 16.9970	145.258 5.7188	139.700 5.5000	2610000 587000	0.3	2.0	3.0	389000 87400	221000 49700	677000 152000	1.76
260.350 10.2500	431.724 16.9970	148.433 5.8438	152.400 6.0000	2610000 587000	0.3	2.0	3.0	389000 87400	221000 49700	677000 152000	1.76
260.350 10.2500	444.500 17.5000	196.850 7.7500	196.850 7.7500	2810000 631000	0.6	1.2	1.8	418000 94000	391000 87800	728000 164000	1.07
266.700 10.5000	355.600 14.0000	107.950 4.2500	109.538 4.3125	1400000 315000	0.4	1.9	2.8	209000 46900	129000 28900	363000 81600	1.62
266.700 10.5000	393.700 15.5000	130.175 5.1250	130.175 5.1250	1540000 345000	0.4	1.7	2.5	229000 51400	157000 35400	398000 89600	1.45
266.700 10.5000	403.225 15.8750	122.240 4.8126	130.175 5.1250	1540000 345000	0.4	1.7	2.5	229000 51400	157000 35400	398000 89600	1.45
266.700 10.5000	406.400 16.0000	122.240 4.8126	130.175 5.1250	1540000 345000	0.4	1.7	2.5	229000 51400	157000 35400	398000 89600	1.45

⁽¹⁾Based on 1 x 10⁶ revolutions L₁₀ life, for the ISO life-calculation method. C₁₍₂₎ is the double-row radial value.

⁽²⁾Consult your Timken engineer for instructions on use or review the Timken Engineering Manual on timken.com/catalogs.

⁽³⁾Based on 90 x 10⁶ revolutions L₁₀ life, for The Timken Company life-calculation method. C₉₀ and C_{a90} are radial and thrust values for a single row. C₉₀₍₂₎ is the double-row radial value.

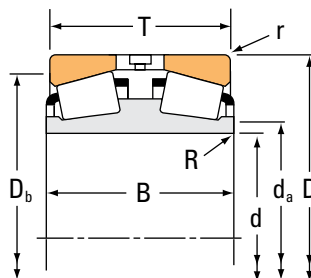
Part Number		Dimensions				Geometry Factors			Bearing Weight
Inner	Outer	Shaft		Housing		G ₁	G ₂	C _g	
		Max Shaft Fillet Radius R ⁽⁴⁾	Backing Shoulder Dia. d _a	Max Housing Fillet Radius r ⁽⁴⁾	Backing Shoulder Dia. D _b				
		mm in.	mm in.	mm in.	mm in.				kg lbs.
EE171000D	171436	1.5 0.06	269.0 10.59	3.3 0.13	338.0 13.31	1068.6	171.6	0.1354	30.85 68.02
EE171000D	171450	1.5 0.06	269.0 10.59	3.3 0.13	340.0 13.39	1068.6	171.6	0.1354	32.05 70.66
HM252343D	HM252310	3.5 0.14	281.0 11.06	3.3 0.13	392.0 15.43	1504.3	147.8	0.1482	81.05 178.65
HM252343D	HM252315	3.5 0.14	281.0 11.06	3.5 0.14	397.0 15.63	1504.3	147.8	0.1482	82.79 182.53
EE738101D	738172	3.3 0.13	284.0 11.18	6.4 0.25	401.1 15.79	1756.1	131.0	0.1601	105.97 233.61
EE822101D	822175	3.3 0.13	281.9 11.10	6.4 0.25	404.9 15.94	1363.4	186.1	0.1442	84.48 186.26
EE134102D	134143	3.3 0.13	280.0 11.02	6.4 0.25	339.0 13.35	1327.7	187.2	0.1474	33.76 74.46
EE324103D	324160	6.4 0.25	287.3 11.31	3.3 0.13	376.0 14.80	1736.8	222.5	0.1559	121.01 266.81
EE435103D	435165	3.3 0.13	289.0 11.38	3.3 0.13	376.0 14.80	1480.2	123.2	0.1787	80.70 177.89
HM252347D	HM252310	3.5 0.14	285.0 11.22	3.3 0.13	392.0 15.43	1504.3	147.8	0.1482	76.62 168.90
HM252347D	HM252315	3.5 0.14	285.0 11.22	3.5 0.14	397.0 15.63	1504.3	147.8	0.1482	79.98 176.34
HM252348D	HM252315	6.4 0.25	291.0 11.46	3.5 0.14	397.0 15.63	1504.3	147.8	0.1482	81.35 179.37
EE823103D	823175	6.4 0.25	295.5 11.63	3.3 0.13	399.0 15.71	1686.2	159.0	0.1813	119.46 263.37
LM451349D	LM451310	1.5 0.06	281.0 11.06	3.3 0.13	335.0 13.19	1554.1	212.2	0.1536	30.19 66.56
EE275106D	275155	3.3 0.13	290.0 11.42	6.4 0.25	366.0 14.41	1451.8	201.3	0.1555	49.03 108.10
EE275106D	275158	3.3 0.13	290.0 11.42	6.4 0.25	371.0 14.61	1451.8	201.3	0.1555	51.81 114.20
EE275106D	275160	3.3 0.13	290.0 11.42	6.4 0.25	373.0 14.69	1451.8	201.3	0.1555	53.51 117.97

⁽⁴⁾These maximum fillet radii will be cleared by bearing corners.
NOTE: For spacer configuration information, contact your Timken engineer.

TAPERED ROLLER BEARINGS

DOUBLE-ROW • TYPE TDI

TYPE TDI



Bearing Dimensions				Load Ratings							
Bore d	O.D. D	Width T	Double Inner Ring Width B	Dynamic ⁽¹⁾				Dynamic ⁽³⁾			
				C ₁₍₂₎	e	Factors ⁽²⁾ Y ₁	Y ₂	C ₉₀	C _{a90}	C ₉₀₍₂₎	Factors ⁽²⁾ K
mm in.	mm in.	mm in.	mm in.	N lbf				N lbf	N lbf	N lbf	
266.700 10.5000	488.950 19.2500	228.600 9.0000	238.125 9.3750	4220000 948000	0.3	2.2	3.2	628000 141000	336000 75600	1090000 246000	1.87
269.875 10.6250	381.000 15.0000	136.525 5.3750	136.525 5.3750	2000000 450000	0.3	2.0	3.0	298000 67000	170000 38100	519000 117000	1.76
276.225 10.8750	381.000 15.0000	95.250 3.7500	88.900 3.5000	806000 181000	0.6	1.2	1.7	120000 27000	120000 26900	209000 47000	1.00
276.225 10.8750	381.000 15.0000	111.125 4.3750	88.900 3.5000	806000 181000	0.6	1.2	1.7	120000 27000	120000 26900	209000 47000	1.00
276.225 10.8750	393.700 15.5000	130.175 5.1250	130.175 5.1250	1540000 345000	0.4	1.7	2.5	229000 51400	157000 35400	398000 89600	1.45
276.225 10.8750	403.225 15.8750	122.240 4.8126	130.175 5.1250	1540000 345000	0.4	1.7	2.5	229000 51400	157000 35400	398000 89600	1.45
279.400 11.0000	457.200 18.0000	244.475 9.6250	244.475 9.6250	4560000 1020000	0.3	2.0	3.0	679000 153000	386000 86800	1180000 266000	1.76
279.400 11.0000	469.900 18.5000	169.862 6.6875	166.688 6.5625	2810000 631000	0.4	1.8	2.7	418000 94000	271000 60800	728000 164000	1.55
279.578 11.0070	380.898 14.9960	117.475 4.6250	117.475 4.6250	1260000 283000	0.4	1.6	2.3	187000 42100	138000 31100	326000 73300	1.35
279.578 11.0070	381.000 15.0000	95.250 3.7500	88.900 3.5000	806000 181000	0.6	1.2	1.7	120000 27000	120000 26900	209000 47000	1.00
279.578 11.0070	381.000 15.0000	111.125 4.3750	88.900 3.5000	806000 181000	0.6	1.2	1.7	120000 27000	120000 26900	209000 47000	1.00
280.000 11.0236	409.981 16.1410	206.375 8.1250	206.375 8.1250	1610000 362000	0.4	1.8	2.6	240000 53900	158000 35600	417000 93800	1.51
288.925 11.3750	406.400 16.0000	144.462 5.6875	144.462 5.6875	2070000 466000	0.3	2.0	3.0	308000 69300	179000 40100	537000 121000	1.73
292.100 11.5000	422.275 16.6250	130.175 5.1250	130.175 5.1250	1890000 426000	0.3	2.1	3.1	282000 63400	154000 34700	491000 110000	1.83
292.100 11.5000	469.900 18.5000	138.928 5.4696	142.875 5.6250	2630000 591000	0.3	2.3	3.4	391000 88000	196000 44000	681000 153000	2.00
292.100 11.5000	476.250 18.7500	138.928 5.4696	142.875 5.6250	2630000 591000	0.3	2.3	3.4	391000 88000	196000 44000	681000 153000	2.00
298.450 11.7500	438.048 17.2460	131.762 5.1875	131.762 5.1875	1880000 422000	0.3	2.0	3.0	280000 62900	159000 35700	487000 110000	1.76

⁽¹⁾Based on 1 x 10⁶ revolutions L₁₀ life, for the ISO life-calculation method. C₁₍₂₎ is the double-row radial value.

⁽²⁾Consult your Timken engineer for instructions on use or review the Timken Engineering Manual on timken.com/catalogs.

⁽³⁾Based on 90 x 10⁶ revolutions L₁₀ life, for The Timken Company life-calculation method. C₉₀ and C_{a90} are radial and thrust values for a single row. C₉₀₍₂₎ is the double-row radial value.

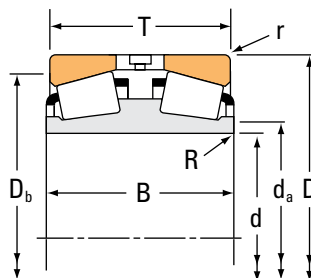
Part Number		Dimensions				Geometry Factors			Bearing Weight
Inner	Outer	Shaft		Housing		G ₁	G ₂	C _g	
		Max Shaft Fillet Radius R ⁽⁴⁾	Backing Shoulder Dia. d _a	Max Housing Fillet Radius r ⁽⁴⁾	Backing Shoulder Dia. D _b				
		mm in.	mm in.	mm in.	mm in.				kg lbs.
EE295106D	295193	6.4 0.25	304.0 11.97	6.4 0.25	444.0 17.48	2247.3	171.9	0.1664	184.42 406.60
M252349D	M252310	3.3 0.13	290.0 11.42	3.3 0.13	356.0 14.02	1839.2	226.1	0.1588	49.93 110.07
89108D	89148	3.3 0.13	297.0 11.69	3.3 0.13	354.0 13.94	1111.9	274.1	0.1586	29.21 64.38
89108D	89150	3.3 0.13	297.0 11.69	6.4 0.25	348.0 13.70	1111.9	274.1	0.1586	32.47 71.59
EE275109D	275155	1.5 0.06	293.6 11.56	6.4 0.25	366.0 14.41	1451.8	201.3	0.1555	49.79 109.79
EE275109D	275158	1.5 0.06	293.6 11.56	6.4 0.25	371.0 14.61	1451.8	201.3	0.1555	51.43 113.36
HH255149D	HH255110	1.5 0.06	309.0 12.17	6.4 0.25	412.0 16.22	3174.6	193.1	0.1922	169.04 372.70
EE722111D	722185	6.4 0.25	314.0 12.36	3.3 0.13	430.0 16.93	1894.4	142.6	0.1669	114.93 253.34
LM654644D	LM654610	1.5 0.06	297.0 11.69	3.3 0.13	356.0 14.02	1916.4	265.6	0.1744	40.56 89.44
89111D	89148	3.3 0.13	299.0 11.77	3.3 0.13	354.0 13.94	1111.9	274.1	0.1586	28.21 62.16
89111D	89150	3.3 0.13	299.0 11.77	6.4 0.25	348.0 13.70	1111.9	274.1	0.1586	31.47 69.37
EE128114D	128161	3.3 0.13	302.0 11.89	3.3 0.13	379.0 14.92	1727.7	255.2	0.1628	83.02 183.02
M255449D	M255410	3.3 0.13	310.0 12.20	3.3 0.13	379.0 14.92	2301.3	287.6	0.1722	60.77 134.00
EE330116D	330166	6.4 0.25	314.2 12.37	3.3 0.13	395.0 15.55	1950.7	301.9	0.1594	61.13 134.78
EE921150D	921850	1.5 0.06	314.0 12.36	3.3 0.13	439.0 17.28	1732.1	200.0	0.1481	88.34 194.78
EE921150D	921875	1.5 0.06	314.0 12.36	3.3 0.13	442.0 17.40	1732.1	200.0	0.1481	92.56 204.07
EE329118D	329172	3.3 0.13	323.0 12.72	3.3 0.13	410.0 16.14	2051.2	257.0	0.1638	64.02 141.15

⁽⁴⁾These maximum fillet radii will be cleared by bearing corners.
NOTE: For spacer configuration information, contact your Timken engineer.

TAPERED ROLLER BEARINGS

DOUBLE-ROW • TYPE TDI

TYPE TDI



Bearing Dimensions				Load Ratings							
Bore d	O.D. D	Width T	Double Inner Ring Width B	Dynamic ⁽¹⁾				Dynamic ⁽³⁾			
				C ₁₍₂₎	e	Y ₁	Y ₂	C ₉₀	C _{a90}	C ₉₀₍₂₎	K
mm in.	mm in.	mm in.	mm in.	N lbf				N lbf	N lbf	N lbf	
298.450 11.7500	444.500 17.5000	111.125 4.3750	107.950 4.2500	1540000 347000	0.4	1.8	2.7	230000 51700	149000 33400	400000 90000	1.55
299.975 11.8100	439.948 17.3208	133.350 5.2500	134.938 5.3125	1560000 351000	0.4	1.6	2.4	232000 52200	165000 37200	405000 91000	1.40
300.000 11.8110	460.000 18.1102	160.000 6.2992	160.000 6.2992	2920000 656000	0.3	2.0	3.0	435000 97800	249000 56000	757000 170000	1.74
300.038 11.8125	422.275 16.6250	150.812 5.9375	150.812 5.9375	2260000 508000	0.3	2.0	3.0	336000 75600	194000 43600	586000 132000	1.73
300.038 11.8125	422.275 16.6250	150.812 5.9375	150.812 5.9375	2260000 508000	0.3	2.0	3.0	336000 75600	194000 43600	586000 132000	1.73
303.212 11.9375	495.300 19.5000	263.525 10.3750	263.525 10.3750	5000000 1120000	0.3	2.0	3.0	744000 167000	423000 95200	1300000 291000	1.76
304.648 11.9940	438.048 17.2460	131.762 5.1875	131.762 5.1875	1920000 432000	0.3	2.0	3.0	286000 64300	162000 36500	498000 112000	1.76
304.648 11.9940	438.048 17.2460	133.350 5.2500	134.938 5.3125	1560000 351000	0.4	1.6	2.4	232000 52200	165000 37200	405000 91000	1.40
304.648 11.9940	438.048 17.2460	138.112 5.4375	128.588 5.0625	1910000 430000	0.5	1.4	2.1	285000 64000	231000 51800	496000 111000	1.24
304.800 12.0000	419.100 16.5000	130.175 5.1250	130.175 5.1250	2080000 468000	0.3	2.0	3.0	310000 69700	176000 39700	540000 121000	1.76
304.800 12.0000	444.500 17.5000	111.125 4.3750	107.950 4.2500	1540000 347000	0.4	1.8	2.7	230000 51700	149000 33400	400000 90000	1.55
304.800 12.0000	444.500 17.5000	111.125 4.3750	107.950 4.2500	1540000 347000	0.4	1.8	2.7	230000 51700	149000 33400	400000 90000	1.55
304.800 12.0000	495.300 19.5000	171.450 6.7500	165.100 6.5000	2940000 660000	0.4	1.7	2.5	437000 98300	301000 67700	762000 171000	1.45
304.800 12.0000	501.650 19.7500	161.925 6.3750	161.925 6.3750	3120000 702000	0.3	2.0	3.0	465000 105000	265000 59500	809000 182000	1.76
304.800 12.0000	558.800 22.0000	285.750 11.2500	285.750 11.2500	5390000 1210000	0.4	1.7	2.5	802000 180000	542000 122000	1400000 314000	1.48
304.902 12.0040	412.648 16.2460	128.588 5.0625	128.588 5.0625	1940000 437000	0.3	2.1	3.2	289000 65000	158000 35500	504000 113000	1.83
304.902 12.0040	438.048 17.2460	196.850 7.7500	212.725 8.3750	1560000 351000	0.4	1.6	2.4	232000 52200	165000 37200	405000 91000	1.40

⁽¹⁾Based on 1 x 10⁶ revolutions L₁₀ life, for the ISO life-calculation method. C₁₍₂₎ is the double-row radial value.

⁽²⁾Consult your Timken engineer for instructions on use or review the Timken Engineering Manual on timken.com/catalogs.

⁽³⁾Based on 90 x 10⁶ revolutions L₁₀ life, for The Timken Company life-calculation method. C₉₀ and C_{a90} are radial and thrust values for a single row. C₉₀₍₂₎ is the double-row radial value.

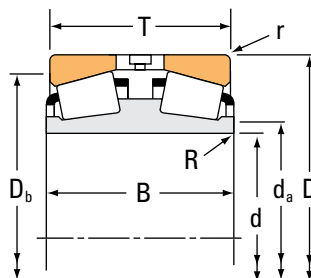
Part Number		Dimensions				Geometry Factors			Bearing Weight
Inner	Outer	Shaft		Housing		G ₁	G ₂	C _g	
		Max Shaft Fillet Radius R ⁽⁴⁾	Backing Shoulder Dia. d _a	Max Housing Fillet Radius r ⁽⁴⁾	Backing Shoulder Dia. D _b				
		mm in.	mm in.	mm in.	mm in.				kg lbs.
EE291176D	291750	8.0 0.31	332.0 13.07	1.5 0.06	416.0 16.38	1579.2	244.8	0.1557	54.57 120.32
EE129119D	129174	3.3 0.13	324.0 12.76	4.8 0.19	407.0 16.02	1882.6	272.9	0.1711	67.14 148.02
NP741064	NP034947	4.0 0.16	340.0 13.39	4.0 0.16	423.0 16.65	2944.6	303.9	0.1863	104.21 229.75
HM256849DA	HM256810	6.4 0.25	324.7 12.79	3.3 0.13	394.0 15.51	2548.4	281.8	0.1779	67.50 148.82
HM256849D	HM256810	3.3 0.13	322.0 12.68	3.3 0.13	394.0 15.51	2548.4	281.8	0.1779	69.57 153.37
HH258249D	HH258210	3.3 0.13	339.0 13.35	6.4 0.25	448.0 17.64	3853.2	220.0	0.2048	213.93 471.64
EE329117D	329172	3.3 0.13	327.0 12.87	3.3 0.13	410.0 16.14	2095.9	262.4	0.1651	64.30 141.77
EE129121D	129172	3.3 0.13	327.0 12.87	4.8 0.19	406.0 15.98	1882.6	272.9	0.1711	60.89 134.22
M757447D	M757410	3.3 0.13	328.0 12.91	4.8 0.19	407.0 16.02	1841.4	253.5	0.1775	64.10 141.35
M257149D	M257110	1.5 0.06	322.0 12.68	6.4 0.25	392.0 15.43	2157.5	303.6	0.1669	52.61 115.99
EE291200D	291750	8.0 0.31	337.0 13.27	1.5 0.06	416.0 16.38	1579.2	244.8	0.1557	52.03 114.71
EE291200D	291749	8.0 0.31	337.0 13.27	3.3 0.13	415.0 16.34	1579.2	244.8	0.1557	55.22 121.75
EE724121D	724195	3.3 0.13	334.0 13.15	6.4 0.25	450.0 17.72	2183.9	165.7	0.1783	125.31 276.25
HM258949D	HM258910	3.3 0.13	332.0 13.07	6.4 0.25	464.0 18.27	2160.7	183.0	0.1669	130.56 287.86
EE790119D	790221	3.3 0.13	339.0 13.35	6.4 0.25	501.0 19.72	2663.9	170.3	0.1898	296.99 654.78
M257248D	M257210	3.3 0.13	325.0 12.80	3.3 0.13	388.0 15.28	2336.4	320.3	0.1690	50.79 112.00
EE129124D	129172	3.3 0.13	328.0 12.91	4.8 0.19	406.0 15.98	1882.6	272.9	0.1711	87.48 192.84

⁽⁴⁾These maximum fillet radii will be cleared by bearing corners.
NOTE: For spacer configuration information, contact your Timken engineer.

TAPERED ROLLER BEARINGS

DOUBLE-ROW • TYPE TDI

TYPE TDI



Bearing Dimensions				Load Ratings							
Bore d	O.D. D	Width T	Double Inner Ring Width B	Dynamic ⁽¹⁾				Dynamic ⁽³⁾			
				C ₁₍₂₎	e	Y ₁	Y ₂	C ₉₀	C _{a90}	C ₉₀₍₂₎	K
mm in.	mm in.	mm in.	mm in.	N lbf				N lbf	N lbf	N lbf	
305.000 12.0079	438.048 17.2460	133.350 5.2500	134.938 5.3125	1560000 351000	0.4	1.6	2.4	232000 52200	165000 37200	405000 91000	1.40
305.000 12.0079	559.867 22.0420	170.434 6.7100	169.977 6.6920	2690000 605000	0.9	0.8	1.2	401000 90100	594000 134000	698000 157000	0.67
305.054 12.0100	499.948 19.6830	200.000 7.8740	200.000 7.8740	3360000 756000	0.5	1.4	2.0	501000 113000	424000 95400	872000 196000	1.18
317.500 12.5000	422.275 16.6250	128.588 5.0625	128.588 5.0625	1720000 386000	0.3	2.1	3.2	256000 57500	140000 31400	445000 100000	1.83
317.500 12.5000	447.675 17.6250	158.750 6.2500	158.750 6.2500	2920000 656000	0.3	2.0	3.0	435000 97800	249000 56000	757000 170000	1.74
330.200 13.0000	414.338 16.3125	76.200 3.0000	76.200 3.0000	899000 202000	0.3	2.0	3.0	134000 30100	76200 17100	233000 52400	1.76
330.200 13.0000	482.600 19.0000	152.400 6.0000	147.638 5.8125	2180000 489000	0.4	1.7	2.6	324000 72900	217000 48700	564000 127000	1.49
330.302 13.0040	438.023 17.2450	120.650 4.7500	114.300 4.5000	1280000 287000	0.5	1.5	2.2	190000 42800	149000 33600	331000 74500	1.27
333.375 13.1250	469.900 18.5000	166.688 6.5625	166.688 6.5625	2780000 626000	0.3	2.0	3.0	415000 93200	238000 53400	722000 162000	1.74
340.000 13.3858	460.000 18.1102	118.364 4.6600	118.000 4.6457	1280000 287000	0.3	2.2	3.3	190000 42700	100000 22500	331000 74400	1.90
342.900 13.5000	533.400 21.0000	139.700 5.5000	146.050 5.7500	3010000 676000	0.3	2.0	3.0	448000 101000	255000 57300	780000 175000	1.76
343.052 13.5060	457.098 17.9960	120.650 4.7500	120.650 4.7500	1210000 273000	0.5	1.4	2.1	181000 40700	149000 33400	315000 70800	1.22
343.052 13.5060	457.098 17.9960	122.238 4.8125	122.238 4.8125	1590000 358000	0.5	1.4	2.1	237000 53400	192000 43200	413000 92900	1.24
343.052 13.5060	457.098 17.9960	123.825 4.8750	122.238 4.8125	1430000 322000	0.7	1.0	1.4	213000 48000	260000 58500	371000 83500	0.82
346.075 13.6250	469.900 18.5000	104.775 4.1250	95.250 3.7500	954000 214000	0.5	1.4	2.0	142000 31900	122000 27400	247000 55600	1.17
346.075 13.6250	482.600 19.0000	104.775 4.1250	95.250 3.7500	954000 214000	0.5	1.4	2.0	142000 31900	122000 27400	247000 55600	1.17
346.075 13.6250	488.950 19.2500	104.775 4.1250	95.250 3.7500	954000 214000	0.5	1.4	2.0	142000 31900	122000 27400	247000 55600	1.17

⁽¹⁾Based on 1 x 10⁶ revolutions L₁₀ life, for the ISO life-calculation method. C₁₍₂₎ is the double-row radial value.

⁽²⁾Consult your Timken engineer for instructions on use or review the Timken Engineering Manual on timken.com/catalogs.

⁽³⁾Based on 90 x 10⁶ revolutions L₁₀ life, for The Timken Company life-calculation method. C₉₀ and C_{a90} are radial and thrust values for a single row. C₉₀₍₂₎ is the double-row radial value.

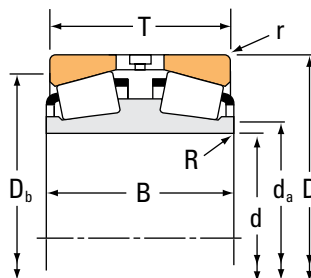
Part Number		Dimensions				Geometry Factors			Bearing Weight
Inner	Outer	Shaft		Housing		G ₁	G ₂	C _g	
		Max Shaft Fillet Radius R ⁽⁴⁾	Backing Shoulder Dia. d _a	Max Housing Fillet Radius r ⁽⁴⁾	Backing Shoulder Dia. D _b				kg lbs.
		mm in.	mm in.	mm in.	mm in.				
EE129123D	129172	3.3 0.13	328.0 12.91	4.8 0.19	406.0 15.98	1882.6	272.9	0.1711	60.71 133.83
HM959649D	HM959618	3.3 0.13	345.9 13.62	4.8 0.19	485.0 19.09	1749.6	156.7	0.2084	181.92 401.07
HM858548D	HM858511	3.3 0.13	337.0 13.27	6.4 0.25	453.9 17.87	2310.5	179.9	0.1949	152.93 337.19
LM258649D	LM258610	1.5 0.06	333.3 13.12	3.3 0.13	398.0 15.67	2549.1	293.5	0.1739	48.23 106.32
HM259049D	HM259010	3.3 0.13	340.0 13.39	3.3 0.13	418.0 16.46	2944.6	303.9	0.1863	82.41 181.69
L259749D	L259710	1.5 0.06	343.0 13.50	3.3 0.13	398.0 15.67	1635.6	422.9	0.1502	23.77 52.43
EE526131D	526190	1.5 0.06	351.0 13.82	3.3 0.13	449.0 17.68	2283.3	287.2	0.1790	83.06 183.13
EE138131D	138172	1.5 0.06	347.0 13.66	3.3 0.13	412.0 16.22	1974.6	290.4	0.1786	46.18 101.82
HM261049D	HM261010	3.3 0.13	357.0 14.06	3.3 0.13	439.0 17.28	3306.8	324.3	0.1935	95.39 210.29
JL163142D	JL163115	3.5 0.14	363.0 14.29	3.5 0.14	430.0 16.93	3207.7	621.3	0.1838	60.72 133.89
EE971355D	972100	3.3 0.13	370.0 14.57	3.3 0.13	501.0 19.72	2433.2	282.5	0.1730	113.46 250.13
EE133136D	133180	1.5 0.06	361.0 14.21	3.3 0.13	430.0 16.93	2053.9	306.0	0.1831	52.30 115.32
LM761649D	LM761610	1.5 0.06	361.0 14.21	3.3 0.13	432.0 17.01	2200.4	322.3	0.1873	51.91 114.44
LM961548D	LM961511	1.5 0.06	362.0 14.25	3.3 0.13	423.0 16.65	2281.5	300.4	0.2146	55.81 123.04
EE161362D	161850	1.5 0.06	368.0 14.49	6.4 0.25	445.0 17.52	1730.8	299.6	0.1741	45.81 101.01
EE161362D	161900	1.5 0.06	368.0 14.49	6.4 0.25	451.0 17.76	1730.8	299.6	0.1741	51.47 113.46
EE161362D	161925	1.5 0.06	368.0 14.49	6.4 0.25	453.0 17.83	1730.8	299.6	0.1741	54.35 119.81

⁽⁴⁾These maximum fillet radii will be cleared by bearing corners.
NOTE: For spacer configuration information, contact your Timken engineer.

TAPERED ROLLER BEARINGS

DOUBLE-ROW • TYPE TDI

TYPE TDI



Bearing Dimensions				Load Ratings							
Bore d	O.D. D	Width T	Double Inner Ring Width B	Dynamic ⁽¹⁾				Dynamic ⁽³⁾			
				C ₁₍₂₎	e	Y ₁	Y ₂	C ₉₀	C _{a90}	C ₉₀₍₂₎	K
mm in.	mm in.	mm in.	mm in.	N lbf				N lbf	N lbf	N lbf	
346.075 13.6250	488.950 19.2500	174.625 6.8750	174.625 6.8750	3010000 676000	0.3	2.0	3.0	448000 101000	257000 57700	780000 175000	1.74
347.662 13.6875	469.900 18.5000	138.112 5.4375	138.112 5.4375	2730000 614000	0.3	2.0	3.0	406000 91400	231000 52000	708000 159000	1.76
355.600 14.0000	444.500 17.5000	112.712 4.4375	114.300 4.5000	1280000 287000	0.3	2.2	3.3	190000 42700	100000 22500	331000 74400	1.90
355.600 14.0000	457.200 18.0000	120.650 4.7500	120.650 4.7500	1640000 368000	0.3	2.1	3.2	244000 54900	133000 29900	425000 95500	1.83
355.600 14.0000	458.470 18.0500	120.650 4.7500	120.650 4.7500	1640000 368000	0.3	2.1	3.2	244000 54900	133000 29900	425000 95500	1.83
355.600 14.0000	482.600 19.0000	133.350 5.2500	128.588 5.0625	1870000 420000	0.5	1.4	2.1	278000 62500	225000 50600	484000 109000	1.24
355.600 14.0000	488.950 19.2500	153.988 6.0625	153.988 6.0625	2630000 591000	0.3	2.0	3.0	391000 88000	223000 50100	681000 153000	1.76
355.600 14.0000	501.650 19.7500	127.000 5.0000	111.125 4.3750	1830000 412000	0.4	1.5	2.3	273000 61300	206000 46200	475000 107000	1.33
355.600 14.0000	514.350 20.2500	127.000 5.0000	111.125 4.3750	1830000 412000	0.4	1.5	2.3	273000 61300	206000 46200	475000 107000	1.33
356.387 14.0310	482.600 19.0000	104.775 4.1250	101.600 4.0000	954000 214000	0.5	1.4	2.0	142000 31900	122000 27400	247000 55600	1.17
368.300 14.5000	523.875 20.6250	185.738 7.3125	185.738 7.3125	3960000 890000	0.3	2.0	3.0	589000 132000	335000 75400	1030000 231000	1.76
368.300 14.5000	596.900 23.5000	165.100 6.5000	158.750 6.2500	3090000 694000	0.4	1.6	2.4	460000 103000	326000 73400	801000 180000	1.41
368.300 14.5000	609.600 24.0000	254.000 10.0000	279.400 11.0000	5170000 1160000	0.4	1.9	2.8	770000 173000	470000 106000	1340000 301000	1.64
368.300 14.5000	622.300 24.5000	254.000 10.0000	279.400 11.0000	5170000 1160000	0.4	1.9	2.8	770000 173000	470000 106000	1340000 301000	1.64
374.574 14.7470	546.100 21.5000	193.675 7.6250	193.675 7.6250	4290000 963000	0.3	2.0	3.0	638000 143000	363000 81700	1110000 250000	1.76
374.650 14.7500	501.650 19.7500	127.000 5.0000	117.475 4.6250	1830000 412000	0.4	1.5	2.3	273000 61300	206000 46200	475000 107000	1.33
374.650 14.7500	501.650 19.7500	130.175 5.1250	120.650 4.7500	1860000 417000	0.5	1.4	2.1	276000 62100	224000 50300	481000 108000	1.24

⁽¹⁾Based on 1 x 10⁶ revolutions L₁₀ life, for the ISO life-calculation method. C₁₍₂₎ is the double-row radial value.

⁽²⁾Consult your Timken engineer for instructions on use or review the Timken Engineering Manual on timken.com/catalogs.

⁽³⁾Based on 90 x 10⁶ revolutions L₁₀ life, for The Timken Company life-calculation method. C₉₀ and C_{a90} are radial and thrust values for a single row. C₉₀₍₂₎ is the double-row radial value.

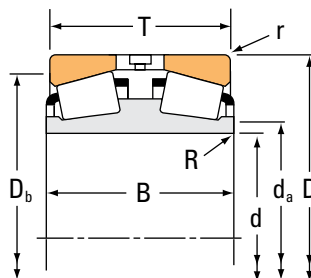
Part Number		Dimensions				Geometry Factors			Bearing Weight
Inner	Outer	Shaft		Housing		G ₁	G ₂	C _g	
		Max Shaft Fillet Radius R ⁽⁴⁾	Backing Shoulder Dia. d _a	Max Housing Fillet Radius r ⁽⁴⁾	Backing Shoulder Dia. D _b				
		mm in.	mm in.	mm in.	mm in.				kg lbs.
HM262749D	HM262710	3.3 0.13	371.0 14.61	3.3 0.13	456.0 17.95	3646.2	341.8	0.1999	110.26 243.09
M262449D	M262410	3.3 0.13	369.0 14.53	3.3 0.13	443.0 17.44	2968.5	408.3	0.1853	69.19 152.55
L163149D	L163110	1.5 0.06	370.0 14.57	3.3 0.13	422.0 16.61	3207.7	621.3	0.1838	40.80 89.95
LM263149D	LM263110	1.5 0.06	372.0 14.65	3.3 0.13	434.0 17.09	3094.1	470.9	0.1845	50.40 111.09
LM263149D	LM263112	1.5 0.06	372.0 14.65	3.3 0.13	435.0 17.13	3094.1	470.9	0.1845	51.16 112.79
LM763449D	LM763410	1.5 0.06	375.0 14.76	3.3 0.13	453.0 17.83	2495.3	327.3	0.1955	66.45 146.49
M263349D	M263310	1.5 0.06	374.0 14.72	3.3 0.13	459.0 18.07	3301.0	337.7	0.1924	87.63 193.15
EE231401D	231975	3.3 0.13	382.0 15.04	3.3 0.13	472.0 18.58	2386.0	366.8	0.1874	70.62 155.70
EE231401D	232025	3.3 0.13	382.0 15.04	3.3 0.13	478.0 18.82	2386.0	366.8	0.1874	78.56 173.17
EE161403D	161900	1.5 0.06	375.0 14.76	6.4 0.25	451.0 17.76	1730.8	299.6	0.1741	48.59 107.11
HM265049D	HM265010	3.3 0.13	394.0 15.50	6.4 0.25	487.0 19.17	4297.3	412.9	0.2106	131.80 290.56
EE181454D	182350	6.4 0.25	408.0 16.06	6.4 0.25	552.0 21.73	2961.8	271.9	0.1984	165.60 365.08
EE321146D	321240	3.3 0.13	404.0 15.91	6.4 0.25	555.0 21.85	4401.5	304.6	0.2173	301.00 663.61
EE321146D	321245	3.3 0.13	404.0 15.91	6.4 0.25	561.0 22.09	4401.5	304.6	0.2173	332.56 733.20
HM266445D	HM266410	3.3 0.13	404.0 15.91	6.4 0.25	507.0 19.96	4760.1	301.5	0.2178	159.35 351.30
EE231475D	231975	1.5 0.06	393.0 15.47	3.3 0.13	472.0 18.58	2386.0	366.8	0.1874	62.17 137.07
LM765149D	LM765110	1.5 0.06	393.0 15.47	3.3 0.13	472.0 18.58	2574.9	352.2	0.1972	66.95 147.60

⁽⁴⁾These maximum fillet radii will be cleared by bearing corners.
NOTE: For spacer configuration information, contact your Timken engineer.

TAPERED ROLLER BEARINGS

DOUBLE-ROW • TYPE TDI

TYPE TDI



Bearing Dimensions				Load Ratings							
Bore d	O.D. D	Width T	Double Inner Ring Width B	Dynamic ⁽¹⁾				Dynamic ⁽³⁾			
				C ₁₍₂₎	e	Y ₁	Y ₂	C ₉₀	C _{a90}	C ₉₀₍₂₎	K
mm in.	mm in.	mm in.	mm in.	N lbf				N lbf	N lbf	N lbf	
374.650 14.7500	514.350 20.2500	127.000 5.0000	117.475 4.6250	1830000 412000	0.4	1.5	2.3	273000 61300	206000 46200	475000 107000	1.33
384.175 15.1250	546.100 21.5000	193.675 7.6250	193.675 7.6250	3660000 823000	0.3	2.0	3.0	545000 123000	311000 69800	950000 213000	1.76
384.175 15.1250	546.100 21.5000	193.675 7.6250	193.675 7.6250	3950000 887000	0.3	2.0	3.0	588000 132000	335000 75200	1020000 230000	1.76
393.700 15.5000	546.100 21.5000	138.112 5.4375	138.112 5.4375	2280000 513000	0.5	1.4	2.1	340000 76400	276000 62000	592000 133000	1.23
393.700 15.5000	558.800 22.0000	119.062 4.6875	120.650 4.7500	1890000 425000	0.5	1.4	2.1	282000 63300	230000 51600	490000 110000	1.23
406.400 16.0000	546.100 21.5000	87.312 3.4375	138.112 5.4375	2450000 551000	0.5	1.4	2.1	365000 82100	296000 66600	636000 143000	1.23
406.400 16.0000	546.100 21.5000	141.288 5.5625	120.650 4.7500	1890000 425000	0.5	1.4	2.1	282000 63300	230000 51600	490000 110000	1.23
406.400 16.0000	558.800 22.0000	119.062 4.6875	120.650 4.7500	1890000 425000	0.5	1.4	2.1	282000 63300	230000 51600	490000 110000	1.23
406.400 16.0000	558.800 22.0000	123.825 4.8750	120.650 4.7500	1890000 425000	0.5	1.4	2.1	282000 63300	230000 51600	490000 110000	1.23
406.400 16.0000	574.675 22.6250	114.300 4.5000	114.300 4.5000	1930000 434000	0.5	1.4	2.0	287000 64600	245000 55000	500000 112000	1.17
406.400 16.0000	590.550 23.2500	193.675 7.6250	193.675 7.6250	4020000 903000	0.3	2.1	3.1	598000 135000	333000 74900	1040000 234000	1.80
406.400 16.0000	609.600 24.0000	157.162 6.1875	149.225 5.8750	3210000 721000	0.4	1.8	2.6	477000 107000	313000 70400	831000 187000	1.52
409.575 16.1250	546.100 21.5000	161.925 6.3750	161.925 6.3750	2940000 661000	0.4	1.6	2.4	438000 98500	313000 70400	763000 171000	1.40
415.925 16.3750	590.550 23.2500	209.550 8.2500	209.550 8.2500	4970000 1120000	0.3	2.0	3.0	740000 166000	421000 94800	1290000 290000	1.76
419.227 16.5050	736.448 28.9940	406.400 16.0000	406.400 16.0000	10500000 2350000	0.4	1.8	2.7	1560000 350000	996000 224000	2710000 610000	1.56
425.450 16.7500	685.698 26.9960	253.873 9.9950	253.873 9.9950	5450000 1230000	0.4	1.7	2.5	812000 183000	559000 126000	1410000 318000	1.45
431.800 17.0000	571.500 22.5000	133.350 5.2500	130.175 5.1250	2420000 543000	0.4	1.8	2.6	360000 80900	237000 53300	626000 141000	1.52

⁽¹⁾Based on 1 x 10⁶ revolutions L₁₀ life, for the ISO life-calculation method. C₁₍₂₎ is the double-row radial value.

⁽²⁾Consult your Timken engineer for instructions on use or review the Timken Engineering Manual on timken.com/catalogs.

⁽³⁾Based on 90 x 10⁶ revolutions L₁₀ life, for The Timken Company life-calculation method. C₉₀ and C_{a90} are radial and thrust values for a single row. C₉₀₍₂₎ is the double-row radial value.

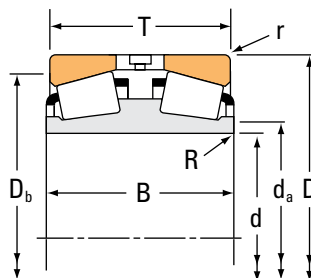
Part Number		Dimensions				Geometry Factors			Bearing Weight
Inner	Outer	Shaft		Housing		G ₁	G ₂	C _g	
		Max Shaft Fillet Radius R ⁽⁴⁾	Backing Shoulder Dia. d _a	Max Housing Fillet Radius r ⁽⁴⁾	Backing Shoulder Dia. D _b				
		mm in.	mm in.	mm in.	mm in.				kg lbs.
EE231475D	232025	1.5 0.06	393.0 15.47	3.3 0.13	478.0 18.82	2386.0	366.8	0.1874	70.11 154.54
HM266449D	HM266410	3.3 0.13	411.0 16.18	6.4 0.25	507.0 19.96	4760.1	301.5	0.2178	154.73 341.11
HM266448D	HM266410	3.3 0.13	411.0 16.18	6.4 0.25	507.0 19.96	4383.4	278.7	0.2116	147.14 324.40
LM767745D	LM767710	1.5 0.06	418.0 16.46	6.4 0.25	510.0 20.08	3387.8	464.9	0.2163	98.85 217.93
EE234157D	234220	3.3 0.13	420.0 16.54	6.4 0.25	516.0 20.31	2782.9	448.6	0.2018	95.27 210.04
LM767748D	LM767710	1.5 0.06	427.0 16.81	6.4 0.25	510.0 20.08	3640.2	497.8	0.2218	94.87 209.18
EE234161D	234215	1.5 0.06	425.0 16.73	6.4 0.25	504.0 19.84	2782.9	448.6	0.2018	82.24 181.31
EE234161D	234220	1.5 0.06	425.0 16.73	6.4 0.25	516.0 20.31	2782.9	448.6	0.2018	81.08 178.77
EE234161D	234220	1.5 0.06	425.0 16.73	6.4 0.25	516.0 20.31	2782.9	448.6	0.2018	81.08 193.39
EE285161D	285226	3.3 0.13	435.0 17.13	3.3 0.13	534.0 21.02	3036.6	478.1	0.2103	97.72 215.42
EE833161XD	833232	3.3 0.13	435.0 17.13	6.4 0.25	549.0 21.61	4955.5	446.0	0.2186	180.03 396.92
EE911603D	912400	3.5 0.14	437.0 17.20	6.4 0.25	567.0 22.32	3251.1	349.1	0.1990	148.41 327.24
M667947D	M667911	1.5 0.06	431.0 16.97	6.4 0.25	510.0 20.08	4197.4	453.5	0.2235	105.61 232.85
M268748D	M268710	9.7 0.38	451.9 17.79	6.4 0.25	548.9 21.61	5754.9	420.9	0.2319	189.52 417.80
EE323166D	323290	6.4 0.25	477.3 18.79	6.4 0.25	657.0 25.87	7958.6	331.3	0.2699	770.95 1699.62
EE328167D	328269	6.4 0.25	469.0 18.46	6.4 0.25	624.0 24.57	5606.6	353.0	0.2443	376.93 831.03
EE239171D	239225	1.5 0.06	449.1 17.68	3.3 0.13	540.0 21.26	4003.6	563.3	0.2131	93.15 205.37

⁽⁴⁾These maximum fillet radii will be cleared by bearing corners.
NOTE: For spacer configuration information, contact your Timken engineer.

TAPERED ROLLER BEARINGS

DOUBLE-ROW • TYPE TDI

TYPE TDI



Bearing Dimensions				Load Ratings							
Bore d	O.D. D	Width T	Double Inner Ring Width B	Dynamic ⁽¹⁾				Dynamic ⁽³⁾			
				C ₁₍₂₎	e	Y ₁	Y ₂	C ₉₀	C _{a90}	C ₉₀₍₂₎	K
mm in.	mm in.	mm in.	mm in.	N lbf				N lbf	N lbf	N lbf	
431.800 17.0000	571.500 22.5000	133.350 5.2500	130.175 5.1250	2420000 543000	0.4	1.8	2.6	360000 80900	237000 53300	626000 141000	1.52
431.800 17.0000	635.000 25.0000	173.038 6.8125	173.038 6.8125	3680000 827000	0.3	2.1	3.1	548000 123000	301000 67700	953000 214000	1.82
431.800 17.0000	723.900 28.5000	419.100 16.5000	419.100 16.5000	10700000 2400000	0.3	2.3	3.4	1590000 358000	807000 181000	2770000 623000	1.97
431.902 17.0040	685.698 26.9960	253.873 9.9950	253.873 9.9950	5450000 1230000	0.4	1.7	2.5	812000 183000	559000 126000	1410000 318000	1.45
431.902 17.0040	685.698 26.9960	330.200 13.0000	330.200 13.0000	8080000 1820000	0.3	2.1	3.1	1200000 270000	669000 150000	2090000 471000	1.80
432.003 17.0080	609.524 23.9970	152.400 6.0000	152.400 6.0000	2990000 673000	0.4	1.9	2.9	446000 100000	265000 59600	776000 175000	1.68
447.675 17.6250	635.000 25.0000	223.838 8.8125	223.838 8.8125	5700000 1280000	0.3	2.0	3.0	849000 191000	484000 109000	1480000 332000	1.76
449.948 17.7145	594.949 23.4232	178.000 7.0079	178.000 7.0079	3470000 780000	0.3	2.0	3.0	517000 116000	294000 66200	900000 202000	1.76
456.794 17.9840	761.873 29.9950	254.000 10.0000	254.000 10.0000	6180000 1390000	0.4	1.5	2.3	920000 207000	695000 156000	1600000 360000	1.32
457.073 17.9950	730.148 28.7460	203.200 8.0000	196.850 7.7500	4920000 1110000	0.4	1.7	2.6	733000 165000	492000 111000	1280000 287000	1.49
457.073 17.9950	749.300 29.5000	419.100 16.5000	412.750 16.2500	11000000 2480000	0.3	2.2	3.3	1640000 369000	858000 193000	2860000 643000	1.91
457.200 18.0000	596.900 23.5000	133.350 5.2500	130.175 5.1250	2460000 554000	0.4	1.7	2.5	367000 82400	254000 57100	639000 144000	1.44
457.200 18.0000	596.900 23.5000	136.525 5.3750	133.350 5.2500	2610000 587000	0.5	1.4	2.1	389000 87500	315000 70800	677000 152000	1.24
457.200 18.0000	660.400 26.0000	155.575 6.1250	155.575 6.1250	3070000 689000	0.4	1.8	2.7	457000 103000	292000 65700	795000 179000	1.56
457.200 18.0000	761.873 29.9950	215.900 8.5000	209.550 8.2500	6040000 1360000	0.3	2.1	3.2	900000 202000	491000 110000	1570000 352000	1.83
457.200 18.0000	812.800 32.0000	342.900 13.5000	342.900 13.5000	8610000 1940000	0.3	2.0	3.0	1280000 288000	738000 166000	2230000 502000	1.74
457.200 18.0000	863.498 33.9960	368.300 14.5000	368.300 14.5000	10800000 2420000	0.4	1.9	2.8	1600000 361000	989000 222000	2790000 628000	1.62

⁽¹⁾Based on 1 x 10⁶ revolutions L₁₀ life, for the ISO life-calculation method. C₁₍₂₎ is the double-row radial value.

⁽²⁾Consult your Timken engineer for instructions on use or review the Timken Engineering Manual on timken.com/catalogs.

⁽³⁾Based on 90 x 10⁶ revolutions L₁₀ life, for The Timken Company life-calculation method. C₉₀ and C_{a90} are radial and thrust values for a single row. C₉₀₍₂₎ is the double-row radial value.

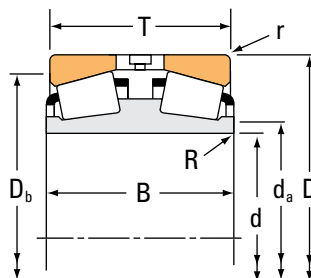
Part Number		Dimensions				Geometry Factors			Bearing Weight
Inner	Outer	Shaft		Housing		G ₁	G ₂	C _g	
		Max Shaft Fillet Radius R ⁽⁴⁾	Backing Shoulder Dia. d _a	Max Housing Fillet Radius r ⁽⁴⁾	Backing Shoulder Dia. D _b				kg lbs.
		mm in.	mm in.	mm in.	mm in.				
EE239173D	239225	1.5 0.06	449.1 17.68	3.3 0.13	540.0 21.26	4003.6	563.3	0.2131	93.62 206.41
EE931170D	931250	6.4 0.25	468.1 18.43	6.4 0.25	591.1 23.27	4624.1	391.2	0.2117	187.65 413.69
NP710048	NP102973	3.3 0.13	478.0 18.82	8.4 0.33	669.0 26.34	9649.5	361.5	0.2667	725.86 1600.22
EE328172D	328269	6.4 0.25	474.0 18.66	6.4 0.25	624.0 24.57	5606.6	353.0	0.2443	368.28 811.97
EE650171D	650270	5.0 0.20	479.0 18.86	6.4 0.25	627.0 24.69	7668.4	341.3	0.2542	487.03 1073.71
EE736173D	736238	3.5 0.14	459.0 18.07	6.4 0.25	570.0 22.44	4176.8	536.6	0.2096	138.77 305.93
M270749D	M270710	3.3 0.13	478.0 18.82	6.4 0.25	591.0 23.27	6865.6	481.9	0.2458	240.64 530.52
M270449DA	M270410	3.0 0.12	474.0 18.66	6.0 0.24	561.0 22.09	6018.9	562.1	0.2343	137.77 303.74
EE425176D	425299	3.3 0.13	500.0 19.69	6.4 0.25	696.0 27.40	5741.9	326.2	0.2529	463.65 1022.16
EE671798D	672873	1.5 0.06	491.0 19.33	6.4 0.25	675.0 26.57	4968.3	343.4	0.2315	331.41 730.64
EE925179D	925295	3.3 0.13	504.0 19.84	6.4 0.25	681.0 26.81	10435.5	423.0	0.2765	769.11 1695.62
EE244181D	244235	1.5 0.06	478.0 18.82	3.3 0.13	567.0 22.32	4411.8	627.1	0.2233	92.20 203.25
L770849D	L770810	1.5 0.06	478.0 18.82	3.3 0.13	567.0 22.32	3853.2	483.2	0.2247	95.00 209.46
EE737179D	737260	3.3 0.13	489.0 19.25	6.4 0.25	614.9 24.21	4809.1	573.4	0.2247	173.98 383.56
EE423181D	423300	6.4 0.25	507.0 19.96	6.4 0.25	708.0 27.87	6167.6	368.4	0.2325	413.25 911.07
EE525183D	525320	9.7 0.38	522.0 20.55	6.4 0.25	741.0 29.17	7501.7	378.4	0.2535	741.07 1633.68
EE480181D	480340	6.4 0.25	516.0 20.31	6.4 0.25	780.0 30.71	7384.2	343.1	0.2575	978.97 2158.21

⁽⁴⁾These maximum fillet radii will be cleared by bearing corners.
NOTE: For spacer configuration information, contact your Timken engineer.

TAPERED ROLLER BEARINGS

DOUBLE-ROW • TYPE TDI

TYPE TDI



Bearing Dimensions				Load Ratings							
Bore d	O.D. D	Width T	Double Inner Ring Width B	Dynamic ⁽¹⁾				Dynamic ⁽³⁾			
				C ₁₍₂₎	e	Y ₁	Y ₂	C ₉₀	C _{a90}	C ₉₀₍₂₎	K
mm in.	mm in.	mm in.	mm in.	N lbf				N lbf	N lbf	N lbf	
464.000 18.2677	615.000 24.2126	150.000 5.9055	136.000 5.3543	2710000 610000	0.8	0.9	1.3	404000 90800	551000 124000	703000 158000	0.73
479.425 18.8750	679.450 26.7500	238.125 9.3750	238.125 9.3750	6500000 1460000	0.3	2.0	3.0	968000 218000	551000 124000	1680000 379000	1.76
482.600 19.0000	615.950 24.2500	158.750 6.2500	158.750 6.2500	2950000 662000	0.3	2.0	3.0	439000 98600	250000 56100	764000 172000	1.76
488.950 19.2500	660.400 26.0000	171.450 6.7500	174.625 6.8750	4130000 928000	0.3	2.2	3.3	614000 138000	323000 72600	1070000 240000	1.90
489.026 19.2530	634.873 24.9950	152.400 6.0000	152.400 6.0000	2560000 574000	0.3	2.0	2.9	380000 85500	223000 50200	662000 149000	1.70
500.000 19.6850	660.000 25.9843	160.000 6.2992	160.000 6.2992	3090000 694000	0.7	0.9	1.4	460000 103000	583000 131000	800000 180000	0.79
501.650 19.7500	711.200 28.0000	250.825 9.8750	250.825 9.8750	6150000 1380000	0.3	2.0	3.0	916000 206000	521000 117000	1590000 358000	1.76
505.181 19.8890	838.200 33.0000	266.700 10.5000	266.700 10.5000	6290000 1410000	0.5	1.4	2.1	936000 210000	769000 173000	1630000 366000	1.22
508.000 20.0000	762.000 30.0000	219.075 8.6250	219.075 8.6250	5360000 1210000	0.4	1.8	2.7	799000 180000	519000 117000	1390000 313000	1.54
514.350 20.2500	673.100 26.5000	203.200 8.0000	203.200 8.0000	4130000 928000	0.3	2.1	3.2	615000 138000	336000 75400	1070000 241000	1.83
519.112 20.4375	736.600 29.0000	258.762 10.1875	258.762 10.1875	6570000 1480000	0.3	2.0	3.0	978000 220000	557000 125000	1700000 383000	1.76
519.112 20.4375	736.600 29.0000	258.762 10.1875	258.762 10.1875	6570000 1480000	0.3	2.0	3.0	978000 220000	557000 125000	1700000 383000	1.76
536.575 21.1250	761.873 29.9950	269.875 10.6250	269.875 10.6250	6980000 1570000	0.3	2.0	3.0	1040000 234000	592000 133000	1810000 407000	1.76
536.575 21.1250	761.873 29.9950	269.875 10.6250	269.875 10.6250	6980000 1570000	0.3	2.0	3.0	1040000 234000	592000 133000	1810000 407000	1.76
539.750 21.2500	784.225 30.8750	165.100 6.5000	161.925 6.3750	3770000 848000	0.5	1.4	2.1	561000 126000	457000 103000	977000 220000	1.23
558.673 21.9950	901.573 35.4950	457.200 18.0000	442.912 17.4375	15700000 3540000	0.4	1.9	2.8	2340000 526000	1460000 329000	4080000 917000	1.60
558.800 22.0000	660.400 26.0000	95.250 3.7500	92.075 3.6250	1360000 305000	0.6	1.2	1.8	202000 45400	189000 42400	352000 79000	1.07

⁽¹⁾Based on 1 x 10⁶ revolutions L₁₀ life, for the ISO life-calculation method. C₁₍₂₎ is the double-row radial value.

⁽²⁾Consult your Timken engineer for instructions on use or review the Timken Engineering Manual on timken.com/catalogs.

⁽³⁾Based on 90 x 10⁶ revolutions L₁₀ life, for The Timken Company life-calculation method. C₉₀ and C_{a90} are radial and thrust values for a single row. C₉₀₍₂₎ is the double-row radial value.

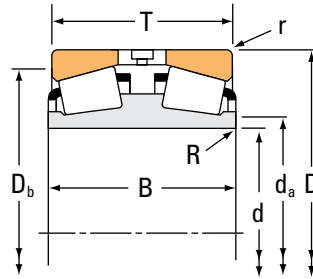
Part Number		Dimensions				Geometry Factors			Bearing Weight
Inner	Outer	Shaft		Housing		G ₁	G ₂	C _g	
		Max Shaft Fillet Radius R ⁽⁴⁾	Backing Shoulder Dia. d _a	Max Housing Fillet Radius r ⁽⁴⁾	Backing Shoulder Dia. D _b				kg lbs.
		mm in.	mm in.	mm in.	mm in.				
NP609202	NP357825	2.0 0.08	490.0 19.29	4.0 0.16	573.0 22.56	4033.4	478.0	0.2668	116.36 256.54
M272749D	M272710	3.3 0.13	510.0 20.08	6.4 0.25	633.0 24.92	8110.8	508.6	0.2598	286.50 631.63
LM272249D	LM272210	3.3 0.13	504.0 19.84	6.4 0.25	585.0 23.03	6037.2	665.8	0.2333	115.10 253.77
EE640193D	640260	3.3 0.13	516.0 20.31	6.4 0.25	624.0 24.57	6322.4	601.7	0.2310	168.17 370.70
EE243193D	243250	3.3 0.13	516.0 20.31	3.3 0.13	603.0 23.74	6057.3	726.6	0.2350	126.03 277.85
NP025753	NP652808	3.5 0.14	525.0 20.67	5.0 0.20	615.0 24.21	4951.9	567.5	0.2797	144.99 319.67
M274149D	M274110	3.3 0.13	534.0 21.02	6.4 0.25	663.0 26.10	9019.6	560.7	0.2690	339.24 747.88
EE426198D	426330	6.4 0.25	555.0 21.85	9.7 0.38	759.0 29.88	6651.9	435.2	0.2722	600.54 1323.96
EE531201D	531300	6.4 0.25	550.7 21.68	6.4 0.25	710.9 27.99	6784.6	473.8	0.2541	345.54 761.84
LM274449D	LM274410	3.3 0.13	540.0 21.26	6.4 0.25	636.0 25.04	8252.3	802.0	0.2561	321.70 709.11
M275349D	M275310	3.3 0.13	552.0 21.73	6.4 0.25	684.0 26.93	9814.6	651.6	0.2766	383.08 844.57
M275348D	M275310	3.3 0.13	552.0 21.73	6.4 0.25	684.0 26.93	9814.6	651.6	0.2766	381.64 841.40
M276449D	M276410	3.3 0.13	564.0 22.20	6.4 0.25	711.0 27.99	10625.0	614.5	0.2839	415.94 917.01
M276448D	M276410	3.3 0.13	564.0 22.20	6.4 0.25	711.0 27.99	10625.0	614.5	0.2839	415.91 916.95
EE522126D	523087	3.3 0.13	573.0 22.56	6.4 0.25	732.0 28.82	5013.3	457.2	0.2452	240.64 530.53
EE546220D	546355	6.4 0.25	621.0 24.45	12.7 0.50	816.0 32.13	14325.6	376.4	0.3250	1170.74 2581.03
LL876449D	LL876410	1.5 0.06	576.0 22.68	3.3 0.13	636.0 25.04	4668.3	1119.2	0.2467	54.75 120.67

⁽⁴⁾These maximum fillet radii will be cleared by bearing corners.
NOTE: For spacer configuration information, contact your Timken engineer.

TAPERED ROLLER BEARINGS

DOUBLE-ROW • TYPE TDI

TYPE TDI



Bearing Dimensions				Load Ratings							
Bore d	O.D. D	Width T	Double Inner Ring Width B	Dynamic ⁽¹⁾				Dynamic ⁽³⁾			
				C ₁₍₂₎	e	Y ₁	Y ₂	C ₉₀	C _{a90}	C ₉₀₍₂₎	K
mm in.	mm in.	mm in.	mm in.	N lbf				N lbf	N lbf	N lbf	
558.800 22.0000	736.600 29.0000	155.575 6.1250	155.575 6.1250	3600000 810000	0.3	2.0	2.9	536000 121000	315000 70700	934000 210000	1.70
558.800 22.0000	736.600 29.0000	196.850 7.7500	196.850 7.7500	4480000 1010000	0.4	2.0	2.9	667000 150000	395000 88800	1160000 261000	1.69
571.500 22.5000	812.800 32.0000	285.750 11.2500	285.750 11.2500	7890000 1770000	0.3	2.0	3.0	1180000 264000	669000 150000	2050000 460000	1.76
585.788 23.0625	771.525 30.3750	230.188 9.0625	230.188 9.0625	5730000 1290000	0.3	2.0	3.0	853000 192000	486000 109000	1490000 334000	1.76
585.788 23.0625	771.525 30.3750	230.188 9.0625	230.188 9.0625	5730000 1290000	0.3	2.0	3.0	853000 192000	486000 109000	1490000 334000	1.76
600.000 23.6220	1170.000 46.0630	510.000 20.0787	510.000 20.0787	20500000 4610000	0.5	1.4	2.0	3050000 687000	2590000 581000	5320000 1200000	1.18
609.600 24.0000	787.400 31.0000	171.450 6.7500	171.450 6.7500	4550000 1020000	0.4	1.8	2.7	677000 152000	430000 96600	1180000 265000	1.58
609.600 24.0000	863.600 34.0000	317.500 12.5000	317.500 12.5000	10500000 2370000	0.3	2.0	3.0	1570000 353000	893000 201000	2730000 614000	1.76
630.000 24.8031	1030.000 40.5512	315.000 12.4016	315.000 12.4016	12200000 2750000	0.5	1.5	2.2	1820000 409000	1410000 316000	3170000 713000	1.30
635.000 25.0000	901.700 35.5000	317.500 12.5000	317.500 12.5000	9560000 2150000	0.3	2.0	3.0	1420000 320000	810000 182000	2480000 557000	1.76
635.000 25.0000	939.800 37.0000	304.800 12.0000	304.800 12.0000	7950000 1790000	0.6	1.2	1.8	1180000 266000	1170000 262000	2060000 463000	1.01
647.700 25.5000	1028.700 40.5000	279.400 11.0000	273.050 10.7500	9760000 2190000	0.3	2.2	3.2	1450000 327000	782000 176000	2530000 569000	1.86
660.400 26.0000	812.800 32.0000	176.212 6.9375	176.212 6.9375	4760000 1070000	0.3	2.0	3.0	709000 159000	404000 90700	1230000 278000	1.76
660.400 26.0000	1066.800 42.0000	321.470 12.6563	311.942 12.2812	11400000 2560000	0.3	2.2	3.2	1690000 381000	898000 202000	2950000 663000	1.89
660.400 26.0000	1104.900 43.5000	571.500 22.5000	571.500 22.5000	14500000 3260000	0.3	2.0	2.9	2160000 486000	1280000 287000	3760000 846000	1.69
682.625 26.8750	965.200 38.0000	338.138 13.3125	338.138 13.3125	10900000 2440000	0.3	2.0	3.0	1620000 364000	921000 207000	2820000 634000	1.76
708.025 27.8750	930.275 36.6250	273.050 10.7500	273.050 10.7500	8060000 1810000	0.3	2.0	3.0	1200000 270000	684000 154000	2090000 470000	1.76

⁽¹⁾Based on 1 x 10⁶ revolutions L₁₀ life, for the ISO life-calculation method. C₁₍₂₎ is the double-row radial value.

⁽²⁾Consult your Timken engineer for instructions on use or review the Timken Engineering Manual on timken.com/catalogs.

⁽³⁾Based on 90 x 10⁶ revolutions L₁₀ life, for The Timken Company life-calculation method. C₉₀ and C_{a90} are radial and thrust values for a single row. C₉₀₍₂₎ is the double-row radial value.

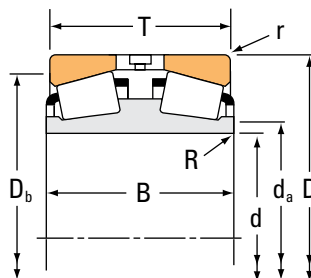
Part Number		Dimensions				Geometry Factors			Bearing Weight
Inner	Outer	Shaft		Housing		G ₁	G ₂	C _g	
		Max Shaft Fillet Radius R ⁽⁴⁾	Backing Shoulder Dia. d _a	Max Housing Fillet Radius r ⁽⁴⁾	Backing Shoulder Dia. D _b				
		mm in.	mm in.	mm in.	mm in.				kg lbs.
EE843221D	843290	3.3 0.13	585.0 23.03	6.4 0.25	699.0 27.52	7097.5	714.8	0.2478	177.96 392.34
LM377449D	LM377410	3.3 0.13	588.0 23.15	6.4 0.25	696.0 27.40	9314.8	907.6	0.2735	237.01 522.50
M278749D	M278710	3.3 0.13	609.0 23.98	6.4 0.25	756.0 29.76	12425.1	669.4	0.2990	489.64 1079.48
LM278849D	LM278810	3.3 0.13	615.0 24.21	6.4 0.25	726.0 28.58	11553.5	930.7	0.2906	302.98 667.96
LM278848D	LM278810	6.4 0.25	616.0 24.25	6.4 0.25	726.0 28.58	11553.5	930.7	0.2906	302.76 667.48
NP726553	NP137813	10.0 0.39	708.0 27.87	10.0 0.39	1040.0 40.94	15142.1	383.3	0.3624	2575.44 5674.87
EE649241D	649310	3.3 0.13	636.0 25.04	6.4 0.25	747.0 29.41	9384.8	930.0	0.2790	217.30 479.00
M280349D	M280310	3.3 0.13	648.0 25.51	6.4 0.25	807.0 31.77	14433.6	688.8	0.3143	608.49 1341.48
NP689200	NP360973	7.5 0.30	690.0 27.17	8.0 0.32	945.0 37.20	11932.9	565.6	0.3241	1060.79 2338.55
M281049D	M281010	3.3 0.13	675.0 26.57	6.4 0.25	843.0 33.19	15906.3	881.4	0.3244	686.09 1512.56
LM881245D	LM881214	3.3 0.13	684.0 26.93	6.4 0.25	873.0 34.37	10936.2	636.2	0.3398	738.59 1628.30
EE424257D	424405	11.0 0.43	713.5 28.09	6.4 0.25	960.0 37.80	12039.2	632.2	0.2880	863.66 1904.05
L281149D	L281110	3.3 0.13	682.8 26.88	6.4 0.25	777.0 30.59	12635.6	984.9	0.2968	206.17 454.56
EE428262D	428420	6.4 0.25	717.0 28.23	6.4 0.25	990.0 38.98	13917.6	590.9	0.3012	1101.53 2428.47
EE627260D	627435	12.7 0.50	740.0 29.13	3.3 0.13	1010.0 39.76	18464.3	651.3	0.3447	2038.55 4494.20
M282249D	M282210	3.3 0.13	723.0 28.46	6.4 0.25	900.0 35.43	18773.0	843.1	0.3426	843.10 1858.77
LM282549D	LM282510	3.3 0.13	741.0 29.17	6.4 0.25	879.0 34.61	18246.3	1087.0	0.3379	519.26 1144.78

⁽⁴⁾These maximum fillet radii will be cleared by bearing corners.
NOTE: For spacer configuration information, contact your Timken engineer.

TAPERED ROLLER BEARINGS

DOUBLE-ROW TYPE TDI

TYPE TDI



Bearing Dimensions				Load Ratings							
Bore d	O.D. D	Width T	Double Inner Ring Width B	Dynamic ⁽¹⁾				Dynamic ⁽³⁾			
				C ₁₍₂₎	e	Y ₁	Y ₂	C ₉₀	C _{a90}	C ₉₀₍₂₎	K
mm in.	mm in.	mm in.	mm in.	N lbf				N lbf	N lbf	N lbf	
711.200 28.0000	914.400 36.0000	149.225 5.8750	149.225 5.8750	4150000 934000	0.4	1.8	2.6	619000 139000	403000 90600	1080000 242000	1.54
730.250 28.7500	1035.050 40.7500	365.125 14.3750	365.125 14.3750	12400000 2790000	0.3	2.0	3.0	1850000 416000	1050000 237000	3220000 724000	1.76
749.300 29.5000	1066.800 42.0000	361.950 14.2500	349.250 13.7500	12400000 2790000	0.3	2.1	3.1	1850000 415000	1040000 234000	3220000 723000	1.77
749.300 29.5000	1181.100 46.5000	355.600 14.0000	355.600 14.0000	13000000 2920000	0.4	1.8	2.7	1930000 434000	1240000 278000	3360000 756000	1.56
762.000 30.0000	1079.500 42.5000	381.000 15.0000	381.000 15.0000	13400000 3010000	0.3	2.0	3.0	1990000 448000	1130000 255000	3470000 780000	1.76
779.925 30.7057	1219.873 48.0265	406.674 16.0108	406.674 16.0108	15500000 3480000	0.4	1.7	2.6	2310000 519000	1550000 347000	4020000 903000	1.49
787.400 31.0000	1219.200 48.0000	406.400 16.0000	406.400 16.0000	15500000 3480000	0.4	1.7	2.6	2310000 519000	1550000 347000	4020000 903000	1.49
825.500 32.5000	1168.400 46.0000	409.575 16.1250	409.575 16.1250	15600000 3500000	0.3	2.0	3.0	2320000 521000	1320000 297000	4040000 908000	1.76
840.000 33.0709	1040.000 40.9449	180.000 7.0866	170.000 6.6929	4260000 958000	0.4	1.5	2.3	634000 143000	475000 107000	1100000 248000	1.33
863.600 34.0000	1130.300 44.5000	323.850 12.7500	323.850 12.7500	11400000 2550000	0.3	2.0	3.0	1690000 380000	963000 216000	2940000 662000	1.76
863.600 34.0000	1219.200 48.0000	438.150 17.2500	425.450 16.7500	16900000 3790000	0.3	2.0	3.0	2510000 565000	1430000 322000	4380000 984000	1.76
901.700 35.5000	1295.400 51.0000	450.850 17.7500	438.150 17.2500	19500000 4380000	0.3	2.0	3.0	2900000 653000	1670000 376000	5050000 1140000	1.74
938.212 36.9375	1270.000 50.0000	400.050 15.7500	400.050 15.7500	15900000 3570000	0.3	2.0	3.0	2360000 532000	1350000 303000	4120000 926000	1.76
939.800 37.0000	1333.500 52.5000	463.550 18.2500	463.550 18.2500	19900000 4480000	0.3	2.0	3.0	2970000 667000	1690000 379000	5160000 1160000	1.76
939.800 37.0000	1333.500 52.5000	463.550 18.2500	463.550 18.2500	19900000 4480000	0.3	2.0	3.0	2970000 667000	1690000 379000	5160000 1160000	1.76
1200.150 47.2500	1593.850 62.7500	482.600 19.0000	482.600 19.0000	23600000 5300000	0.3	2.0	3.0	3510000 789000	2000000 449000	6110000 1370000	1.76

⁽¹⁾Based on 1 x 10⁶ revolutions L₁₀ life, for the ISO life-calculation method. C₁₍₂₎ is the double-row radial value.

⁽²⁾Consult your Timken engineer for instructions on use or review the Timken Engineering Manual on timken.com/catalogs.

⁽³⁾Based on 90 x 10⁶ revolutions L₁₀ life, for The Timken Company life-calculation method. C₉₀ and C_{a90} are radial and thrust values for a single row. C₉₀₍₂₎ is the double-row radial value.

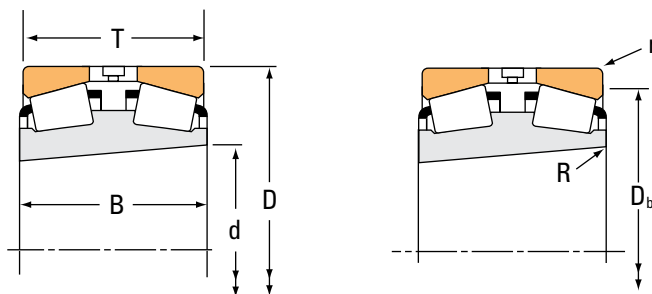
Part Number		Dimensions				Geometry Factors			Bearing Weight
Inner	Outer	Shaft		Housing		G ₁	G ₂	C _g	
		Max Shaft Fillet Radius R ⁽⁴⁾	Backing Shoulder Dia. d _a	Max Housing Fillet Radius r ⁽⁴⁾	Backing Shoulder Dia. D _b				kg lbs.
		mm in.	mm in.	mm in.	mm in.				
EE755281D	755360	3.3 0.13	744.0 29.29	6.4 0.25	873.0 34.37	11122.5	1282.2	0.2952	247.94 546.60
M283449D	M283410	3.3 0.13	774.0 30.47	6.4 0.25	966.0 38.03	22247.2	891.2	0.3623	1031.10 2273.18
EE325296D	325420	9.5 0.37	806.5 31.75	12.7 0.50	996.0 39.21	21246.2	980.3	0.3551	1054.26 2324.28
EE690296D	690465	6.4 0.25	813.0 32.01	12.7 0.50	1085.0 42.72	19196.6	776.6	0.3569	1449.65 3195.93
M284249D	M284210	4.8 0.19	810.0 31.89	12.7 0.50	1005.0 39.57	24517.9	978.3	0.3741	1176.35 2593.38
EE631307D	631484	6.4 0.25	849.0 33.43	12.7 0.50	1125.0 44.29	24096.1	871.4	0.3916	1875.04 4133.58
EE631311D	631480	6.4 0.25	852.0 33.54	12.7 0.50	1125.0 44.29	24096.1	871.4	0.3916	1758.20 3876.07
M285848D	M285810	4.8 0.19	879.0 34.61	12.7 0.50	1085.0 42.72	29774.1	1207.4	0.3989	1478.41 3259.34
NP385417	NP439444	6.0 0.24	876.0 34.49	6.4 0.25	996.0 39.21	14184.2	1690.0	0.3333	315.36 695.25
LM286249D	LM286210	4.8 0.19	906.0 35.67	12.7 0.50	1065.0 41.93	28956.1	1086.1	0.3933	897.71 1979.10
EE547341D	547480	4.8 0.19	918.0 36.14	12.7 0.50	1135.0 44.69	33010.2	940.9	0.4127	1653.01 3644.25
EE634356D	634510	4.8 0.19	960.0 37.80	12.7 0.50	1205.0 47.44	35828.3	1141.4	0.4256	2034.61 4485.59
LM287649D	LM287610	4.8 0.19	990.0 38.98	12.7 0.50	1190.0 46.85	37220.5	1611.3	0.4283	1544.70 3405.44
LM287849D	LM287810	4.8 0.19	999.0 39.33	12.7 0.50	1240.0 48.82	40833.7	1438.6	0.4427	2190.95 4830.24
LM287849AD	LM287810	4.8 0.19	999.0 39.33	12.7 0.50	1240.0 48.82	40833.7	1438.6	0.4427	2183.29 4813.36
LM288949D	LM288910	4.8 0.19	1260.0 49.61	12.7 0.50	1500.0 59.06	66115.7	2354.8	0.5174	2744.57 6050.73

⁽⁴⁾These maximum fillet radii will be cleared by bearing corners.
NOTE: For spacer configuration information, contact your Timken engineer.

TAPERED ROLLER BEARINGS

DOUBLE-ROW • TYPE TDIT

TYPE TDIT



Bearing Dimensions					Load Ratings							
Bore d	Taper	O.D. D	Width T	Double Inner Ring Width B	Dynamic ⁽¹⁾				Dynamic ⁽³⁾			
					C ₁₍₂₎	e	Y ₁	Y ₂	C ₉₀	C _{a90}	C ₉₀₍₂₎	K
mm in.		mm in.	mm in.	mm in.	N lbf				N lbf	N lbf	N lbf	
37.037 1.4581	1:19.2	72.000 2.8346	39.096 1.5392	38.100 1.5000	83400 18700	0.44	1.52	2.26	12400 2790	9440 2120	21600 4860	1.31
100.211 3.9453	1:19.2	168.275 6.6250	95.250 3.7500	95.250 3.7500	435000 97800	0.47	1.43	2.14	64800 14600	52200 11700	113000 25400	1.24
101.600 4.0000	1:12	190.500 7.5000	117.475 4.6250	127.000 5.0000	878000 197000	0.33	2.02	3.00	131000 29400	74900 16800	228000 51100	1.74
115.888 4.5625	1:19.2	190.500 7.5000	107.950 4.2500	111.125 4.3750	598000 134000	0.42	1.62	2.42	89000 20000	63400 14300	155000 34800	1.40
206.375 8.1250	1:12	336.550 13.2500	180.975 7.1250	184.150 7.2500	2230000 501000	0.33	2.03	3.02	332000 74600	189000 42500	578000 130000	1.76
209.550 8.2500	1:12	317.500 12.5000	184.150 7.2500	184.150 7.2500	1200000 270000	0.52	1.29	1.92	179000 40200	160000 36100	312000 70100	1.12
214.973 8.4635	1:12	285.750 11.2500	92.075 3.6250	92.075 3.6250	707000 159000	0.48	1.40	2.09	105000 23700	86700 19500	183000 41200	1.21
219.075 8.6250	1:12	358.775 14.1250	196.850 7.7500	200.025 7.8750	2520000 566000	0.33	2.03	3.02	375000 84200	213000 47900	652000 147000	1.76
219.936 8.6589	1:12	314.325 12.3750	115.888 4.5625	123.822 4.8749	1210000 272000	0.33	2.03	3.02	180000 40500	103000 23100	314000 70500	1.76
234.950 9.2500	1:12	355.600 14.0000	165.100 6.5000	165.100 6.5000	1390000 312000	0.33	2.04	3.04	206000 46400	117000 26200	359000 80800	1.77
234.950 9.2500	1:12	355.600 14.0000	184.150 7.2500	184.150 7.2500	1390000 312000	0.33	2.04	3.04	206000 46400	117000 26200	359000 80800	1.77
243.152 9.5729	1:12	327.025 12.8750	92.075 3.6250	101.600 4.0000	987000 222000	0.32	2.10	3.13	147000 33000	80800 18200	256000 57500	1.82
252.412 9.9375	1:12	358.775 14.1250	130.175 5.1250	139.700 5.5000	1590000 358000	0.33	2.03	3.02	237000 53300	135000 30300	413000 92800	1.76
263.525 10.3750	1:12	400.050 15.7500	196.847 7.7499	192.088 7.5625	1440000 324000	0.39	1.71	2.55	215000 48200	145000 32600	374000 84000	1.48
266.700 10.5000	1:12	355.600 14.0000	107.950 4.2500	109.538 4.3125	1400000 315000	0.36	1.87	2.79	209000 46900	129000 28900	363000 81600	1.62
269.875 10.6250	1:12	381.000 15.0000	136.525 5.3750	136.525 5.3750	2000000 450000	0.33	2.03	3.02	298000 67000	170000 38100	519000 117000	1.76
280.000 11.0236	1:12	409.981 16.1410	206.375 8.1250	206.375 8.1250	1510000 340000	0.39	1.75	2.60	225000 50600	149000 33400	392000 88100	1.51

⁽¹⁾Based on 1 x 10⁶ revolutions L₁₀ life, for the ISO life-calculation method. C₁₍₂₎ is the double-row radial value.

⁽²⁾Consult your Timken engineer for instructions on use or review the Timken Engineering Manual on timken.com/catalogs.

⁽³⁾Based on 90 x 10⁶ revolutions L₁₀ life, for The Timken Company life-calculation method. C₉₀ and C_{a90} are radial and thrust values for a single row. C₉₀₍₂₎ is the double-row radial value.

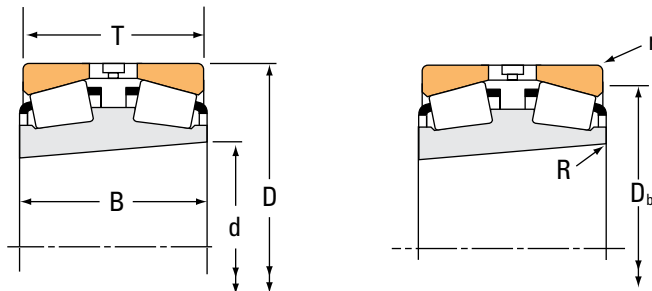
Part Number		Dimensions			Geometry Factors			Bearing Weight
Inner	Outer	Shaft	Housing		G ₁	G ₂	C _g	
		Max Shaft Fillet Radius R ⁽⁴⁾	Max Housing Fillet Radius r ⁽⁴⁾	Backing Shoulder Dia. D _b				kg
		mm in.	mm in.	mm in.				kg lbs.
19146TD	19283	0.8 0.03	1.5 0.06	63.0 2.48	17.5	11.5	0.0694	0.71 1.58
688TD	672	0.8 0.03	3.3 0.13	149.0 5.87	182.5	37.3	0.1056	8.38 18.46
HH221449TD	HH221410	0.8 0.03	3.3 0.13	171.0 6.73	265.6	28.4	0.1072	14.90 32.87
71457TD	71750	1.5 0.06	3.3 0.13	171.0 6.73	269.2	49.5	0.1156	12.08 26.63
H242649TD	H242610	1.5 0.06	3.3 0.13	306.0 12.05	1404.1	134.8	0.1465	49.31 108.74
93826TD	93125	1.5 0.06	3.3 0.13	286.0 11.26	912.5	126.1	0.1460	45.37 100.05
LM742746TD	LM742710	1.5 0.06	3.3 0.13	266.0 10.47	866.9	225.2	0.1388	16.00 35.25
H244848TD	H244810	1.5 0.06	6.4 0.25	323.0 12.72	1631.9	150.0	0.1540	83.34 183.74
M244246TD	M244210	1.5 0.06	3.3 0.13	293.0 11.54	1149.7	141.4	0.1360	31.68 69.85
EE130926TD	131400	1.5 0.06	1.5 0.06	329.0 12.95	1162.0	167.6	0.1358	51.55 113.66
EE130927TD	131400	1.5 0.06	1.5 0.06	329.0 12.95	1162.0	167.6	0.1358	54.20 119.51
LM247747TD	LM247710	1.5 0.06	3.3 0.13	310.0 12.20	1173.3	243.9	0.1345	23.70 52.24
M249746TD	M249710	1.5 0.06	3.3 0.13	335.0 13.19	1626.0	173.0	0.1526	45.97 101.36
EE221039TD	221575	1.5 0.06	6.4 0.25	366.0 14.41	1320.8	207.5	0.1497	70.69 155.85
LM451349TD	LM451310	1.5 0.06	3.3 0.13	335.0 13.19	1554.1	212.2	0.1536	30.99 68.32
M252349TD	M252310	1.5 0.06	3.3 0.13	356.0 14.02	1839.2	226.1	0.1588	50.82 112.03
EE128113TD	128161	3.3 0.13	3.3 0.13	379.0 14.92	1622.7	240.4	0.1592	78.15 172.27

⁽⁴⁾These maximum fillet radii will be cleared by bearing corners.
NOTE: For spacer configuration information, contact your Timken engineer.

TAPERED ROLLER BEARINGS

DOUBLE-ROW • TYPE TDIT

TYPE TDIT



Bearing Dimensions					Load Ratings							
Bore d	Taper	O.D. D	Width T	Double Inner Ring Width B	Dynamic ⁽¹⁾				Dynamic ⁽³⁾			
					C ₁₍₂₎	e	Y ₁	Y ₂	C ₉₀	C _{a90}	C ₉₀₍₂₎	K
mm in.		mm in.	mm in.	mm in.	N lbf				N lbf	N lbf	N lbf	
288.925 11.3750	1:12	406.400 16.0000	144.462 5.6875	144.462 5.6875	2070000 466000	0.34	2.00	2.97	308000 69300	179000 40100	537000 121000	1.73
295.275 11.6250	1:12	406.400 16.0000	203.200 8.0000	203.200 8.0000	1340000 301000	0.44	1.53	2.28	199000 44800	151000 33900	347000 78100	1.32
297.523 11.7135	1:12	422.275 16.6250	150.812 5.9375	160.338 6.3125	2260000 508000	0.34	2.00	2.99	336000 75600	194000 43600	586000 132000	1.73
303.212 11.9375	1:12	495.300 19.5000	263.525 10.3750	263.525 10.3750	5000000 1120000	0.33	2.03	3.02	744000 167000	423000 95200	1300000 291000	1.76
304.655 11.9943	1:12	438.048 17.2460	131.762 5.1875	131.762 5.1875	1880000 422000	0.33	2.04	3.03	280000 62900	159000 35700	487000 110000	1.76
316.111 12.4453	1:12	447.675 17.6250	157.429 6.1980	173.035 6.8124	2920000 656000	0.33	2.02	3.00	435000 97800	249000 56000	757000 170000	1.74
333.375 13.1250	1:12	523.875 20.6250	185.738 7.3125	185.738 7.3125	3960000 890000	0.33	2.03	3.02	589000 132000	335000 75400	1030000 231000	1.76
333.375 13.1250	1:12	469.900 18.5000	166.688 6.5625	166.688 6.5625	2780000 626000	0.33	2.02	3.00	415000 93200	238000 53400	722000 162000	1.74
346.075 13.6250	1:12	488.950 19.2500	174.625 6.8750	174.625 6.8750	3010000 676000	0.33	2.02	3.00	448000 101000	257000 57700	780000 175000	1.74
347.662 13.6875	1:12	469.900 18.5000	228.600 9.0000	228.600 9.0000	2490000 561000	0.33	2.03	3.02	372000 83500	212000 47500	647000 145000	1.76
349.250 13.7500	1:12	457.200 18.0000	120.650 4.7500	120.650 4.7500	1640000 368000	0.32	2.12	3.15	244000 54900	133000 29900	425000 95500	1.83
368.300 14.5000	1:12	523.875 20.6250	185.738 7.3125	185.738 7.3125	3960000 890000	0.33	2.03	3.02	589000 132000	335000 75400	1030000 231000	1.76
384.175 15.1250	1:12	546.100 21.5000	193.675 7.6250	193.675 7.6250	4290000 963000	0.33	2.03	3.02	638000 143000	363000 81700	1110000 250000	1.76
406.400 16.0000	1:12	590.550 23.2500	209.550 8.2500	209.550 8.2500	4970000 1120000	0.33	2.03	3.02	740000 166000	421000 94800	1290000 290000	1.76
415.925 16.3750	1:12	590.550 23.2500	209.550 8.2500	209.550 8.2500	4970000 1120000	0.33	2.03	3.02	740000 166000	421000 94800	1290000 290000	1.76
431.800 17.0000	1:12	571.500 22.5000	161.925 6.3750	161.925 6.3750	3320000 747000	0.44	1.54	2.29	495000 111000	371000 83500	862000 194000	1.33
447.675 17.6250	1:12	635.000 25.0000	223.838 8.8125	223.838 8.8125	5700000 1280000	0.33	2.03	3.02	849000 191000	484000 109000	1480000 332000	1.76

⁽¹⁾Based on 1 x 10⁶ revolutions L₁₀ life, for the ISO life-calculation method. C₁₍₂₎ is the double-row radial value.

⁽²⁾Consult your Timken engineer for instructions on use or review the Timken Engineering Manual on timken.com/catalogs.

⁽³⁾Based on 90 x 10⁶ revolutions L₁₀ life, for The Timken Company life-calculation method. C₉₀ and C_{a90} are radial and thrust values for a single row. C₉₀₍₂₎ is the double-row radial value.

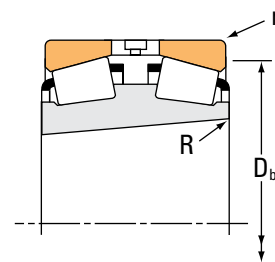
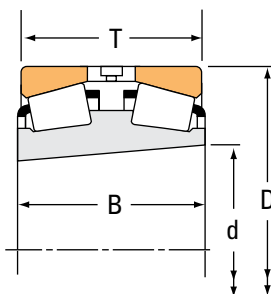
Part Number		Dimensions			Geometry Factors			Bearing Weight
Inner	Outer	Shaft	Housing		G ₁	G ₂	C _g	
		Max Shaft Fillet Radius R ⁽⁴⁾	Max Housing Fillet Radius r ⁽⁴⁾	Backing Shoulder Dia. D _b				kg lbs.
		mm in.	mm in.	mm in.				
M255449TD	M255410	3.3 0.13	3.3 0.13	379.0 14.92	2301.3	287.6	0.1722	62.40 137.58
LM757043TD	LM757010	1.5 0.06	3.3 0.13	380.0 14.96	1988.6	260.3	0.1775	72.69 160.24
HM256846TD	HM256810	3.3 0.13	3.3 0.13	394.0 15.51	2548.4	281.8	0.1779	76.21 168.01
HH258249TD	HH258210	3.3 0.13	6.4 0.25	448.0 17.64	3853.2	220.0	0.2048	224.54 495.02
NP868174	329172	7.6 0.30	3.3 0.13	410.0 16.14	2051.2	257.0	0.1638	65.38 144.13
HM259045TD	HM259010	3.0 0.12	3.3 0.13	418.0 16.46	2944.6	303.9	0.1863	89.79 197.96
HM265032TD	HM265010	3.3 0.13	6.4 0.25	487.0 19.17	4297.3	412.9	0.2106	166.14 366.28
HM261049TD	HM261010	3.3 0.13	3.3 0.13	439.0 17.28	3306.8	324.3	0.1935	97.71 215.41
HM262749TD	HM262710	3.3 0.13	3.3 0.13	456.0 17.95	3646.2	341.8	0.1999	115.19 253.98
M262448TD	M262410	3.3 0.13	3.3 0.13	443.0 17.44	2968.5	408.3	0.1853	100.23 220.99
LM263145TD	LM263110	1.5 0.06	3.3 0.13	434.0 17.09	3094.1	470.9	0.1845	55.07 121.39
HM265049TD	HM265010	3.3 0.13	6.4 0.25	487.0 19.17	4297.3	412.9	0.2106	141.40 311.73
HM266449TD	HM266410	3.3 0.13	6.4 0.25	507.0 19.96	4760.1	301.5	0.2178	157.92 348.16
M268743TD	M268710	3.3 0.13	6.4 0.25	548.9 21.61	5754.9	420.9	0.2319	214.22 472.24
M268749TD	M268710	3.3 0.13	6.4 0.25	548.9 21.61	5754.9	420.9	0.2319	198.81 438.27
LM769349TD	LM769310	1.5 0.06	6.4 0.25	534.0 21.02	5114.6	614.2	0.2426	119.48 263.42
M270749TD	M270710	3.3 0.13	6.4 0.25	591.0 23.27	6865.6	481.9	0.2458	245.12 540.38

⁽⁴⁾These maximum fillet radii will be cleared by bearing corners.
NOTE: For spacer configuration information, contact your Timken engineer.

TAPERED ROLLER BEARINGS

DOUBLE-ROW • TYPE TDIT

TYPE TDIT



Bearing Dimensions					Load Ratings							
Bore d	Taper	O.D. D	Width T	Double Inner Ring Width B	Dynamic ⁽¹⁾				Dynamic ⁽³⁾			
					C ₁₍₂₎	e	Y ₁	Y ₂	C ₉₀	C _{a90}	C ₉₀₍₂₎	K
mm in.		mm in.	mm in.	mm in.	N lbf				N lbf	N lbf	N lbf	
457.200 18.0000	1:12	730.148 28.7460	330.200 13.0000	330.200 13.0000	7050000 1580000	0.29	2.29	3.42	1050000 236000	529000 119000	1830000 411000	1.98
479.425 18.8750	1:12	679.450 26.7500	238.125 9.3750	238.125 9.3750	6500000 1460000	0.33	2.03	3.02	968000 218000	551000 124000	1680000 379000	1.76
501.650 19.7500	1:12	711.200 28.0000	250.825 9.8750	250.825 9.8750	6150000 1380000	0.33	2.03	3.02	916000 206000	521000 117000	1590000 358000	1.76
501.650 19.7500	1:12	711.200 28.0000	250.825 9.8750	250.825 9.8750	6150000 1380000	0.33	2.03	3.02	916000 206000	521000 117000	1590000 358000	1.76
519.112 20.4375	1:12	736.600 29.0000	258.762 10.1875	258.762 10.1875	6570000 1480000	0.33	2.03	3.02	978000 220000	557000 125000	1700000 383000	1.76
571.500 22.5000	1:12	812.800 32.0000	285.750 11.2500	296.862 11.6875	7890000 1770000	0.33	2.03	3.02	1180000 264000	669000 150000	2050000 460000	1.76

⁽¹⁾Based on 1×10^6 revolutions L_{10} life, for the ISO life-calculation method. $C_{1(2)}$ is the double-row radial value.

⁽²⁾Consult your Timken engineer for instructions on use or review the Timken Engineering Manual on timken.com/catalogs.

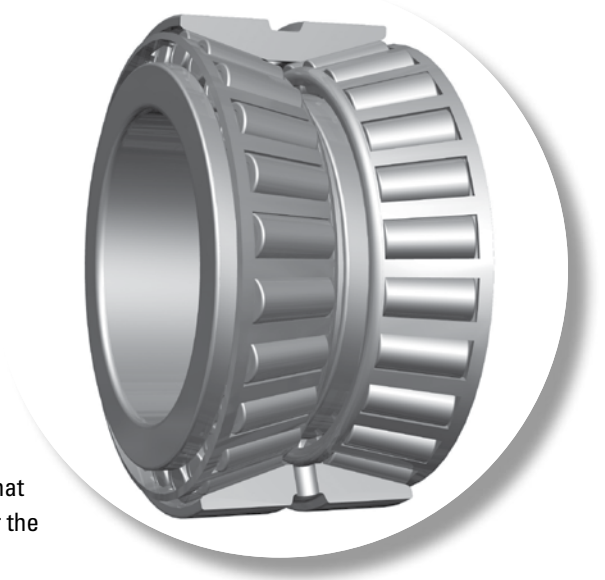
⁽³⁾Based on 90×10^6 revolutions L_{10} life, for The Timken Company life-calculation method. C_{90} and C_{a90} are radial and thrust values for a single row. $C_{90(2)}$ is the double-row radial value.

Part Number		Dimensions			Geometry Factors			Bearing Weight
Inner	Outer	Shaft	Housing		G ₁	G ₂	C _g	
		Max Shaft Fillet Radius R ⁽⁴⁾	Max Housing Fillet Radius r ⁽⁴⁾	Backing Shoulder Dia. D _b				kg lbs.
EE726182TD	726287	6.4 0.25	6.4 0.25	674.9 26.57	7359.2	384.7	0.2413	517.73 1141.38
M272749TD	M272710	3.3 0.13	6.4 0.25	633.0 24.92	8110.8	508.6	0.2598	303.33 668.74
M274149TD	M274110	3.3 0.13	6.4 0.25	663.0 26.10	9019.6	560.7	0.2690	346.76 764.45
M274147TD	M274110	9.7 0.38	6.4 0.25	663.0 26.10	9019.6	560.7	0.2690	355.25 783.17
M275349TD	M275310	3.3 0.13	6.4 0.25	684.0 26.93	9814.6	651.6	0.2766	391.96 864.14
M278748TD	M278710	3.3 0.13	6.4 0.25	756.0 29.76	12425.1	669.4	0.2990	520.85 1148.29

⁽⁴⁾These maximum fillet radii will be cleared by bearing corners.
 NOTE: For spacer configuration information, contact your Timken engineer.

TYPE TNA

- TNA bearings are non-adjustable, double-row bearings that are supplied with built-in clearance. This results in a specified mounting setting range satisfactory for specific applications.
- They are similar to type TDO, but the inner-ring front faces are extended so that they abut, which eliminates the need for the inner-ring spacer of a TDO bearing.
- They can be used at either fixed positions or allowed to float in the housing bore to compensate for shaft expansion.



DOUBLE-OUTER RING CONFIGURATIONS

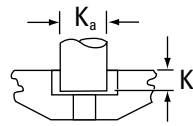
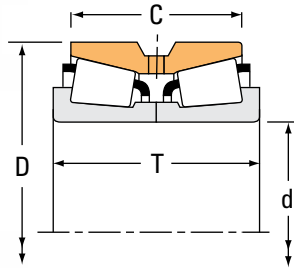
D	D suffix has a groove with oil holes for lubrication through the outer ring.
CD	CD suffix now replaces the DC suffix listed for part numbers in previous publications. Same features as D suffix, but CD also has groove with oil holes. One lubrication hole is counterbored to accept an anti-rotational pin. Default configuration for most series.

- For desired fitting practice and resultant mounted setting range information, contact your Timken engineer.
- If a closer control of mounted setting range is required, type TDO bearing assembly is recommended.
- Consult your Timken engineer before making a final bearing selection to help ensure suitability, availability and the most cost-effective solution.

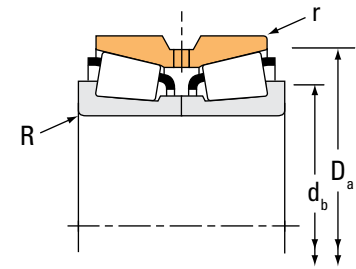
TAPERED ROLLER BEARINGS

DOUBLE-ROW • TYPE TNA

TYPE TNA



Locking pin for CD outer ring.



Bearing Dimensions				Load Ratings							
Bore d	O.D. D	Width T	Double Outer Ring Width C	Dynamic ⁽¹⁾		Factors ⁽²⁾		Dynamic ⁽³⁾			Factors ⁽²⁾
				C ₁₍₂₎	e	Y ₁	Y ₂	C ₉₀	C _{a90}	C ₉₀₍₂₎	K
mm in.	mm in.	mm in.	mm in.	N lbf				N lbf	N lbf	N lbf	
19.050 0.7500	47.000 1.8504	31.750 1.2500	25.212 0.9926	46500 10500	0.36	1.89	2.82	6930 1560	4230 952	12100 2710	1.64
24.981 0.9835	62.000 2.4409	39.688 1.5625	36.258 1.4275	75300 16900	0.38	1.77	2.63	11200 2520	7340 1650	19500 4390	1.53
28.575 1.1250	74.612 2.9375	55.565 2.1876	41.275 1.6250	121000 27300	0.60	1.12	1.67	18100 4060	18600 4190	31500 7080	0.97
29.987 1.1806	71.973 2.8336	42.760 1.6835	36.512 1.4375	102000 23000	0.36	1.87	2.79	18100 4060	11100 2500	31400 7070	1.62
31.750 1.2500	58.738 2.3125	32.542 1.2812	24.608 0.9688	55200 12400	0.47	1.42	2.12	8220 1850	6670 1500	14300 3220	1.23
33.337 1.3125	80.962 3.1875	55.562 2.1875	39.688 1.5625	135000 30400	0.67	1.01	1.50	20100 4520	23000 5170	35000 7880	0.87
34.925 1.3750	69.012 2.7170	46.040 1.8126	38.100 1.5000	95100 21400	0.38	1.77	2.63	14200 3180	9260 2080	24600 5540	1.53
34.976 1.3770	80.035 3.1510	46.040 1.8126	34.925 1.3750	111000 24800	0.40	1.68	2.50	19500 4390	13400 3020	34000 7640	1.45
36.512 1.4375	92.075 3.6250	55.562 2.1875	39.688 1.5625	147000 32900	0.78	0.86	1.29	25900 5810	34600 7770	45000 10100	0.75
38.100 1.5000	69.012 2.7170	46.035 1.8124	38.100 1.5000	98700 22200	0.40	1.68	2.50	17400 3920	12000 2700	30300 6820	1.45
39.687 1.5625	88.500 3.4843	55.562 2.1875	39.688 1.5625	147000 32900	0.78	0.86	1.29	21800 4910	29200 6560	38000 8540	0.75
39.687 1.5625	92.075 3.6250	55.562 2.1875	39.688 1.5625	147000 32900	0.78	0.86	1.29	21800 4910	29200 6560	38000 8540	0.75
40.000 1.5748	90.119 3.5480	50.800 2.0000	44.450 1.7500	142000 32000	0.31	2.20	3.28	21200 4770	11100 2500	36900 8310	1.91
41.275 1.6250	92.075 3.6250	55.562 2.1875	39.688 1.5625	174000 39100	0.78	0.86	1.29	25900 5810	34600 7770	45000 10100	0.75
43.658 1.7188	82.550 3.2500	44.450 1.7500	34.925 1.3750	135000 30300	0.43	1.57	2.34	20100 4510	14800 3320	35000 7860	1.36
44.450 1.7500	79.375 3.1250	41.272 1.6249	33.338 1.3125	90600 20400	0.37	1.80	2.69	13500 3030	8630 1940	23500 5280	1.56
44.450 1.7500	95.250 3.7500	61.915 2.4376	50.800 2.0000	221000 49700	0.28	2.37	3.53	32900 7400	16000 3600	57300 12900	2.05

⁽¹⁾Based on 1×10^6 revolutions L_{10} life, for the ISO life-calculation method. $C_{1(2)}$ is the double-row radial value.

⁽²⁾Consult your Timken engineer for instructions on use or review the Timken Engineering Manual on timken.com/catalogs.

⁽³⁾Based on 90×10^6 revolutions L_{10} life, for The Timken Company life-calculation method. C_{90} and C_{a90} are radial and thrust values for a single row. $C_{90(2)}$ is the double-row radial value.

Part Number		Dimensions						Bearing Weight
Inner	Outer	Shaft		Housing		Pin		
		Max Shaft Fillet Radius	Backing Shoulder Dia.	Max Housing Fillet Radius	Backing Shoulder Dia.	K _a	K _b	
		R ⁽⁴⁾	d _b	r ⁽⁴⁾	D _a			
mm	mm	mm	mm	mm	mm	mm	mm	kg
in.	in.	in.	in.	in.	in.	in.	in.	lbs.
NA05075	05185D	1.3 0.05	25.0 0.98	0.8 0.03	42.5 1.67	– –	– –	0.23 0.51
NA17098	17245D	1.5 0.06	33.0 1.30	0.8 0.03	57.0 2.24	– –	– –	0.62 1.36
NA41125	41294D	2.3 0.09	43.0 1.69	1.5 0.06	68.0 2.68	– –	– –	1.12 2.45
NA26118	26284D	1.5 0.06	38.0 1.50	0.8 0.03	65.0 2.56	– –	– –	0.84 1.87
NA08125	08231D	1.5 0.06	38.5 1.52	0.4 0.02	55.0 2.17	– –	– –	0.35 0.79
NA43131	43319D	2.3 0.09	48.5 1.91	1.5 0.06	74.0 2.91	– –	– –	1.28 2.82
NA14138	14276D	3.5 0.14	46.0 1.81	0.8 0.03	63.0 2.48	– –	– –	0.70 1.56
NA28138	28318D	1.5 0.06	43.5 1.71	0.8 0.03	73.0 2.87	– –	– –	1.04 2.32
NA44143	44363D	0.8 0.03	51.0 2.01	1.5 0.06	85.0 3.35	– –	– –	1.73 3.85
NA13687	13621D	2.0 0.08	46.5 1.83	0.8 0.03	65.0 2.56	– –	– –	0.67 1.48
NA44156	44348D	2.3 0.09	56.0 2.20	0.6 0.03	84.0 3.31	– –	– –	1.48 3.26
NA44156	44363D	2.3 0.09	56.0 2.20	1.5 0.06	85.0 3.35	– –	– –	1.65 3.65
NA357	353D	1.5 0.06	49.0 1.93	0.8 0.03	82.0 3.23	– –	– –	1.54 3.39
NA44163	44363D	0.8 0.03	54.0 2.13	1.5 0.06	85.0 3.35	– –	– –	1.61 3.57
NA22171	22325D	2.3 0.09	53.0 2.09	0.8 0.03	76.0 2.99	– –	– –	1.01 2.21
NA18685	18620D	2.8 0.11	54.0 2.13	0.8 0.03	74.0 2.91	– –	– –	0.80 1.75
NA438	432D	3.5 0.14	57.0 2.24	0.8 0.03	87.0 3.43	– –	– –	2.00 4.41

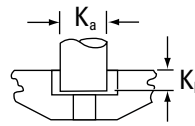
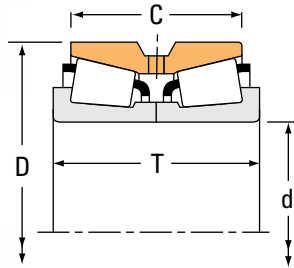
⁽⁴⁾These maximum fillet radii will be cleared by bearing corners.

NOTE: For desired fitting practice and resultant mounted setting range information, contact your Timken engineer.

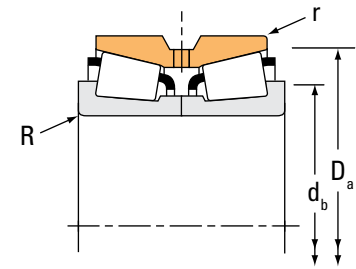
TAPERED ROLLER BEARINGS

DOUBLE-ROW • TYPE TNA

TYPE TNA



Locking pin for CD outer ring.



Bearing Dimensions				Load Ratings							
Bore d	O.D. D	Width T	Double Outer Ring Width C	Dynamic ⁽¹⁾		Factors ⁽²⁾		Dynamic ⁽³⁾			Factors ⁽²⁾
				C ₁₍₂₎	e	Y ₁	Y ₂	C ₉₀	C _{a90}	C ₉₀₍₂₎	K
mm in.	mm in.	mm in.	mm in.	N lbf				N lbf	N lbf	N lbf	
44.450 1.7500	95.250 3.7500	65.090 2.5626	44.450 1.7500	174000 39200	0.74	0.91	1.36	26000 5840	32900 7390	45200 10200	0.79
44.450 1.7500	98.425 3.8750	65.090 2.5626	44.450 1.7500	174000 39200	0.74	0.91	1.36	26000 5840	32900 7390	45200 10200	0.79
50.000 1.9685	90.000 3.5433	50.010 1.9689	42.070 1.6563	177000 39900	0.32	2.11	3.14	26400 5930	14400 3250	46000 10300	1.83
50.800 2.0000	93.264 3.6718	65.088 2.5625	52.388 2.0625	213000 47800	0.34	1.99	2.97	31700 7120	18300 4120	55100 12400	1.73
50.800 2.0000	107.950 4.2500	65.090 2.5626	53.975 2.1250	236000 53100	0.34	2.01	3.00	35200 7900	20200 4540	61200 13800	1.74
50.800 2.0000	112.712 4.4375	65.088 2.5625	46.038 1.8125	185000 41600	0.88	0.76	1.14	27600 6200	41700 9380	48000 10800	0.66
53.975 2.1250	111.125 4.3750	79.375 3.1250	63.500 2.5000	300000 67400	0.30	2.28	3.39	44600 10000	22700 5090	77700 17500	1.97
53.975 2.1250	117.475 4.6250	73.025 2.8750	53.975 2.1250	259000 58300	0.63	1.08	1.60	38600 8680	41400 9310	67200 15100	0.93
53.975 2.1250	123.825 4.8750	77.788 3.0625	55.562 2.1875	287000 64600	0.74	0.92	1.36	42800 9620	54000 12100	74500 16800	0.79
55.000 2.1654	100.000 3.9370	52.388 2.0625	42.862 1.6875	188000 42200	0.35	1.91	2.84	28000 6280	16900 3810	48700 10900	1.65
60.000 2.3622	110.000 4.3307	52.388 2.0625	46.038 1.8125	172000 38700	0.40	1.68	2.50	25600 5760	17600 3970	44600 10000	1.45
60.000 2.3622	120.000 4.7244	65.090 2.5626	53.975 2.1250	250000 56100	0.38	1.75	2.61	37200 8360	24500 5500	64700 14600	1.52
60.325 2.3750	123.825 4.8750	79.375 3.1250	63.500 2.5000	332000 74700	0.35	1.95	2.90	49400 11100	29300 6590	86100 19400	1.69
63.500 2.5000	139.700 5.5000	77.788 3.0625	51.803 2.0395	353000 79300	0.87	0.78	1.16	52600 11800	77900 17500	91500 20600	0.67
66.675 2.6250	127.000 5.0000	80.962 3.1875	65.088 2.5625	342000 76900	0.36	1.86	2.76	50900 11400	31700 7130	88600 19900	1.61
69.850 2.7500	120.000 4.7244	65.090 2.5626	53.975 2.1250	250000 56100	0.38	1.75	2.61	37200 8360	24500 5500	64700 14600	1.52
69.850 2.7500	136.525 5.3750	95.250 3.7500	76.200 3.0000	406000 91200	0.36	1.86	2.78	60400 13600	37400 8420	105000 23600	1.61

⁽¹⁾Based on 1×10^6 revolutions L_{10} life, for the ISO life-calculation method. $C_{1(2)}$ is the double-row radial value.

⁽²⁾Consult your Timken engineer for instructions on use or review the Timken Engineering Manual on timken.com/catalogs.

⁽³⁾Based on 90×10^6 revolutions L_{10} life, for The Timken Company life-calculation method. C_{90} and C_{a90} are radial and thrust values for a single row. $C_{90(2)}$ is the double-row radial value.

Part Number		Dimensions						Bearing Weight
Inner	Outer	Shaft		Housing		Pin		
		Max Shaft Fillet Radius	Backing Shoulder Dia.	Max Housing Fillet Radius	Backing Shoulder Dia.	K _a	K _b	
		R ⁽⁴⁾	d _b	r ⁽⁴⁾	D _a			
mm in.	mm in.	mm in.	mm in.	mm in.	mm in.	kg lbs.		
NA53176	53376D	2.3 0.09	61.0 2.40	0.8 0.03	89.0 3.50	– –	– –	1.92 4.21
NA53176	53390D	2.3 0.09	61.0 2.40	1.5 0.06	90.0 3.54	– –	– –	2.10 4.62
NA366	363D	3.5 0.14	61.0 2.40	0.8 0.03	84.0 3.31	– –	– –	1.18 2.61
NA3780	3729D	3.5 0.14	64.0 2.52	0.8 0.03	87.9 3.46	– –	– –	1.83 4.02
NA455	452D	3.5 0.14	65.0 2.56	0.8 0.03	100.0 3.94	– –	– –	2.76 6.10
NA55200	55444D	2.3 0.09	69.0 2.72	1.5 0.06	105.0 4.13	– –	– –	2.85 6.25
NA539	533D	3.5 0.14	68.0 2.68	1.5 0.06	100.0 3.94	– –	– –	3.35 7.39
NA66212	66462D	3.5 0.14	73.0 2.87	0.8 0.03	111.0 4.37	– –	– –	3.56 7.82
NA72212	72488D	2.3 0.09	74.0 2.91	1.5 0.06	115.0 4.53	– –	– –	4.08 9.00
NA385	384CD	3.5 0.14	67.0 2.64	0.8 0.03	93.0 3.66	7.94 0.31	4.77 0.19	1.56 3.45
NA397	394D	3.5 0.14	74.0 2.91	0.8 0.03	104.4 4.11	– –	– –	2.04 4.51
NA476	472D	3.5 0.14	76.0 2.99	0.8 0.03	114.0 4.49	– –	– –	3.45 7.59
NA558	552D	3.5 0.14	76.0 2.99	1.5 0.06	115.0 4.53	– –	– –	4.31 9.50
NA78250	78549D	2.3 0.09	85.0 3.35	1.5 0.06	131.0 5.16	– –	– –	5.11 11.28
NA569	563D	3.5 0.14	82.0 3.23	1.5 0.06	119.0 4.69	– –	– –	4.36 9.64
NA482	472D	3.5 0.14	83.0 3.27	0.8 0.03	114.0 4.49	– –	– –	2.93 6.46
NA643	632D	3.5 0.14	86.0 3.39	1.5 0.06	125.0 4.92	– –	– –	5.88 12.92

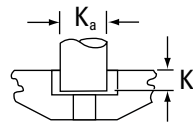
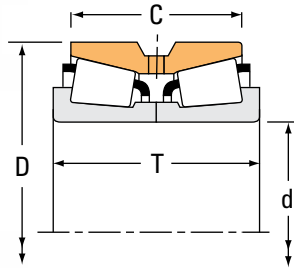
⁽⁴⁾These maximum fillet radii will be cleared by bearing corners.

NOTE: For desired fitting practice and resultant mounted setting range information, contact your Timken engineer.

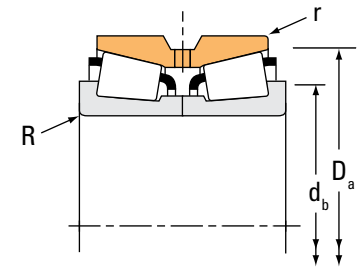
TAPERED ROLLER BEARINGS

DOUBLE-ROW • TYPE TNA

TYPE TNA



Locking pin for CD outer ring.



Bearing Dimensions				Load Ratings							
Bore d	O.D. D	Width T	Double Outer Ring Width C	Dynamic ⁽¹⁾		Factors ⁽²⁾		Dynamic ⁽³⁾			Factors ⁽²⁾
				C ₁₍₂₎	e	Y ₁	Y ₂	C ₉₀	C _{a90}	C ₉₀₍₂₎	K
mm in.	mm in.	mm in.	mm in.	N lbf				N lbf	N lbf	N lbf	
70.000 2.7559	120.000 4.7244	65.090 2.5626	53.975 2.1250	250000 56100	0.38	1.75	2.61	37200 8360	24500 5500	64700 14600	1.52
73.025 2.8750	127.000 5.0000	80.962 3.1875	65.088 2.5625	342000 76900	0.36	1.86	2.76	50900 11400	31700 7130	88600 19900	1.61
76.200 3.0000	136.525 5.3750	69.850 2.7500	53.975 2.1250	269000 60500	0.44	1.52	2.26	40000 9000	30500 6850	69700 15700	1.31
76.200 3.0000	152.400 6.0000	95.250 3.7500	76.200 3.0000	430000 96700	0.41	1.65	2.46	64000 14400	44800 10100	112000 25100	1.43
76.200 3.0000	177.800 7.0000	109.538 4.3125	74.612 2.9375	632000 142000	0.76	0.88	1.31	94100 21200	123000 27700	164000 36800	0.76
82.550 3.2500	139.992 5.5115	82.550 3.2500	66.675 2.6250	360000 80900	0.40	1.67	2.49	53600 12100	37100 8330	93400 21000	1.45
82.550 3.2500	155.575 6.1250	101.600 4.0000	85.725 3.3750	656000 147000	0.33	2.08	3.09	97600 21900	54400 12200	170000 38200	1.80
82.550 3.2500	171.450 6.7500	125.412 4.9375	100.012 3.9375	712000 160000	0.30	2.26	3.36	106000 23800	54300 12200	185000 41500	1.95
88.900 3.5000	152.400 6.0000	82.550 3.2500	63.500 2.5000	376000 84600	0.44	1.53	2.27	56000 12600	42400 9530	97500 21900	1.32
88.900 3.5000	161.925 6.3750	104.775 4.1250	85.725 3.3750	570000 128000	0.34	1.98	2.95	84800 19100	49500 11100	148000 33200	1.71
88.900 3.5000	200.025 7.8750	115.888 4.5625	80.216 3.1581	708000 159000	0.63	1.07	1.59	105000 23700	114000 25600	183000 41200	0.92
95.250 3.7500	161.925 6.3750	82.547 3.2499	61.912 2.4375	389000 87500	0.47	1.42	2.12	57900 13000	47100 10600	101000 22700	1.23
95.250 3.7500	180.975 7.1250	104.775 4.1250	85.725 3.3750	603000 135000	0.39	1.75	2.61	89700 20200	59200 13300	156000 35100	1.51
100.000 3.9370	168.275 6.6250	92.075 3.6250	69.850 2.7500	461000 104000	0.47	1.43	2.14	68600 15400	55300 12400	119000 26900	1.24
101.600 4.0000	168.275 6.6250	92.075 3.6250	69.850 2.7500	461000 104000	0.47	1.43	2.14	68600 15400	55300 12400	119000 26900	1.24
101.600 4.0000	180.000 7.0866	104.775 4.1250	85.725 3.3750	603000 135000	0.39	1.75	2.61	89700 20200	59200 13300	156000 35100	1.51
101.600 4.0000	180.975 7.1250	104.775 4.1250	85.725 3.3750	603000 135000	0.39	1.75	2.61	89700 20200	59200 13300	156000 35100	1.51

⁽¹⁾Based on 1×10^6 revolutions L_{10} life, for the ISO life-calculation method. $C_{1(2)}$ is the double-row radial value.

⁽²⁾Consult your Timken engineer for instructions on use or review the Timken Engineering Manual on timken.com/catalogs.

⁽³⁾Based on 90×10^6 revolutions L_{10} life, for The Timken Company life-calculation method. C_{90} and C_{a90} are radial and thrust values for a single row. $C_{90(2)}$ is the double-row radial value.

Part Number		Dimensions						Bearing Weight
Inner	Outer	Shaft		Housing		Pin		
		Max Shaft Fillet Radius	Backing Shoulder Dia.	Max Housing Fillet Radius	Backing Shoulder Dia.	K _a	K _b	
		R ⁽⁴⁾	d _b	r ⁽⁴⁾	D _a			
mm in.	mm in.	mm in.	mm in.	mm in.	mm in.	mm in.	kg lbs.	
NA484	472D	3.5 0.14	83.0 3.27	0.8 0.03	114.0 4.49	– –	– –	2.93 6.44
NA567	563D	6.8 0.27	94.0 3.70	1.5 0.06	119.0 4.69	– –	– –	3.86 8.52
NA495A	493D	3.5 0.14	92.0 3.62	0.8 0.03	130.0 5.12	– –	– –	4.14 9.12
NA659	654D	3.5 0.14	93.0 3.66	1.5 0.06	141.0 5.55	– –	– –	7.61 16.77
NA9378	9320D	3.5 0.14	105.0 4.13	2.3 0.09	164.0 6.46	– –	– –	12.34 27.20
NA580	572D	3.5 0.14	98.0 3.86	0.8 0.03	133.0 5.24	– –	– –	4.79 10.56
NA749	742D	3.5 0.14	99.0 3.90	1.5 0.06	143.0 5.63	– –	– –	8.17 18.01
NA842	834D	3.5 0.14	101.0 3.98	0.8 0.03	155.0 6.10	– –	– –	13.10 28.88
NA593	592D	3.5 0.14	104.0 4.09	0.8 0.03	144.0 5.67	– –	– –	5.87 12.93
NA759	752D	3.5 0.14	106.0 4.17	1.5 0.06	150.0 5.91	– –	– –	8.76 19.28
NA98350	98789D	3.5 0.14	118.0 4.65	2.3 0.09	188.0 7.40	– –	– –	16.57 36.50
NA52375	52637D	3.5 0.14	112.0 4.41	0.8 0.03	154.0 6.06	– –	– –	6.53 14.41
NA776	774CD	3.5 0.14	114.0 4.49	1.5 0.06	168.0 6.61	19.05 0.75	7.13 0.28	11.44 25.21
NA691A	672D	3.5 0.14	119.0 4.69	0.8 0.03	160.0 6.30	– –	– –	7.62 16.78
NA691	672D	3.5 0.14	118.0 4.65	0.8 0.03	160.0 6.30	– –	– –	7.58 16.69
NA780	773D	3.5 0.14	119.0 4.69	0.8 0.03	168.0 6.61	– –	– –	10.67 23.56
NA780	774CD	3.5 0.14	119.0 4.69	1.5 0.06	168.0 6.61	19.05 0.75	7.13 0.28	10.62 23.43

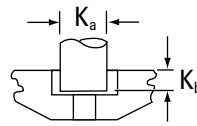
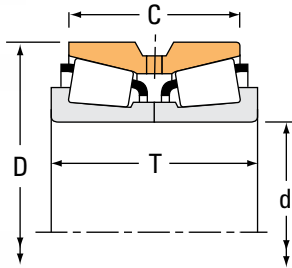
⁽⁴⁾These maximum fillet radii will be cleared by bearing corners.

NOTE: For desired fitting practice and resultant mounted setting range information, contact your Timken engineer.

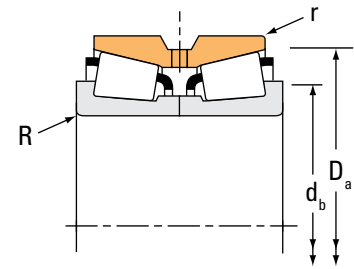
TAPERED ROLLER BEARINGS

DOUBLE-ROW • TYPE TNA

TYPE TNA



Locking pin for CD outer ring.



Bearing Dimensions				Load Ratings							
Bore d	O.D. D	Width T	Double Outer Ring Width C	Dynamic ⁽¹⁾				Dynamic ⁽³⁾			
				C ₁₍₂₎	e	Factors ⁽²⁾ Y ₁	Y ₂	C ₉₀	C _{a90}	C ₉₀₍₂₎	Factors ⁽²⁾ K
mm in.	mm in.	mm in.	mm in.	N lbf				N lbf	N lbf	N lbf	
101.600 4.0000	190.500 7.5000	127.000 5.0000	101.600 4.0000	797000 179000	0.33	2.02	3.00	119000 26700	68000 15300	207000 46400	1.74
101.600 4.0000	190.500 7.5000	127.000 5.0000	104.775 4.1250	929000 209000	0.33	2.02	3.00	138000 31100	79300 17800	241000 54200	1.74
104.775 4.1250	180.975 7.1250	104.775 4.1250	85.725 3.3750	603000 135000	0.39	1.75	2.61	89700 20200	59200 13300	156000 35100	1.51
114.300 4.5000	190.500 7.5000	106.362 4.1875	80.962 3.1875	633000 142000	0.42	1.62	2.42	94300 21200	67100 15100	164000 36900	1.40
114.300 4.5000	228.600 9.0000	115.888 4.5625	84.138 3.3125	655000 147000	0.74	0.92	1.36	97500 21900	123000 27600	170000 38200	0.79
114.300 4.5000	228.600 9.0000	115.888 4.5625	84.138 3.3125	862000 194000	0.74	0.92	1.36	128000 28800	162000 36400	223000 50200	0.79
127.000 5.0000	182.562 7.1875	85.725 3.3750	73.025 2.8750	466000 105000	0.31	2.21	3.29	69400 15600	36300 8160	121000 27200	1.91
133.350 5.2500	190.500 7.5000	85.725 3.3750	73.025 2.8750	492000 111000	0.32	2.10	3.13	73300 16500	40300 9060	128000 28700	1.82
142.875 5.6250	200.025 7.8750	93.665 3.6876	73.025 2.8750	499000 112000	0.34	2.01	2.99	74300 16700	42800 9610	129000 29100	1.74
146.050 5.7500	236.538 9.3125	131.762 5.1875	106.362 4.1875	897000 202000	0.44	1.53	2.27	134000 30000	101000 22700	232000 52300	1.32
146.050 5.7500	241.300 9.5000	131.762 5.1875	106.362 4.1875	1040000 234000	0.32	2.12	3.15	155000 34800	84500 19000	269000 60600	1.83
149.225 5.8750	236.538 9.3125	131.762 5.1875	106.362 4.1875	897000 202000	0.44	1.53	2.27	134000 30000	101000 22700	232000 52300	1.32
149.225 5.8750	241.300 9.5000	131.762 5.1875	106.362 4.1875	1040000 234000	0.32	2.12	3.15	155000 34800	84500 19000	269000 60600	1.83
150.967 5.9436	229.873 9.0501	108.000 4.2520	116.000 4.5669	597000 134000	0.33	2.03	3.02	88900 20000	50600 11400	155000 34800	1.76
152.400 6.0000	254.000 10.0000	142.875 5.6250	111.125 4.3750	1150000 258000	0.41	1.66	2.47	171000 38500	119000 26800	298000 67000	1.43
165.100 6.5000	298.450 11.7500	142.875 5.6250	111.125 4.3750	1150000 258000	0.47	1.44	2.15	171000 38500	137000 30800	298000 67000	1.25
177.800 7.0000	282.575 11.1250	107.950 4.2500	79.375 3.1250	748000 168000	0.42	1.62	2.42	132000 29700	93900 21100	230000 51700	1.41

⁽¹⁾Based on 1×10^6 revolutions L_{10} life, for the ISO life-calculation method. $C_{1(2)}$ is the double-row radial value.

⁽²⁾Consult your Timken engineer for instructions on use or review the Timken Engineering Manual on timken.com/catalogs.

⁽³⁾Based on 90×10^6 revolutions L_{10} life, for The Timken Company life-calculation method. C_{90} and C_{a90} are radial and thrust values for a single row. $C_{90(2)}$ is the double-row radial value.

Part Number		Dimensions						Bearing Weight
Inner	Outer	Shaft		Housing		Pin		
		Max Shaft Fillet Radius	Backing Shoulder Dia.	Max Housing Fillet Radius	Backing Shoulder Dia.	K _a	K _b	
		R ⁽⁴⁾	d _b	r ⁽⁴⁾	D _a			
mm in.	mm in.	mm in.	mm in.	mm in.	mm in.	kg lbs.		
NA861	854D	3.5 0.14	120.0 4.72	1.5 0.06	174.0 6.85	– –	– –	14.98 33.03
HH221449NA	HH221410D	3.5 0.14	122.0 4.80	1.5 0.06	179.0 7.05	– –	– –	14.81 32.64
NA782	774CD	3.5 0.14	122.0 4.80	1.5 0.06	168.0 6.61	19.05 0.75	7.13 0.28	10.20 22.50
NA71450	71751D	3.5 0.14	132.0 5.20	1.5 0.06	181.0 7.13	– –	– –	11.08 24.43
NA97450	97901D	3.5 0.14	140.0 5.51	2.3 0.09	213.0 8.38	– –	– –	19.81 43.70
HM926740NA	HM926710CD	3.5 0.14	146.0 5.75	2.3 0.09	219.3 8.63	19.05 0.75	8.73 0.34	20.61 45.41
NA48291	48220D	3.5 0.14	141.0 5.55	0.8 0.03	176.0 6.93	– –	– –	7.13 15.71
NA48385	48320D	3.5 0.14	148.0 5.83	0.8 0.03	184.0 7.24	– –	– –	7.45 16.45
NA48686	48620D	3.5 0.14	158.0 6.22	0.8 0.03	193.0 7.60	– –	– –	8.41 18.56
NA82576	82932D	3.5 0.14	166.0 6.54	1.5 0.06	226.0 8.90	– –	– –	20.60 45.41
HM231140NA	HM231116D	3.5 0.14	164.0 6.46	1.5 0.06	224.0 8.82	– –	– –	22.00 48.50
NA82587	82932D	3.5 0.14	169.0 6.65	1.5 0.06	226.0 8.90	– –	– –	19.82 43.73
HM231149NA	HM231116D	3.5 0.14	167.0 6.57	1.5 0.06	224.0 8.82	– –	– –	21.24 46.82
M231647	M231616XD	3.5 0.14	168.0 6.61	** **	222.0 8.74	– –	– –	16.14 35.57
NA99600	99102CD	3.5 0.14	177.0 6.97	1.5 0.06	238.0 9.37	0.87	0.31	26.54 58.51
NA94650	94118D	3.5 0.14	190.0 7.48	1.5 0.06	272.0 10.71	– –	– –	41.69 91.93
NA87700	87112D	3.5 0.14	200.0 7.87	1.5 0.06	267.0 10.50	– –	– –	23.05 50.80

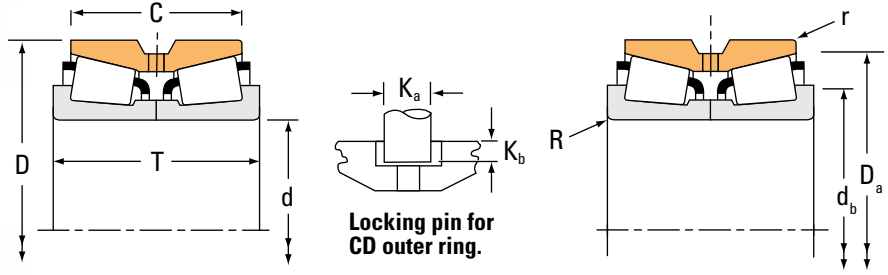
⁽⁴⁾These maximum fillet radii will be cleared by bearing corners.

NOTE: For desired fitting practice and resultant mounted setting range information, contact your Timken engineer.

TAPERED ROLLER BEARINGS

DOUBLE-ROW • TYPE TNA

TYPE TNA



Bearing Dimensions				Load Ratings							
Bore d	O.D. D	Width T	Double Outer Ring Width C	Dynamic ⁽¹⁾				Dynamic ⁽³⁾			
				C ₁₍₂₎	e	Factors ⁽²⁾ Y ₁	Y ₂	C ₉₀	C _{a90}	C ₉₀₍₂₎	Factors ⁽²⁾ K
mm in.	mm in.	mm in.	mm in.	N lbf				N lbf	N lbf	N lbf	
177.800 7.0000	298.450 11.7500	142.875 5.6250	139.700 5.5000	1150000 258000	0.47	1.44	2.15	171000 38500	137000 30800	298000 67000	1.25
177.800 7.0000	298.450 11.7500	142.875 5.6250	111.125 4.3750	1150000 258000	0.47	1.44	2.15	171000 38500	137000 30800	298000 67000	1.25
190.500 7.5000	260.350 10.2500	66.675 2.6250	50.800 2.0000	410000 92100	0.34	1.97	2.93	61000 13700	35800 8040	106000 23900	1.70
203.200 8.0000	317.500 12.5000	120.650 4.7500	88.900 3.5000	919000 207000	0.31	2.15	3.21	137000 30800	73400 16500	238000 53600	1.86
254.000 10.0000	422.275 16.6250	173.038 6.8125	128.588 5.0625	2610000 587000	0.33	2.03	3.02	389000 87400	221000 49700	677000 152000	1.76
254.000 10.0000	431.724 16.9970	173.038 6.8125	128.588 5.0625	2690000 605000	0.33	2.03	3.02	401000 90100	228000 51300	698000 157000	1.76
254.000 10.0000	431.724 16.9970	173.038 6.8125	128.588 5.0625	2610000 587000	0.33	2.03	3.02	389000 87400	221000 49700	677000 152000	1.76
260.350 10.2500	422.275 16.6250	173.038 6.8125	128.588 5.0625	2690000 605000	0.33	2.03	3.02	401000 90100	228000 51300	698000 157000	1.76
260.350 10.2500	422.275 16.6250	173.038 6.8125	128.588 5.0625	2610000 587000	0.33	2.03	3.02	389000 87400	221000 49700	677000 152000	1.76
260.350 10.2500	431.724 16.9970	173.038 6.8125	128.588 5.0625	2690000 605000	0.33	2.03	3.02	401000 90100	228000 51300	698000 157000	1.76
260.350 10.2500	431.724 16.9970	173.038 6.8125	128.588 5.0625	2610000 587000	0.33	2.03	3.02	389000 87400	221000 49700	677000 152000	1.76
300.787 11.8420	438.048 17.2460	161.925 6.3750	123.825 4.8750	1880000 422000	0.33	2.04	3.03	280000 62900	159000 35700	487000 110000	1.76
300.787 11.8420	438.048 17.2460	161.925 6.3750	123.825 4.8750	1920000 432000	0.33	2.04	3.03	286000 64300	162000 36500	498000 112000	1.76
300.787 11.8420	444.500 17.5000	161.925 6.3750	161.925 6.3750	1880000 422000	0.33	2.04	3.03	280000 62900	159000 35700	487000 110000	1.76
304.800 12.0000	438.048 17.2460	161.925 6.3750	123.825 4.8750	1880000 422000	0.33	2.04	3.03	280000 62900	159000 35700	487000 110000	1.76
304.800 12.0000	438.048 17.2460	161.925 6.3750	123.825 4.8750	1920000 432000	0.33	2.04	3.03	286000 64300	162000 36500	498000 112000	1.76
355.600 14.0000	514.350 20.2500	146.050 5.7500	107.950 4.2500	1830000 412000	0.44	1.53	2.28	273000 61300	206000 46200	475000 107000	1.33
406.400 16.0000	574.675 22.6250	157.162 6.1875	106.362 4.1875	1930000 434000	0.50	1.36	2.02	287000 64600	245000 55000	500000 112000	1.17

⁽¹⁾Based on 1 x 10⁶ revolutions L₁₀ life, for the ISO life-calculation method. C₁₍₂₎ is the double-row radial value.

⁽²⁾Consult your Timken engineer for instructions on use or review the Timken Engineering Manual on timken.com/catalogs.

⁽³⁾Based on 90 x 10⁶ revolutions L₁₀ life, for The Timken Company life-calculation method. C₉₀ and C_{a90} are radial and thrust values for a single row. C₉₀₍₂₎ is the double-row radial value.

Part Number		Dimensions						Bearing Weight
Inner	Outer	Shaft		Housing		Pin		
		Max Shaft Fillet Radius	Backing Shoulder Dia.	Max Housing Fillet Radius	Backing Shoulder Dia.	K _a	K _b	
		R ⁽⁴⁾	d _b	r ⁽⁴⁾	D _a			
mm	mm	mm	mm	mm	mm	mm	mm	kg
in.	in.	in.	in.	in.	in.	in.	in.	lbs.
NA94700	94117D	5.5 0.22	203.0 7.99	1.5 0.06	279.0 10.98	–	–	40.07 88.35
NA94700	94118D	5.5 0.22	203.0 7.99	1.5 0.06	272.0 10.71	–	–	37.85 83.46
NA537075	537103D	3.5 0.14	206.0 8.11	0.8 0.03	246.9 9.72	–	–	9.54 21.00
NA132083	132126D	6.4 0.25	230.1 9.06	1.5 0.06	293.1 11.54	–	–	33.51 73.89
HM252343NA	HM252311D	6.4 0.25	286.0 11.26	1.5 0.06	400.0 15.73	–	–	85.70 188.93
HM252344NA	HM252315CD	6.4 0.25	286.0 11.26	1.5 0.06	398.3 15.68	28.58 1.13	11.91 0.47	96.42 212.55
HM252343NA	HM252315CD	6.4 0.25	286.0 11.26	1.5 0.06	398.3 15.68	28.58 1.13	11.91 0.47	92.05 202.94
HM252349NA	HM252311D	6.4 0.25	291.0 11.46	1.5 0.06	400.0 15.73	–	–	86.59 190.86
HM252348NA	HM252311D	6.4 0.25	291.0 11.46	1.5 0.06	400.0 15.73	–	–	82.22 181.24
HM252349NA	HM252315CD	6.4 0.25	291.0 11.46	1.5 0.06	398.3 15.68	28.58 1.13	11.91 0.47	92.94 204.87
HM252348NA	HM252315CD	6.4 0.25	291.0 11.46	1.5 0.06	398.3 15.68	28.58 1.13	11.91 0.47	88.57 195.25
NA329116	329173CD	6.4 0.25	330.0 12.99	1.5 0.06	414.1 16.30	22.23 0.88	11.12 0.44	73.86 162.84
NA329115	329173CD	6.4 0.25	330.0 12.99	1.5 0.06	414.1 16.30	22.23 0.88	11.12 0.44	75.86 167.26
NA329116	329176D	6.4 0.25	330.0 12.99	1.5 0.06	422.5 16.64	–	–	83.75 184.65
NA329120	329173CD	6.4 0.25	333.0 13.11	1.5 0.06	414.1 16.30	22.23 0.88	11.12 0.44	71.44 157.49
NA329121	329173CD	6.4 0.25	333.0 13.11	1.5 0.06	414.1 16.30	22.23 0.88	11.12 0.44	73.44 161.91
NA231400	232026D	6.4 0.25	388.0 15.28	1.5 0.06	481.1 18.94	–	–	91.10 200.84
NA285160	285228D	6.4 0.25	441.0 17.36	1.5 0.06	534.0 21.02	–	–	112.79 248.66

⁽⁴⁾These maximum fillet radii will be cleared by bearing corners.

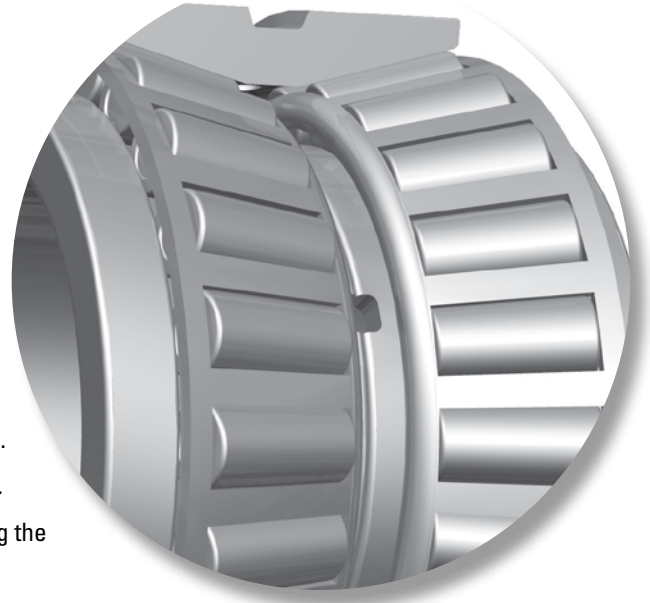
NOTE: For desired fitting practice and resultant mounted setting range information, contact your Timken engineer.

TAPERED ROLLER BEARINGS

DOUBLE ROW • TYPE TNASW • TYPE TNASWE

TYPE TNASW AND TYPE TNASWE

- TNASW double-row bearings are a variant of type TNA, having chamfers and slots on the front face of the inner ring.
- TNASWE has an extended inner ring face.
- Slots on the inner ring provide lubrication.
- Cone front faces are extended, eliminating the need for a separate cone spacer.
- TNASW and TNASWE bearings are supplied with a built-in clearance, which results in a specified mounted setting range satisfactory for most applications.
- Types TNASW and TNASWE provide a solution for fixed or floating bearing applications.
- Consult your Timken engineer before making a final bearing selection to help ensure suitability, availability and the most cost-effective solution.



Type TNASW

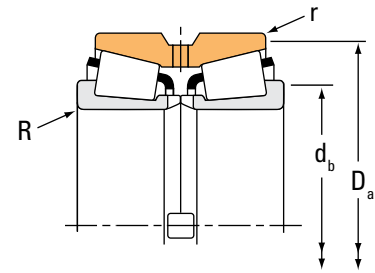
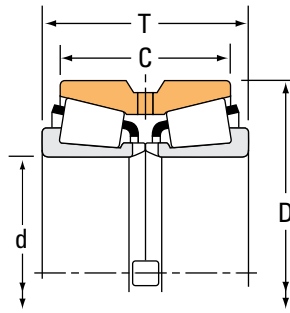


Type TNASWE

TAPERED ROLLER BEARINGS

DOUBLE-ROW • TYPE TNASW

TYPE TNASW



Bearing Dimensions				Load Ratings							
Bore d	O.D. D	Width T	Double Outer Ring Width C	Dynamic ⁽¹⁾				Dynamic ⁽³⁾			
				C ₁₍₂₎	e	Factors ⁽²⁾ Y ₁	Y ₂	C ₉₀	C _{a90}	C ₉₀₍₂₎	Factors ⁽²⁾ K
mm in.	mm in.	mm in.	mm in.	N lbf				N lbf	N lbf	N lbf	
29.987 1.1806	71.973 2.8336	42.760 1.6835	36.512 1.4375	121000 27300	0.36	1.87	2.79	18100 4060	11100 2500	31400 7070	1.62
44.450 1.7500	95.250 3.7500	61.915 2.4376	50.800 2.0000	221000 49700	0.28	2.37	3.53	32900 7400	16000 3600	57300 12900	2.05
50.800 2.0000	93.264 3.6718	65.088 2.5625	52.388 2.0625	213000 47800	0.34	1.99	2.97	31700 7120	18300 4120	55100 12400	1.73
50.800 2.0000	107.950 4.2500	65.090 2.5626	53.975 2.1250	236000 53100	0.34	2.01	3.00	35200 7900	20200 4540	61200 13800	1.74
53.975 2.1250	127.000 5.0000	69.850 2.7500	68.265 2.6876	226000 50800	0.33	2.05	3.05	33600 7560	19000 4270	58600 13200	1.77
60.325 2.3750	123.825 4.8750	79.375 3.1250	63.500 2.5000	332000 74700	0.35	1.95	2.90	49400 11100	29300 6590	86100 19400	1.69
69.850 2.7500	136.525 5.3750	95.250 3.7500	76.200 3.0000	406000 91200	0.36	1.86	2.78	60400 13600	37400 8420	105000 23600	1.61
70.000 2.7559	120.000 4.7244	65.090 2.5626	53.975 2.1250	250000 56100	0.38	1.75	2.61	37200 8360	24500 5500	64700 14600	1.52
76.200 3.0000	136.525 5.3750	69.850 2.7500	53.975 2.1250	269000 60500	0.44	1.52	2.26	40000 9000	30500 6850	69700 15700	1.31
76.200 3.0000	152.400 6.0000	95.250 3.7500	76.200 3.0000	430000 96700	0.41	1.65	2.46	64000 14400	44800 10100	112000 25100	1.43
85.725 3.3750	136.525 5.3750	73.025 2.8750	53.975 2.1250	254000 57100	0.44	1.52	2.26	37800 8500	28800 6470	65800 14800	1.31
88.900 3.5000	152.400 6.0000	82.550 3.2500	63.500 2.5000	376000 84600	0.44	1.53	2.27	56000 12600	42400 9530	97500 21900	1.32
88.900 3.5000	161.925 6.3750	104.775 4.1250	85.725 3.3750	570000 128000	0.34	1.98	2.95	84800 19100	49500 11100	148000 33200	1.71
95.250 3.7500	180.000 7.0866	104.775 4.1250	85.725 3.3750	603000 135000	0.39	1.75	2.61	89700 20200	59200 13300	156000 35100	1.51
95.250 3.7500	180.975 7.1250	104.775 4.1250	85.725 3.3750	603000 135000	0.39	1.75	2.61	89700 20200	59200 13300	156000 35100	1.51
101.600 4.0000	168.275 6.6250	92.075 3.6250	69.850 2.7500	461000 104000	0.47	1.43	2.14	68600 15400	55300 12400	119000 26900	1.24
234.950 9.2500	325.438 12.8125	107.950 4.2500	76.200 3.0000	929000 209000	0.33	2.02	3.01	138000 31100	79200 17800	241000 54200	1.75

⁽¹⁾Based on 1 x 10⁶ revolutions L₁₀ life, for the ISO life-calculation method. C₁₍₂₎ is the double-row radial value.

⁽²⁾Consult your Timken engineer for instructions on use or review the Timken Engineering Manual on timken.com/catalogs.

⁽³⁾Based on 90 x 10⁶ revolutions L₁₀ life, for The Timken Company life-calculation method. C₉₀ and C_{a90} are radial and thrust values for a single row. C₉₀₍₂₎ is the double-row radial value.

Part Number		Dimensions				Bearing Weight
Inner	Outer	Shaft		Housing		
		Max Shaft Fillet Radius R ⁽⁴⁾	Backing Shoulder Dia. d _b	Max Housing Fillet Radius r ⁽⁴⁾	Backing Shoulder Dia. D _a	
		mm in.	mm in.	mm in.	mm in.	kg lbs.
NA26118SW	26284D	1.5 0.06	38.0 1.50	0.8 0.03	65.0 2.56	0.84 1.86
NA438SW	432D	3.5 0.14	57.0 2.24	0.8 0.03	87.0 3.43	2.00 4.40
NA3780SW	3729D	3.5 0.14	64.0 2.52	0.8 0.03	87.9 3.46	1.81 3.99
NA455SW	452D	3.5 0.14	65.0 2.56	0.8 0.03	100.0 3.94	2.80 6.20
NA33895SW	K302667	3.5 0.14	67.0 2.64	6.4 0.25	93.0 3.66	4.83 10.64
NA558SW	552D	3.5 0.14	76.0 2.99	1.5 0.06	115.0 4.53	4.33 9.57
NA643SW	632D	3.5 0.14	86.0 3.39	1.5 0.06	125.0 4.92	5.92 13.01
NA484SW	472D	3.5 0.14	83.0 3.27	0.8 0.03	114.0 4.49	2.91 6.39
NA495SW	493D	3.5 0.14	92.0 3.62	0.8 0.03	130.0 5.12	4.08 8.97
NA659SW	654D	3.5 0.14	93.0 3.66	1.5 0.06	141.0 5.55	7.63 16.83
NA497SW	493D	3.5 0.14	99.0 3.90	0.8 0.03	130.0 5.12	3.56 7.84
NA593SW	592D	3.5 0.14	104.0 4.09	0.8 0.03	144.0 5.67	5.81 12.82
NA759SW	752D	3.5 0.14	106.0 4.17	1.5 0.06	150.0 5.91	8.80 19.38
NA776SW	773D	3.5 0.14	114.0 4.49	0.8 0.03	168.0 6.61	11.49 25.34
NA776SW	774D	3.5 0.14	114.0 4.49	1.5 0.06	168.0 6.61	11.44 25.21
NA691SW	672D	3.5 0.14	118.0 4.65	0.8 0.03	160.0 6.30	7.82 17.23
LM246349NW	LM246310D	3.5 0.14	252.0 9.92	1.5 0.06	312.0 12.28	23.01 50.70

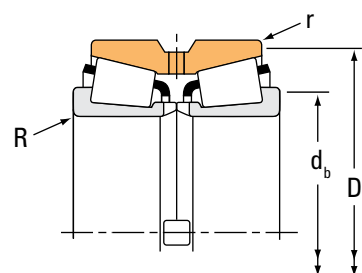
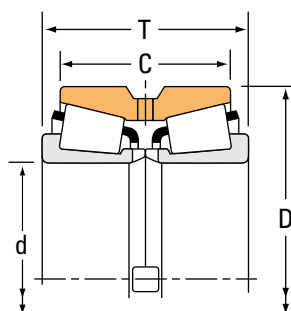
⁽⁴⁾These maximum fillet radii will be cleared by bearing corners.

NOTE: For desired fitting practice and resultant mounted setting range information, contact your Timken engineer.

TAPERED ROLLER BEARINGS

DOUBLE-ROW TYPE TNASW

TYPE TNASW



Bearing Dimensions				Load Ratings							
Bore d	O.D. D	Width T	Double Outer Ring Width C	Dynamic ⁽¹⁾				Dynamic ⁽³⁾			
				C ₁₍₂₎	e	Y ₁	Y ₂	C ₉₀	C _{a90}	C ₉₀₍₂₎	K
mm in.	mm in.	mm in.	mm in.	N lbf				N lbf	N lbf	N lbf	
303.886 11.9640	419.100 16.5000	161.925 6.3750	129.540 5.1000	2060000 464000	0.52	1.30	1.94	307000 69100	273000 61400	535000 120000	1.13
304.800 12.0000	419.100 16.5000	161.925 6.3750	129.540 5.1000	2060000 464000	0.52	1.30	1.94	307000 69100	273000 61400	535000 120000	1.13
355.600 14.0000	444.500 17.5000	136.525 5.3750	111.125 4.3750	1280000 287000	0.31	2.20	3.27	190000 42700	100000 22500	331000 74400	1.90

⁽¹⁾Based on 1×10^6 revolutions L_{10} life, for the ISO life-calculation method. $C_{1(2)}$ is the double-row radial value.

⁽²⁾Consult your Timken engineer for instructions on use or review the Timken Engineering Manual on timken.com/catalogs.

⁽³⁾Based on 90×10^6 revolutions L_{10} life, for The Timken Company life-calculation method. C_{90} and C_{a90} are radial and thrust values for a single-row. $C_{90(2)}$ is the double-row radial value.

Part Number		Dimensions				Bearing Weight
Inner	Outer	Shaft		Housing		
		Max Shaft Fillet Radius R ⁽⁴⁾	Backing Shoulder Dia. d _b	Max Housing Fillet Radius r ⁽⁴⁾	Backing Shoulder Dia. D _a	
		mm in.	mm in.	mm in.	mm in.	kg lbs.
NP446605	NP930308	6.4 0.25	336.0 13.23	1.5 0.06	406.9 16.02	64.32 141.79
NP633856	NP930308	6.4 0.25	336.0 13.23	1.5 0.06	406.9 16.02	63.76 140.57
L163149NW	L163110CD	3.5 0.14	374.0 14.72	1.5 0.06	430.0 16.93	44.96 99.12

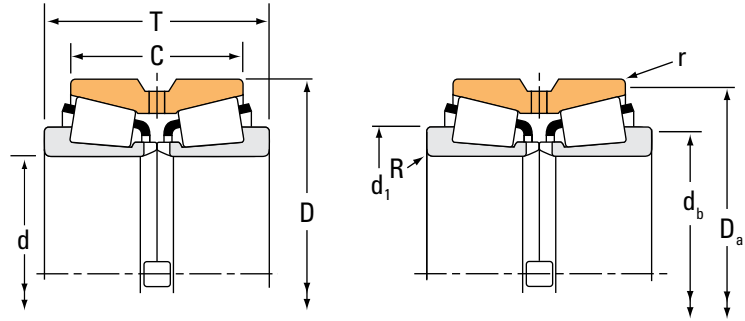
⁽⁴⁾These maximum fillet radii will be cleared by bearing corners.

NOTE: For desired fitting practice and resultant mounted setting range information, contact your Timken engineer.

TAPERED ROLLER BEARINGS

DOUBLE-ROW • TYPE TNASWE

TYPE TNASWE



Bearing Dimensions				Load Ratings							
Bore d	O.D. D	Width T	Double Outer Ring Width C	Dynamic ⁽¹⁾				Dynamic ⁽³⁾			
				C ₁₍₂₎	e	Y ₁	Y ₂	C ₉₀	C _{a90}	C ₉₀₍₂₎	K
mm in.	mm in.	mm in.	mm in.	N lbf				N lbf	N lbf	N lbf	
19.050 0.7500	47.000 1.8504	34.925 1.3750	25.212 0.9926	46500 10500	0.36	1.89	2.82	6930 1560	4230 952	12100 2710	1.64
30.000 1.1811	63.500 2.5000	50.752 1.9981	36.512 1.4375	88000 19800	0.35	1.93	2.87	13100 2940	7860 1770	22800 5130	1.67
30.005 1.1813	63.500 2.5000	50.800 2.0000	36.512 1.4375	88000 19800	0.35	1.93	2.87	13100 2940	7860 1770	22800 5130	1.67
38.100 1.5000	76.200 3.0000	58.738 2.3125	39.688 1.5625	132000 29600	0.39	1.72	2.56	19600 4400	13200 2960	34100 7670	1.49
44.450 1.7500	95.250 3.7500	71.440 2.8126	50.800 2.0000	221000 49700	0.28	2.37	3.53	32900 7400	16000 3600	57300 12900	2.05
50.800 2.0000	107.950 4.2500	74.615 2.9376	53.975 2.1250	236000 53100	0.34	2.01	3.00	35200 7900	20200 4540	61200 13800	1.74
70.000 2.7559	120.000 4.7244	74.615 2.9376	53.975 2.1250	250000 56100	0.38	1.75	2.61	37200 8360	24500 5500	64700 14600	1.52
82.550 3.2500	139.992 5.5115	92.075 3.6250	66.675 2.6250	360000 80900	0.40	1.67	2.49	53600 12100	37100 8330	93400 21000	1.45
88.900 3.5000	152.400 6.0000	92.075 3.6250	63.500 2.5000	376000 84600	0.44	1.53	2.27	56000 12600	42400 9530	97500 21900	1.32
99.975 3.9360	164.975 6.4951	88.900 3.5000	63.500 2.5000	394000 88600	0.50	1.36	2.02	58700 13200	50000 11200	102000 23000	1.18
107.950 4.2500	165.100 6.5000	88.900 3.5000	63.500 2.5000	394000 88600	0.50	1.36	2.02	58700 13200	50000 11200	102000 23000	1.18
109.975 4.3297	179.975 7.0856	101.600 4.0000	69.850 2.7500	443000 99600	0.52	1.31	1.95	65900 14800	58300 13100	115000 25800	1.13
127.000 5.0000	182.562 7.1875	93.660 3.6874	73.025 2.8750	466000 105000	0.31	2.21	3.29	69400 15600	36300 8160	121000 27200	1.91
142.875 5.6250	200.025 7.8750	93.665 3.6876	73.025 2.8750	499000 112000	0.34	2.01	2.99	74300 16700	42800 9610	129000 29100	1.74
152.400 6.0000	211.138 8.3125	92.075 3.6250	69.850 2.7500	508000 114000	0.36	1.89	2.82	75600 17000	46200 10400	132000 29600	1.64
165.100 6.5000	225.425 8.8750	95.250 3.7500	69.850 2.7500	528000 119000	0.38	1.76	2.62	78600 17700	51600 11600	137000 30800	1.52
177.800 7.0000	282.575 11.1250	107.950 4.2500	79.375 3.1250	886000 199000	0.42	1.62	2.42	132000 29700	93900 21100	230000 51700	1.41

⁽¹⁾Based on 1 x 10⁶ revolutions L₁₀ life, for the ISO life-calculation method. C₁₍₂₎ is the double-row radial value.

⁽²⁾Consult your Timken engineer for instructions on use or review the Timken Engineering Manual on timken.com/catalogs.

⁽³⁾Based on 90 x 10⁶ revolutions L₁₀ life, for The Timken Company life-calculation method. C₉₀ and C_{a90} are radial and thrust values for a single row. C₉₀₍₂₎ is the double-row radial value.

Part Number		Dimensions					Bearing Weight
Inner	Outer	Bearing	Shaft		Housing		
		Outside Dia. (rib) d ₁ ⁽⁴⁾	Max Shaft Fillet Radius R ⁽⁵⁾	Backing Shoulder Dia. d _b	Max Housing Fillet Radius r ⁽⁵⁾	Backing Shoulder Dia. D _a	
			mm in.	mm in.	mm in.	mm in.	kg lbs.
NA05076SW	05185D	32.362 1.2741	0.8 0.03	24.0 0.94	0.8 0.03	42.5 1.67	0.26 0.595
NA15118SW	15251D	45.763 1.8017	3.5 0.14	41.0 1.61	0.8 0.03	59.0 2.32	0.73 1.599
NA15117SW	15251D	45.763 1.8017	0.8 0.03	35.5 1.40	0.8 0.03	59.0 2.32	0.73 1.605
NA24776SW	24720D	58.25 2.2933	0.8 0.03	45.0 1.77	0.8 0.03	72.0 2.83	1.15 2.543
NA435SW	432D	65.019 2.5598	3.5 0.14	57.0 2.24	0.8 0.03	87.0 3.43	2.12 4.691
NA456SW	452D	79.098 3.1141	3.5 0.14	65.0 2.56	0.8 0.03	100.0 3.94	3.02 6.649
NA483SW	472D	92.812 3.654	3.5 0.14	83.0 3.27	0.8 0.03	114.0 4.49	3.11 6.877
NA580SW	572D	109.802 4.3229	3.5 0.14	98.0 3.86	0.8 0.03	133.0 5.24	4.87 10.758
NA596SW	592D	121.222 4.7725	3.5 0.14	104.0 4.09	0.8 0.03	144.0 5.67	5.97 13.148
NA56393SW	56649D	137.792 5.4249	3.5 0.14	117.0 4.61	0.8 0.03	159.0 6.26	7.22 15.899
NA56425SW	56650D	137.792 5.4249	3.5 0.14	123.0 4.84	0.8 0.03	159.0 6.26	6.31 13.928
NA64432SW	64708D	146.545 5.7695	3.5 0.14	128.0 5.04	0.8 0.03	173.0 6.81	9.25 20.385
NA48290SW	48220D	155.13 6.1075	3.5 0.14	141.0 5.55	0.8 0.03	176.0 6.93	7.63 16.839
NA48685SW	48620D	172.001 6.7717	3.5 0.14	158.0 6.22	0.8 0.03	193.0 7.60	8.43 18.579
NA48990SW	48920D	183.096 7.2085	3.5 0.14	168.0 6.61	0.8 0.03	204.0 8.03	9.26 20.399
NA46790SW	46720CD	197.104 7.76	3.5 0.14	181.0 7.13	0.8 0.03	218.0 8.58	10.44 23.006
NA87700SW	87112D	233.213 9.1816	3.5 0.14	200.0 7.87	1.5 0.06	267.0 10.50	22.95 50.585

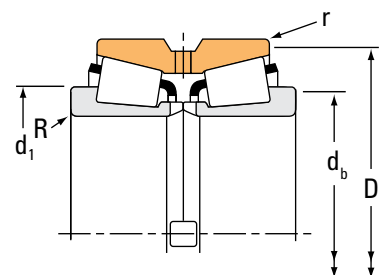
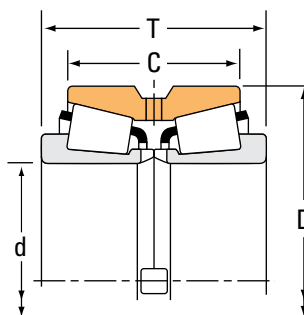
⁽⁴⁾Tolerance +0 +127 μm, +0 +0.005 in.

⁽⁵⁾These maximum fillet radii will be cleared by bearing corners.

TAPERED ROLLER BEARINGS

DOUBLE-ROW • TYPE TNASWE

TYPE TNASWE



Bearing Dimensions				Load Ratings							
Bore d	O.D. D	Width T	Double Outer Ring Width C	Dynamic ⁽¹⁾				Dynamic ⁽³⁾			
				C ₁₍₂₎	e	Factors ⁽²⁾ Y ₁	Y ₂	C ₉₀	C _{a90}	C ₉₀₍₂₎	Factors ⁽²⁾ K
mm in.	mm in.	mm in.	mm in.	N lbf				N lbf	N lbf	N lbf	
184.150 7.2500	242.888 9.5625	95.250 3.7500	69.850 2.7500	541000 122000	0.42	1.61	2.40	80600 18100	57800 13000	140000 31600	1.39
190.500 7.5000	266.700 10.5000	109.538 4.3125	84.138 3.3125	725000 163000	0.48	1.41	2.11	108000 24300	88200 19800	188000 42300	1.22
203.200 8.0000	276.225 10.8750	95.250 3.7500	73.025 2.8750	764000 172000	0.32	2.12	3.15	114000 25600	62100 14000	198000 44500	1.83
234.950 9.2500	311.150 12.2500	101.600 4.0000	73.025 2.8750	768000 173000	0.36	1.86	2.77	114000 25700	70900 15900	199000 44800	1.61
244.475 9.6250	349.148 13.7460	133.350 5.2500	101.600 4.0000	1150000 258000	0.35	1.91	2.85	171000 38500	103000 23300	298000 67000	1.65
253.975 9.9990	347.662 13.6875	101.600 4.0000	69.850 2.7500	1070000 240000	0.33	2.03	3.02	159000 35700	90500 20300	277000 62200	1.76
260.350 10.2500	400.050 15.7500	146.050 5.7500	107.950 4.2500	1440000 324000	0.39	1.71	2.55	215000 48200	145000 32600	374000 84000	1.48
266.700 10.5000	352.425 13.8750	107.950 4.2500	82.550 3.2500	985000 221000	0.32	2.12	3.15	147000 33000	80100 18000	255000 57400	1.83
304.800 12.0000	393.700 15.5000	107.950 4.2500	82.550 3.2500	1020000 229000	0.36	1.88	2.80	152000 34200	93500 21000	265000 59500	1.63

⁽¹⁾Based on 1 x 10⁶ revolutions L₁₀ life, for the ISO life-calculation method. C₁₍₂₎ is the double-row radial value.

⁽²⁾Consult your Timken engineer for instructions on use or review the Timken Engineering Manual on timken.com/catalogs.

⁽³⁾Based on 90 x 10⁶ revolutions L₁₀ life, for The Timken Company life-calculation method. C₉₀ and C_{a90} are radial and thrust values for a single row. C₉₀₍₂₎ is the double-row radial value.

Part Number		Dimensions					Bearing Weight
Inner	Outer	Bearing	Shaft		Housing		
		Outside Dia. (rib) d ₁ ⁽⁴⁾	Max Shaft Fillet Radius R ⁽⁵⁾	Backing Shoulder Dia. d _b	Max Housing Fillet Radius r ⁽⁵⁾	Backing Shoulder Dia. D _a	
			mm in.	mm in.	mm in.	mm in.	kg lbs.
LM637349NW	LM637310D	215.4 8.4803	3.5 0.14	199.0 7.83	0.8 0.03	236.0 9.29	10.98 24.210
NA67885SW	67820CD	232.268 9.1444	3.5 0.14	209.0 8.23	0.8 0.03	259.0 10.20	17.74 39.083
LM241149NW	LM241110D	240.434 9.4659	3.5 0.14	220.0 8.66	0.8 0.03	267.0 10.51	15.02 33.114
LM446349NW	LM446310D	274.716 10.8156	3.5 0.14	252.0 9.92	0.8 0.03	301.0 11.85	18.63 41.085
NA127096SW	127136CD	290.452 11.4351	6.4 0.25	269.0 10.59	1.5 0.06	329.0 12.95	34.95 77.015
LM249747NW	LM249710CD	294.284 11.586	3.5 0.14	272.0 10.71	1.5 0.06	333.0 13.11	23.62 52.075
NA221027SW	221576CD	323.131 12.7217	6.4 0.25	290.0 11.42	1.5 0.06	371.5 14.63	58.77 129.541
LM251649NW	LM251610D	309.865 12.1994	6.4 0.25	291.0 11.46	1.5 0.06	340.0 13.39	26.60 58.626
L357049NW	L357010CD	350.446 13.7971	6.4 0.25	329.0 12.95	1.5 0.06	380.0 14.96	30.19 66.565

⁽⁴⁾Tolerance +0 +127 μm, +0 +0.005 in.

⁽⁵⁾These maximum fillet radii will be cleared by bearing corners.

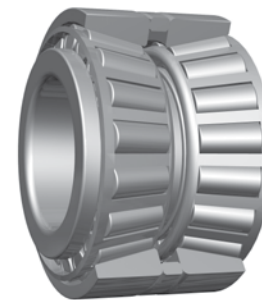
SPACER ASSEMBLIES

- Any two matching single-row bearings (type TS) can be supplied as a double-row, pre-set, ready-to-fit assembly by the addition of spacers, machined to pre-determined dimensions and tolerances.

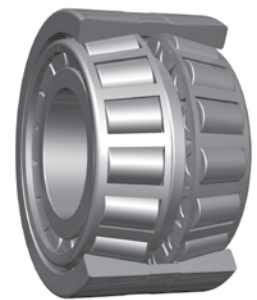
- There are two basic mounting arrangements for single-row spacer assemblies:

- Type 2TS-IM (indirect mounting)**
These consist of two single-row bearings with an inner-ring and outer-ring spacer. In some applications, the outer-ring spacer is replaced by a shoulder in the bearing housing.
 - Type 2TS-DM (direct mounting)**
These consist of two single-row bearings, with cone (inner-ring) backfaces abutting and an outer-ring spacer. They are generally used at fixed (locating) positions on rotating shaft applications.

- Along with the standard 2TS types, there are two specialty double-row assemblies available:



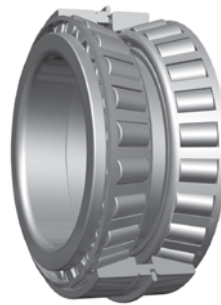
2TS-IM



2TS-DM



2S



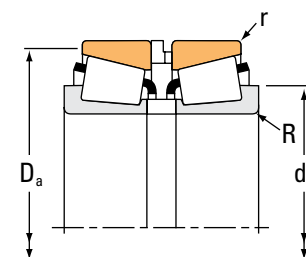
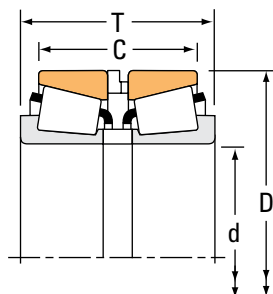
SR

- Type 2S - Two single-row assembly**
Supplied complete with inner-ring and outer-ring spacers to give a pre-determined bearing setting when assembled. The setting range can be specified to suit the application. Type 2S has an inner-ring spacer and a snap-ring, which also serves as the cup spacer, to give axial location in a through-bored housing.
 - Type SR - SET-RIGHT assembly**
Type SR is made to a standard setting range, based on Timken's SET-RIGHT automated setting technique, suitable for most industrial applications. It is equipped with two spacers and an optional snap-ring that may be used for axial location.

TAPERED ROLLER BEARINGS

DOUBLE-ROW • TYPE 2TS-IM

TYPE 2TS-IM



Bearing Dimensions				Load Ratings							
Bore d	O.D. D	Width ⁽¹⁾ T	Width C	Dynamic ⁽²⁾				Dynamic ⁽⁴⁾			
				C ₁₍₂₎	e	Factors ⁽³⁾ Y ₁	Y ₂	C ₉₀	C _{a90}	C ₉₀₍₂₎	Factors ⁽³⁾ K
mm in.	mm in.	mm in.	mm in.	N lbf				N lbf	N lbf	N lbf	
21.987 0.8656	45.975 1.8100	34.950 1.3760	28.092 1.1060	67200 15100	0.31	2.21	3.28	10000 2250	5250 1180	17400 3920	1.91
28.575 1.1250	68.262 2.6875	49.425 1.9459	39.901 1.5709	133000 29900	0.55	1.24	1.84	19800 4450	18500 4160	34400 7740	1.07
30.000 1.1811	72.000 2.8346	78.740 3.1000	66.040 2.6000	180000 40400	0.55	1.24	1.84	26700 6010	25000 5620	46600 10500	1.07
34.925 1.3750	76.073 2.9950	56.337 2.2180	44.614 1.7565	134000 30100	0.55	1.24	1.84	19900 4480	18600 4180	34700 7790	1.07
34.987 1.3775	59.975 2.3612	35.712 1.4060	27.838 1.0960	79200 17800	0.42	1.62	2.42	11800 2650	8400 1890	20500 4620	1.40
35.000 1.3780	62.000 2.4409	40.575 1.5974	32.575 1.2825	98400 22100	0.45	1.49	2.21	14600 3290	11400 2560	25500 5730	1.29
38.000 1.4961	63.000 2.4803	37.810 1.4886	30.810 1.2130	88800 20000	0.42	1.62	2.42	13200 2970	9410 2120	23000 5170	1.40
38.100 1.5000	79.375 3.1250	63.515 2.5006	52.400 2.0630	182000 41000	0.37	1.85	2.75	27100 6100	17000 3820	47200 10600	1.60
38.100 1.5000	85.725 3.3750	67.183 2.6450	54.483 2.1450	216000 48600	0.40	1.68	2.50	32200 7240	22200 4980	56100 12600	1.45
38.100 1.5000	85.725 3.3750	101.600 4.0000	88.900 3.5000	216000 48600	0.40	1.68	2.50	32200 7240	22200 4980	56100 12600	1.45
39.688 1.5625	80.035 3.1510	87.315 3.4376	76.200 3.0000	200000 45000	0.27	2.47	3.68	29800 6700	13900 3130	51900 11700	2.14
40.000 1.5748	88.500 3.4843	63.602 2.5040	54.077 2.1290	201000 45300	0.26	2.56	3.81	30000 6740	13500 3040	52200 11700	2.22
40.483 1.5938	82.550 3.2500	63.058 2.4826	50.358 1.9826	179000 40200	0.55	1.24	1.84	26600 5980	24900 5590	46400 10400	1.07
41.275 1.6250	73.431 2.8910	42.672 1.6800	33.020 1.3000	130000 29300	0.40	1.69	2.52	19400 4360	13300 2980	33800 7590	1.46
41.275 1.6250	82.550 3.2500	61.087 2.4050	48.387 1.9050	160000 35900	0.55	1.24	1.84	23800 5340	22200 4990	41400 9300	1.07
41.275 1.6250	85.725 3.3750	66.675 2.6250	53.975 2.1250	216000 48600	0.40	1.68	2.50	32200 7240	22200 4980	56100 12600	1.45
42.070 1.6563	90.488 3.5625	87.376 3.4400	74.676 2.9400	346000 77700	0.28	2.37	3.53	51500 11600	25100 5640	89700 20200	2.05

⁽¹⁾Overall width can vary depending on spacer selection. Contact your Timken engineer for more information.

⁽²⁾Based on 1×10^6 revolutions L_{10} life, for the ISO life-calculation method. $C_{1(2)}$ is the double-row radial value.

⁽³⁾Consult your Timken engineer for instructions on use or review the Timken Engineering Manual on timken.com/catalogs.

⁽⁴⁾Based on 90×10^6 revolutions L_{10} life, for The Timken Company life-calculation method. C_{90} and C_{a90} are radial and thrust values for single-row. $C_{90(2)}$ is the double-row radial value.

Part Number				Dimensions				Bearing Weight
Inner	Outer	Inner Spacer ⁽⁵⁾	Outer Spacer ⁽⁵⁾	Shaft		Housing		
				Max. Shaft Fillet Radius R ⁽⁶⁾	Backing Shoulder Dia. d _b	Max. Housing Fillet Radius r ⁽⁶⁾	Backing Shoulder Dia. D _a	
				mm in.	mm in.	mm in.	mm in.	kg lbs.
LM12749	LM12711	K523966R		1.3 0.05	27.5 1.08	0.4 0.02	42.5 1.67	0.25 0.57
M88040A	M88010	M88040XA		0.3 0.01	40.0 1.57	0.4 0.02	65.0 2.56	0.84 1.89
JHM88540	JHM88513	K160075		1.3 0.05	44.5 1.75	0.3 0.01	69.0 2.72	1.27 2.84
HM88649	HM88610	HM88649XB	XC2360-SA	2.3 0.09	48.5 1.91	0.4 0.02	69.0 2.72	1.04 2.31
L68149	L68111	K154145R	L68111EC	3.5 0.14	45.5 1.79	0.4 0.02	56.0 2.20	0.38 0.83
X32007X	Y32007X	JX3505A	JYH6205R	1.0 0.04	43.0 1.69	0.1 0.01	59.5 2.34	0.49 1.09
JL69349	JL69310	K158596R	K158598R	0.4 0.02	46.5 1.83	0.3 0.01	60.0 2.36	0.44 0.96
3490	3420	X1S-28150		3.5 0.14	52.0 2.05	0.8 0.03	74.0 2.91	1.32 2.93
3876	3820	X1S-25572		3.5 0.14	55.0 2.17	0.8 0.03	81.0 3.19	1.71 3.78
3875	3821	X1S-3875	Y1S-3821	0.8 0.03	49.5 1.95	0.8 0.03	81.0 3.19	2.33 5.11
3382	3339	X1S-3382		3.5 0.14	52.0 2.05	0.8 0.03	74.8 2.94	1.40 3.10
420	414	K143256R	Y1H414	3.5 0.14	52.0 2.05	0.8 0.03	80.0 3.15	1.75 3.84
HM801349	HM801310	HM801349XA		3.5 0.14	58.0 2.28	0.5 0.02	78.0 3.07	1.46 3.25
LM501349	LM501310	K143254	LM501310ES	3.5 0.14	54.0 2.13	0.5 0.02	70.0 2.76	0.73 1.59
M802048	M802011	K165354	K165355	3.5 0.14	57.0 2.24	0.5 0.02	79.0 3.11	1.35 3.00
3880	3820	X1S-3880	Y7S-3820	0.8 0.03	52.0 2.05	0.8 0.03	81.0 3.19	1.71 3.76
4395	4335	X1S-4395	Y1S-4335	3.5 0.14	60.0 2.36	0.8 0.03	85.0 3.35	2.60 5.74

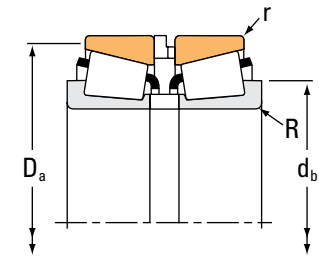
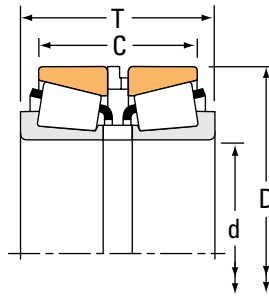
⁽⁵⁾Contact your Timken engineer for information on spacer configurations.

⁽⁶⁾These maximum fillet radii will be cleared by the bearing corners.

TAPERED ROLLER BEARINGS

DOUBLE-ROW • TYPE 2TS-IM

TYPE 2TS-IM



Bearing Dimensions				Load Ratings							
Bore d	O.D. D	Width ⁽¹⁾ T	Width C	Dynamic ⁽²⁾		Factors ⁽³⁾		Dynamic ⁽⁴⁾			Factors ⁽³⁾
				C ₁₍₂₎	e	Y ₁	Y ₂	C ₉₀	C _{a90}	C ₉₀₍₂₎	K
mm in.	mm in.	mm in.	mm in.	N lbf				N lbf	N lbf	N lbf	
42.875 1.6880	80.167 3.1562	55.560 2.1874	46.035 1.8124	159000 35700	0.32	2.12	3.15	23600 5310	12900 2900	41100 9240	1.83
44.450 1.7500	95.250 3.7500	74.615 2.9376	57.150 2.2500	237000 53400	0.74	0.91	1.36	35400 7950	44800 10100	61600 13800	0.79
44.987 1.7712	104.986 4.1333	69.342 2.7300	51.054 2.0100	234000 52700	0.78	0.86	1.29	34900 7850	46700 10500	60800 13700	0.75
45.242 1.7812	77.788 3.0625	43.647 1.7184	34.122 1.3434	133000 29900	0.43	1.58	2.35	19800 4450	14500 3250	34400 7740	1.37
45.242 1.7812	77.788 3.0625	44.247 1.7420	34.722 1.3670	133000 29900	0.43	1.58	2.35	19800 4450	14500 3250	34400 7740	1.37
45.242 1.7812	77.788 3.0625	46.822 1.8434	37.297 1.4684	133000 29900	0.43	1.58	2.35	19800 4450	14500 3250	34400 7740	1.37
49.212 1.9375	114.300 4.5000	95.250 3.7500	76.200 3.0000	389000 87500	0.43	1.57	2.34	58000 13000	42700 9600	101000 22700	1.36
50.000 1.9685	82.000 3.2283	48.428 1.9066	39.426 1.5522	168000 37700	0.31	2.21	3.29	25000 5610	13000 2930	43500 9770	1.91
50.000 1.9685	82.000 3.2283	66.000 2.5984	57.000 2.2441	168000 37700	0.31	2.21	3.29	25000 5610	13000 2930	43500 9770	1.91
50.000 1.9685	90.000 3.5433	50.000 1.9685	40.500 1.5945	150000 33600	0.42	1.61	2.39	22300 5010	16000 3600	38800 8720	1.39
50.000 1.9685	90.000 3.5433	83.287 3.2790	73.287 2.8853	255000 57400	0.33	2.05	3.06	38000 8540	21400 4810	66200 14900	1.78
50.000 1.9685	105.000 4.1339	79.543 3.1316	63.540 2.5016	354000 79600	0.49	1.38	2.06	52700 11900	44000 9890	91800 20600	1.20
50.800 2.0000	82.550 3.2500	51.766 2.0380	41.606 1.6380	168000 37700	0.31	2.21	3.29	25000 5610	13000 2930	43500 9770	1.91
50.800 2.0000	85.000 3.3465	40.640 1.6000	40.640 1.6000	95200 21400	0.41	1.66	2.48	14200 3190	9840 2210	24700 5550	1.44
50.800 2.0000	85.000 3.3465	79.375 3.1250	71.440 2.8126	95200 21400	0.41	1.66	2.48	14200 3190	9840 2210	24700 5550	1.44
50.800 2.0000	92.075 3.6250	55.560 2.1874	46.035 1.8124	172000 38700	0.38	1.79	2.66	25700 5770	16600 3720	44700 10000	1.55
50.800 2.0000	93.264 3.6718	64.287 2.5310	51.587 2.0310	213000 47800	0.34	1.99	2.97	31700 7120	18300 4120	55100 12400	1.73

⁽¹⁾Overall width can vary depending on spacer selection. Contact your Timken engineer for more information.

⁽²⁾Based on 1×10^6 revolutions L_{10} life, for the ISO life-calculation method. $C_{1(2)}$ is the double-row radial value.

⁽³⁾Consult your Timken engineer for instructions on use or review the Timken Engineering Manual on timken.com/catalogs.

⁽⁴⁾Based on 90×10^6 revolutions L_{10} life, for The Timken Company life-calculation method. C_{90} and C_{a90} are radial and thrust values for single-row.

$C_{90(2)}$ is the double-row radial value.

Part Number				Dimensions				Bearing Weight
Inner	Outer	Inner Spacer ⁽⁵⁾	Outer Spacer ⁽⁵⁾	Shaft		Housing		
				Max. Shaft Fillet Radius R ⁽⁶⁾	Backing Shoulder Dia. d _b	Max. Housing Fillet Radius r ⁽⁶⁾	Backing Shoulder Dia. D _a	
				mm in.	mm in.	mm in.	mm in.	kg lbs.
26886	26820	X2S-22168	Y3S-26820	1.5 0.06	51.0 2.01	0.8 0.03	74.0 2.91	1.13 2.50
HM903249	HM903210	HM903249XC		3.5 0.14	65.0 2.56	0.6 0.03	91.0 3.58	2.08 4.60
HM905843	HM905810	HM905843XA		2.5 0.10	68.0 2.68	0.8 0.03	100.0 3.94	2.81 6.22
LM603049	LM603011	LM603049XB		3.5 0.14	58.0 2.28	0.4 0.02	74.0 2.91	0.79 1.74
LM603049	LM603011	K109152R		3.5 0.14	58.0 2.28	0.4 0.02	74.0 2.91	0.75 1.65
LM603049	LM603011	LM603049XF	LM603011EX	3.5 0.14	58.0 2.28	0.4 0.02	74.0 2.91	0.80 1.77
65390	65320	X1S-65390	Y1S-65320	3.5 0.14	70.0 2.76	0.8 0.03	107.0 4.21	4.55 10.01
JLM104948	JLM104910	LM104948XB	LM104910ES	3.0 0.12	61.0 2.40	0.4 0.02	78.0 3.07	0.98 2.16
JLM104948	JLM104910	X4S-3780		3.0 0.12	61.0 2.40	0.4 0.02	78.0 3.07	0.96 2.13
X30210UM	Y30210UM	K162853	K162854	1.5 0.06	60.0 2.36	0.8 0.03	86.0 3.39	1.24 2.70
JM205149	JM205110	JX5027A	K154155	3.0 0.12	63.0 2.48	0.5 0.02	85.0 3.35	1.93 4.25
JHM807045	JHM807012	HM807045XA	HM807012ES	3.0 0.12	69.0 2.72	0.8 0.03	100.0 3.94	3.13 6.87
LM104949E	LM104911		LM104911EA	3.5 0.14	62.0 2.44	0.6 0.03	78.0 3.07	0.97 2.11
18790	18720	X4S-18790		3.5 0.14	62.0 2.44	0.8 0.03	80.0 3.15	0.75 1.66
18790	18720	X7S-18790	Y5S-18720	3.5 0.14	62.0 2.44	0.8 0.03	80.0 3.15	0.91 2.02
28580	28523	X1S-28580		3.5 0.14	63.0 2.48	0.8 0.03	87.0 3.43	1.56 3.41
3780	3730	K426900R		3.5 0.14	64.0 2.52	0.8 0.03	88.0 3.46	1.74 3.82

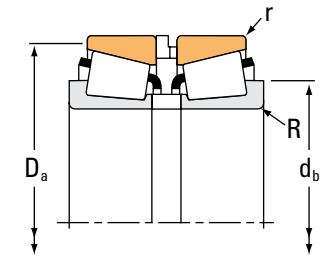
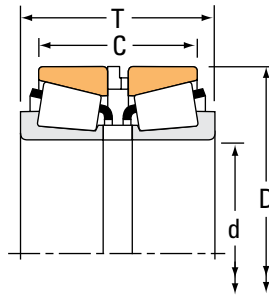
⁽⁵⁾Contact your Timken engineer for information on spacer configurations.

⁽⁶⁾These maximum fillet radii will be cleared by the bearing corners.

TAPERED ROLLER BEARINGS

DOUBLE-ROW • TYPE 2TS-IM

TYPE 2TS-IM



Bearing Dimensions				Load Ratings							
Bore d	O.D. D	Width ⁽¹⁾ T	Width C	Dynamic ⁽²⁾				Dynamic ⁽⁴⁾			
				C ₁₍₂₎	e	Factors ⁽³⁾ Y ₁	Y ₂	C ₉₀	C _{a90}	C ₉₀₍₂₎	Factors ⁽³⁾ K
mm in.	mm in.	mm in.	mm in.	N lbf				N lbf	N lbf	N lbf	
50.800 2.0000	101.600 4.0000	78.580 3.0937	62.705 2.4687	287000 64400	0.29	2.37	3.52	42700 9600	20800 4690	74300 16700	2.05
50.800 2.0000	104.775 4.1250	79.375 3.1250	63.500 2.5000	354000 79600	0.49	1.38	2.06	52700 11900	44000 9890	91800 20600	1.20
50.800 2.0000	127.000 5.0000	95.250 3.7500	76.200 3.0000	424000 95300	0.49	1.38	2.06	63100 14200	52700 11800	110000 24700	1.20
55.000 2.1654	90.000 3.5433	51.504 2.0277	42.504 1.6733	190000 42600	0.40	1.68	2.50	28200 6340	19400 4370	49100 11000	1.45
55.000 2.1654	95.000 3.7402	63.418 2.4968	52.418 2.0637	227000 51100	0.33	2.02	3.00	33800 7610	19400 4360	58900 13200	1.74
55.000 2.1654	95.000 3.7402	66.152 2.6044	55.154 2.1714	227000 51100	0.33	2.02	3.00	33800 7610	19400 4360	58900 13200	1.74
55.000 2.1654	95.000 3.7402	76.200 3.0000	65.200 2.5670	227000 51100	0.33	2.02	3.00	33800 7610	19400 4360	58900 13200	1.74
55.000 2.1654	100.000 3.9370	64.600 2.5433	53.100 2.0905	210000 47300	0.40	1.67	2.48	31300 7040	21700 4880	54500 12300	1.44
57.150 2.2500	96.838 3.8125	49.174 1.9360	38.923 1.5324	188000 42200	0.35	1.91	2.84	28000 6280	16900 3810	48700 10900	1.65
57.150 2.2500	96.838 3.8125	76.037 2.9936	65.786 2.5900	188000 42200	0.35	1.91	2.84	28000 6280	16900 3810	48700 10900	1.65
57.150 2.2500	104.775 4.1250	63.094 2.4840	51.979 2.0464	280000 62900	0.34	2.01	3.00	41700 9370	23900 5380	72600 16300	1.74
57.150 2.2500	104.775 4.1250	163.512 6.4375	150.812 5.9375	267000 60000	0.33	2.03	3.02	39700 8930	22600 5090	69200 15600	1.76
57.150 2.2500	112.712 4.4375	69.850 2.2500	57.150 2.2500	242000 54300	0.40	1.68	2.50	36000 8090	24800 5570	62700 14100	1.45
57.150 2.2500	112.712 4.4375	67.602 2.6615	54.902 2.1615	291000 65300	0.34	1.99	2.96	43300 9730	25100 5650	75400 16900	1.72
60.000 2.3622	95.000 3.7402	53.500 2.1060	43.500 1.7122	170000 38200	0.40	1.68	2.50	25300 5690	17400 3910	44000 9900	1.45
64.960 2.5575	149.225 5.8750	285.750 11.2500	266.700 10.5000	716000 161000	0.36	1.86	2.78	107000 24000	66000 14800	186000 41700	1.61
65.000 2.5591	105.000 4.1339	53.515 2.1070	42.515 1.6738	223000 50200	0.45	1.49	2.21	33200 7470	25800 5810	57900 13000	1.29

⁽¹⁾Overall width can vary depending on spacer selection. Contact your Timken engineer for more information.

⁽²⁾Based on 1×10^6 revolutions L_{10} life, for the ISO life-calculation method. $C_{1(2)}$ is the double-row radial value.

⁽³⁾Consult your Timken engineer for instructions on use or review the Timken Engineering Manual on timken.com/catalogs.

⁽⁴⁾Based on 90×10^6 revolutions L_{10} life, for The Timken Company life-calculation method. C_{90} and C_{a90} are radial and thrust values for single-row. $C_{90(2)}$ is the double-row radial value.

Part Number				Dimensions				Bearing Weight
Inner	Outer	Inner Spacer ⁽⁵⁾	Outer Spacer ⁽⁵⁾	Shaft		Housing		
				Max. Shaft Fillet Radius R ⁽⁶⁾	Backing Shoulder Dia. d _b	Max. Housing Fillet Radius r ⁽⁶⁾	Backing Shoulder Dia. D _a	
				mm in.	mm in.	mm in.	mm in.	kg lbs.
529	522	X1S-529	Y1S-522	0.8 0.03	61.0 2.40	0.8 0.03	95.0 3.74	2.61 5.76
HM807046	HM807010	HM807046XA	HM807010EC	3.5 0.14	70.0 2.76	0.8 0.03	100.0 3.94	3.08 6.80
65200	65500	X1S-65200	Y1S-65500	3.5 0.14	75.0 2.95	0.8 0.03	119.0 4.69	6.06 13.37
JLM506849	JLM506810	X4S-385	LM506810ES	1.5 0.06	63.0 2.48	0.5 0.02	86.0 3.39	1.15 2.57
JM207049	JM207010	X4S-385	M207010ES	1.5 0.06	64.0 2.52	0.5 0.02	91.0 3.58	1.75 3.87
JM207049	JM207010	JX5508A	JYH9508P	1.5 0.06	64.0 2.52	0.5 0.02	91.0 3.58	1.81 4.00
JM207049	JM207010	M207049XA	M207010EB	1.5 0.06	64.0 2.52	0.5 0.02	91.0 3.58	2.02 4.46
X32211	Y32211	JX5515A	JYH10011-Q	2.0 0.08	65.0 2.56	0.8 0.03	95.0 3.74	1.87 4.12
387A	382A	X1S-387	Y4S-382A	3.5 0.14	70.0 2.76	0.4 0.02	92.0 3.62	1.29 2.84
387A	382A	X3S-387A		3.5 0.14	70.0 2.76	0.4 0.02	92.0 3.62	1.39 3.06
462	453X	X5S-462		2.3 0.09	67.0 2.64	0.8 0.03	98.0 3.86	2.13 4.68
45289	45221	X1S-45289	Y1S-45221	0.8 0.03	65.0 2.56	0.8 0.03	99.0 3.90	4.60 10.15
3979	3925	X4S-3979	Y1S-3920	3.5 0.14	72.0 2.83	0.5 0.02	106.0 4.17	3.00 6.62
39580	39521	X1S-39580		3.5 0.14	74.0 2.91	0.8 0.03	107.0 4.21	2.85 6.31
JLM508748	JLM508710	LM508748XA	LM508710ES	5.0 0.20	75.0 2.95	0.5 0.02	91.0 3.58	1.27 2.78
6464	6420	X1S-6464	Y4S-6420	3.5 0.14	87.0 3.43	0.8 0.03	140.0 5.51	17.66 38.94
JLM710949C	JLM710910	LM710949XA	LM710910ES	3.0 0.12	78.0 3.07	0.4 0.02	100.5 3.96	1.62 3.53

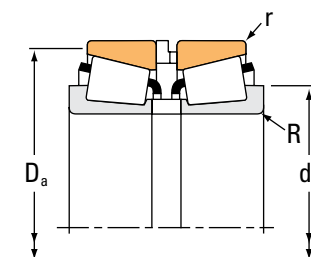
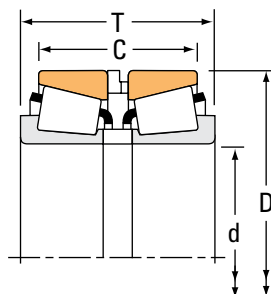
⁽⁵⁾Contact your Timken engineer for information on spacer configurations.

⁽⁶⁾These maximum fillet radii will be cleared by the bearing corners.

TAPERED ROLLER BEARINGS

DOUBLE-ROW • TYPE 2TS-IM

TYPE 2TS-IM



Bearing Dimensions				Load Ratings							
Bore d	O.D. D	Width ⁽¹⁾ T	Width C	Dynamic ⁽²⁾				Dynamic ⁽⁴⁾			
				C ₁₍₂₎	e	Factors ⁽³⁾ Y ₁	Y ₂	C ₉₀	C _{a90}	C ₉₀₍₂₎	Factors ⁽³⁾ K
mm in.	mm in.	mm in.	mm in.	N lbf				N lbf	N lbf	N lbf	
65.000 2.5591	105.000 4.1339	72.365 2.8490	61.365 2.4160	223000 50200	0.45	1.49	2.21	33200 7470	25800 5810	57900 13000	1.29
65.000 2.5591	110.000 4.3307	61.491 2.4209	50.488 1.9877	291000 65400	0.40	1.68	2.50	43300 9740	29800 6700	75400 17000	1.45
65.087 2.5625	136.525 5.3750	98.425 3.8750	79.375 3.1250	556000 125000	0.47	1.43	2.12	82700 18600	67000 15100	144000 32400	1.24
65.087 2.5625	136.525 5.3750	193.675 7.6250	174.625 6.8750	556000 125000	0.47	1.43	2.12	82700 18600	67000 15100	144000 32400	1.24
66.675 2.6250	112.712 4.4375	67.945 2.6750	55.245 2.1750	291000 65300	0.34	1.99	2.96	43300 9730	25100 5650	75400 16900	1.72
66.675 2.6250	112.712 4.4375	69.850 2.7500	57.150 2.2500	242000 54300	0.40	1.68	2.50	36000 8090	24800 5570	62700 14100	1.45
66.675 2.6250	122.238 4.8125	102.000 4.0157	85.235 3.3557	465000 104000	0.34	2.00	2.98	69200 15600	40000 8990	121000 27100	1.73
66.675 2.6250	122.238 4.8125	106.147 4.1790	89.383 3.5190	465000 104000	0.34	2.00	2.98	69200 15600	40000 8990	121000 27100	1.73
66.675 2.6250	136.525 5.3750	98.425 3.8750	79.375 3.1250	556000 125000	0.47	1.43	2.12	82700 18600	67000 15100	144000 32400	1.24
66.675 2.6250	177.800 7.0000	127.000 5.0000	87.315 3.4376	785000 176000	0.80	0.85	1.26	117000 26300	160000 35900	203000 45700	0.73
68.262 2.6875	110.000 4.3307	52.253 2.0572	45.903 1.8072	172000 38700	0.40	1.68	2.50	25600 5760	17600 3970	44600 10000	1.45
68.262 2.6875	110.000 4.3307	79.045 3.1120	72.695 2.8620	172000 38700	0.40	1.68	2.50	25600 5760	17600 3970	44600 10000	1.45
68.262 2.6875	152.400 6.0000	105.250 4.1437	73.500 2.8937	589000 132000	0.66	1.03	1.53	87700 19700	98500 22100	153000 34300	0.89
69.850 2.7500	127.000 5.0000	95.250 3.7500	76.200 3.0000	399000 89700	0.50	1.34	2.00	59400 13400	51100 11500	103000 23300	1.16
69.850 2.7500	146.050 5.7500	88.900 3.5000	57.150 2.2500	474000 107000	0.78	0.86	1.28	70700 15900	94700 21300	123000 27700	0.75
69.850 2.7500	146.050 5.7500	90.488 3.5625	58.738 2.3125	474000 107000	0.78	0.86	1.28	70700 15900	94700 21300	123000 27700	0.75
69.850 2.7500	146.050 5.7500	91.516 3.6030	59.766 2.3530	474000 107000	0.78	0.86	1.28	70700 15900	94700 21300	123000 27700	0.75

⁽¹⁾Overall width can vary depending on spacer selection. Contact your Timken engineer for more information.

⁽²⁾Based on 1×10^6 revolutions L_{10} life, for the ISO life-calculation method. $C_{1(2)}$ is the double-row radial value.

⁽³⁾Consult your Timken engineer for instructions on use or review the Timken Engineering Manual on timken.com/catalogs.

⁽⁴⁾Based on 90×10^6 revolutions L_{10} life, for The Timken Company life-calculation method. C_{90} and C_{a90} are radial and thrust values for single-row. $C_{90(2)}$ is the double-row radial value.

Part Number				Dimensions				Bearing Weight
Inner	Outer	Inner Spacer ⁽⁵⁾	Outer Spacer ⁽⁵⁾	Shaft		Housing		
				Max. Shaft Fillet Radius	Backing Shoulder Dia.	Max. Housing Fillet Radius	Backing Shoulder Dia.	
				R ⁽⁶⁾	d _b	r ⁽⁶⁾	D _a	
				mm in.	mm in.	mm in.	mm in.	kg lbs.
JLM710949C	JLM710910	JX6526A	JYH10524-QH	3.0 0.12	78.0 3.07	0.4 0.02	100.5 3.96	1.99 4.36
JM511946	JM511910	M511946XA	M511910ES	3.0 0.12	78.0 3.07	0.8 0.03	105.0 4.13	2.24 4.93
H715340	H715311	H715340XB	H715311EB	3.5 0.14	89.0 3.50	0.6 0.03	132.0 5.20	7.05 15.54
H715340	H715311	H715340XA	H715311EA	3.5 0.14	89.0 3.50	0.6 0.03	132.0 5.20	11.16 24.60
39590	39520	X1S-39590	Y5S-39520	3.5 0.14	82.0 3.23	0.8 0.03	107.0 4.21	2.48 5.47
3984	3920	X1S-3984	Y1S-3920	3.5 0.14	80.0 3.15	0.5 0.02	106.0 4.17	2.51 5.56
HM212049	HM212011	K167207	K167208	3.5 0.14	82.0 3.23	0.8 0.03	116.0 4.57	4.60 10.11
HM212049	HM212011	HM212049XS	HM212011EB	3.5 0.14	82.0 3.23	0.8 0.03	116.0 4.57	4.71 10.36
H715341	H715311	H715341XA	H715311EB	3.5 0.14	91.0 3.58	0.6 0.03	132.0 5.20	6.94 15.30
HH914449	HH914412	HH914449XA	HH914412EB	3.5 0.14	106.0 4.17	1.5 0.06	165.0 6.50	14.31 31.51
399A	394A	X1S-399A		2.3 0.09	78.0 3.07	0.4 0.02	105.0 4.13	1.55 3.41
399A	394A	X7S-399A	Y7S-394A	2.3 0.09	78.0 3.07	0.4 0.02	105.0 4.13	2.58 5.69
9185	9121	X1S-9185	Y6S-9121	3.5 0.14	94.0 3.70	0.8 0.03	145.0 5.71	8.02 17.65
HM813846	HM813811	HM813846XA	HM813811EB	3.5 0.14	89.0 3.50	0.8 0.03	121.0 4.76	4.52 9.95
H913849	H913810	H913849XE	H913810ES	3.5 0.14	95.0 3.74	0.8 0.03	138.0 5.43	6.10 13.47
H913849	H913810	H913849XA	K85372	3.5 0.14	95.0 3.74	0.8 0.03	138.0 5.43	6.09 13.45
H913849	H913810	H913849XC	H913810EE	3.5 0.14	95.0 3.74	0.8 0.03	138.0 5.43	6.15 13.58

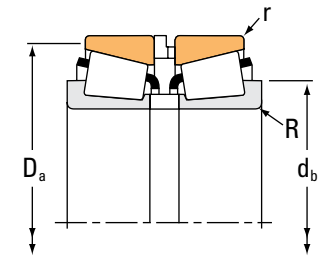
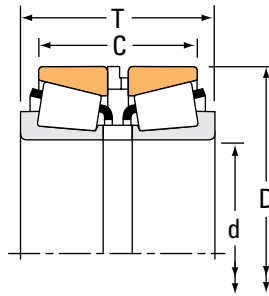
⁽⁵⁾Contact your Timken engineer for information on spacer configurations.

⁽⁶⁾These maximum fillet radii will be cleared by the bearing corners.

TAPERED ROLLER BEARINGS

DOUBLE-ROW • TYPE 2TS-IM

TYPE 2TS-IM



Bearing Dimensions				Load Ratings							
Bore d	O.D. D	Width ⁽¹⁾ T	Width C	Dynamic ⁽²⁾				Dynamic ⁽⁴⁾			
				C ₁₍₂₎	e	Factors ⁽³⁾ Y ₁	Y ₂	C ₉₀	C _{a90}	C ₉₀₍₂₎	Factors ⁽³⁾ K
mm in.	mm in.	mm in.	mm in.	N lbf				N lbf	N lbf	N lbf	
70.00 2.7559	110.00 4.3307	56.525 2.2254	44.525 1.7530	232000 52100	0.43	1.55	2.31	34500 7760	25700 5780	60100 13500	1.34
70.00 2.7559	115.00 4.5276	63.505 2.5002	51.507 2.0278	310000 69600	0.43	1.57	2.34	46100 10400	33900 7630	80300 18000	1.36
73.025 2.8750	112.712 4.4375	58.687 2.3105	45.987 1.8105	192000 43300	0.49	1.38	2.06	28600 6440	23900 5370	49900 11200	1.20
73.025 2.8750	117.475 4.6250	95.250 3.7500	82.550 3.2500	241000 54200	0.44	1.55	2.31	35900 8060	26800 6020	62400 14000	1.34
75.000 2.9528	115.000 4.5276	55.270 2.1760	43.270 1.7035	244000 54900	0.46	1.47	2.19	36400 8180	28600 6420	63400 14200	1.27
75.000 2.9528	115.000 4.5276	55.504 2.1852	43.504 1.7126	244000 54900	0.46	1.47	2.19	36400 8180	28600 6420	63400 14200	1.27
75.000 2.9528	115.000 4.5276	75.000 2.9528	63.000 2.4802	244000 54900	0.46	1.47	2.19	36400 8180	28600 6420	63400 14200	1.27
76.200 3.0000	161.925 6.3750	107.950 4.2500	73.025 2.8750	614000 138000	0.71	0.95	1.42	91400 20600	111000 24900	159000 35800	0.82
76.200 3.0000	161.925 6.3750	115.888 4.5625	93.662 3.6875	765000 172000	0.40	1.69	2.51	114000 25600	78100 17600	198000 44600	1.46
76.200 3.0000	171.450 6.7500	112.712 4.4375	77.788 3.0625	632000 142000	0.76	0.88	1.31	94100 21200	123000 27700	164000 36800	0.76
76.200 3.0000	171.450 6.7500	113.424 4.4655	78.500 3.0906	632000 142000	0.76	0.88	1.31	94100 21200	123000 27700	164000 36800	0.76
76.200 3.0000	180.975 7.1250	114.300 4.5000	77.790 3.0626	781000 175000	0.73	0.92	1.37	116000 26100	146000 32700	202000 45500	0.80
79.375 3.1250	190.500 7.5000	127.000 5.0000	104.775 4.1250	929000 209000	0.33	2.02	3.00	138000 31100	79300 17800	241000 54200	1.74
80.000 3.1496	130.000 5.1181	77.456 3.0495	64.452 2.5375	410000 92100	0.39	1.74	2.59	61000 13700	40600 9120	106000 23900	1.50
80.000 3.1496	140.000 5.5118	64.000 2.5196	51.500 2.0276	296000 66500	0.42	1.61	2.39	44000 9900	31700 7120	76700 17200	1.39
80.000 3.1496	140.000 5.5118	104.000 4.0945	82.000 3.2283	517000 116000	0.43	1.59	2.36	76900 17300	56000 12600	134000 30100	1.37
83.345 3.2813	125.412 4.9375	98.425 3.8750	87.315 3.4376	204000 45900	0.42	1.62	2.42	30400 6830	21600 4860	52900 11900	1.40

⁽¹⁾Overall width can vary depending on spacer selection. Contact your Timken engineer for more information.

⁽²⁾Based on 1×10^6 revolutions L_{10} life, for the ISO life-calculation method. $C_{1(2)}$ is the double-row radial value.

⁽³⁾Consult your Timken engineer for instructions on use or review the Timken Engineering Manual on timken.com/catalogs.

⁽⁴⁾Based on 90×10^6 revolutions L_{10} life, for The Timken Company life-calculation method. C_{90} and C_{a90} are radial and thrust values for single-row.

$C_{90(2)}$ is the double-row radial value.

Part Number				Dimensions				Bearing Weight
Inner	Outer	Inner Spacer ⁽⁵⁾	Outer Spacer ⁽⁵⁾	Shaft		Housing		
				Max. Shaft Fillet Radius	Backing Shoulder Dia.	Max. Housing Fillet Radius	Backing Shoulder Dia.	
				R ⁽⁶⁾	d _b	r ⁽⁶⁾	D _a	
				mm in.	mm in.	mm in.	mm in.	kg lbs.
X32014X	Y32014X	JX7006A	JYH11007TSR	1.5 0.06	78.0 3.07	0.5 0.02	105.0 4.13	1.85 4.11
JM612949	JM612910	M612949XA	M612910ES	3.0 0.12	83.0 3.27	0.6 0.03	110.0 4.33	2.36 5.23
29685	29620	X2S-29685	Y7S-29620	3.5 0.14	86.0 3.39	0.6 0.03	109.0 4.29	1.94 4.28
33287	33462	X4S-33287	Y6S-33462	3.5 0.14	88.0 3.46	0.8 0.03	112.0 4.41	3.38 7.43
JLM714149	JLM714110		XC14638-SC	3.0 0.12	88.0 3.46	0.5 0.02	110.5 4.35	1.80 3.94
JLM714149	JLM714110	LM714149XB	LM714110ES	3.0 0.12	88.0 3.46	0.5 0.02	110.5 4.35	1.88 4.12
JLM714149	JLM714110	LM714149XA	LM714110EA	3.0 0.12	88.0 3.46	0.5 0.02	110.5 4.35	2.26 4.98
9285	9220	X2S-9285	Y3S-9220	3.5 0.14	111.0 4.37	0.8 0.03	153.0 6.03	8.93 19.72
6575	6535	X1S-6575	Y1S-6535	6.4 0.25	104.0 4.09	0.8 0.03	154.0 6.06	11.20 24.68
9380	9321	X5S-9380	Y6S-9321	3.5 0.14	105.0 4.13	0.8 0.03	164.0 6.46	11.34 24.99
9380	9321	X1H9380		3.5 0.14	105.0 4.13	0.8 0.03	164.0 6.46	10.69 23.56
H917840	H917810	H917840XA	H917810EA	3.5 0.14	110.0 4.33	1.5 0.06	170.0 6.69	13.84 30.53
HH221431	HH221410	HH221431XA	HH221410EE	3.5 0.14	103.0 4.06	0.8 0.03	179.0 7.05	17.64 38.91
JM515649	JM515610	M515649XC	M515610ES	3.0 0.12	94.0 3.70	0.6 0.03	125.0 4.92	3.62 8.00
X30216M	Y30216M	K163675	K163676	2.5 0.10	94.0 3.70	1.0 0.04	133.0 5.24	3.57 7.86
X33216	Y33216	K161554	JYH14099R	2.5 0.10	97.0 3.82	0.5 0.02	135.0 5.31	6.30 13.88
27689	27620	X3S-27689	Y5S-27620	0.8 0.03	90.0 3.54	0.8 0.03	120.0 4.72	3.27 7.20

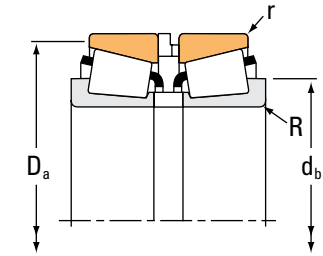
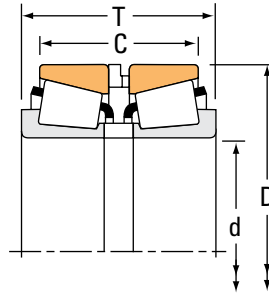
⁽⁵⁾Contact your Timken engineer for information on spacer configurations.

⁽⁶⁾These maximum fillet radii will be cleared by the bearing corners.

TAPERED ROLLER BEARINGS

DOUBLE-ROW • TYPE 2TS-IM

TYPE 2TS-IM



Bearing Dimensions				Load Ratings							
Bore d	O.D. D	Width ⁽¹⁾ T	Width C	Dynamic ⁽²⁾		Factors ⁽³⁾		Dynamic ⁽⁴⁾			Factors ⁽³⁾
				C ₁₍₂₎	e	Y ₁	Y ₂	C ₉₀	C _{a90}	C ₉₀₍₂₎	K
mm in.	mm in.	mm in.	mm in.	N lbf				N lbf	N lbf	N lbf	
85.000 3.3465	130.000 5.1181	65.491 2.5784	53.491 2.1060	281000 63100	0.44	1.52	2.26	41800 9400	31800 7150	72800 16400	1.31
85.000 3.3465	140.000 5.5118	85.470 3.3649	70.470 2.7744	490000 110000	0.41	1.66	2.47	73000 16400	50900 11400	127000 28600	1.43
85.000 3.3465	188.912 7.4375	112.944 4.4466	69.850 2.7500	667000 150000	0.87	0.78	1.16	99300 22300	147000 33100	173000 38900	0.67
85.725 3.3750	168.275 6.6250	184.125 7.2490	161.925 6.3750	461000 104000	0.47	1.43	2.14	68600 15400	55300 12400	119000 26900	1.24
88.900 3.5000	168.275 6.6250	122.212 4.8115	96.812 3.8115	844000 190000	0.30	2.26	3.36	126000 28300	64400 14500	219000 49200	1.95
89.975 3.5423	146.975 5.7864	127.000 5.0000	112.000 4.4094	565000 127000	0.33	2.03	3.02	84200 18900	47900 10800	147000 33000	1.76
90.000 3.5433	145.000 5.7087	78.491 3.0902	62.489 2.4602	387000 87000	0.44	1.52	2.26	57700 13000	43900 9860	100000 22600	1.31
90.000 3.5433	155.000 6.1024	97.314 3.8313	80.314 3.1619	683000 153000	0.34	1.98	2.95	102000 22900	59400 13300	177000 39800	1.71
90.000 3.5433	155.000 6.1024	127.000 5.0000	110.000 4.3306	683000 153000	0.34	1.98	2.95	102000 22900	59400 13300	177000 39800	1.71
95.250 3.7500	146.050 5.7500	80.975 3.1880	66.690 2.6256	343000 77100	0.45	1.51	2.24	51100 11500	39200 8810	88900 20000	1.30
95.250 3.7500	148.430 5.8437	66.675 2.6250	52.390 2.0626	336000 75600	0.49	1.37	2.04	50100 11300	42200 9480	87100 19600	1.19
95.250 3.7500	152.400 6.0000	79.375 3.1250	60.325 2.3750	376000 84600	0.44	1.53	2.27	56000 12600	42400 9530	97500 21900	1.32
95.250 3.7500	168.275 6.6250	212.725 8.3750	190.500 7.5000	461000 104000	0.47	1.43	2.14	68600 15400	55300 12400	119000 26900	1.24
96.838 3.8125	188.912 7.4375	107.950 4.2500	69.850 2.7500	667000 150000	0.87	0.78	1.16	99300 22300	147000 33100	173000 38900	0.67
96.838 3.8125	188.912 7.4375	114.300 4.5000	76.200 3.0000	667000 150000	0.87	0.78	1.16	99300 22300	147000 33100	173000 38900	0.67
99.975 3.9360	212.725 8.3750	142.875 5.6250	117.475 4.6250	1180000 266000	0.33	2.07	3.09	176000 39600	98300 22100	307000 69000	1.79
100.000 3.9370	155.000 6.1024	79.416 3.1266	63.419 2.4968	403000 90600	0.47	1.43	2.12	60000 13500	48600 10900	104000 23500	1.24

⁽¹⁾Overall width can vary depending on spacer selection. Contact your Timken engineer for more information.

⁽²⁾Based on 1×10^6 revolutions L_{10} life, for the ISO life-calculation method. $C_{1(2)}$ is the double-row radial value.

⁽³⁾Consult your Timken engineer for instructions on use or review the Timken Engineering Manual on timken.com/catalogs.

⁽⁴⁾Based on 90×10^6 revolutions L_{10} life, for The Timken Company life-calculation method. C_{90} and C_{a90} are radial and thrust values for single-row. $C_{90(2)}$ is the double-row radial value.

Part Number				Dimensions				Bearing Weight
Inner	Outer	Inner Spacer ⁽⁵⁾	Outer Spacer ⁽⁵⁾	Shaft		Housing		
				Max. Shaft Fillet Radius R ⁽⁶⁾	Backing Shoulder Dia. d _b	Max. Housing Fillet Radius r ⁽⁶⁾	Backing Shoulder Dia. D _a	
				mm in.	mm in.	mm in.	mm in.	kg lbs.
JM716649	JM716610	M716649XB	M716610ES	3.0 0.12	98.0 3.86	0.8 0.03	125.0 4.92	2.88 6.36
JHM516849	JHM516810	JX8599AI	HM516810ES	3.0 0.12	100.0 3.94	1.0 0.04	134.0 5.28	4.75 10.48
90334	90744	X1S-90334	Y4S-90744	3.5 0.14	116.0 4.57	1.5 0.06	179.0 7.06	13.59 29.94
677	672	X2S-677	Y5S-672	3.5 0.14	105.0 4.13	0.8 0.03	160.0 6.30	14.07 31.00
850	832	X4S-850	Y3S-832	3.5 0.14	106.0 4.17	0.8 0.03	155.0 6.10	10.64 23.43
HM218248	HM218210	HM218248XA	HM218210EB	7.0 0.28	112.0 4.41	0.8 0.03	141.0 5.55	5.60 12.33
JM718149	JM718110	M718149XA	M718110ES	3.0 0.12	106.0 4.17	1.0 0.04	138.8 5.46	4.59 10.12
JHM318448	JHM318410	HM318448XA	HM318410ES	3.0 0.12	106.0 4.17	0.8 0.03	148.0 5.83	6.97 15.33
JHM318448	JHM318410	JX9039A	JYH15539RSR	3.0 0.12	106.0 4.17	0.8 0.03	148.0 5.83	8.36 18.39
47896	47820	X2S-47896	Y3S-47820	3.5 0.14	110.0 4.33	0.8 0.03	140.0 5.51	4.38 9.65
42375	42584	X1S-42375	Y6S-42584	3.0 0.12	108.0 4.25	0.8 0.03	142.0 5.59	3.79 8.36
594	592A	X4S-594		3.5 0.14	110.0 4.33	0.8 0.03	144.0 5.67	5.03 11.09
683	672	X3S-683	Y7S-672	3.5 0.14	113.0 4.45	0.8 0.03	160.0 6.30	14.10 31.08
90381	90744	X4S-90381	Y4S-90744	3.5 0.14	125.0 4.92	1.5 0.06	179.0 7.06	11.64 25.65
90381	90744	X1S-90381	Y1S-90744	3.5 0.14	125.0 4.92	1.5 0.06	179.0 7.06	12.09 26.64
HH224334	HH224310	HH224334XA		3.5 0.14	124.0 4.88	0.8 0.03	201.7 7.94	22.81 50.28
JM720249	JM720210	M720249XA	M720210ES	3.0 0.12	115.0 4.53	0.8 0.03	149.0 5.87	5.01 11.03

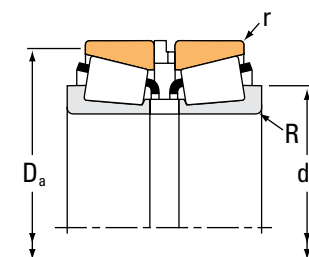
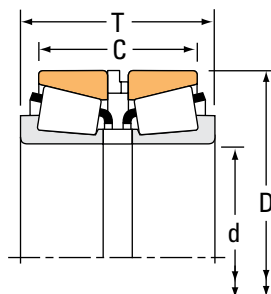
⁽⁵⁾Contact your Timken engineer for information on spacer configurations.

⁽⁶⁾These maximum fillet radii will be cleared by the bearing corners.

TAPERED ROLLER BEARINGS

DOUBLE-ROW • TYPE 2TS-IM

TYPE 2TS-IM



Bearing Dimensions				Load Ratings							
Bore d	O.D. D	Width ⁽¹⁾ T	Width C	Dynamic ⁽²⁾				Dynamic ⁽⁴⁾			
				C ₁₍₂₎	e	Factors ⁽³⁾ Y ₁	Y ₂	C ₉₀	C _{a90}	C ₉₀₍₂₎	Factors ⁽³⁾ K
mm in.	mm in.	mm in.	mm in.	N lbf				N lbf	N lbf	N lbf	
100.000 3.9370	160.000 6.2992	89.416 3.5203	71.412 2.8115	576000 130000	0.47	1.43	2.14	85800 19300	69100 15500	149000 33600	1.24
100.000 3.9370	180.000 7.0866	86.500 3.4055	70.500 2.7756	524000 118000	0.42	1.61	2.39	78000 17500	56100 12600	136000 30500	1.39
101.600 4.0000	168.275 6.6250	83.718 3.3000	66.493 2.6174	461000 104000	0.47	1.43	2.14	68600 15400	55300 12400	119000 26900	1.24
101.600 4.0000	190.500 7.5000	153.416 6.0400	128.016 5.0400	797000 179000	0.33	2.02	3.00	119000 26700	68000 15300	207000 46400	1.74
101.600 4.0000	190.500 7.5000	157.836 6.2140	132.436 5.2140	797000 179000	0.33	2.02	3.00	119000 26700	68000 15300	207000 46400	1.74
101.600 4.0000	190.500 7.5000	189.586 7.4640	167.361 6.5890	929000 209000	0.33	2.02	3.00	138000 31100	79300 17800	241000 54200	1.74
101.600 4.0000	250.825 9.8750	161.925 6.3750	111.125 4.3750	1440000 324000	0.70	0.97	1.44	215000 48200	257000 57800	374000 84000	0.84
101.600 4.0000	250.825 9.8750	165.100 6.5000	114.300 4.5000	1440000 324000	0.70	0.97	1.44	215000 48200	257000 57800	374000 84000	0.84
101.600 4.0000	250.825 9.8750	204.521 8.0520	153.721 6.0520	1440000 324000	0.70	0.97	1.44	215000 48200	257000 57800	374000 84000	0.84
107.950 4.2500	142.083 5.5938	41.935 1.6510	34.001 1.3386	123000 27500	0.39	1.72	2.57	18200 4100	12200 2750	31800 7140	1.49
107.950 4.2500	158.750 6.2500	50.002 1.9686	35.712 1.4060	238000 53400	0.61	1.11	1.66	35400 7960	36700 8250	61600 13900	0.96
107.950 4.2500	161.925 6.3750	82.550 3.2500	66.675 2.6250	334000 75200	0.51	1.34	1.99	49800 11200	43100 9680	86700 19500	1.16
109.987 4.3302	159.987 6.2987	74.612 2.9375	58.738 2.3125	341000 76600	0.40	1.68	2.50	50700 11400	34900 7850	88400 19900	1.45
110.000 4.3307	165.000 6.4961	79.413 3.1266	62.413 2.4572	396000 88900	0.50	1.36	2.02	58900 13200	50100 11300	103000 23100	1.18
110.000 4.3307	180.000 7.0866	102.365 4.0301	84.365 3.3215	647000 145000	0.41	1.66	2.48	96300 21600	66900 15000	168000 37700	1.44
110.000 4.3307	180.000 7.0866	102.365 4.0301	84.365 3.3215	766000 172000	0.41	1.66	2.48	114000 25700	79200 17800	199000 44700	1.44
114.300 4.5000	152.400 6.0000	47.625 1.8750	38.100 1.5000	206000 46300	0.41	1.63	2.43	30600 6890	21700 4870	53400 12000	1.41

⁽¹⁾Overall width can vary depending on spacer selection. Contact your Timken engineer for more information.

⁽²⁾Based on 1×10^6 revolutions L_{10} life, for the ISO life-calculation method. $C_{1(2)}$ is the double-row radial value.

⁽³⁾Consult your Timken engineer for instructions on use or review the Timken Engineering Manual on timken.com/catalogs.

⁽⁴⁾Based on 90×10^6 revolutions L_{10} life, for The Timken Company life-calculation method. C_{90} and C_{a90} are radial and thrust values for single-row. $C_{90(2)}$ is the double-row radial value.

Part Number				Dimensions				Bearing Weight
Inner	Outer	Inner Spacer ⁽⁵⁾	Outer Spacer ⁽⁵⁾	Shaft		Housing		
				Max. Shaft Fillet Radius	Backing Shoulder Dia.	Max. Housing Fillet Radius	Backing Shoulder Dia.	
				R ⁽⁶⁾	d _b	r ⁽⁶⁾	D _a	
				mm in.	mm in.	mm in.	mm in.	kg lbs.
JHM720249	JHM720210	M720249XB	HM720210ES	3.0 0.12	117.0 4.61	0.8 0.03	153.9 6.06	6.28 13.83
X30220M	Y30220M	K161564	K161563	3.0 0.12	119.0 4.69	1.0 0.04	169.0 6.65	8.21 18.10
687	672	X2S-687	Y5S-672	3.5 0.14	118.0 4.65	0.8 0.03	160.0 6.30	12.46 27.46
861	854	X8S-861	Y12S-854	8.0 0.31	129.0 5.08	0.8 0.03	174.0 6.85	16.58 36.55
861	854	X9S-861	Y14S-854	8.0 0.31	129.0 5.08	0.8 0.03	174.0 6.85	17.05 37.58
HH221449	HH221410	HH221449XS	HH221410ER	8.0 0.31	131.0 5.16	0.8 0.03	179.0 7.05	18.79 41.47
HH923649	HH923610	K84216	K84217	6.4 0.25	149.0 5.87	1.5 0.06	228.8 9.01	35.84 79.03
HH923649	HH923610	HH923649XA	K84215	6.4 0.25	149.0 5.87	1.5 0.06	228.8 9.01	35.93 79.22
HH923649	HH923610	HH923649XC	HH923610ES	6.4 0.25	149.0 5.87	1.5 0.06	228.8 9.01	41.48 91.46
LL521849C	LL521811	LL521849XB	LL521811EA	1.5 0.06	115.0 4.53	0.8 0.03	137.0 5.39	1.48 3.27
37425	37625	X6S-37425		3.5 0.14	122.0 4.80	0.8 0.03	152.0 5.98	2.85 6.26
48190	48120	X3S-48190		3.5 0.14	122.0 4.80	0.8 0.03	156.0 6.14	4.81 10.63
LM522548	LM522510	LM522549XA		8.0 0.31	133.0 5.24	0.8 0.03	154.0 6.06	4.40 9.69
JM822049	JM822010	M822049XA	M822010ES	3.0 0.12	125.0 4.92	0.8 0.03	159.0 6.26	5.30 11.73
JHM522649	JHM522610	HM522649XA	HM522610ES	3.0 0.12	127.0 5.00	0.8 0.03	172.0 6.77	9.41 20.70
JHM522649AC	JHM522610	HM522649XA	HM522610ES	7.0 0.28	138.0 5.43	0.8 0.03	172.0 6.77	9.37 20.62
L623149	L623110	L623149XB	L623110EA	1.5 0.06	123.0 4.84	0.8 0.03	147.0 5.79	2.22 4.90

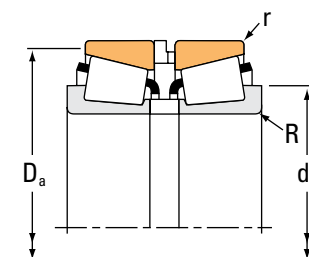
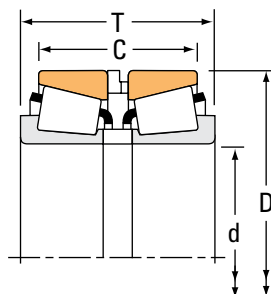
⁽⁵⁾Contact your Timken engineer for information on spacer configurations.

⁽⁶⁾These maximum fillet radii will be cleared by the bearing corners.

TAPERED ROLLER BEARINGS

DOUBLE-ROW • TYPE 2TS-IM

TYPE 2TS-IM



Bearing Dimensions				Load Ratings							
Bore d	O.D. D	Width ⁽¹⁾ T	Width C	Dynamic ⁽²⁾				Dynamic ⁽⁴⁾			
				C ₁₍₂₎	e	Factors ⁽³⁾ Y ₁	Y ₂	C ₉₀	C _{a90}	C ₉₀₍₂₎	Factors ⁽³⁾ K
mm in.	mm in.	mm in.	mm in.	N lbf				N lbf	N lbf	N lbf	
114.300 4.5000	177.800 7.0000	92.075 3.6250	69.850 2.7500	478000 108000	0.52	1.31	1.95	71200 16000	62900 14100	124000 27900	1.13
114.300 4.5000	212.725 8.3750	142.875 5.6250	117.475 4.6250	996000 224000	0.33	2.07	3.09	148000 33300	82700 18600	258000 58000	1.79
114.300 4.5000	212.725 8.3750	150.350 5.9193	124.950 4.9193	1180000 266000	0.33	2.07	3.09	176000 39600	98300 22100	307000 69000	1.79
114.300 4.5000	212.725 8.3750	152.400 6.0000	127.000 5.0000	996000 224000	0.33	2.07	3.09	148000 33300	82700 18600	258000 58000	1.79
114.300 4.5000	228.600 9.0000	212.725 8.3750	180.975 7.1250	1020000 230000	0.74	0.92	1.36	152000 34200	192000 43100	265000 59500	0.79
114.300 4.5000	273.050 10.7500	269.875 10.6250	212.725 8.3750	1850000 417000	0.63	1.07	1.59	276000 62100	299000 67200	481000 108000	0.92
114.300 4.5000	279.400 11.0000	184.150 7.2500	127.000 5.0000	1850000 417000	0.63	1.07	1.59	276000 62100	299000 67200	481000 108000	0.92
115.087 4.5310	190.500 7.5000	106.350 4.1870	80.950 3.1870	633000 142000	0.42	1.62	2.42	94300 21200	67100 15100	164000 36900	1.40
120.000 4.7244	170.000 6.6929	60.250 2.3720	45.250 1.7815	341000 76700	0.47	1.43	2.12	50800 11400	41100 9250	88500 19900	1.24
120.000 4.7244	215.000 8.4646	99.000 3.8976	80.000 3.1496	690000 155000	0.44	1.55	2.31	103000 23100	76500 17200	179000 40200	1.34
120.000 4.7244	215.000 8.4646	146.000 5.7480	123.000 4.8425	1020000 229000	0.44	1.55	2.31	152000 34100	113000 25400	264000 59400	1.34
120.650 4.7500	160.338 6.3125	52.291 2.0587	42.766 1.6837	170000 38200	0.43	1.55	2.31	25300 5680	18800 4230	44000 9890	1.34
120.650 4.7500	234.950 9.2500	157.734 6.2100	129.159 5.0850	1090000 246000	0.37	1.83	2.72	163000 36700	103000 23200	284000 63800	1.58
120.650 4.7500	273.050 10.7500	177.800 7.0000	120.650 4.7500	1850000 417000	0.63	1.07	1.59	276000 62100	299000 67200	481000 108000	0.92
125.298 4.9330	228.600 9.0000	115.888 4.5625	84.138 3.3125	1020000 230000	0.74	0.92	1.36	152000 34200	192000 43100	265000 59500	0.79
127.000 5.0000	182.562 7.1875	85.725 3.3750	73.025 2.8750	466000 105000	0.31	2.21	3.29	69400 15600	36300 8160	121000 27200	1.91
127.000 5.0000	196.850 7.7500	101.600 4.0000	85.725 3.3750	640000 144000	0.34	1.96	2.92	95300 21400	56100 12600	166000 37300	1.70

⁽¹⁾Overall width can vary depending on spacer selection. Contact your Timken engineer for more information.

⁽²⁾Based on 1×10^6 revolutions L_{10} life, for the ISO life-calculation method. $C_{1(2)}$ is the double-row radial value.

⁽³⁾Consult your Timken engineer for instructions on use or review the Timken Engineering Manual on timken.com/catalogs.

⁽⁴⁾Based on 90×10^6 revolutions L_{10} life, for The Timken Company life-calculation method. C_{90} and C_{a90} are radial and thrust values for single-row.

$C_{90(2)}$ is the double-row radial value.

Part Number				Dimensions				Bearing Weight
Inner	Outer	Inner Spacer ⁽⁵⁾	Outer Spacer ⁽⁵⁾	Shaft		Housing		
				Max. Shaft Fillet Radius	Backing Shoulder Dia.	Max. Housing Fillet Radius	Backing Shoulder Dia.	
				R ⁽⁶⁾	d _b	r ⁽⁶⁾	D _a	
				mm	mm	mm	mm	kg
				in.	in.	in.	in.	lbs.
64450	64700	X1S-64450	Y8S-64700	3.5 0.14	131.0 5.16	0.8 0.03	172.0 6.77	7.39 16.32
938	932	X9S-938	Y14S-932	7.0 0.28	141.0 5.55	0.8 0.03	193.1 7.60	20.30 44.77
HH224346	HH224310	HH224346XC	HH224310EX	7.0 0.28	143.0 5.63	0.8 0.03	201.7 7.94	20.74 45.71
938	932	X7S-938	Y10S-932	7.0 0.28	141.0 5.55	0.8 0.03	193.1 7.60	21.29 46.97
HM926740	HM926710	HM926740XE	HM926710ER	3.5 0.14	146.0 5.75	0.8 0.03	219.3 8.63	32.84 72.41
HH926744	HH926710	HH926744XE	HH926710EX	6.4 0.25	164.0 6.46	1.5 0.06	253.3 9.97	63.58 140.13
HH926744	HH926716	HH926744XB	HH926716EB	6.4 0.25	164.0 6.46	1.5 0.06	253.3 9.97	48.94 107.87
71453	71750	X2S-71453		3.5 0.14	133.0 5.24	0.8 0.03	181.0 7.13	10.30 22.72
JP12049	JP12010		JYH17006R	3.0 0.12	133.0 5.24	0.8 0.03	164.5 6.48	3.54 7.85
X30224M	Y30224M	K161562	K161561	3.0 0.12	140.0 5.51	1.0 0.04	201.0 7.91	13.52 29.79
X32224M	Y32224M	JX12030AM	JY21523RM	3.0 0.12	147.0 5.79	1.0 0.04	204.5 8.05	20.52 45.23
L624549	L624510	L624549XS	L624510EE	1.5 0.06	129.0 5.08	0.8 0.03	155.0 6.10	2.66 5.84
95475	95925	X4S-95475		6.4 0.25	149.0 5.87	1.5 0.06	217.0 8.54	25.92 57.19
HH926749	HH926710	HH926749XA	HH926710EA	6.4 0.25	168.0 6.61	1.5 0.06	253.3 9.97	44.65 98.40
HM926745	HM926710	HM926745XA	HM926710EB	3.5 0.14	154.0 6.06	0.8 0.03	219.3 8.63	18.45 40.67
48290	48220	X1S-48290	Y7S-48220	3.5 0.14	141.0 5.55	0.8 0.03	176.0 6.93	6.89 15.21
67388	67322	X1S-67388	Y2S-67322	3.5 0.14	144.0 5.67	1.5 0.06	189.0 7.44	10.69 23.59

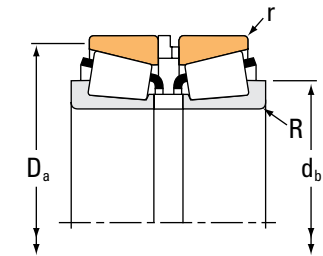
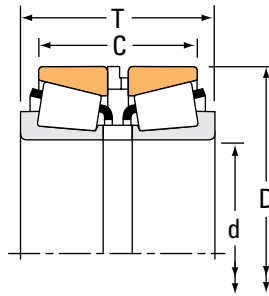
⁽⁵⁾Contact your Timken engineer for information on spacer configurations.

⁽⁶⁾These maximum fillet radii will be cleared by the bearing corners.

TAPERED ROLLER BEARINGS

DOUBLE-ROW • TYPE 2TS-IM

TYPE 2TS-IM



Bearing Dimensions				Load Ratings							
Bore d	O.D. D	Width ⁽¹⁾ T	Width C	Dynamic ⁽²⁾		Factors ⁽³⁾		Dynamic ⁽⁴⁾			Factors ⁽³⁾
mm in.	mm in.	mm in.	mm in.	C ₁₍₂₎	e	Y ₁	Y ₂	C ₉₀	C _{a90}	C ₉₀₍₂₎	K
N lbf	N lbf	N lbf	N lbf	N lbf	N lbf	N lbf	N lbf	N lbf	N lbf	N lbf	N lbf
127.000 5.0000	228.600 9.0000	158.750 6.2500	127.000 5.0000	1020000 230000	0.74	0.92	1.36	152000 34200	192000 43100	265000 59500	0.79
127.000 5.0000	304.800 12.0000	190.500 7.5000	127.000 5.0000	2020000 453000	0.73	0.93	1.38	300000 67500	374000 84100	522000 117000	0.80
127.792 5.0312	228.600 9.0000	115.888 4.5625	84.138 3.3125	1020000 230000	0.74	0.92	1.36	152000 34200	192000 43100	265000 59500	0.79
129.967 5.1168	219.975 8.6604	180.300 7.0984	154.900 6.0984	797000 179000	0.32	2.12	3.15	119000 26700	64800 14600	207000 46500	1.83
130.000 5.1181	185.000 7.2835	69.000 2.7165	53.000 2.0866	341000 76700	0.47	1.43	2.12	50800 11400	41100 9250	88400 19900	1.24
130.000 5.1181	230.000 9.0551	149.500 5.8858	122.000 4.8031	1190000 267000	0.44	1.55	2.31	177000 39800	132000 29600	308000 69200	1.34
133.350 5.2500	215.900 8.5000	222.250 8.7500	196.850 7.7500	665000 150000	0.49	1.38	2.06	99000 22300	82600 18600	172000 38800	1.20
133.350 5.2500	234.950 9.2500	138.500 5.4528	109.926 4.3278	1090000 246000	0.37	1.83	2.72	163000 36700	103000 23200	284000 63800	1.58
136.525 5.3750	190.500 7.5000	88.694 3.4919	75.994 2.9919	492000 111000	0.32	2.10	3.13	73300 16500	40300 9060	128000 28700	1.82
139.700 5.5000	215.900 8.5000	101.600 4.0000	76.200 3.0000	665000 150000	0.49	1.38	2.06	99000 22300	82600 18600	172000 38800	1.20
139.700 5.5000	228.600 9.0000	123.825 4.8750	98.425 3.8750	906000 204000	0.42	1.60	2.39	135000 30300	97200 21800	235000 52800	1.39
139.700 5.5000	295.275 11.6250	238.125 9.3750	187.325 7.3750	1990000 447000	0.32	2.12	3.15	296000 66600	162000 36300	516000 116000	1.83
139.700 5.5000	304.800 12.0000	212.725 8.3750	174.625 6.8750	1350000 303000	0.33	2.03	3.02	201000 45200	114000 25700	350000 78700	1.76
139.700 5.5000	307.975 12.1250	298.450 11.7500	254.000 10.0000	2010000 451000	0.33	2.07	3.08	299000 67200	167000 37500	520000 117000	1.79
140.000 5.5118	210.000 8.2677	98.000 3.8583	76.000 2.9921	685000 154000	0.46	1.47	2.19	102000 22900	80000 18000	177000 39900	1.27
146.050 5.7500	203.200 8.0000	88.900 3.5000	77.790 3.0626	342000 76900	0.37	1.83	2.73	50900 11400	32100 7220	88600 19900	1.59
146.050 5.7500	268.288 10.5625	164.225 6.4656	129.300 5.0910	1620000 364000	0.39	1.74	2.59	241000 54200	160000 35900	420000 94300	1.51

⁽¹⁾Overall width can vary depending on spacer selection. Contact your Timken engineer for more information.

⁽²⁾Based on 1×10^6 revolutions L_{10} life, for the ISO life-calculation method. $C_{1(2)}$ is the double-row radial value.

⁽³⁾Consult your Timken engineer for instructions on use or review the Timken Engineering Manual on timken.com/catalogs.

⁽⁴⁾Based on 90×10^6 revolutions L_{10} life, for The Timken Company life-calculation method. C_{90} and C_{a90} are radial and thrust values for single-row.

$C_{90(2)}$ is the double-row radial value.

Part Number				Dimensions				Bearing Weight
Inner	Outer	Inner Spacer ⁽⁵⁾	Outer Spacer ⁽⁵⁾	Shaft		Housing		
				Max. Shaft Fillet Radius R ⁽⁶⁾	Backing Shoulder Dia. d _b	Max. Housing Fillet Radius r ⁽⁶⁾	Backing Shoulder Dia. D _a	
				mm in.	mm in.	mm in.	mm in.	kg lbs.
HM926747	HM926710	HM926747XE		3.5 0.14	156.0 6.14	0.8 0.03	219.3 8.63	19.05 42.03
HH932132	HH932110	HH932132XA	HH932110EA	6.4 0.25	182.0 7.17	1.5 0.06	288.0 11.34	63.69 140.42
HM926749	HM926710	HM926749XE	HM926710EB	3.5 0.14	156.0 6.14	0.8 0.03	219.3 8.63	18.15 40.05
HM227545	HM227519	HM227545XB	HM227519EE	3.3 0.13	147.0 5.79	1.5 0.06	202.0 7.95	21.67 47.75
JP13049	JP13010	K160157	K160158	3.0 0.12	143.0 5.63	0.8 0.03	179.0 7.05	4.76 10.49
X32226M	Y32226M	K161556	K161555	4.0 0.16	161.0 6.34	1.0 0.04	219.0 8.62	24.07 53.10
74525	74850	X3S-74525	Y6S-74850	3.5 0.14	152.0 5.98	0.8 0.03	208.0 8.19	24.63 54.26
95525	95925	K160046	K160047	9.7 0.38	166.0 6.54	1.5 0.06	217.0 8.54	23.24 51.25
48393	48320	X6S-48393		3.5 0.14	151.0 5.94	0.8 0.03	184.0 7.24	6.93 15.29
74550	74850	X11S-74550	Y17S-74850	3.5 0.14	158.0 6.22	0.8 0.03	208.0 8.19	12.46 27.44
898	892	X4S-898	Y5S-892	3.5 0.14	160.0 6.30	1.5 0.06	216.0 8.50	18.15 40.03
HH231649	HH231615	HH231649XB		9.7 0.38	177.0 6.97	1.5 0.06	263.7 10.38	52.27 115.25
EE750558	751200	X1S-750558	Y5S-751200	3.3 0.13	162.0 6.38	1.5 0.06	272.0 10.71	57.83 127.55
HH234031	HH234010	HH234031XA		9.7 0.38	180.0 7.09	2.3 0.09	285.5 11.24	68.72 151.47
X32028XM	Y32028XM	K167398	K167397	2.5 0.10	158.0 6.22	0.6 0.03	203.0 7.99	11.04 24.32
36690	36626	X4S-36690	Y1S-36626	1.5 0.06	155.0 6.10	0.8 0.03	190.0 7.48	7.62 16.81
NP655864	107105	K167806	K167807	6.4 0.25	176.0 6.93	1.5 0.06	249.4 9.82	37.62 82.91

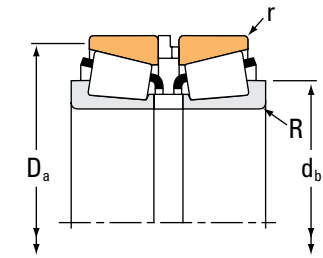
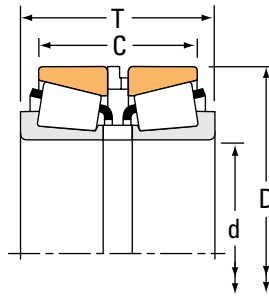
⁽⁵⁾Contact your Timken engineer for information on spacer configurations.

⁽⁶⁾These maximum fillet radii will be cleared by the bearing corners.

TAPERED ROLLER BEARINGS

DOUBLE-ROW • TYPE 2TS-IM

TYPE 2TS-IM



Bearing Dimensions				Load Ratings							
Bore d	O.D. D	Width ⁽¹⁾ T	Width C	Dynamic ⁽²⁾		Factors ⁽³⁾		Dynamic ⁽⁴⁾			Factors ⁽³⁾
mm in.	mm in.	mm in.	mm in.	C ₁₍₂₎	e	Y ₁	Y ₂	C ₉₀	C _{a90}	C ₉₀₍₂₎	K
N lbf	N lbf	N lbf	N lbf	N lbf	N lbf	N lbf	N lbf	N lbf	N lbf	N lbf	N lbf
146.050 5.7500	304.800 12.0000	190.500 7.5000	127.000 5.0000	2020000 453000	0.73	0.93	1.38	300000 67500	374000 84100	522000 117000	0.80
146.050 5.7500	304.800 12.0000	202.800 7.9843	139.300 5.4843	2020000 453000	0.73	0.93	1.38	300000 67500	374000 84100	522000 117000	0.80
146.050 5.7500	311.150 12.2500	190.500 7.5000	127.000 5.0000	2020000 453000	0.73	0.93	1.38	300000 67500	374000 84100	522000 117000	0.80
149.225 5.8750	236.538 9.3125	135.000 5.3150	109.600 4.3150	1040000 234000	0.32	2.12	3.15	155000 34800	84500 19000	269000 60600	1.83
149.225 5.8750	236.538 9.3125	158.000 6.2205	132.600 5.2205	1040000 234000	0.32	2.12	3.15	155000 34800	84500 19000	269000 60600	1.83
149.225 5.8750	241.300 9.5000	155.575 6.1250	130.175 5.1250	1040000 234000	0.32	2.12	3.15	155000 34800	84500 19000	269000 60600	1.83
152.400 6.0000	268.288 10.5625	165.100 6.5000	130.175 5.1250	1370000 307000	0.39	1.74	2.59	203000 45700	135000 30300	354000 79600	1.51
155.575 6.1250	330.200 13.0000	180.975 7.1250	117.475 4.6250	2140000 481000	0.81	0.83	1.24	319000 71600	441000 99200	555000 125000	0.72
155.575 6.1250	330.200 13.0000	190.500 7.5000	127.000 5.0000	2140000 481000	0.81	0.83	1.24	319000 71600	441000 99200	555000 125000	0.72
165.100 6.5000	225.425 8.8750	104.775 4.1250	88.900 3.5000	528000 119000	0.38	1.76	2.62	78600 17700	51600 11600	137000 30800	1.52
165.100 6.5000	336.550 13.2500	203.200 8.0000	158.750 6.2500	2880000 648000	0.37	1.82	2.71	429000 96500	273000 61400	748000 168000	1.57
168.275 6.6250	330.200 13.0000	184.150 7.2500	120.650 4.7500	2140000 481000	0.81	0.83	1.24	319000 71600	441000 99200	555000 125000	0.72
168.275 6.6250	330.200 13.0000	190.500 7.5000	127.000 5.0000	2140000 481000	0.81	0.83	1.24	319000 71600	441000 99200	555000 125000	0.72
168.275 6.6250	342.900 13.5000	180.975 7.1250	117.475 4.6250	2140000 481000	0.81	0.83	1.24	319000 71600	441000 99200	555000 125000	0.72
169.975 6.6919	260.350 10.2500	149.225 5.8750	120.650 4.7500	1140000 256000	0.40	1.68	2.50	169000 38100	117000 26200	295000 66300	1.45
170.000 6.6929	230.000 9.0551	87.239 3.4346	71.242 2.8048	583000 131000	0.38	1.76	2.62	86800 19500	56900 12800	151000 34000	1.52
170.000 6.6929	240.000 9.4488	100.278 3.9479	82.278 3.2393	699000 157000	0.44	1.54	2.30	104000 23400	77900 17500	181000 40700	1.34

⁽¹⁾Overall width can vary depending on spacer selection. Contact your Timken engineer for more information.

⁽²⁾Based on 1×10^6 revolutions L_{10} life, for the ISO life-calculation method. $C_{1(2)}$ is the double-row radial value.

⁽³⁾Consult your Timken engineer for instructions on use or review the Timken Engineering Manual on timken.com/catalogs.

⁽⁴⁾Based on 90×10^6 revolutions L_{10} life, for The Timken Company life-calculation method. C_{90} and C_{a90} are radial and thrust values for single-row.

$C_{90(2)}$ is the double-row radial value.

Part Number				Dimensions				Bearing Weight
Inner	Outer	Inner Spacer ⁽⁵⁾	Outer Spacer ⁽⁵⁾	Shaft		Housing		
				Max. Shaft Fillet Radius	Backing Shoulder Dia.	Max. Housing Fillet Radius	Backing Shoulder Dia.	
				R ⁽⁶⁾	d _b	r ⁽⁶⁾	D _a	
				mm	mm	mm	mm	kg
				in.	in.	in.	in.	lbs.
HH932145	HH932110	HH932145XA	HH932110EB	6.4 0.25	195.0 7.68	1.5 0.06	288.0 11.34	56.95 125.55
HH932145	HH932110	HH932145XE		6.4 0.25	195.0 7.68	1.5 0.06	288.0 11.34	55.68 122.76
HH932145	HH932115	HH932145XA	HH932115EC	6.4 0.25	195.0 7.68	1.5 0.06	288.0 11.34	60.41 133.18
HM231148	HM231110	HM231148XB	HM231110EE	6.4 0.25	172.0 6.77	1.5 0.06	224.0 8.82	19.80 43.61
HM231148	HM231110	HM231148XE	HM231110ES	6.4 0.25	172.0 6.77	1.5 0.06	224.0 8.82	22.18 48.85
HM231149	HM231115	HM231149XC	HM231115EC	3.5 0.14	167.0 6.57	1.5 0.06	224.0 8.82	22.24 49.01
EE107060	107105	X7S-99600	K160929	6.4 0.25	181.0 7.13	1.5 0.06	249.4 9.82	35.45 78.13
H936340	H936310	H936340XE	H936310EE	6.4 0.25	209.0 8.23	1.5 0.06	311.4 12.26	66.72 147.09
H936340	H936310	H936340XA	H936310EC	6.4 0.25	209.0 8.23	1.5 0.06	311.4 12.26	68.83 151.74
46790	46720	X4S-46790	K160550	3.5 0.14	181.0 7.13	0.8 0.03	218.0 8.58	11.24 24.77
HH437549	HH437510	HH437549XA		3.3 0.13	196.0 7.72	1.5 0.06	307.7 12.12	75.73 166.96
H936349	H936310	H936349XC	H936310EG	6.4 0.25	218.0 8.58	1.5 0.06	311.4 12.26	63.04 138.98
H936349	H936310	H936349XS	H936310EC	6.4 0.25	218.0 8.58	1.5 0.06	311.4 12.26	64.39 141.94
H936349	H936316	H936349XB	H936316EG	6.4 0.25	218.0 8.58	1.5 0.06	311.4 12.26	67.71 149.26
HM535347	HM535310	HM535347XA	HM535310ES	3.5 0.14	192.0 7.56	0.8 0.03	250.0 9.84	27.57 60.79
JHM534149	JHM534110	HM534149XA	HM534110ES	3.0 0.12	184.0 7.24	0.4 0.02	224.0 8.82	9.09 19.99
JM734449	JM734410	M734449XB	M734410ES	3.0 0.12	185.0 7.28	1.5 0.06	232.0 9.13	13.18 29.04

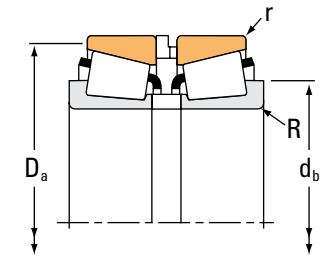
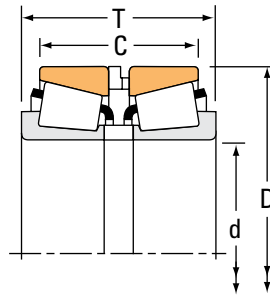
⁽⁵⁾Contact your Timken engineer for information on spacer configurations.

⁽⁶⁾These maximum fillet radii will be cleared by the bearing corners.

TAPERED ROLLER BEARINGS

DOUBLE-ROW • TYPE 2TS-IM

TYPE 2TS-IM



Bearing Dimensions				Load Ratings							
Bore d	O.D. D	Width ⁽¹⁾ T	Width C	Dynamic ⁽²⁾				Dynamic ⁽⁴⁾			
				C ₁₍₂₎	e	Factors ⁽³⁾ Y ₁	Y ₂	C ₉₀	C _{a90}	C ₉₀₍₂₎	Factors ⁽³⁾ K
mm in.	mm in.	mm in.	mm in.	N lbf				N lbf	N lbf	N lbf	
170.000 6.6929	240.000 9.4488	100.278 3.9479	82.278 3.2393	667000 150000	0.44	1.54	2.30	99300 22300	74300 16700	173000 38900	1.34
171.450 6.7500	260.350 10.2500	147.498 5.8070	118.922 4.6820	1140000 256000	0.40	1.68	2.50	169000 38100	117000 26200	295000 66300	1.45
171.450 6.7500	260.350 10.2500	155.575 6.1250	127.000 5.0000	1140000 256000	0.40	1.68	2.50	169000 38100	117000 26200	295000 66300	1.45
171.450 6.7500	260.350 10.2500	203.200 8.0000	174.625 6.8750	1140000 256000	0.40	1.68	2.50	169000 38100	117000 26200	295000 66300	1.45
174.625 6.8750	298.450 11.7500	185.738 7.3125	147.638 5.8125	1610000 363000	0.38	1.79	2.66	240000 54000	155000 34900	419000 94100	1.55
174.625 6.8750	311.150 12.2500	184.150 7.2500	149.225 5.8750	1950000 438000	0.33	2.04	3.04	290000 65200	164000 36900	505000 114000	1.77
177.800 7.0000	247.650 9.7500	103.188 4.0625	84.138 3.3125	705000 159000	0.44	1.54	2.29	105000 23600	79000 17800	183000 41100	1.33
177.800 7.0000	247.650 9.7500	106.362 4.1875	87.312 3.4375	705000 159000	0.44	1.54	2.29	105000 23600	79000 17800	183000 41100	1.33
177.800 7.0000	288.925 11.3750	142.875 5.6250	111.125 4.3750	1700000 382000	0.32	2.12	3.15	253000 56900	138000 31100	441000 99100	1.83
177.800 7.0000	288.925 11.3750	158.750 6.2500	127.000 5.0000	1150000 258000	0.47	1.44	2.15	171000 38500	137000 30800	298000 67000	1.25
177.800 7.0000	355.600 14.0000	190.500 7.5000	139.700 5.5000	1850000 416000	0.55	1.24	1.84	276000 62000	258000 57900	480000 108000	1.07
177.800 7.0000	428.625 16.8750	228.600 9.0000	139.700 5.5000	2620000 588000	0.76	0.89	1.33	390000 87600	506000 114000	679000 153000	0.77
180.000 7.0866	250.000 9.8425	102.288 4.0271	82.288 3.2397	712000 160000	0.48	1.41	2.09	106000 23800	87200 19600	185000 41500	1.22
189.949 7.4783	290.000 11.4173	138.000 5.4331	107.396 4.2282	975000 219000	0.33	2.03	3.02	145000 32600	82600 18600	253000 56800	1.76
190.000 7.4803	260.000 10.2362	101.262 3.9867	82.263 3.2387	708000 159000	0.48	1.41	2.11	105000 23700	86200 19400	184000 41300	1.22
190.000 7.4803	290.000 11.4173	146.000 5.7480	114.000 4.4882	1250000 281000	0.44	1.53	2.27	186000 41900	141000 31700	325000 73000	1.32
190.500 7.5000	336.550 13.2500	209.550 8.2500	158.750 6.2500	2010000 451000	0.58	1.17	1.75	299000 67100	294000 66200	520000 117000	1.01

⁽¹⁾Overall width can vary depending on spacer selection. Contact your Timken engineer for more information.

⁽²⁾Based on 1×10^6 revolutions L_{10} life, for the ISO life-calculation method. $C_{1(2)}$ is the double-row radial value.

⁽³⁾Consult your Timken engineer for instructions on use or review the Timken Engineering Manual on timken.com/catalogs.

⁽⁴⁾Based on 90×10^6 revolutions L_{10} life, for The Timken Company life-calculation method. C_{90} and C_{a90} are radial and thrust values for single-row.

$C_{90(2)}$ is the double-row radial value.

Part Number				Dimensions				Bearing Weight
Inner	Outer	Inner Spacer ⁽⁵⁾	Outer Spacer ⁽⁵⁾	Shaft		Housing		
				Max. Shaft Fillet Radius	Backing Shoulder Dia.	Max. Housing Fillet Radius	Backing Shoulder Dia.	
				R ⁽⁶⁾	d _b	r ⁽⁶⁾	D _a	
				mm	mm	mm	mm	kg
				in.	in.	in.	in.	lbs.
JM734449A	JM734410	M734449XB	M734410ES	3.0 0.12	185.0 7.28	1.5 0.06	232.0 9.13	13.14 28.94
HM535349	HM535310	HM535349XE	HM535310EX	3.5 0.14	192.0 7.56	0.8 0.03	250.0 9.84	25.96 57.25
HM535349	HM535310	HM535349XS	HM535310EW	3.5 0.14	192.0 7.56	0.8 0.03	250.0 9.84	26.60 58.66
HM535349	HM535310	HM535349XB	HM535310EE	3.5 0.14	192.0 7.56	0.8 0.03	250.0 9.84	31.72 69.94
EE219068	219117	X2S-219068	Y1S-219117	6.4 0.25	204.0 8.03	1.5 0.06	282.0 11.10	48.04 105.93
H238148	H238110	H238148XA		6.4 0.25	205.0 8.07	1.5 0.06	289.0 11.36	52.37 115.45
67790	67720	K164782	K164781	3.5 0.14	194.0 7.64	0.8 0.03	240.0 9.45	13.77 30.35
67790	67720	X6S-67790	Y9S-67720	3.5 0.14	194.0 7.64	0.8 0.03	240.0 9.45	14.13 31.16
HM237545	HM237510	HM237545XC	HM237510CA	7.0 0.28	205.0 8.07	1.5 0.06	271.3 10.68	32.11 70.82
94700	94113	X13S-94700	Y20S-94113	7.0 0.28	207.0 8.15	1.5 0.06	272.0 10.71	35.99 79.37
EE607070	607140	X2S-607070	Y4S-607140	6.4 0.25	214.1 8.43	1.5 0.06	326.1 12.84	77.38 170.63
EE350701	351687	X2S-350701	Y2S-351687	6.4 0.25	230.0 9.06	1.5 0.06	383.0 15.08	140.04 308.70
JM736149	JM736110	M736149XC	M736110ES	3.0 0.12	196.0 7.72	1.0 0.04	242.6 9.55	14.04 30.94
JM241538	JM241511		M241511EA	3.0 0.12	211.0 8.31	1.5 0.06	280.0 11.02	30.43 67.06
JM738249	JM738210	M738249XB	M738210ES	3.0 0.12	206.0 8.11	1.0 0.04	252.0 9.92	14.43 31.79
X32038XM	Y32038XM	K161907	K161906	3.0 0.12	214.0 8.43	1.0 0.04	281.0 11.06	31.16 68.69
HH840249	HH840210	HH840249XA	HH840210EB	6.4 0.25	234.0 9.21	1.5 0.06	318.0 12.52	73.98 163.10

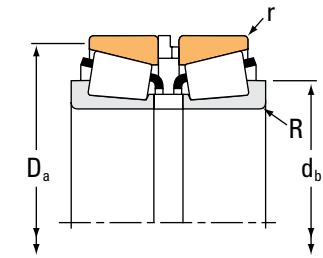
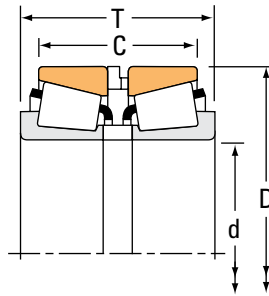
⁽⁵⁾Contact your Timken engineer for information on spacer configurations.

⁽⁶⁾These maximum fillet radii will be cleared by the bearing corners.

TAPERED ROLLER BEARINGS

DOUBLE-ROW • TYPE 2TS-IM

TYPE 2TS-IM



Bearing Dimensions				Load Ratings							
Bore d	O.D. D	Width ⁽¹⁾ T	Width C	Dynamic ⁽²⁾		Factors ⁽³⁾		Dynamic ⁽⁴⁾			Factors ⁽³⁾
mm in.	mm in.	mm in.	mm in.	C ₁₍₂₎	e	Y ₁	Y ₂	C ₉₀	C _{a90}	C ₉₀₍₂₎	K
N lbf	N lbf	N lbf	N lbf	N lbf	N lbf	N lbf	N lbf	N lbf	N lbf	N lbf	N lbf
190.500 7.5000	336.550 13.2500	209.550 8.2500	171.450 6.7500	1640000 370000	0.37	1.85	2.75	245000 55000	153000 34400	426000 95800	1.60
190.500 7.5000	428.625 16.8750	228.600 9.0000	139.700 5.5000	2860000 644000	0.76	0.89	1.33	426000 95900	554000 124000	742000 167000	0.77
196.850 7.7500	257.175 10.1250	139.700 5.5000	120.649 4.7500	554000 125000	0.45	1.51	2.25	82500 18600	63100 14200	144000 32300	1.31
200.000 7.8740	300.000 11.8110	141.000 5.5512	113.000 4.4488	1210000 272000	0.52	1.29	1.93	180000 40500	161000 36200	314000 70500	1.12
200.025 7.8750	333.375 13.1250	292.100 11.5000	257.175 10.1250	1600000 359000	0.44	1.54	2.29	238000 53400	179000 40200	414000 93000	1.33
203.200 8.0000	282.575 11.1250	101.600 4.0000	82.549 3.2500	875000 197000	0.51	1.33	1.97	130000 29300	114000 25500	227000 51000	1.15
203.200 8.0000	317.500 12.5000	146.050 5.7500	111.125 4.3750	1270000 286000	0.52	1.29	1.92	190000 42600	170000 38200	330000 74200	1.12
203.200 8.0000	482.600 19.0000	260.350 10.2500	171.450 6.7500	2870000 646000	0.87	0.78	1.16	428000 96200	635000 143000	745000 168000	0.67
206.375 8.1250	336.550 13.2500	298.450 11.7500	257.175 10.1250	2360000 530000	0.33	2.03	3.02	351000 79000	200000 45000	612000 137000	1.76
209.550 8.2500	317.500 12.5000	146.050 5.7500	111.125 4.3750	1270000 286000	0.52	1.29	1.92	190000 42600	170000 38200	330000 74200	1.12
215.900 8.5000	285.750 11.2500	138.074 5.4360	115.849 4.5610	748000 168000	0.48	1.40	2.09	111000 25000	91800 20600	194000 43600	1.21
220.000 8.6614	340.000 13.3858	165.000 6.4960	127.000 5.0000	1730000 389000	0.43	1.57	2.34	258000 57900	190000 42700	449000 101000	1.36
220.662 8.6875	314.325 12.3750	131.762 5.1875	106.362 4.1875	1210000 272000	0.33	2.03	3.02	180000 40500	103000 23100	314000 70500	1.76
228.600 9.0000	300.038 11.8125	76.200 3.0000	76.200 3.0000	414000 93000	0.40	1.68	2.50	61600 13900	42400 9530	107000 24100	1.45
228.600 9.0000	355.600 14.0000	254.000 10.0000	212.725 8.3750	1320000 297000	0.59	1.14	1.70	197000 44200	199000 44700	343000 77000	0.99
234.950 9.2500	384.175 15.1250	302.260 11.9000	257.810 10.1500	2920000 656000	0.33	2.03	3.02	434000 97600	247000 55600	756000 170000	1.76
241.300 9.5000	327.025 12.8750	114.300 4.5000	82.550 3.2500	918000 206000	0.41	1.66	2.47	137000 30700	95200 21400	238000 53500	1.44

⁽¹⁾Overall width can vary depending on spacer selection. Contact your Timken engineer for more information.

⁽²⁾Based on 1×10^6 revolutions L_{10} life, for the ISO life-calculation method. $C_{1(2)}$ is the double-row radial value.

⁽³⁾Consult your Timken engineer for instructions on use or review the Timken Engineering Manual on timken.com/catalogs.

⁽⁴⁾Based on 90×10^6 revolutions L_{10} life, for The Timken Company life-calculation method. C_{90} and C_{a90} are radial and thrust values for single-row.

$C_{90(2)}$ is the double-row radial value.

Part Number				Dimensions				Bearing Weight
Inner	Outer	Inner Spacer ⁽⁵⁾	Outer Spacer ⁽⁵⁾	Shaft		Housing		
				Max. Shaft Fillet Radius R ⁽⁶⁾	Backing Shoulder Dia. d _b	Max. Housing Fillet Radius r ⁽⁶⁾	Backing Shoulder Dia. D _a	
				mm in.	mm in.	mm in.	mm in.	kg lbs.
470975	470132	K161993	K161994	4.8 0.19	217.0 8.54	1.5 0.06	306.5 12.07	65.05 143.43
EE350750	351687	X3S-350750	Y2S-351687	6.4 0.25	240.0 9.45	1.5 0.06	383.0 15.08	134.55 296.63
LM739749	LM739710	LM739749XE	LM739710EA	3.5 0.14	213.0 8.39	0.8 0.03	251.0 9.88	17.23 38.00
JHM840449	JHM840410	HM840449XA	HM840410EA	3.5 0.14	226.0 8.90	1.5 0.06	288.9 11.37	32.47 71.60
HM743337	HM743310	HM743337XB		6.4 0.25	231.0 9.09	1.5 0.06	317.0 12.48	60.60 133.62
67983	67920	X2S-67983	Y10S-67920	3.5 0.14	222.0 8.74	0.8 0.03	275.0 10.83	18.49 40.80
93800	93125	X4S-93800	Y14S-93125	4.3 0.17	227.0 8.94	1.5 0.06	300.0 11.81	38.40 84.68
EE380080	380190	X1S-380081	Y1S-380190	6.4 0.25	280.0 11.02	1.5 0.06	428.5 16.87	208.60 459.85
H242649	H242610	K163370		3.3 0.13	231.0 9.09	1.5 0.06	318.0 12.51	71.34 157.29
93825	93125	X1S-93825		4.3 0.17	233.0 9.17	1.5 0.06	300.0 11.81	34.37 75.78
LM742749	LM742710	LM742749XE		3.5 0.14	233.0 9.17	0.8 0.03	279.0 10.98	17.11 37.69
X32044XM	Y32044XM	K165766	K165765	4.0 0.16	248.0 9.76	1.5 0.06	325.0 12.80	49.99 110.23
M244249	M244210	M244249XA	M244210ER	6.4 0.25	245.0 9.65	1.5 0.06	300.0 11.81	29.87 65.87
544090	544118	X1S-544090	Y3S-544118	3.5 0.14	244.0 9.61	0.8 0.03	287.0 11.30	12.22 26.90
96900	96140	X6S-96900	Y9S-96140	7.0 0.28	260.0 10.24	0.8 0.03	334.0 13.15	69.98 154.32
H247549	H247510	H247549XE	H247510EF	6.4 0.25	273.0 10.75	1.5 0.06	362.5 14.27	118.22 260.64
8578	8520	X1S-8578	Y7S-8520	6.4 0.25	264.0 10.39	0.8 0.03	313.0 12.32	23.66 52.19

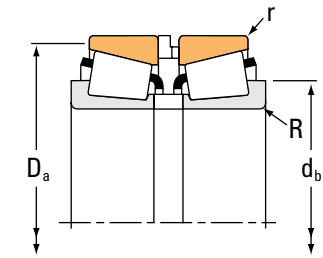
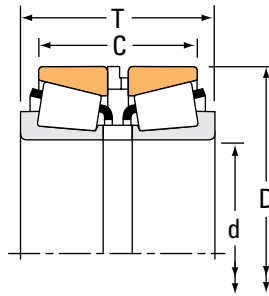
⁽⁵⁾Contact your Timken engineer for information on spacer configurations.

⁽⁶⁾These maximum fillet radii will be cleared by the bearing corners.

TAPERED ROLLER BEARINGS

DOUBLE-ROW • TYPE 2TS-IM

TYPE 2TS-IM



Bearing Dimensions				Load Ratings							
Bore d	O.D. D	Width ⁽¹⁾ T	Width C	Dynamic ⁽²⁾				Dynamic ⁽⁴⁾			
				C ₁₍₂₎	e	Factors ⁽³⁾ Y ₁	Y ₂	C ₉₀	C _{a90}	C ₉₀₍₂₎	Factors ⁽³⁾ K
mm in.	mm in.	mm in.	mm in.	N lbf				N lbf	N lbf	N lbf	
247.650 9.7500	406.400 16.0000	247.675 9.7510	203.225 8.0010	4290000 965000	0.33	2.03	3.02	639000 144000	364000 81800	1110000 250000	1.76
254.000 10.0000	358.775 14.1250	159.000 6.2598	124.074 4.8848	1450000 327000	0.33	2.03	3.02	217000 48700	123000 27700	377000 84800	1.76
257.175 10.1250	342.900 13.5000	215.900 8.5000	190.500 7.5000	1360000 305000	0.35	1.94	2.89	202000 45500	120000 27000	352000 79200	1.68
257.175 10.1250	358.775 14.1250	161.926 6.3750	127.000 5.0000	1450000 327000	0.33	2.03	3.02	217000 48700	123000 27700	377000 84800	1.76
266.700 10.5000	444.500 17.5000	266.700 10.5000	203.200 8.0000	3180000 714000	0.58	1.17	1.75	473000 106000	466000 105000	823000 185000	1.01
279.982 11.0229	380.009 14.9610	160.175 6.3061	128.425 5.0561	1260000 283000	0.43	1.56	2.33	187000 42100	138000 31100	326000 73300	1.35
288.925 11.3750	406.400 16.0000	165.100 6.5000	130.175 5.1250	2070000 466000	0.34	2.00	2.97	308000 69300	179000 40100	537000 121000	1.73
304.800 12.0000	406.400 16.0000	159.000 6.2598	127.250 5.0098	1340000 301000	0.44	1.53	2.28	199000 44800	151000 33900	347000 78100	1.32
317.500 12.5000	444.500 17.5000	146.050 5.7500	98.425 3.8750	1540000 347000	0.38	1.79	2.66	230000 51700	149000 33400	400000 90000	1.55
317.500 12.5000	622.300 24.5000	304.800 12.0000	174.625 6.8750	5500000 1240000	0.94	0.72	1.07	819000 184000	1310000 295000	1430000 321000	0.62
355.600 14.0000	444.500 17.5000	127.000 5.0000	101.600 4.0000	1280000 287000	0.31	2.20	3.27	190000 42700	100000 22500	331000 74400	1.90
355.600 14.0000	482.600 19.0000	133.350 5.2500	88.900 3.5000	1090000 246000	0.50	1.35	2.01	163000 36600	140000 31400	284000 63800	1.17
361.950 14.2500	406.400 16.0000	72.746 2.8640	60.046 2.3640	345000 77500	0.40	1.68	2.50	51300 11500	35300 7940	89400 20100	1.45
381.000 15.0000	479.425 18.8750	113.424 4.4655	84.850 3.3405	1030000 232000	0.50	1.36	2.03	154000 34600	130000 29300	268000 60300	1.18
406.400 16.0000	508.000 20.0000	174.884 6.8852	146.309 5.7602	1500000 336000	0.37	1.85	2.75	223000 50100	139000 31300	388000 87200	1.60
476.250 18.7500	565.150 22.2500	95.250 3.7500	76.200 3.0000	817000 184000	0.47	1.44	2.14	122000 27400	97800 22000	212000 47600	1.24
476.250 18.7500	565.150 22.2500	127.000 5.0000	107.950 4.2500	817000 184000	0.47	1.44	2.14	122000 27400	97800 22000	212000 47600	1.24

⁽¹⁾Overall width can vary depending on spacer selection. Contact your Timken engineer for more information.

⁽²⁾Based on 1×10^6 revolutions L_{10} life, for the ISO life-calculation method. $C_{1(2)}$ is the double-row radial value.

⁽³⁾Consult your Timken engineer for instructions on use or review the Timken Engineering Manual on timken.com/catalogs.

⁽⁴⁾Based on 90×10^6 revolutions L_{10} life, for The Timken Company life-calculation method. C_{90} and C_{a90} are radial and thrust values for single-row.

$C_{90(2)}$ is the double-row radial value.

Part Number				Dimensions				Bearing Weight
Inner	Outer	Inner Spacer ⁽⁵⁾	Outer Spacer ⁽⁵⁾	Shaft		Housing		
				Max. Shaft Fillet Radius	Backing Shoulder Dia.	Max. Housing Fillet Radius	Backing Shoulder Dia.	
				R ⁽⁶⁾	d _b	r ⁽⁶⁾	D _a	
				mm	mm	mm	mm	kg
				in.	in.	in.	in.	lbs.
HH249949H	HH249910	HH249949XA		6.4 0.25	288.0 11.34	1.5 0.06	383.0 15.08	121.91 268.77
M249749AH	M249710	M249749XS	M249710EW	1.5 0.06	270.0 10.63	1.5 0.06	343.0 13.50	45.20 99.68
M349549	M349510	M349549XA	M349510EA	6.4 0.25	281.0 11.06	0.8 0.03	333.0 13.11	43.51 95.91
M249747	M249710	M249747XB	M249710EX	1.5 0.06	272.0 10.71	1.5 0.06	343.0 13.50	43.67 96.26
H852849	H852810	H852849XA	H852810EA	6.4 0.25	315.0 12.40	1.5 0.06	422.3 16.63	153.67 338.81
LM654642	LM654611	LM654642XA	LM654611EA	3.5 0.14	302.0 11.89	1.5 0.06	368.0 14.49	47.07 103.76
M255449	M255410	M255449XB		6.4 0.25	316.0 12.44	1.5 0.06	387.9 15.27	62.37 137.51
LM757049	LM757010	LM757049XC	LM757010EC	6.4 0.25	331.0 13.03	1.5 0.06	393.0 15.47	50.93 112.26
EE291250	291750	X1S-291250	Y7S-291750	8.0 0.31	346.0 13.62	1.5 0.06	415.0 16.34	53.55 118.07
H961649	H961610	H961649XA	H961610EB	14.3 0.56	410.0 16.14	3.3 0.13	581.6 22.90	368.76 812.92
L163149	L163110	L163149XS	L163110EC	3.5 0.14	374.0 14.72	1.5 0.06	430.0 16.93	42.90 94.59
EE161400	161900	X1S-161400	Y9S-161900	7.0 0.28	386.0 15.20	1.5 0.06	455.0 17.91	54.23 119.54
LL562749	LL562710	LL562749XB	LL562710EB	2.3 0.09	372.0 14.65	0.8 0.03	401.0 15.79	10.25 22.58
L865547	L865512	L865547XA		6.4 0.25	407.0 16.02	1.5 0.06	465.0 18.31	38.54 84.95
L467549	L467510	K164387		3.3 0.13	426.0 16.77	1.5 0.06	492.0 19.37	58.69 129.41
LL771948	LL771911	LL771948XB	LL771911EC	3.3 0.13	495.0 19.49	1.5 0.06	549.0 21.61	42.74 94.22
LL771948	LL771911	LL771948XA	LL771911EB	3.3 0.13	495.0 19.49	1.5 0.06	549.0 21.61	51.17 112.81

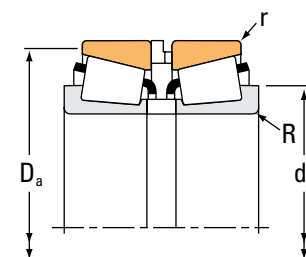
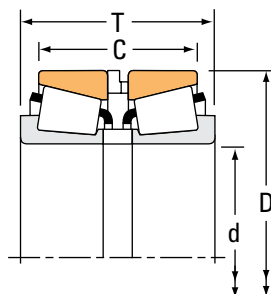
⁽⁵⁾Contact your Timken engineer for information on spacer configurations.

⁽⁶⁾These maximum fillet radii will be cleared by the bearing corners.

TAPERED ROLLER BEARINGS

DOUBLE-ROW • TYPE 2TS-IM

TYPE 2TS-IM



Bearing Dimensions				Load Ratings							
Bore d	O.D. D	Width ⁽¹⁾ T	Width C	Dynamic ⁽²⁾				Dynamic ⁽⁴⁾			
				C ₁₍₂₎	e	Factors ⁽³⁾ Y ₁	Y ₂	C ₉₀	C _{a90}	C ₉₀₍₂₎	Factors ⁽³⁾ K
mm in.	mm in.	mm in.	mm in.	N lbf				N lbf	N lbf	N lbf	
482.600 19.0000	615.950 24.2500	107.950 4.2500	82.550 3.2500	1140000 257000	0.35	1.93	2.88	170000 38200	102000 22900	296000 66600	1.67
488.950 19.2500	634.873 24.9950	209.990 8.2673	165.538 6.5173	3240000 728000	0.47	1.43	2.12	482000 108000	390000 87800	840000 189000	1.24
488.950 19.2500	634.873 24.9950	227.990 8.9760	183.540 7.2260	3240000 728000	0.47	1.43	2.12	482000 108000	390000 87800	840000 189000	1.24
539.750 21.2500	635.000 25.0000	120.650 4.7500	95.250 3.7500	1550000 349000	0.41	1.66	2.48	231000 52000	161000 36100	403000 90500	1.44
558.800 22.0000	736.600 29.0000	225.425 8.8875	177.800 7.0000	4980000 1120000	0.35	1.95	2.90	741000 167000	439000 98800	1290000 290000	1.69
584.200 23.0000	685.800 27.0000	107.950 4.2500	79.375 3.1250	1390000 312000	0.44	1.54	2.30	207000 46500	155000 34800	360000 81000	1.34
673.100 26.5000	793.750 31.2500	149.225 5.8750	114.299 4.5000	1930000 434000	0.36	1.87	2.79	287000 64600	177000 39800	500000 112000	1.62
736.600 29.0000	825.500 32.5000	114.300 4.5000	101.600 4.0000	738000 166000	0.40	1.70	2.53	110000 24700	74800 16800	191000 43000	1.47
762.000 30.0000	889.000 35.0000	158.100 6.2244	120.000 4.7244	2730000 613000	0.38	1.78	2.65	406000 91400	263000 59200	707000 159000	1.54
1155.700 45.5000	1435.100 56.5000	267.051 10.5138	216.251 8.5138	7030000 1580000	0.36	1.87	2.78	1050000 235000	647000 146000	1820000 410000	1.62
1562.100 61.5000	1806.575 71.1250	266.700 10.5000	184.150 7.2500	7900000 1780000	0.47	1.42	2.12	1180000 265000	955000 215000	2050000 461000	1.23

⁽¹⁾Overall width can vary depending on spacer selection. Contact your Timken engineer for more information.

⁽²⁾Based on 1×10^6 revolutions L_{10} life, for the ISO life-calculation method. $C_{1(2)}$ is the double-row radial value.

⁽³⁾Consult your Timken engineer for instructions on use or review the Timken Engineering Manual on timken.com/catalogs.

⁽⁴⁾Based on 90×10^6 revolutions L_{10} life, for The Timken Company life-calculation method. C_{90} and C_{a90} are radial and thrust values. $C_{90(2)}$ is the double-row radial value.

Part Number				Dimensions				Bearing Weight
Inner	Outer	Inner Spacer ⁽⁵⁾	Outer Spacer ⁽⁵⁾	Shaft		Housing		
				Max. Shaft Fillet Radius	Backing Shoulder Dia.	Max. Housing Fillet Radius	Backing Shoulder Dia.	
				R ⁽⁶⁾	d _b	r ⁽⁶⁾	D _a	
				mm	mm	mm	mm	kg
				in.	in.	in.	in.	lbs.
80480	80425	X3S-80480		3.3 0.13	504.0 19.84	1.5 0.06	579.0 22.80	71.57 157.75
LM772748	LM772710	LM772748XR		6.4 0.25	522.0 20.55	1.5 0.06	613.3 24.15	135.16 297.99
LM772748	LM772710	LM772748XS		6.4 0.25	522.0 20.55	1.5 0.06	613.3 24.15	137.63 303.43
LL575349	LL575310	LL575349XA	LL575310EA	6.4 0.25	564.0 22.20	1.5 0.06	621.0 24.45	55.46 122.28
LM377449H	LM377410	LM377449XB	K160687	6.4 0.25	594.0 23.39	1.5 0.06	708.0 27.87	238.25 525.26
LL778149	LL778110	LL778149XA	LL778110EA	3.5 0.14	603.0 23.74	0.8 0.03	669.0 26.34	60.96 134.38
LL481448	LL481411	LL481448XA	LL481411EB	6.4 0.25	702.0 27.64	1.5 0.06	771.0 30.35	113.30 249.80
LL582949	LL582910	K162749	K162748	3.5 0.14	753.1 29.65	1.5 0.06	822.0 32.36	55.89 123.17
LL483449	LL483418	LL483449XA	LL483418EA	3.3 0.13	783.0 30.83	1.5 0.06	858.0 33.78	146.64 323.31
EE277455	277565	X2S-277455	Y1S-277565	6.4 0.25	1205.0 47.44	3.3 0.13	1370.0 53.94	931.80 2054.23
EE299615	299711X	X2S-299615	Y3S-299711	9.7 0.38	1615.0 63.58	3.3 0.13	1757.5 69.19	994.87 2193.30

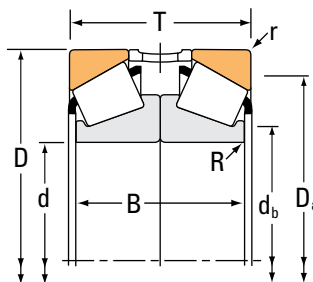
⁽⁵⁾ Contact your Timken engineer for information on spacer configurations.

⁽⁶⁾ These maximum fillet radii will be cleared by the bearing corners.

TAPERED ROLLER BEARINGS

DOUBLE-ROW • TYPE 2TS-DM

TYPE 2TS-DM



Bearing Dimensions				Load Ratings							
Bore d	O.D. D	Width ⁽¹⁾ T	Width B	Dynamic ⁽²⁾				Dynamic ⁽⁴⁾			
				C ₁₍₂₎	e	Factors ⁽³⁾ Y ₁	Y ₂	C ₉₀	C _{a90}	C ₉₀₍₂₎	Factors ⁽³⁾ K
mm in.	mm in.	mm in.	mm in.	N lbf				N lbf	N lbf	N lbf	
25.000 0.9843	52.000 2.0472	38.500 1.5158	36.000 1.4174	81800 18400	0.58	1.16	1.72	12200 2740	12200 2740	21200 4770	1.00
30.000 1.1811	55.000 2.1654	34.000 1.3386	34.000 1.3386	80900 18200	0.43	1.57	2.34	12000 2710	8870 1990	21000 4710	1.36
34.925 1.3750	65.088 2.5625	36.068 1.4200	36.576 1.4400	112000 25300	0.38	1.79	2.67	16700 3760	10800 2430	29200 6550	1.55
41.275 1.6250	80.167 3.1562	50.800 2.0000	50.800 2.0000	159000 35700	0.32	2.12	3.15	23600 5310	12900 2900	41100 9240	1.83
44.450 1.7500	82.931 3.2650	47.625 1.8750	50.800 2.0000	158000 35400	0.33	2.02	3.00	23500 5270	13500 3020	40900 9180	1.74
44.450 1.7500	88.900 3.5000	60.325 2.3750	58.740 2.3126	198000 44500	0.55	1.24	1.84	29500 6630	27600 6200	51300 11500	1.07
44.450 1.7500	95.250 3.7500	61.915 2.4376	57.150 2.2500	237000 53400	0.74	0.91	1.36	35400 7950	44800 10100	61600 13800	0.79
45.000 1.7717	100.000 3.9370	54.500 2.1457	50.000 1.9686	225000 50500	0.35	1.96	2.91	33500 7530	19800 4450	58300 13100	1.69
48.412 1.9060	95.250 3.7500	60.325 2.3750	58.740 2.3126	257000 57700	0.55	1.24	1.84	38200 8590	35700 8030	66600 15000	1.07
50.800 2.0000	88.900 3.5000	41.275 1.6250	44.450 1.7500	177000 39900	0.32	2.11	3.14	26400 5930	14400 3250	46000 10300	1.83
50.800 2.0000	112.712 4.4375	60.325 2.3750	60.096 2.3660	242000 54300	0.40	1.68	2.50	36000 8090	24800 5570	62700 14100	1.45
53.975 2.1250	95.250 3.7500	55.565 2.1876	57.150 2.2500	226000 50800	0.33	2.05	3.05	33600 7560	19000 4270	58600 13200	1.77
53.975 2.1250	104.775 4.1250	73.025 2.8750	73.024 2.8750	354000 79600	0.49	1.38	2.06	52700 11900	44000 9890	91800 20600	1.20
55.000 2.1654	90.000 3.5433	46.000 1.8110	46.000 1.8110	190000 42600	0.40	1.68	2.50	28200 6340	19400 4370	49100 11000	1.45
55.000 2.1654	120.000 4.7244	58.000 2.2835	58.000 2.2834	299000 67300	0.83	0.82	1.22	44600 10000	63000 14200	77600 17500	0.71
55.562 2.1875	97.630 3.8437	49.215 1.9376	49.216 1.9376	215000 48200	0.40	1.68	2.50	32000 7180	22000 4950	55600 12500	1.45
57.150 2.2500	96.838 3.8125	42.001 1.6536	43.892 1.7280	188000 42200	0.35	1.91	2.84	28000 6280	16900 3810	48700 10900	1.65

⁽¹⁾Overall width can vary depending on spacer selection. Contact your Timken engineer for more information.

⁽²⁾Based on 1×10^6 revolutions L_{10} life, for the ISO life-calculation method. $C_{1(2)}$ is the double-row radial value.

⁽³⁾Consult your Timken engineer for instructions on use or review the Timken Engineering Manual on timken.com/catalogs.

⁽⁴⁾Based on 90×10^6 revolutions L_{10} life, for The Timken Company life-calculation method. C_{90} and C_{a90} are radial and thrust values. $C_{90(2)}$ is the double-row radial value.

Part Number			Dimensions				Bearing Weight
Inner	Outer	Outer Spacer ⁽⁵⁾	Shaft		Housing		
			Max. Shaft Fillet Radius R ⁽⁶⁾	Backing Shoulder Dia. d _b	Max. Housing Fillet Radius r ⁽⁶⁾	Max. Backing Shoulder Dia. D _a	
			mm in.	mm in.	mm in.	mm in.	kg lbs.
X32205-B	Y32205-B	JY5209R	0.3 0.01	31.0 1.22	1.0 0.04	43.5 1.71	0.40 0.88
X32006X	Y32006X	JY5508-S	0.3 0.01	36.0 1.42	1.0 0.04	49.0 1.93	0.37 0.79
LM48548	LM48510	LM48510EE	0.4 0.02	41.5 1.63	1.3 0.05	58.0 2.28	0.52 1.12
26885	26820	Y1S-26820	0.3 0.01	47.0 1.85	3.3 0.13	69.0 2.72	1.15 2.57
25580	25520	Y4S-25520	0.4 0.02	50.0 1.97	0.8 0.03	74.0 2.91	1.18 2.58
HM803149	HM803110	HM803110EB	0.3 0.01	53.4 2.10	3.3 0.13	74.0 2.91	1.76 3.88
HM903249	HM903210	HM903210ES	0.3 0.01	54.0 2.13	0.8 0.03	81.0 3.19	2.08 4.60
X30309M	Y30309M	JY10099R	0.5 0.02	56.0 2.20	1.5 0.06	89.0 3.50	2.11 4.64
HM804848	HM804810	HM804810EE	2.3 0.09	57.0 2.26	3.3 0.13	81.0 3.19	1.99 4.42
368A	362A	Y1S-362A	0.3 0.01	56.0 2.20	1.3 0.05	81.0 3.19	1.08 2.34
3975	3920	Y4S-3920	0.5 0.02	61.0 2.40	3.3 0.13	99.0 3.90	3.13 6.91
33895	33821	Y1S-33821	0.3 0.01	60.0 2.36	2.3 0.09	85.0 3.35	1.66 3.66
HM807049	HM807010	HM807010EE	0.3 0.01	63.1 2.48	3.3 0.13	89.0 3.50	2.88 6.35
JLM506849	JLM506810	LM506810EX	0.3 0.01	61.0 2.40	0.5 0.02	82.0 3.23	1.12 2.50
X31311M	Y31311M	JY12021-Q	0.3 0.01	68.0 2.68	2.0 0.08	103.0 4.06	3.27 7.21
28680	28622	Y4S-28622	0.5 0.02	62.0 2.44	0.8 0.03	88.0 3.46	1.57 3.47
387A	382A	Y1S-382A	0.3 0.01	63.0 2.48	0.8 0.03	89.0 3.50	1.24 2.72

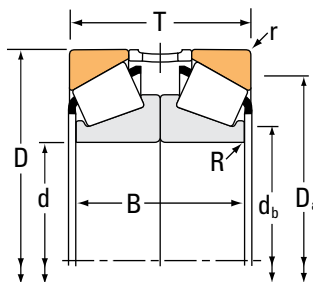
⁽⁵⁾Contact your Timken engineer for information on spacer configurations.

⁽⁶⁾These maximum fillet radii will be cleared by the bearing corners.

TAPERED ROLLER BEARINGS

DOUBLE-ROW • TYPE 2TS-DM

TYPE 2TS-DM



Bearing Dimensions				Load Ratings							
Bore d	O.D. D	Width ⁽¹⁾ T	Width B	Dynamic ⁽²⁾		Factors ⁽³⁾		Dynamic ⁽⁴⁾			Factors ⁽³⁾
				C ₁₍₂₎	e	Y ₁	Y ₂	C ₉₀	C _{a90}	C ₉₀₍₂₎	K
mm in.	mm in.	mm in.	mm in.	N lbf				N lbf	N lbf	N lbf	
57.150 2.2500	112.712 4.4375	60.325 2.3750	60.096 2.3660	242000 54300	0.40	1.68	2.50	36000 8090	24800 5570	62700 14100	1.45
60.000 2.3622	112.712 4.4375	60.325 2.3750	60.096 2.3660	242000 54300	0.40	1.68	2.50	36000 8090	24800 5570	62700 14100	1.45
60.325 2.3750	100.000 3.9370	50.800 2.0000	50.800 2.0000	185000 41500	0.43	1.59	2.36	27500 6180	20000 4500	47900 10800	1.37
60.325 2.3750	112.712 4.4375	60.325 2.3750	60.096 2.3660	242000 54300	0.40	1.68	2.50	36000 8090	24800 5570	62700 14100	1.45
60.325 2.3750	130.175 5.1250	73.025 2.8750	66.676 2.6250	344000 77400	0.82	0.82	1.23	51200 11500	71900 16200	89200 20100	0.71
61.912 2.4375	123.825 4.8750	76.200 3.0000	73.356 2.8880	332000 74700	0.35	1.95	2.90	49400 11100	29300 6590	86100 19400	1.69
61.912 2.4375	146.050 5.7500	82.550 3.2500	79.376 3.1250	474000 107000	0.78	0.86	1.28	70700 15900	94700 21300	123000 27700	0.75
61.912 2.4375	152.400 6.0000	95.250 3.7500	92.076 3.6250	497000 112000	0.66	1.03	1.53	74000 16600	83100 18700	129000 29000	0.89
63.500 2.5000	112.712 4.4375	60.325 2.3750	60.096 2.3660	242000 54300	0.40	1.68	2.50	36000 8090	24800 5570	62700 14100	1.45
63.500 2.5000	122.238 4.8125	76.200 3.0000	76.708 3.0200	465000 104000	0.34	2.00	2.98	69200 15600	40000 8990	121000 27100	1.73
63.500 2.5000	140.030 5.5130	73.025 2.8750	66.472 2.6170	353000 79300	0.87	0.78	1.16	52600 11800	77900 17500	91500 20600	0.67
65.000 2.5591	105.000 4.1339	48.000 1.8898	46.000 1.8110	223000 50200	0.45	1.49	2.21	33200 7470	25800 5810	57900 13000	1.29
65.000 2.5591	110.000 4.3307	56.000 2.2047	56.000 2.2048	291000 65400	0.40	1.68	2.50	43300 9740	29800 6700	75400 17000	1.45
65.087 2.5625	135.755 5.3447	107.950 4.2500	112.014 4.4100	663000 149000	0.32	2.08	3.10	98800 22200	54900 12300	172000 38700	1.80
66.675 2.6250	112.712 4.4375	60.325 2.3750	60.324 2.3750	291000 65300	0.34	1.99	2.96	43300 9730	25100 5650	75400 16900	1.72
66.675 2.6250	122.238 4.8125	76.200 3.0000	76.708 3.0200	465000 104000	0.34	2.00	2.98	69200 15600	40000 8990	121000 27100	1.73
66.675 2.6250	177.800 7.0000	114.300 4.5000	107.950 4.2500	785000 176000	0.80	0.85	1.26	117000 26300	160000 35900	203000 45700	0.73

⁽¹⁾Overall width can vary depending on spacer selection. Contact your Timken engineer for more information.

⁽²⁾Based on 1×10^6 revolutions L_{10} life, for the ISO life-calculation method. $C_{1(2)}$ is the double-row radial value.

⁽³⁾Consult your Timken engineer for instructions on use or review the Timken Engineering Manual on timken.com/catalogs.

⁽⁴⁾Based on 90×10^6 revolutions L_{10} life, for The Timken Company life-calculation method. C_{90} and C_{a90} are radial and thrust values. $C_{90(2)}$ is the double-row radial value.

Part Number			Dimensions				Bearing Weight
Inner	Outer	Outer Spacer ⁽⁵⁾	Shaft		Housing		
			Max. Shaft Fillet Radius R ⁽⁶⁾	Backing Shoulder Dia. d _b	Max. Housing Fillet Radius r ⁽⁶⁾	Max. Backing Shoulder Dia. D _a	
			mm in.	mm in.	mm in.	mm in.	kg lbs.
3979	3920	Y4S-3920	0.5 0.02	66.0 2.60	3.3 0.13	99.0 3.90	2.87 6.35
3977	3920	Y4S-3920	0.5 0.02	68.0 2.68	3.3 0.13	99.0 3.90	2.75 6.07
28985	28921	Y1S-28921	0.3 0.01	67.0 2.64	3.3 0.13	89.0 3.50	1.55 3.45
3980	3920	Y3S-3920	0.5 0.02	68.0 2.68	3.3 0.13	99.0 3.90	2.74 6.06
HM911245	HM911210	HM911210EC	0.8 0.03	74.0 2.91	3.3 0.13	109.0 4.29	4.37 9.65
554	552A	Y3S-552A	0.5 0.02	71.0 2.80	3.3 0.13	109.0 4.29	4.23 9.35
H913842	H913810	H913810EA	0.8 0.03	82.4 3.24	3.3 0.13	124.0 4.88	6.65 14.67
9181	9121	Y1S-9121	0.5 0.02	81.3 3.20	3.3 0.13	130.0 5.12	8.35 18.42
3982	3920	Y3S-3920	0.3 0.01	71.0 2.80	3.3 0.13	99.0 3.90	2.60 5.74
HM212047	HM212011	HM212011EA	0.5 0.02	73.0 2.87	3.3 0.13	108.0 4.25	4.02 8.83
78250	78551	Y2S-78551	0.5 0.02	79.0 3.10	2.3 0.09	117.0 4.61	5.23 11.55
JLM710949C	JLM710910	JY10511-Q	0.3 0.01	72.0 2.83	1.0 0.04	96.0 3.78	1.58 3.45
JM511946	JM511910	JY11011-Q	0.3 0.01	72.0 2.83	2.5 0.10	99.0 3.90	2.19 4.82
6379	6320	Y3S-6320	0.3 0.01	77.0 3.04	3.3 0.13	117.0 4.61	7.50 16.56
39590	39520	Y1S-39520	0.3 0.01	75.0 2.95	3.3 0.13	101.0 3.98	2.41 5.31
HM212049	HM212011	HM212010EA	0.3 0.01	75.5 2.97	3.3 0.13	108.0 4.25	3.88 8.54
HH914449	HH914412	HH914412EA	1.5 0.06	85.3 3.36	3.3 0.13	146.0 5.75	14.54 32.03

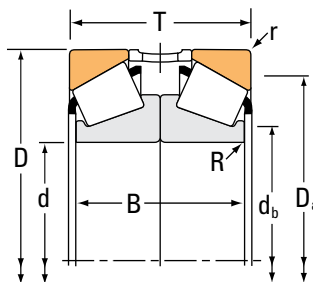
⁽⁵⁾Contact your Timken engineer for information on spacer configurations.

⁽⁶⁾These maximum fillet radii will be cleared by the bearing corners.

TAPERED ROLLER BEARINGS

DOUBLE-ROW • TYPE 2TS-DM

TYPE 2TS-DM



Bearing Dimensions				Load Ratings							
Bore d	O.D. D	Width ⁽¹⁾ T	Width B	Dynamic ⁽²⁾				Dynamic ⁽⁴⁾			
				C ₁₍₂₎	e	Factors ⁽³⁾ Y ₁	Y ₂	C ₉₀	C _{a90}	C ₉₀₍₂₎	Factors ⁽³⁾ K
mm in.	mm in.	mm in.	mm in.	N lbf				N lbf	N lbf	N lbf	
68.262 2.6875	161.925 6.3750	98.425 3.8750	92.076 3.6250	614000 138000	0.71	0.95	1.42	91400 20600	111000 24900	159000 35800	0.82
69.850 2.7500	120.000 4.7244	65.090 2.5626	65.090 2.5626	311000 70000	0.36	1.87	2.79	46300 10400	28600 6420	80700 18100	1.62
69.850 2.7500	127.000 5.0000	73.025 2.8750	73.024 2.8750	399000 89700	0.50	1.34	2.00	59400 13400	51100 11500	103000 23300	1.16
69.850 2.7500	146.050 5.7500	82.550 3.2500	79.376 3.1250	474000 107000	0.78	0.86	1.28	70700 15900	94700 21300	123000 27700	0.75
69.850 2.7500	146.050 5.7500	82.550 3.2500	82.550 3.2500	430000 96700	0.41	1.65	2.46	64000 14400	44800 10100	112000 25100	1.43
69.987 2.7554	136.525 5.3750	92.076 3.6250	92.076 3.6250	556000 125000	0.47	1.43	2.12	82700 18600	67000 15100	144000 32400	1.24
71.437 2.8125	136.525 5.3750	82.550 3.2500	82.550 3.2500	562000 126000	0.36	1.87	2.79	83700 18800	51600 11600	146000 32800	1.62
73.025 2.8750	117.475 4.6250	60.325 2.3750	60.324 2.3750	241000 54200	0.44	1.55	2.31	35900 8060	26800 6020	62400 14000	1.34
75.000 2.9528	115.000 4.5276	50.000 1.9686	50.000 1.9686	244000 54900	0.46	1.47	2.19	36400 8180	28600 6420	63400 14200	1.27
75.000 2.9528	125.000 4.9213	74.000 2.9134	74.000 2.9134	356000 80000	0.40	1.70	2.53	53000 11900	36100 8110	92300 20800	1.47
76.200 3.0000	121.442 4.7812	49.215 1.9376	46.024 1.8120	178000 40000	0.45	1.50	2.23	26500 5960	20500 4600	46100 10400	1.30
76.200 3.0000	127.000 5.0000	60.325 2.3750	62.000 2.4410	280000 63100	0.42	1.61	2.40	41800 9390	29900 6730	72700 16300	1.39
76.200 3.0000	135.733 5.3438	88.900 3.5000	92.200 3.6300	527000 118000	0.41	1.66	2.47	78500 17600	54600 12300	137000 30700	1.44
76.200 3.0000	136.525 5.3750	60.325 2.3750	59.538 2.3440	269000 60500	0.44	1.52	2.26	40000 9000	30500 6850	69700 15700	1.31
76.200 3.0000	139.992 5.5115	73.025 2.8750	72.196 2.8424	360000 80900	0.40	1.67	2.49	53600 12100	37100 8330	93400 21000	1.45
76.200 3.0000	146.050 5.7500	82.550 3.2500	82.550 3.2500	430000 96700	0.41	1.65	2.46	64000 14400	44800 10100	112000 25100	1.43
76.200 3.0000	152.400 6.0000	79.375 3.1250	72.644 2.8600	376000 84600	0.44	1.53	2.27	56000 12600	42400 9530	97500 21900	1.32

⁽¹⁾Overall width can vary depending on spacer selection. Contact your Timken engineer for more information.

⁽²⁾Based on 1×10^6 revolutions L_{10} life, for the ISO life-calculation method. $C_{1(2)}$ is the double-row radial value.

⁽³⁾Consult your Timken engineer for instructions on use or review the Timken Engineering Manual on timken.com/catalogs.

⁽⁴⁾Based on 90×10^6 revolutions L_{10} life, for The Timken Company life-calculation method. C_{90} and C_{a90} are radial and thrust values. $C_{90(2)}$ is the double-row radial value.

Part Number			Dimensions				Bearing Weight
Inner	Outer	Outer Spacer ⁽⁵⁾	Shaft		Housing		
			Max. Shaft Fillet Radius R ⁽⁶⁾	Backing Shoulder Dia. d _b	Max. Housing Fillet Radius r ⁽⁶⁾	Max. Backing Shoulder Dia. D _a	
			mm in.	mm in.	mm in.	mm in.	kg lbs.
9278	9220	Y1S-9220	0.5 0.02	89.0 3.50	3.3 0.13	138.0 5.43	9.34 20.59
47487	47420	Y1S-47420	0.5 0.02	78.0 3.07	3.3 0.13	107.0 4.21	3.03 6.66
HM813846	HM813810	HM813810EB	0.3 0.01	82.0 3.23	3.3 0.13	111.0 4.37	3.98 8.78
H913849	H913810	H913810EA	0.8 0.03	82.4 3.24	3.3 0.13	124.0 4.88	6.13 13.54
655	653	Y1S-653	0.5 0.02	82.0 3.23	3.3 0.13	131.0 5.16	6.67 14.70
H715347	H715311	H715311EE	0.5 0.02	87.0 3.43	3.3 0.13	118.0 4.65	6.48 14.29
H414249	H414210	H414210EA	1.5 0.06	83.3 3.27	3.3 0.13	121.0 4.76	5.26 11.63
33287	33462	Y5S-33462	0.3 0.01	81.0 3.19	3.3 0.13	104.0 4.09	2.47 5.43
JLM714149	JLM714110	M612910EA	0.3 0.01	82.0 3.23	2.5 0.10	104.0 4.09	1.84 4.05
X33115	Y33115	K161389	0.3 0.01	83.0 3.27	1.5 0.06	112.0 4.41	3.61 7.94
34301	34478	Y4S-34478	0.5 0.02	83.0 3.27	2.0 0.08	110.0 4.33	2.02 4.47
42687	42620	Y3S-42620	0.5 0.02	84.0 3.31	3.3 0.13	114.0 4.49	2.99 6.60
5760	5735	Y2S-5735	0.5 0.02	88.0 3.46	3.3 0.13	119.0 4.69	5.55 12.23
495A	493	Y3S-493	0.5 0.02	86.0 3.39	3.3 0.13	122.0 4.80	3.84 8.43
575	572	Y4S-572	0.5 0.02	86.0 3.39	3.3 0.13	125.0 4.92	4.94 10.93
659	653	Y1S-653	0.5 0.02	87.0 3.43	3.3 0.13	131.0 5.16	6.21 13.66
590A	592A	Y4S-592A	0.5 0.02	89.0 3.50	3.3 0.13	135.0 5.31	6.75 14.88

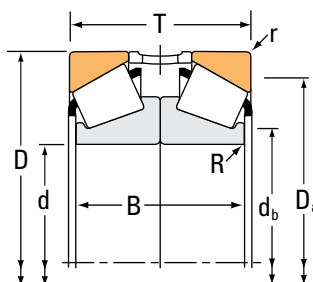
⁽⁵⁾Contact your Timken engineer for information on spacer configurations.

⁽⁶⁾These maximum fillet radii will be cleared by the bearing corners.

TAPERED ROLLER BEARINGS

DOUBLE-ROW • TYPE 2TS-DM

TYPE 2TS-DM



Bearing Dimensions				Load Ratings							
Bore d	O.D. D	Width ⁽¹⁾ T	Width B	Dynamic ⁽²⁾				Dynamic ⁽⁴⁾			
				C ₁₍₂₎	e	Factors ⁽³⁾ Y ₁	Y ₂	C ₉₀	C _{a90}	C ₉₀₍₂₎	Factors ⁽³⁾ K
mm in.	mm in.	mm in.	mm in.	N lbf				N lbf	N lbf	N lbf	
76.200 3.0000	161.925 6.3750	95.250 3.7500	96.520 3.8000	570000 128000	0.34	1.98	2.95	84800 19100	49500 11100	148000 33200	1.71
76.200 3.0000	161.925 6.3750	98.425 3.8750	92.076 3.6250	614000 138000	0.71	0.95	1.42	91400 20600	111000 24900	159000 35800	0.82
76.200 3.0000	171.450 6.7500	98.425 3.8750	92.076 3.6250	632000 142000	0.76	0.88	1.31	94100 21200	123000 27700	164000 36800	0.76
77.788 3.0625	117.475 4.6250	50.800 2.0000	50.800 2.0000	205000 46100	0.51	1.32	1.97	30600 6870	26700 5990	53200 12000	1.15
80.000 3.1496	130.000 5.1181	70.000 2.7559	68.000 2.6772	410000 92100	0.39	1.74	2.59	61000 13700	40600 9120	106000 23900	1.50
80.962 3.1875	136.525 5.3750	60.325 2.3750	59.538 2.3440	269000 60500	0.44	1.52	2.26	40000 9000	30500 6850	69700 15700	1.31
82.550 3.2500	133.350 5.2500	79.375 3.1250	79.376 3.1250	450000 101000	0.40	1.68	2.50	67100 15100	46200 10400	117000 26300	1.45
82.550 3.2500	161.925 6.3750	107.950 4.2500	110.200 4.3386	765000 172000	0.40	1.69	2.51	114000 25600	78100 17600	198000 44600	1.46
83.345 3.2813	125.412 4.9375	50.800 2.0000	50.800 2.0000	204000 45900	0.42	1.62	2.42	30400 6830	21600 4860	52900 11900	1.40
84.138 3.3125	171.450 6.7500	98.425 3.8750	92.076 3.6250	632000 142000	0.76	0.88	1.31	94100 21200	123000 27700	164000 36800	0.76
85.000 3.3465	130.000 5.1181	60.000 2.3622	58.000 2.2834	281000 63100	0.44	1.52	2.26	41800 9400	31800 7150	72800 16400	1.31
85.000 3.3465	150.000 5.9055	92.000 3.6220	92.000 3.6220	685000 154000	0.33	2.03	3.02	102000 22900	58100 13100	178000 39900	1.76
88.900 3.5000	161.925 6.3750	107.950 4.2500	110.200 4.3386	765000 172000	0.40	1.69	2.51	114000 25600	78100 17600	198000 44600	1.46
88.900 3.5000	200.000 7.8740	105.522 4.1544	98.424 3.8750	839000 189000	0.63	1.07	1.59	125000 28100	135000 30400	217000 48900	0.92
89.975 3.5423	146.975 5.7864	80.000 3.1496	80.000 3.1496	565000 127000	0.33	2.03	3.02	84200 18900	47900 10800	147000 33000	1.76
90.000 3.5433	140.000 5.5118	64.000 2.5197	64.000 2.5196	378000 85000	0.42	1.60	2.38	56300 12700	40800 9170	98000 22000	1.38
90.000 3.5433	145.000 5.7087	70.000 2.7559	68.000 2.6772	387000 87000	0.44	1.52	2.26	57700 13000	43900 9860	100000 22600	1.31

⁽¹⁾Overall width can vary depending on spacer selection. Contact your Timken engineer for more information.

⁽²⁾Based on 1 x 10⁶ revolutions L₁₀ life, for the ISO life-calculation method. C₁₍₂₎ is the double-row radial value.

⁽³⁾Consult your Timken engineer for instructions on use or review the Timken Engineering Manual on timken.com/catalogs.

⁽⁴⁾Based on 90 x 10⁶ revolutions L₁₀ life, for The Timken Company life-calculation method. C₉₀ and C_{a90} are radial and thrust values. C₉₀₍₂₎ is the double-row radial value.

Part Number			Dimensions				Bearing Weight
Inner	Outer	Outer Spacer ⁽⁵⁾	Shaft		Housing		
			Max. Shaft Fillet Radius R ⁽⁶⁾	Backing Shoulder Dia. d _b	Max. Housing Fillet Radius r ⁽⁶⁾	Max. Backing Shoulder Dia. D _a	
			mm in.	mm in.	mm in.	mm in.	kg lbs.
755	752	Y8S-752	0.5 0.02	92.0 3.62	3.3 0.13	144.0 5.67	9.92 21.86
9285	9220	Y1S-9220	0.5 0.02	89.0 3.50	3.3 0.13	138.0 5.43	8.68 19.16
9380	9321	Y1S-9321	0.5 0.02	98.2 3.87	3.3 0.13	147.0 5.79	10.71 23.59
LM814849	LM814810	LM814810EA	0.3 0.01	85.0 3.35	3.3 0.13	105.0 4.13	1.90 4.16
JM515649	JM515610	JY13013-Q	0.3 0.01	88.0 3.46	2.5 0.10	117.0 4.61	3.52 7.78
496	493	Y4S-493	0.5 0.02	89.0 3.50	3.3 0.13	122.0 4.80	3.50 7.69
HM516449C	HM516410	HM516410EA	0.3 0.01	92.0 3.62	3.3 0.13	118.0 4.65	4.41 9.74
6559C	6536	Y2S-6535	0.5 0.02	98.0 3.86	0.8 0.03	144.0 5.67	10.45 23.07
27690	27620	Y2S-27620	0.3 0.01	89.0 3.50	1.5 0.06	115.0 4.53	2.21 4.83
9386H	9321	Y9S-9321	0.5 0.02	98.3 3.87	3.3 0.13	147.0 5.79	9.83 21.66
JM716649	JM716610	M716610EB	0.3 0.01	92.0 3.62	2.5 0.10	117.0 4.61	2.80 6.19
JH217249	JH217210	H217210EA	0.5 0.02	95.0 3.74	2.5 0.10	134.0 5.28	6.90 15.20
6580	6535	Y2S-6535	0.5 0.02	102.0 4.02	3.3 0.13	141.0 5.55	9.71 21.42
98350	98788	Y3S-98788	0.8 0.03	112.0 4.41	3.3 0.13	174.0 6.85	16.18 35.66
HM218248	HM218210	HM218210EA	0.3 0.01	99.0 3.90	3.5 0.14	133.0 5.24	5.19 11.44
X32018X	Y32018X	JY14016-Q	0.3 0.01	98.0 3.86	1.5 0.06	128.0 5.04	3.54 7.79
JM718149	JM718110	JY14516-S	0.8 0.03	99.0 3.90	2.5 0.10	131.0 5.16	4.46 9.82

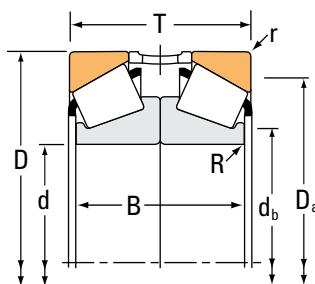
⁽⁵⁾Contact your Timken engineer for information on spacer configurations.

⁽⁶⁾These maximum fillet radii will be cleared by the bearing corners.

TAPERED ROLLER BEARINGS

DOUBLE-ROW • TYPE 2TS-DM

TYPE 2TS-DM



Bearing Dimensions				Load Ratings							
Bore d	O.D. D	Width ⁽¹⁾ T	Width B	Dynamic ⁽²⁾				Dynamic ⁽⁴⁾			
				C ₁₍₂₎	e	Factors ⁽³⁾ Y ₁	Y ₂	C ₉₀	C _{a90}	C ₉₀₍₂₎	Factors ⁽³⁾ K
mm in.	mm in.	mm in.	mm in.	N lbf				N lbf	N lbf	N lbf	
90.000 3.5433	155.000 6.1024	88.000 3.4646	88.000 3.4646	683000 153000	0.34	1.98	2.95	102000 22900	59400 13300	177000 39800	1.71
90.000 3.5433	190.000 7.4803	101.600 4.0000	92.076 3.6250	667000 150000	0.87	0.78	1.16	99300 22300	147000 33100	173000 38900	0.67
95.000 3.7402	150.000 5.9055	70.000 2.7559	68.000 2.6772	374000 84000	0.44	1.53	2.27	55700 12500	42100 9470	96900 21800	1.32
95.250 3.7500	147.638 5.8125	71.435 2.8124	72.644 2.8600	376000 84600	0.44	1.53	2.27	56000 12600	42400 9530	97500 21900	1.32
95.250 3.7500	168.275 6.6250	82.550 3.2500	82.550 3.2500	461000 104000	0.47	1.43	2.14	68600 15400	55300 12400	119000 26900	1.24
96.838 3.8125	148.430 5.8437	57.150 2.2500	57.942 2.2812	336000 75600	0.49	1.37	2.04	50100 11300	42200 9480	87100 19600	1.19
96.838 3.8125	188.912 7.4375	101.600 4.0000	92.076 3.6250	667000 150000	0.87	0.78	1.16	99300 22300	147000 33100	173000 38900	0.67
98.425 3.8750	168.275 6.6250	82.550 3.2500	82.550 3.2500	461000 104000	0.47	1.43	2.14	68600 15400	55300 12400	119000 26900	1.24
98.425 3.8750	184.150 7.2500	127.000 5.0000	127.000 5.0000	1090000 246000	0.37	1.80	2.69	163000 36600	104000 23500	284000 63800	1.56
99.212 3.9060	171.450 6.7500	98.425 3.8750	98.424 3.8750	602000 135000	0.34	1.97	2.93	89600 20100	52600 11800	156000 35100	1.70
100.000 3.9370	155.000 6.1024	72.000 2.8346	70.000 2.7560	403000 90600	0.47	1.43	2.12	60000 13500	48600 10900	104000 23500	1.24
100.000 3.9370	155.000 6.1024	72.481 2.8536	70.000 2.7560	403000 90600	0.47	1.43	2.12	60000 13500	48600 10900	104000 23500	1.24
100.000 3.9370	160.000 6.2992	82.000 3.2284	80.000 3.1496	576000 130000	0.47	1.43	2.14	85800 19300	69100 15500	149000 33600	1.24
100.000 3.9370	180.000 7.0866	74.000 2.9134	68.000 2.6772	524000 118000	0.42	1.61	2.39	78000 17500	56100 12600	136000 30500	1.39
101.600 4.0000	168.275 6.6250	82.550 3.2500	82.550 3.2500	461000 104000	0.47	1.43	2.14	68600 15400	55300 12400	119000 26900	1.24
101.600 4.0000	212.725 8.3750	133.350 5.2500	133.350 5.2500	996000 224000	0.33	2.07	3.09	148000 33300	82700 18600	258000 58000	1.79
101.600 4.0000	250.825 9.8750	152.400 6.0000	146.050 5.7500	1440000 324000	0.70	0.97	1.44	215000 48200	257000 57800	374000 84000	0.84

⁽¹⁾Overall width can vary depending on spacer selection. Contact your Timken engineer for more information.

⁽²⁾Based on 1×10^6 revolutions L_{10} life, for the ISO life-calculation method. $C_{1(2)}$ is the double-row radial value.

⁽³⁾Consult your Timken engineer for instructions on use or review the Timken Engineering Manual on timken.com/catalogs.

⁽⁴⁾Based on 90×10^6 revolutions L_{10} life, for The Timken Company life-calculation method. C_{90} and C_{a90} are radial and thrust values. $C_{90(2)}$ is the double-row radial value.

Part Number			Dimensions				Bearing Weight
Inner	Outer	Outer Spacer ⁽⁵⁾	Shaft		Housing		
			Max. Shaft Fillet Radius R ⁽⁶⁾	Backing Shoulder Dia. d _b	Max. Housing Fillet Radius r ⁽⁶⁾	Max. Backing Shoulder Dia. D _a	
			mm in.	mm in.	mm in.	mm in.	kg lbs.
JHM318448	JHM318410	HM318410EA	0.5 0.02	100.0 3.94	2.5 0.10	140.0 5.51	6.84 15.04
J90354	J90748	Y1S-90748	1.5 0.06	111.8 4.40	3.3 0.13	162.0 6.38	12.61 27.82
JM719149	JM719113	H217210EA	0.3 0.01	104.0 4.09	2.5 0.10	135.0 5.31	4.51 9.97
594	592XS	Y1S-592XS	0.3 0.01	104.0 4.09	3.3 0.13	133.0 5.24	4.31 9.51
683	672	Y6S-672	0.5 0.02	106.0 4.17	3.3 0.13	149.0 5.87	7.81 17.21
42381	42584	Y3S-42584	0.3 0.01	105.0 4.13	3.0 0.12	134.0 5.28	3.53 7.80
90381	90744	Y2S-90744	1.5 0.06	113.0 4.44	3.3 0.13	161.0 6.34	11.77 25.95
685	672	Y13S-672	0.5 0.02	109.0 4.29	3.3 0.13	149.0 5.87	7.58 16.67
HH421246C	HH421210	HH421210EB	1.5 0.06	115.1 4.53	3.3 0.13	163.0 6.42	15.24 33.63
HM321245	HM321210	HM321210EB	0.5 0.02	109.0 4.29	3.3 0.13	155.0 6.10	9.22 20.33
JM720249	JM720210	JY15516-Q	0.3 0.01	109.0 4.29	2.5 0.10	140.0 5.51	4.89 10.76
JM720249	JM720210	M720210EB	0.3 0.01	109.0 4.29	2.5 0.10	140.0 5.51	4.90 10.80
JHM720249	JHM720210	JY16018R	0.3 0.01	109.4 4.30	2.5 0.10	143.0 5.63	6.25 13.78
X30220M	Y30220M	JY18016-Q	1.0 0.04	115.0 4.53	2.5 0.10	163.0 6.42	7.87 17.35
687	672	Y6S-672	0.5 0.02	112.0 4.41	3.3 0.13	149.0 5.87	7.17 15.81
941	932	Y1S-932	0.8 0.03	117.0 4.61	3.3 0.13	187.0 7.36	22.69 50.05
HH923649	HH923610	HH923610EA	1.5 0.06	130.8 5.15	6.4 0.25	207.0 8.15	36.33 80.12

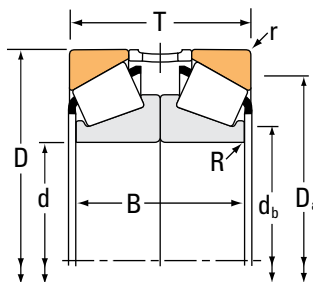
⁽⁵⁾Contact your Timken engineer for information on spacer configurations.

⁽⁶⁾These maximum fillet radii will be cleared by the bearing corners.

TAPERED ROLLER BEARINGS

DOUBLE-ROW • TYPE 2TS-DM

TYPE 2TS-DM



Bearing Dimensions				Load Ratings							
Bore d	O.D. D	Width ⁽¹⁾ T	Width B	Dynamic ⁽²⁾		Factors ⁽³⁾		Dynamic ⁽⁴⁾			Factors ⁽³⁾
				C ₁₍₂₎	e	Y ₁	Y ₂	C ₉₀	C _{a90}	C ₉₀₍₂₎	K
mm in.	mm in.	mm in.	mm in.	N lbf				N lbf	N lbf	N lbf	
106.362 4.1875	165.100 6.5000	73.025 2.8750	73.024 2.8750	394000 88600	0.50	1.36	2.02	58700 13200	50000 11200	102000 23000	1.18
107.950 4.2500	158.750 6.2500	46.040 1.8126	42.876 1.6880	238000 53400	0.61	1.11	1.66	35400 7960	36700 8250	61600 13900	0.96
107.950 4.2500	212.725 8.3750	133.350 5.2500	133.350 5.2500	1180000 266000	0.33	2.07	3.09	176000 39600	98300 22100	307000 69000	1.79
107.950 4.2500	212.725 8.3750	133.350 5.2500	133.350 5.2500	996000 224000	0.33	2.07	3.09	148000 33300	82700 18600	258000 58000	1.79
110.000 4.3307	165.000 6.4961	70.000 2.7560	70.000 2.7560	396000 88900	0.50	1.36	2.02	58900 13200	50100 11300	103000 23100	1.18
110.000 4.3307	200.000 7.8740	112.000 4.4095	106.000 4.1732	858000 193000	0.42	1.61	2.39	128000 28700	91900 20700	222000 50000	1.39
110.000 4.3307	240.000 9.4488	126.000 4.9606	114.000 4.4882	963000 217000	0.83	0.82	1.22	143000 32200	203000 45500	250000 56100	0.71
111.125 4.3750	214.312 8.4375	111.125 4.3750	104.776 4.1250	970000 218000	0.67	1.00	1.49	144000 32500	167000 37500	251000 56500	0.87
114.300 4.5000	177.800 7.0000	82.550 3.2500	82.550 3.2500	478000 108000	0.52	1.31	1.95	71200 16000	62900 14100	124000 27900	1.13
114.300 4.5000	212.725 8.3750	133.350 5.2500	133.350 5.2500	996000 224000	0.33	2.07	3.09	148000 33300	82700 18600	258000 58000	1.79
114.300 4.5000	228.600 9.0000	107.950 4.2500	98.856 3.8920	1020000 230000	0.74	0.92	1.36	152000 34200	192000 43100	265000 59500	0.79
114.300 4.5000	279.400 11.0000	165.100 6.5000	165.100 6.5000	1850000 417000	0.63	1.07	1.59	276000 62100	299000 67200	481000 108000	0.92
120.650 4.7500	199.975 7.8730	92.075 3.6250	92.075 3.6250	629000 142000	0.43	1.58	2.35	93700 21100	68500 15400	163000 36700	1.37
120.650 4.7500	206.375 8.1250	95.250 3.7500	95.250 3.7500	658000 148000	0.46	1.47	2.19	98000 22000	77000 17300	171000 38400	1.27
120.650 4.7500	234.950 9.2500	127.000 5.0000	127.000 5.0000	1090000 246000	0.37	1.83	2.72	163000 36700	103000 23200	284000 63800	1.58
120.650 4.7500	254.000 10.0000	155.575 6.1250	165.100 6.5000	1580000 356000	0.32	2.10	3.13	236000 53000	130000 29200	411000 92400	1.82
120.650 4.7500	273.050 10.7500	165.100 6.5000	165.100 6.5000	1850000 417000	0.63	1.07	1.59	276000 62100	299000 67200	481000 108000	0.92

⁽¹⁾Overall width can vary depending on spacer selection. Contact your Timken engineer for more information.

⁽²⁾Based on 1×10^6 revolutions L_{10} life, for the ISO life-calculation method. $C_{1(2)}$ is the double-row radial value.

⁽³⁾Consult your Timken engineer for instructions on use or review the Timken Engineering Manual on timken.com/catalogs.

⁽⁴⁾Based on 90×10^6 revolutions L_{10} life, for The Timken Company life-calculation method. C_{90} and C_{a90} are radial and thrust values. $C_{90(2)}$ is the double-row radial value.

Part Number			Dimensions				Bearing Weight
Inner	Outer	Outer Spacer ⁽⁵⁾	Shaft		Housing		
			Max. Shaft Fillet Radius R ⁽⁶⁾	Backing Shoulder Dia. d _b	Max. Housing Fillet Radius r ⁽⁶⁾	Max. Backing Shoulder Dia. D _a	
			mm in.	mm in.	mm in.	mm in.	kg lbs.
56418	56650	Y2S-56650	0.5 0.02	116.0 4.57	3.3 0.13	149.0 5.87	5.64 12.42
K37425	K37625	K161710	0.5 0.02	115.0 4.53	3.3 0.13	143.0 5.63	2.92 6.41
HH224340	HH224310	HH224310EC	1.5 0.06	126.0 4.96	3.3 0.13	192.0 7.56	21.35 47.08
936	932	Y1S-932	0.8 0.03	122.0 4.80	3.3 0.13	187.0 7.36	21.57 47.56
JM822049	JM822010	M822010EA	0.3 0.01	119.0 4.69	2.5 0.10	149.0 5.87	5.05 11.17
X32222M	Y32222M	JY20020-Q	1.0 0.04	125.0 4.92	2.5 0.10	179.0 7.05	14.57 32.12
X31322M	Y31322M	JY24050-Q	1.8 0.07	135.0 5.35	3.0 0.12	206.0 8.11	13.82 30.46
H924045	H924010	H924010EA	1.5 0.06	131.2 5.16	3.3 0.13	186.0 7.32	17.33 38.21
64450	64700	Y2S-64700	0.5 0.02	125.0 4.92	3.3 0.13	160.0 6.30	7.18 15.85
938	932	Y6S-932	0.8 0.03	128.0 5.04	3.3 0.13	187.0 7.36	20.79 45.85
HM926740	HM926710	HM926710EE	2.0 0.08	142.0 5.59	3.3 0.13	200.0 7.87	19.77 43.59
HH926744	HH926716	HH926716EC	1.5 0.06	147.2 5.80	6.4 0.25	233.0 9.17	49.76 109.68
HM624749	HM624716	HM624716EA	0.5 0.02	132.0 5.20	1.5 0.06	178.0 7.01	11.50 25.36
795	792	Y3S-792	0.8 0.03	134.0 5.28	3.3 0.13	186.0 7.32	13.32 29.38
95475	95925	Y1S-95925	0.8 0.03	137.0 5.39	3.3 0.13	209.0 8.23	25.89 57.11
HH228340	HH228310	HH228310EA	1.5 0.06	142.0 5.59	6.4 0.25	223.0 8.78	38.54 84.97
HH926749	HH926710	HH926710EB	1.5 0.06	147.2 5.80	6.4 0.25	230.0 9.06	45.20 99.61

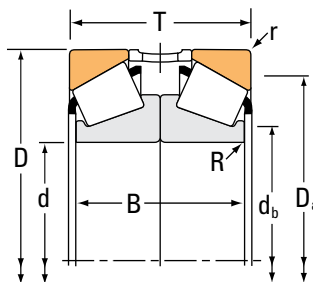
⁽⁵⁾Contact your Timken engineer for information on spacer configurations.

⁽⁶⁾These maximum fillet radii will be cleared by the bearing corners.

TAPERED ROLLER BEARINGS

DOUBLE-ROW • TYPE 2TS-DM

TYPE 2TS-DM



Bearing Dimensions				Load Ratings							
Bore d	O.D. D	Width ⁽¹⁾ T	Width B	Dynamic ⁽²⁾				Dynamic ⁽⁴⁾			
				C ₁₍₂₎	e	Factors ⁽³⁾ Y ₁	Y ₂	C ₉₀	C _{a90}	C ₉₀₍₂₎	Factors ⁽³⁾ K
mm in.	mm in.	mm in.	mm in.	N lbf				N lbf	N lbf	N lbf	
125.298 4.9330	228.600 9.0000	107.950 4.2500	98.857 3.8920	1020000 230000	0.74	0.92	1.36	152000 34200	192000 43100	265000 59500	0.79
127.000 5.0000	182.562 7.1875	79.375 3.1250	76.200 3.0000	466000 105000	0.31	2.21	3.29	69400 15600	36300 8160	121000 27200	1.91
127.000 5.0000	196.850 7.7500	92.075 3.6250	92.075 3.6250	640000 144000	0.34	1.96	2.92	95300 21400	56100 12600	166000 37300	1.70
127.000 5.0000	214.975 8.4636	95.250 3.7500	95.250 3.7500	665000 150000	0.49	1.38	2.06	99000 22300	82600 18600	172000 38800	1.20
127.000 5.0000	215.900 8.5000	95.250 3.7500	95.250 3.7500	665000 150000	0.49	1.38	2.06	99000 22300	82600 18600	172000 38800	1.20
127.000 5.0000	228.600 9.0000	107.950 4.2500	98.857 3.8920	1020000 230000	0.74	0.92	1.36	152000 34200	192000 43100	265000 59500	0.79
127.000 5.0000	234.950 9.2500	127.000 5.0000	127.000 5.0000	1090000 246000	0.37	1.83	2.72	163000 36700	103000 23200	284000 63800	1.58
127.000 5.0000	304.800 12.0000	177.800 7.0000	165.100 6.5000	2020000 453000	0.73	0.93	1.38	300000 67500	374000 84100	522000 117000	0.80
127.792 5.0312	228.600 9.0000	107.950 4.2500	98.857 3.8920	1020000 230000	0.74	0.92	1.36	152000 34200	192000 43100	265000 59500	0.79
130.000 5.1181	206.375 8.1250	95.250 3.7500	95.250 3.7500	658000 148000	0.46	1.47	2.19	98000 22000	77000 17300	171000 38400	1.27
130.000 5.1181	230.000 9.0551	135.500 5.3346	128.000 5.0394	1190000 267000	0.44	1.55	2.31	177000 39800	132000 29600	308000 69200	1.34
130.000 5.1181	280.000 11.0236	144.000 5.6693	132.000 5.1969	1200000 270000	0.83	0.82	1.22	179000 40300	253000 56900	312000 70100	0.71
133.350 5.2500	196.850 7.7500	92.075 3.6250	92.075 3.6250	672000 151000	0.34	1.96	2.92	100000 22500	58900 13300	174000 39200	1.70
133.350 5.2500	215.900 8.5000	95.250 3.7500	95.250 3.7500	665000 150000	0.49	1.38	2.06	99000 22300	82600 18600	172000 38800	1.20
139.700 5.5000	180.975 7.1250	42.865 1.6876	41.276 1.6250	197000 44400	0.37	1.85	2.75	29400 6600	18400 4130	51200 11500	1.60
139.700 5.5000	215.900 8.5000	95.250 3.7500	95.250 3.7500	665000 150000	0.49	1.38	2.06	99000 22300	82600 18600	172000 38800	1.20
139.700 5.5000	254.000 10.0000	133.350 5.2500	133.350 5.2500	1150000 258000	0.41	1.66	2.47	171000 38500	119000 26800	298000 67000	1.43

⁽¹⁾Overall width can vary depending on spacer selection. Contact your Timken engineer for more information.

⁽²⁾Based on 1 x 10⁶ revolutions L₁₀ life, for the ISO life-calculation method. C₁₍₂₎ is the double-row radial value.

⁽³⁾Consult your Timken engineer for instructions on use or review the Timken Engineering Manual on timken.com/catalogs.

⁽⁴⁾Based on 90 x 10⁶ revolutions L₁₀ life, for The Timken Company life-calculation method. C₉₀ and C_{a90} are radial and thrust values. C₉₀₍₂₎ is the double-row radial value.

Part Number			Dimensions				Bearing Weight
Inner	Outer	Outer Spacer ⁽⁵⁾	Shaft		Housing		
			Max. Shaft Fillet Radius R ⁽⁶⁾	Backing Shoulder Dia. d _b	Max. Housing Fillet Radius r ⁽⁶⁾	Max. Backing Shoulder Dia. D _a	
			mm in.	mm in.	mm in.	mm in.	kg lbs.
HM926745	HM926710	HM926710EE	2.0 0.08	143.0 5.63	3.3 0.13	200.0 7.87	18.17 40.05
48290	48220	Y5S-48220	0.5 0.02	135.0 5.31	3.3 0.13	168.0 6.61	8.02 17.68
67388	67322	Y1S-67322	0.8 0.03	138.0 5.43	3.3 0.13	180.0 7.09	10.39 22.92
74500	74845	K160066	1.0 0.04	141.0 5.55	3.3 0.13	196.0 7.72	14.33 31.60
74500	74850	Y4S-74850	1.0 0.04	141.0 5.55	3.3 0.13	196.0 7.72	14.31 31.54
HM926747	HM926710	HM926710EE	2.0 0.08	143.0 5.63	3.3 0.13	200.0 7.87	17.89 39.47
95500	95925	Y1S-95925	0.8 0.03	142.0 5.59	3.3 0.13	209.0 8.23	24.67 54.39
HH932132	HH932110	HH932110EC	1.5 0.06	172.0 6.77	6.4 0.25	260.0 10.24	61.95 136.57
HM926749	HM926710	HM926710EE	2.0 0.08	143.0 5.63	3.3 0.13	200.0 7.87	17.77 39.20
797	792	Y4S-792	0.8 0.03	141.0 5.55	3.3 0.13	186.0 7.32	13.51 29.80
X32226M	Y32226M	JY23028-Q	1.0 0.04	145.0 5.71	3.0 0.12	206.0 8.11	23.43 51.69
X31326M	Y31326M	JY28056-Q	0.8 0.03	163.0 6.42	4.0 0.16	238.0 9.37	41.08 90.56
M327349	67322	Y1S-67322	0.8 0.03	144.0 5.67	3.3 0.13	180.0 7.09	9.42 20.76
74525	74850	Y4S-74850	0.8 0.03	146.0 5.75	3.3 0.13	196.0 7.72	13.35 29.40
LL428349	LL428310	LL428310EA	0.5 0.02	146.0 5.75	1.5 0.06	172.0 6.77	2.61 5.75
74550	74850	Y4S-74850	0.8 0.03	151.0 5.94	3.3 0.13	196.0 7.72	12.33 27.16
99550	99100	Y1S-99100	4.0 0.16	156.0 6.14	3.3 0.13	227.0 8.94	29.52 65.08

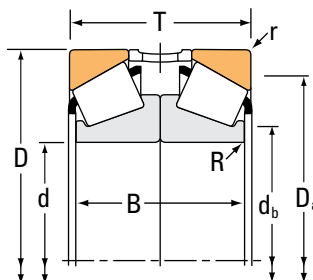
⁽⁵⁾Contact your Timken engineer for information on spacer configurations.

⁽⁶⁾These maximum fillet radii will be cleared by the bearing corners.

TAPERED ROLLER BEARINGS

DOUBLE-ROW • TYPE 2TS-DM

TYPE 2TS-DM



Bearing Dimensions				Load Ratings							
Bore d	O.D. D	Width ⁽¹⁾ T	Width B	Dynamic ⁽²⁾				Dynamic ⁽⁴⁾			
				C ₁₍₂₎	e	Factors ⁽³⁾ Y ₁	Y ₂	C ₉₀	C _{a90}	C ₉₀₍₂₎	Factors ⁽³⁾ K
mm in.	mm in.	mm in.	mm in.	N lbf				N lbf	N lbf	N lbf	
146.050 5.7500	268.288 10.5625	149.225 5.8750	149.225 5.8750	1370000 307000	0.39	1.74	2.59	203000 45700	135000 30300	354000 79600	1.51
146.050 5.7500	304.800 12.0000	177.800 7.0000	165.100 6.5000	2020000 453000	0.73	0.93	1.38	300000 67500	374000 84100	522000 117000	0.80
149.225 5.8750	236.538 9.3125	114.300 4.5000	113.284 4.4600	1040000 234000	0.32	2.12	3.15	155000 34800	84500 19000	269000 60600	1.83
150.000 5.9055	320.000 12.5984	164.000 6.4567	150.000 5.9055	1500000 338000	0.83	0.82	1.22	224000 50300	316000 71000	389000 87500	0.71
152.400 6.0000	222.250 8.7500	93.660 3.6874	93.660 3.6874	607000 136000	0.33	2.03	3.02	90400 20300	51500 11600	157000 35400	1.76
152.400 6.0000	254.000 10.0000	133.350 5.2500	133.350 5.2500	1150000 258000	0.41	1.66	2.47	171000 38500	119000 26800	298000 67000	1.43
152.400 6.0000	307.975 12.1250	177.800 7.0000	187.325 7.3750	2010000 451000	0.33	2.07	3.08	299000 67200	167000 37500	520000 117000	1.79
155.575 6.1250	330.200 13.0000	171.450 6.7500	158.750 6.2500	2140000 481000	0.81	0.83	1.24	319000 71600	441000 99200	555000 125000	0.72
158.750 6.2500	225.425 8.8750	82.550 3.2500	79.375 3.1250	528000 119000	0.38	1.76	2.62	78600 17700	51600 11600	137000 30800	1.52
158.750 6.2500	285.750 11.2500	152.400 6.0000	146.050 5.7500	1240000 280000	0.40	1.68	2.50	185000 41700	128000 28700	323000 72500	1.45
161.925 6.3750	374.650 14.7500	174.625 6.8750	158.750 6.2500	2300000 518000	0.71	0.96	1.42	343000 77200	415000 93300	598000 134000	0.83
165.100 6.5000	247.650 9.7500	95.250 3.7500	95.250 3.7500	705000 159000	0.44	1.54	2.29	105000 23600	79000 17800	183000 41100	1.33
165.100 6.5000	288.925 11.3750	127.000 5.0000	127.000 5.0000	1150000 258000	0.47	1.44	2.15	171000 38500	137000 30800	298000 67000	1.25
165.100 6.5000	311.150 12.2500	165.100 6.5000	165.100 6.5000	1840000 414000	0.33	2.04	3.04	274000 61600	155000 34900	477000 107000	1.77
165.100 6.5000	336.550 13.2500	190.500 7.5000	190.500 7.5000	2880000 648000	0.37	1.82	2.71	429000 96500	273000 61400	748000 168000	1.57
168.275 6.6250	247.650 9.7500	95.250 3.7500	95.250 3.7500	705000 159000	0.44	1.54	2.29	105000 23600	79000 17800	183000 41100	1.33
168.275 6.6250	330.200 13.0000	171.450 6.7500	158.750 6.2500	2140000 481000	0.81	0.83	1.24	319000 71600	441000 99200	555000 125000	0.72

⁽¹⁾Overall width can vary depending on spacer selection. Contact your Timken engineer for more information.

⁽²⁾Based on 1×10^6 revolutions L_{10} life, for the ISO life-calculation method. $C_{1(2)}$ is the double-row radial value.

⁽³⁾Consult your Timken engineer for instructions on use or review the Timken Engineering Manual on timken.com/catalogs.

⁽⁴⁾Based on 90×10^6 revolutions L_{10} life, for The Timken Company life-calculation method. C_{90} and C_{a90} are radial and thrust values. $C_{90(2)}$ is the double-row radial value.

Part Number			Dimensions				Bearing Weight
Inner	Outer	Outer Spacer ⁽⁵⁾	Shaft		Housing		
			Max. Shaft Fillet Radius R ⁽⁶⁾	Backing Shoulder Dia. d _b	Max. Housing Fillet Radius r ⁽⁶⁾	Max. Backing Shoulder Dia. D _a	
			mm in.	mm in.	mm in.	mm in.	kg lbs.
EE107057	107105	Y2S-107105	1.5 0.06	166.0 6.54	6.4 0.25	237.0 9.33	41.74 91.99
HH932145	HH932110	HH932110EC	1.5 0.06	174.0 6.87	6.4 0.25	260.0 10.24	56.73 125.06
HM231149	HM231110	HM231110EC	1.5 0.06	163.0 6.42	3.3 0.13	217.0 8.54	18.48 40.71
X31330M	Y31330M	JY32064-Q	2.0 0.08	187.0 7.36	4.0 0.16	276.0 10.87	60.19 132.61
M231649	M231610	K75277	0.8 0.03	163.0 6.42	1.5 0.06	207.0 8.15	11.94 26.34
99600	99100	Y1S-99100	4.0 0.16	169.7 6.68	3.3 0.13	227.0 8.94	26.46 58.34
HH234048	HH234010	HH234010EC	3.3 0.13	179.0 7.05	6.8 0.27	276.1 10.87	61.59 135.77
H936340	H936310	H936310EA	1.3 0.05	192.4 7.58	6.4 0.25	282.0 11.10	67.25 148.26
46780	46720	Y2S-46720	0.8 0.03	169.0 6.65	3.3 0.13	209.0 8.23	10.66 23.53
EE217062X	217112	Y2S-217112	1.5 0.06	176.0 6.93	6.4 0.25	251.0 9.88	39.70 87.52
EE117063	117148	Y3S-117148	1.5 0.06	197.0 7.76	1.5 0.06	322.0 12.68	88.58 195.27
67780	67720	Y1S-67720	0.5 0.02	179.0 7.05	3.3 0.13	229.0 9.02	16.43 36.24
94649	94113	Y11S-94113	1.5 0.06	186.0 7.32	3.3 0.13	259.0 10.20	40.61 89.52
H238140	H238110	H238110EA	1.5 0.06	188.0 7.40	6.4 0.25	280.0 11.02	56.92 125.51
HH437549	HH437510	HH437510EA	3.3 0.13	196.0 7.72	6.4 0.25	297.0 11.69	79.69 175.70
67782	67720	Y3S-67720	0.5 0.02	181.0 7.13	3.3 0.13	229.0 9.02	15.71 34.65
H936349	H936310	H936310EA	0.8 0.03	192.4 7.58	6.4 0.25	282.0 11.10	63.23 139.40

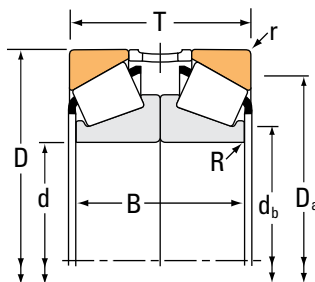
⁽⁵⁾Contact your Timken engineer for information on spacer configurations.

⁽⁶⁾These maximum fillet radii will be cleared by the bearing corners.

TAPERED ROLLER BEARINGS

DOUBLE-ROW • TYPE 2TS-DM

TYPE 2TS-DM



Bearing Dimensions				Load Ratings							
Bore d	O.D. D	Width ⁽¹⁾ T	Width B	Dynamic ⁽²⁾				Dynamic ⁽⁴⁾			
				C ₁₍₂₎	e	Factors ⁽³⁾ Y ₁	Y ₂	C ₉₀	C _{a90}	C ₉₀₍₂₎	Factors ⁽³⁾ K
mm in.	mm in.	mm in.	mm in.	N lbf				N lbf	N lbf	N lbf	
169.975 6.6919	260.350 10.2500	133.350 5.2500	133.350 5.2500	1140000 256000	0.40	1.68	2.50	169000 38100	117000 26200	295000 66300	1.45
170.000 6.6929	230.000 9.0551	76.000 2.9921	76.000 2.9922	618000 139000	0.38	1.76	2.62	92000 20700	60400 13600	160000 36000	1.52
170.000 6.6929	230.000 9.0551	78.000 3.0708	76.000 2.9922	583000 131000	0.38	1.76	2.62	86800 19500	56900 12800	151000 34000	1.52
170.000 6.6929	240.000 9.4488	92.000 3.6220	89.000 3.5040	667000 150000	0.44	1.54	2.30	99300 22300	74300 16700	173000 38900	1.34
170.000 6.6929	254.000 10.0000	92.075 3.6250	92.076 3.6250	867000 195000	0.37	1.83	2.72	129000 29000	81600 18300	225000 50500	1.58
170.000 6.6929	260.000 10.2362	114.000 4.4882	114.000 4.4882	1060000 239000	0.44	1.52	2.26	158000 35500	120000 27000	275000 61900	1.31
171.450 6.7500	374.650 14.7500	174.625 6.8750	158.750 6.2500	2300000 518000	0.71	0.96	1.42	343000 77200	415000 93300	598000 134000	0.83
174.625 6.8750	247.650 9.7500	95.250 3.7500	95.250 3.7500	705000 159000	0.44	1.54	2.29	105000 23600	79000 17800	183000 41100	1.33
177.800 7.0000	247.650 9.7500	95.250 3.7500	95.250 3.7500	705000 159000	0.44	1.54	2.29	105000 23600	79000 17800	183000 41100	1.33
177.800 7.0000	279.400 11.0000	123.825 4.8750	123.824 4.8750	930000 209000	0.52	1.29	1.92	138000 31100	124000 28000	241000 54200	1.11
177.800 7.0000	288.925 11.3750	127.000 5.0000	127.000 5.0000	1700000 382000	0.32	2.12	3.15	253000 56900	138000 31100	441000 99100	1.83
177.800 7.0000	355.600 14.0000	158.750 6.2500	155.576 6.1250	1850000 416000	0.55	1.24	1.84	276000 62000	258000 57900	480000 108000	1.07
177.800 7.0000	428.625 16.8750	212.726 8.3750	190.500 7.5000	2620000 588000	0.76	0.89	1.33	390000 87600	506000 114000	679000 153000	0.77
180.000 7.0866	250.000 9.8425	90.000 3.5434	90.000 3.5434	712000 160000	0.48	1.41	2.09	106000 23800	87200 19600	185000 41500	1.22
180.000 7.0866	250.000 9.8425	90.000 3.5434	90.000 3.5434	702000 158000	0.48	1.41	2.09	105000 23500	85900 19300	182000 40900	1.22
180.000 7.0866	280.000 11.0236	128.000 5.0394	128.000 5.0394	1230000 277000	0.42	1.60	2.38	183000 41200	133000 29800	319000 71700	1.38
190.000 7.4803	260.000 10.2362	92.000 3.6220	88.000 3.4646	708000 159000	0.48	1.41	2.11	105000 23700	86200 19400	184000 41300	1.22

⁽¹⁾Overall width can vary depending on spacer selection. Contact your Timken engineer for more information.

⁽²⁾Based on 1×10^6 revolutions L_{10} life, for the ISO life-calculation method. $C_{1(2)}$ is the double-row radial value.

⁽³⁾Consult your Timken engineer for instructions on use or review the Timken Engineering Manual on timken.com/catalogs.

⁽⁴⁾Based on 90×10^6 revolutions L_{10} life, for The Timken Company life-calculation method. C_{90} and C_{a90} are radial and thrust values. $C_{90(2)}$ is the double-row radial value.

Part Number			Dimensions				Bearing Weight
Inner	Outer	Outer Spacer ⁽⁵⁾	Shaft		Housing		
			Max. Shaft Fillet Radius R ⁽⁶⁾	Backing Shoulder Dia. d _b	Max. Housing Fillet Radius r ⁽⁶⁾	Max. Backing Shoulder Dia. D _a	
			mm in.	mm in.	mm in.	mm in.	kg lbs.
HM535347	HM535310	HM535310EA	1.5 0.06	186.1 7.40	3.3 0.13	236.0 9.29	25.94 57.22
X32934M	Y32934M	K167396	0.6 0.03	179.0 7.05	2.0 0.08	215.0 8.46	9.14 20.15
JHM534149	JHM534110	HM534110EB	0.5 0.02	178.0 7.01	2.5 0.10	217.0 8.54	8.90 19.59
JM734449A	JM734410	M734410EB	0.5 0.02	180.0 7.09	2.5 0.10	222.0 8.74	12.80 28.19
86669	86100	Y2S-86100	0.8 0.03	180.0 7.09	3.3 0.13	234.0 9.21	15.10 33.27
X32034XM	Y32034XM	K166076	1.0 0.04	187.0 7.36	2.5 0.10	238.0 9.37	21.75 47.79
EE117067	117148	Y3S-117148	1.5 0.06	205.0 8.07	1.5 0.06	322.0 12.68	85.52 188.51
67786	67720	Y1S-67720	0.5 0.02	185.0 7.28	3.3 0.13	229.0 9.02	14.45 31.85
67790	67720	Y3S-67720	0.5 0.02	188.0 7.40	3.3 0.13	229.0 9.02	13.79 30.39
82680X	82620	Y2S-82620	1.5 0.06	195.0 7.68	3.3 0.13	251.0 9.88	28.09 61.94
HM237545	HM237510	HM237510ED	1.5 0.06	194.0 7.64	3.3 0.13	266.0 10.47	31.62 69.75
EE607070	607140	Y1S-607140	1.5 0.06	204.0 8.03	6.4 0.25	311.9 12.28	72.51 159.87
EE350701	351687	Y1S-351687	1.5 0.06	221.0 8.70	6.4 0.25	365.0 14.37	145.48 320.70
JM736149	JM736110	JY25020-S	0.5 0.02	190.5 7.50	2.5 0.10	232.0 9.13	13.77 30.34
X32936M	Y32936M	K163398	0.6 0.03	192.0 7.56	2.0 0.08	231.0 9.09	13.43 29.63
X32036XM	Y32036XM	K160264	1.0 0.04	197.0 7.76	2.5 0.10	256.0 10.08	28.80 63.46
JM738249	JM738210	K161599	0.5 0.02	200.0 7.87	2.5 0.10	242.0 9.53	14.06 30.99

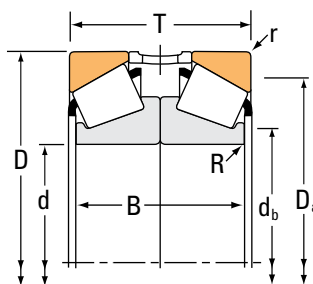
⁽⁵⁾Contact your Timken engineer for information on spacer configurations.

⁽⁶⁾These maximum fillet radii will be cleared by the bearing corners.

TAPERED ROLLER BEARINGS

DOUBLE-ROW • TYPE 2TS-DM

TYPE 2TS-DM



Bearing Dimensions				Load Ratings							
Bore d	O.D. D	Width ⁽¹⁾ T	Width B	Dynamic ⁽²⁾				Dynamic ⁽⁴⁾			
				C ₁₍₂₎	e	Factors ⁽³⁾ Y ₁	Y ₂	C ₉₀	C _{a90}	C ₉₀₍₂₎	Factors ⁽³⁾ K
mm in.	mm in.	mm in.	mm in.	N lbf				N lbf	N lbf	N lbf	
190.000 7.4803	290.000 11.4173	128.000 5.0394	128.000 5.0394	1250000 281000	0.44	1.53	2.27	186000 41900	141000 31700	325000 73000	1.32
190.500 7.5000	336.550 13.2500	165.100 6.5000	168.276 6.6250	1640000 370000	0.37	1.85	2.75	245000 55000	153000 34400	426000 95800	1.60
190.500 7.5000	336.550 13.2500	196.850 7.7500	190.500 7.5000	2010000 451000	0.58	1.17	1.75	299000 67100	294000 66200	520000 117000	1.01
190.500 7.5000	428.625 16.8750	212.725 8.3750	190.500 7.5000	2860000 644000	0.76	0.89	1.33	426000 95900	554000 124000	742000 167000	0.77
196.850 7.7500	254.000 10.0000	57.150 2.2500	55.566 2.1876	367000 82500	0.40	1.70	2.53	54700 12300	37100 8350	95200 21400	1.47
200.000 7.8740	310.000 12.2047	140.000 5.5118	140.000 5.5118	1480000 332000	0.43	1.57	2.34	220000 49400	162000 36400	383000 86000	1.36
203.200 8.0000	365.049 14.3720	184.150 7.2500	177.794 6.9998	2030000 457000	0.40	1.68	2.50	303000 68100	208000 46800	527000 118000	1.45
203.200 8.0000	406.400 16.0000	184.150 7.2500	171.450 6.7500	2120000 477000	0.80	0.85	1.26	316000 71000	431000 97000	550000 124000	0.73
204.788 8.0625	292.100 11.5000	115.888 4.5626	115.890 4.5626	1040000 235000	0.33	2.03	3.02	156000 35000	88500 19900	271000 60900	1.76
206.375 8.1250	336.550 13.2500	196.850 7.7500	200.024 7.8750	2360000 530000	0.33	2.03	3.02	351000 79000	200000 45000	612000 137000	1.76
209.550 8.2500	317.500 12.5000	127.000 5.0000	127.000 5.0000	1270000 286000	0.52	1.29	1.92	190000 42600	170000 38200	330000 74200	1.12
209.550 8.2500	333.375 13.1250	139.700 5.5000	139.700 5.5000	1600000 359000	0.44	1.54	2.29	238000 53400	179000 40200	414000 93000	1.33
209.550 8.2500	355.600 14.0000	136.525 5.3750	133.350 5.2500	1320000 297000	0.59	1.14	1.70	197000 44200	199000 44700	343000 77000	0.99
215.900 8.5000	290.010 11.4177	63.500 2.5000	63.500 2.5000	416000 93600	0.39	1.75	2.61	62000 13900	40900 9190	108000 24300	1.52
222.250 8.7500	482.600 19.0000	234.950 9.2500	190.500 7.5000	2870000 646000	0.87	0.78	1.16	428000 96200	635000 143000	745000 168000	0.67
228.397 8.9920	431.800 17.0000	184.149 7.2500	171.450 6.7500	2220000 499000	0.88	0.76	1.14	330000 74300	500000 112000	575000 129000	0.66
228.460 8.9945	431.800 17.0000	184.150 7.2500	171.450 6.7500	2220000 499000	0.88	0.76	1.14	330000 74300	500000 112000	575000 129000	0.66

⁽¹⁾Overall width can vary depending on spacer selection. Contact your Timken engineer for more information.

⁽²⁾Based on 1×10^6 revolutions L_{10} life, for the ISO life-calculation method. $C_{1(2)}$ is the double-row radial value.

⁽³⁾Consult your Timken engineer for instructions on use or review the Timken Engineering Manual on timken.com/catalogs.

⁽⁴⁾Based on 90×10^6 revolutions L_{10} life, for The Timken Company life-calculation method. C_{90} and C_{a90} are radial and thrust values. $C_{90(2)}$ is the double-row radial value.

Part Number			Dimensions				Bearing Weight
Inner	Outer	Outer Spacer ⁽⁵⁾	Shaft		Housing		
			Max. Shaft Fillet Radius R ⁽⁶⁾	Backing Shoulder Dia. d _b	Max. Housing Fillet Radius r ⁽⁶⁾	Max. Backing Shoulder Dia. D _a	
			mm in.	mm in.	mm in.	mm in.	kg lbs.
X32038XM	Y32038XM	K162211	1.0 0.04	207.0 8.15	2.5 0.10	267.0 10.51	30.16 66.48
470975	470132	Y1S-470132	1.5 0.06	210.0 8.27	6.4 0.25	298.0 11.73	61.46 135.50
HH840249	HH840210	HH840210EA	1.5 0.06	215.7 8.49	6.4 0.25	290.0 11.42	74.14 163.45
EE350750	351687	Y1S-351687	6.4 0.25	237.0 9.33	6.4 0.25	365.0 14.37	139.80 308.21
L540049	L540010	L540010EA	0.8 0.03	205.0 8.07	1.5 0.06	243.0 9.57	6.97 15.37
X32040XM	Y32040XM	K165677	1.5 0.06	220.0 8.66	2.5 0.10	284.0 11.18	39.08 86.14
EE420801	421437	Y2S-421437	1.5 0.06	227.1 8.94	3.3 0.13	329.0 12.95	78.68 173.48
EE114080	114160	Y2S-114160	1.5 0.06	237.0 9.33	6.4 0.25	349.0 13.74	102.70 226.43
M241549	M241510	M241510EC	1.5 0.06	219.0 8.62	3.3 0.13	272.0 10.71	24.60 54.22
H242649	H242610	K162083	1.5 0.06	227.0 8.94	3.3 0.13	306.0 12.05	68.69 151.44
93825	93125	Y6S-93125	1.3 0.05	226.9 8.93	3.3 0.13	286.0 11.26	35.47 78.21
HM743345	HM743310	HM743310EB	1.5 0.06	228.0 8.98	6.4 0.25	303.0 11.93	46.10 101.64
96825	96140	Y7S-96140	1.5 0.06	235.0 9.25	3.3 0.13	318.0 12.52	57.44 126.67
543085	543114	Y2S-543114	0.8 0.03	226.0 8.90	3.3 0.13	272.0 10.71	11.62 25.62
EE380875	380190	Y2S-380190	1.5 0.06	267.0 10.51	6.4 0.25	402.0 15.83	193.74 427.10
EE113089	113170	Y2S-113170	3.3 0.13	267.0 10.51	6.4 0.25	375.0 14.76	114.78 253.04
EE113091	113170	Y4S-113170	3.3 0.13	267.0 10.51	6.4 0.25	375.0 14.76	115.43 254.48

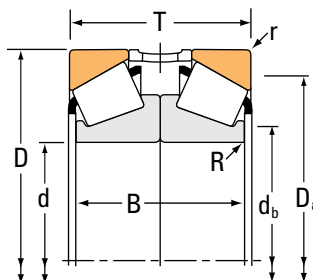
⁽⁵⁾Contact your Timken engineer for information on spacer configurations.

⁽⁶⁾These maximum fillet radii will be cleared by the bearing corners.

TAPERED ROLLER BEARINGS

DOUBLE-ROW • TYPE 2TS-DM

TYPE 2TS-DM



Bearing Dimensions				Load Ratings							
Bore d	O.D. D	Width ⁽¹⁾ T	Width B	Dynamic ⁽²⁾		Factors ⁽³⁾		Dynamic ⁽⁴⁾			Factors ⁽³⁾
				C ₁₍₂₎	e	Y ₁	Y ₂	C ₉₀	C _{a90}	C ₉₀₍₂₎	K
mm in.	mm in.	mm in.	mm in.	N lbf				N lbf	N lbf	N lbf	
228.600 9.0000	300.038 11.8125	66.675 2.6250	63.500 2.5000	414000 93000	0.40	1.68	2.50	61600 13900	42400 9530	107000 24100	1.45
228.600 9.0000	320.675 12.6250	101.600 4.0000	98.424 3.8750	961000 216000	0.49	1.39	2.06	143000 32200	119000 26800	249000 56000	1.20
228.600 9.0000	355.600 14.0000	136.525 5.3750	133.350 5.2500	1320000 297000	0.59	1.14	1.70	197000 44200	199000 44700	343000 77000	0.99
228.600 9.0000	488.950 19.2500	247.650 9.7500	222.250 8.7500	3910000 879000	0.94	0.72	1.07	582000 131000	934000 210000	1010000 228000	0.62
228.600 9.0000	508.000 20.0000	234.950 9.2500	190.500 7.5000	2920000 656000	0.94	0.72	1.07	434000 97700	697000 157000	756000 170000	0.62
234.950 9.2500	384.175 15.1250	225.425 8.8750	225.424 8.8750	2920000 656000	0.33	2.03	3.02	434000 97600	247000 55600	756000 170000	1.76
240.000 9.4488	360.000 14.1732	152.000 5.9842	152.000 5.9842	2060000 463000	0.46	1.47	2.19	306000 68900	241000 54100	534000 120000	1.27
247.650 9.7500	406.400 16.0000	231.775 9.1250	234.950 9.2500	3620000 814000	0.33	2.03	3.02	539000 121000	307000 69000	939000 211000	1.76
254.000 10.0000	533.400 21.0000	266.700 10.5000	241.300 9.5000	4670000 1050000	0.94	0.72	1.07	696000 156000	1120000 251000	1210000 272000	0.62
254.000 10.0000	558.800 22.0000	209.550 8.2500	209.550 8.2500	3130000 704000	0.87	0.78	1.16	466000 105000	691000 155000	812000 182000	0.67
264.975 10.4321	355.600 14.0000	114.300 4.5000	124.000 4.8818	1270000 286000	0.36	1.87	2.79	189000 42600	117000 26300	330000 74200	1.62
266.700 10.5000	444.500 17.5000	241.300 9.5000	234.950 9.2500	3180000 714000	0.58	1.17	1.75	473000 106000	466000 105000	823000 185000	1.01
285.750 11.2500	358.775 14.1250	66.675 2.6250	63.500 2.5000	449000 101000	0.49	1.37	2.04	66800 15000	56300 12600	116000 26200	1.19
304.800 12.0000	406.400 16.0000	127.000 5.0000	127.000 5.0000	1340000 301000	0.44	1.53	2.28	199000 44800	151000 33900	347000 78100	1.32
304.800 12.0000	499.948 19.6830	203.200 8.0000	158.750 6.2500	2330000 523000	1.17	0.58	0.86	346000 77900	695000 156000	603000 136000	0.50
360.000 14.1732	480.000 18.8976	152.000 5.9843	152.000 5.9842	2170000 489000	0.46	1.47	2.19	324000 72800	254000 57100	564000 127000	1.27
381.000 15.0000	479.425 18.8750	98.425 3.8750	95.250 3.7500	1030000 232000	0.50	1.36	2.03	154000 34600	130000 29300	268000 60300	1.18

⁽¹⁾Overall width can vary depending on spacer selection. Contact your Timken engineer for more information.

⁽²⁾Based on 1×10^6 revolutions L_{10} life, for the ISO life-calculation method. $C_{1(2)}$ is the double-row radial value.

⁽³⁾Consult your Timken engineer for instructions on use or review the Timken Engineering Manual on timken.com/catalogs.

⁽⁴⁾Based on 90×10^6 revolutions L_{10} life, for The Timken Company life-calculation method. C_{90} and C_{a90} are radial and thrust values. $C_{90(2)}$ is the double-row radial value.

Part Number			Dimensions				Bearing Weight
Inner	Outer	Outer Spacer ⁽⁵⁾	Shaft		Housing		
			Max. Shaft Fillet Radius R ⁽⁶⁾	Backing Shoulder Dia. d _b	Max. Housing Fillet Radius r ⁽⁶⁾	Max. Backing Shoulder Dia. D _a	
			mm in.	mm in.	mm in.	mm in.	kg lbs.
544090	544118	Y4S-544118	1.5 0.06	240.0 9.45	3.3 0.13	282.0 11.10	11.91 26.22
88900	88126	Y1S-88126	0.8 0.03	242.0 9.53	3.3 0.13	299.0 11.77	23.73 52.27
96900	96140	Y5S-96140	1.5 0.06	249.0 9.80	3.3 0.13	318.0 12.52	49.44 109.04
HH949549	HH949510	K80686	1.5 0.06	280.0 11.02	6.4 0.25	416.0 16.38	214.23 472.33
EE390090	390200	Y1S-390200	1.5 0.06	277.0 10.91	6.4 0.25	423.0 16.65	215.02 474.05
H247549	H247510	H247510EB	1.5 0.06	263.0 10.35	6.4 0.25	346.0 13.62	104.72 230.88
X32048X	Y32048X	K163891	2.0 0.08	259.0 10.20	3.0 0.12	331.0 13.03	53.32 117.52
HH249949	HH249910	HH249910ES	1.5 0.06	275.0 10.83	6.4 0.25	366.0 14.41	125.29 276.23
HH953749	HH953710	K85370	1.5 0.06	306.3 12.06	6.4 0.25	455.0 17.91	275.73 607.88
EE620100	620220	Y1S-620220	3.3 0.13	308.0 12.13	8.0 0.31	477.0 18.78	282.99 623.87
LM451347	LM451310	LM451310EC	1.5 0.06	280.0 11.02	3.3 0.13	335.0 13.19	32.47 71.59
H852849	H852810	H852810EB	1.5 0.06	296.9 11.69	6.4 0.25	390.0 15.35	150.83 332.55
545112	545141	Y2S-545141	1.5 0.06	298.0 11.73	3.3 0.13	340.0 13.39	15.01 33.08
LM757049	LM757010	LM757010ES	1.5 0.06	322.0 12.68	3.3 0.13	380.0 14.96	43.24 95.31
M959442	M959410	M959410EB	1.5 0.06	344.0 13.54	6.4 0.25	438.0 17.24	138.33 304.94
X32972M	Y32972M	K161931	1.5 0.06	378.0 14.88	3.0 0.12	451.0 17.76	92.80 164.88
L865547	L865512	L865512EA	0.8 0.03	395.0 15.55	3.3 0.13	456.0 17.95	39.00 85.96

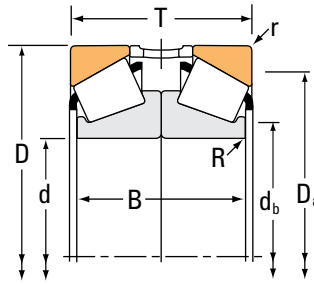
⁽⁵⁾Contact your Timken engineer for information on spacer configurations.

⁽⁶⁾These maximum fillet radii will be cleared by the bearing corners.

TAPERED ROLLER BEARINGS

DOUBLE-ROW • TYPE 2TS-DM

TYPE 2TS-DM



Bearing Dimensions				Load Ratings							
Bore d	O.D. D	Width ⁽¹⁾ T	Width B	Dynamic ⁽²⁾				Dynamic ⁽⁴⁾			
				C ₁₍₂₎	e	Factors ⁽³⁾ Y ₁	Y ₂	C ₉₀	C _{a90}	C ₉₀₍₂₎	Factors ⁽³⁾ K
mm in.	mm in.	mm in.	mm in.	N lbf				N lbf	N lbf	N lbf	
400.000 15.7480	510.000 20.0787	124.000 4.8819	124.000 4.8818	1720000 386000	0.37	1.85	2.75	255000 57400	160000 35900	445000 100000	1.60
406.400 16.0000	549.275 21.6250	171.450 6.7500	168.276 6.6250	2490000 561000	0.41	1.66	2.47	371000 83500	259000 58200	646000 145000	1.43
431.800 17.0000	571.500 22.5000	149.225 5.8750	149.224 5.8750	2140000 481000	0.55	1.24	1.84	319000 71700	298000 67000	555000 125000	1.07
460.000 18.1102	860.000 33.8583	420.000 16.5354	380.000 14.9606	12500000 2810000	0.58	1.17	1.75	1860000 419000	1840000 413000	3240000 729000	1.01
476.250 18.7500	565.150 22.2500	82.550 3.2500	82.550 3.2500	817000 184000	0.47	1.44	2.14	122000 27400	97800 22000	212000 47600	1.24
482.600 19.0000	615.950 24.2500	107.950 4.2500	92.076 3.6250	1140000 257000	0.35	1.93	2.88	170000 38200	102000 22900	296000 66600	1.67
560.000 22.0472	1080.000 42.5197	530.022 20.8670	470.000 18.5040	18600000 4190000	0.47	1.45	2.16	2770000 624000	2210000 497000	4830000 1090000	1.25
710.000 27.9528	950.000 37.4016	226.000 8.8976	212.000 8.3464	7050000 1580000	0.46	1.47	2.19	1050000 236000	824000 185000	1830000 411000	1.27
723.900 28.5000	914.400 36.0000	168.275 6.6250	161.924 6.3750	4150000 934000	0.38	1.77	2.64	619000 139000	403000 90600	1080000 242000	1.54
762.000 30.0000	889.000 35.0000	139.700 5.5000	139.700 5.5000	1880000 423000	0.38	1.78	2.65	280000 62900	182000 40800	488000 110000	1.54
857.250 33.7500	1092.200 43.0000	241.300 9.5000	222.250 8.7500	5060000 1140000	0.56	1.21	1.80	754000 169000	719000 162000	1310000 295000	1.05

⁽¹⁾Overall width can vary depending on spacer selection. Contact your Timken engineer for more information.

⁽²⁾Based on 1×10^6 revolutions L_{10} life, for the ISO life-calculation method. $C_{1(2)}$ is the double-row radial value.

⁽³⁾Consult your Timken engineer for instructions on use or review the Timken Engineering Manual on timken.com/catalogs.

⁽⁴⁾Based on 90×10^6 revolutions L_{10} life, for The Timken Company life-calculation method. C_{90} and C_{a90} are radial and thrust values. $C_{90(2)}$ is the double-row radial value.

Part Number			Dimensions				Bearing Weight
Inner	Outer	Outer Spacer ⁽⁵⁾	Shaft		Housing		
			Max. Shaft Fillet Radius R ⁽⁶⁾	Backing Shoulder Dia. d _b	Max. Housing Fillet Radius r ⁽⁶⁾	Max. Backing Shoulder Dia. D _a	
			mm in.	mm in.	mm in.	mm in.	kg lbs.
NP852610	NP588721	K167429	1.5 0.06	418.0 16.46	3.3 0.13	484.0 19.06	62.34 137.44
LM567949	LM567910	LM567910EA	1.5 0.06	427.0 16.81	3.3 0.13	519.0 20.43	111.23 245.21
LM869448	LM869410	LM869410EB	1.5 0.06	453.0 17.83	3.3 0.13	537.0 21.14	102.28 225.49
NP837820	NP562053	K163378	2.5 0.10	540.0 21.26	6.0 0.24	765.0 30.12	1087.00 2396.41
LL771948	LL771911	LL771911EA	1.5 0.06	491.0 19.33	3.3 0.13	543.0 21.38	39.55 87.18
80480	80425	Y3S-80425	1.5 0.06	501.0 19.72	3.3 0.13	582.0 22.91	74.57 164.36
NP378108	NP676901	K165076	9.5 0.37	660.0 25.98	12.7 0.50	954.0 37.56	2182.15 4810.80
NP194866	NP089744	K167026	3.0 0.12	744.0 29.29	6.0 0.24	897.0 35.31	445.68 982.52
EE755285	755360	K162084	1.5 0.06	750.0 29.53	6.4 0.25	873.0 34.37	260.54 574.38
EE175300	175350	Y2S-175350	1.5 0.06	780.0 30.71	3.3 0.13	855.0 33.66	141.22 311.37
EE157337	157430	Y1S-157430	3.3 0.13	894.0 35.20	6.4 0.25	1035.0 40.75	516.72 1139.23

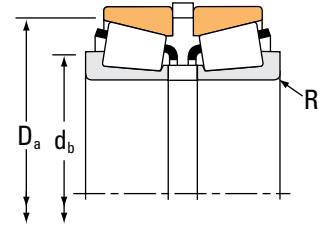
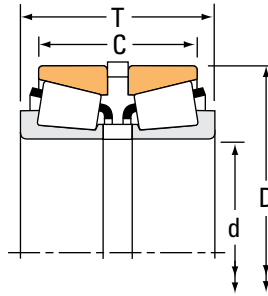
⁽⁵⁾ Contact your Timken engineer for information on spacer configurations.

⁽⁶⁾ These maximum fillet radii will be cleared by the bearing corners.

TAPERED ROLLER BEARINGS

DOUBLE-ROW • TYPE 2S

TYPE 2S



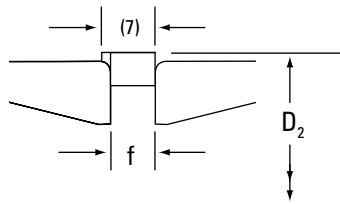
Bearing Dimensions				Load Ratings							
Bore d	O.D. D	Width ⁽¹⁾ T	Width C	Dynamic ⁽²⁾				Dynamic ⁽⁴⁾			
				C ₁₍₂₎	e	Factors ⁽³⁾ Y ₁	Y ₂	C ₉₀	C _{a90}	C ₉₀₍₂₎	Factors ⁽³⁾ K
mm in.	mm in.	mm in.	mm in.	N lbf				N lbf	N lbf	N lbf	
14.989 0.5901	34.988 1.3775	24.536 0.9660	20.000 0.7874	22900 5150	0.45	1.49	2.22	3410 767	2640 594	5940 1330	1.29
17.462 0.6875	39.878 1.5700	30.226 1.1900	23.876 0.9400	51100 11500	0.29	2.36	3.51	7610 1710	3730 838	13300 2980	2.04
19.050 0.7500	45.237 1.7810	38.100 1.5000	31.242 1.2300	68100 15300	0.30	2.25	3.34	10100 2280	5220 1170	17700 3970	1.94
25.400 1.0000	50.292 1.9800	31.623 1.2450	24.511 0.9650	62000 13900	0.37	1.80	2.69	9230 2080	5910 1330	16100 3610	1.56
25.400 1.0000	57.150 2.2500	39.243 1.5450	31.308 1.2326	94900 21300	0.35	1.95	2.90	14100 3180	8380 1880	24600 5530	1.69
31.750 1.2500	59.131 2.3280	35.712 1.4060	27.584 1.0860	81300 18300	0.41	1.64	2.44	12100 2720	8550 1920	21100 4740	1.42
31.750 1.2500	62.000 2.4409	46.355 1.8250	36.830 1.4500	104000 23400	0.35	1.93	2.87	15500 3490	9310 2090	27000 6080	1.67
33.337 1.3125	68.262 2.6875	46.812 1.8430	37.286 1.4680	133000 29900	0.55	1.24	1.84	19800 4450	18500 4160	34400 7740	1.07
34.925 1.3750	65.088 2.5625	39.624 1.5600	31.496 1.2400	112000 25300	0.38	1.79	2.67	16700 3760	10800 2430	29200 6550	1.55
34.925 1.3750	65.088 2.5625	49.276 1.9400	41.148 1.6200	112000 25300	0.38	1.79	2.67	16700 3760	10800 2430	29200 6550	1.55
34.925 1.3750	72.233 2.8438	55.730 2.1941	44.614 1.7565	134000 30100	0.55	1.24	1.84	19900 4480	18600 4180	34700 7790	1.07
35.000 1.3780	73.025 2.8750	56.337 2.2180	46.812 1.8430	156000 35000	0.37	1.83	2.72	23200 5210	14700 3300	40400 9080	1.58
38.100 1.5000	65.088 2.5625	39.624 1.5600	31.496 1.2400	84600 19000	0.33	2.03	3.02	12600 2830	7170 1610	21900 4930	1.76
38.100 1.5000	65.088 2.5625	39.624 1.5600	31.496 1.2400	84600 19000	0.33	2.03	3.02	12600 2830	7170 1610	21900 4930	1.76
41.275 1.6250	73.431 2.8910	42.113 1.6580	32.461 1.2780	130000 29300	0.40	1.69	2.52	19400 4360	13300 2980	33800 7590	1.46
41.275 1.6250	73.431 2.8910	42.672 1.6800	33.020 1.3000	130000 29300	0.40	1.69	2.52	19400 4360	13300 2980	33800 7590	1.46
45.000 1.7717	75.000 2.9528	44.560 1.7543	35.560 1.4000	137000 30800	0.39	1.72	2.56	20400 4590	13700 3080	35500 7990	1.49

⁽¹⁾Overall width can vary depending on spacer selection. Contact your Timken engineer for more information.

⁽²⁾Based on 1×10^6 revolutions L_{10} life, for the ISO life-calculation method. $C_{1(2)}$ is the double-row radial value.

⁽³⁾Consult your Timken engineer for instructions on use or review the Timken Engineering Manual on timken.com/catalogs.

⁽⁴⁾Based on 90×10^6 revolutions L_{10} life, for The Timken Company life-calculation method. C_{90} and C_{a90} are radial and thrust values. $C_{90(2)}$ is the double-row radial value.



⁽⁷⁾Housing groove width with less than critical location =
 $f + 0.25 \text{ mm} \quad +0.10 \text{ mm}$
 $f + 0.010 \text{ in.} \quad -0.10 \text{ mm tolerance}$
 $\quad \quad \quad +0.004 \text{ in.}$
 $\quad \quad \quad -0.000 \text{ in. tolerance}$

Part Number				Dimensions					Bearing Weight
Inner	Outer	Inner Spacer ⁽⁵⁾	Outer Spacer ⁽⁵⁾	Shaft		Housing	Snap Ring Groove		
				Max Shaft Fillet Radius	Backing Shoulder Dia.	Backing Shoulder Dia.	D ₂	f ⁽⁷⁾	
				R ⁽⁶⁾	d _b	D _a			
				mm in.	mm in.	mm in.	mm in.	mm in.	
A4059	A4138	X5SA4059	K524667R	0.8 0.03	19.5 0.77	32.0 1.26	36.35 1.43	2.54 0.10	0.10 0.24
LM11749	LM11710	K106398R	K106397R	1.3 0.05	24.0 0.94	37.0 1.46	41.91 1.65	2.54 0.10	0.19 0.39
LM11949	LM11910	K107061R	K107087R	1.3 0.05	25.0 0.98	41.5 1.63	46.81 1.84	7.11 0.28	0.28 0.63
L44643	L44610	K106790R	K106789R	1.3 0.05	32.0 1.26	47.0 1.85	52.78 2.08	3.18 0.13	0.28 0.60
15578	15520	X1S-15578	K158879R	1.3 0.05	32.5 1.28	53.0 2.09	59.72 2.35	0.34 0.17	0.47 1.02
LM67048	LM67010	K106817R	K106610R	3.5 0.14	42.5 1.67	56.0 2.20	61.11 2.41	3.96 0.16	0.39 0.84
15125	15245	X1S-15125	K159808R	3.5 0.14	42.5 1.67	58.0 2.28	64.52 2.54	8.26 0.33	0.56 1.23
M88048	M88010	K147783R	K528895R	0.8 0.03	42.5 1.67	65.0 2.56	72.34 2.85	2.36 0.09	0.78 1.73
LM48548	LM48510	K106389R	K106390R	3.5 0.14	48.0 1.89	61.0 2.40	67.46 2.66	3.56 0.14	0.53 1.14
LM48548	LM48510	LM48548XE	K106390R	3.5 0.14	48.0 1.89	61.0 2.40	67.46 2.66	3.56 0.14	0.57 1.23
HM88649	HM88610	K152757	K152758	2.3 0.09	48.5 1.91	69.0 2.72	75.00 2.95	4.93 0.19	1.03 2.29
23691	23621	K143257R	K109519R	3.5 0.14	49.0 1.93	68.0 2.68	76.48 3.01	2.36 0.09	1.06 2.34
LM29749	LM29710	K106393R	K106390R	2.3 0.09	46.5 1.83	62.0 2.44	67.46 2.66	3.56 0.14	0.50 1.09
LM29748	LM29710	K106393R	K106390R	3.5 0.14	49.0 1.93	62.0 2.44	67.46 2.66	3.56 0.14	0.48 1.05
LM501349	LM501310	K426891R	K150486R	3.5 0.14	54.0 2.13	70.0 2.76	76.20 3.00	3.00 0.12	0.71 1.55
LM501349	LM501310	K426891R	K426892R	3.5 0.14	54.0 2.13	70.0 2.76	76.20 3.00	3.56 0.14	0.72 1.56
X32009X	Y32009X	JX4505A	K143262R	1.0 0.04	53.0 2.09	72.0 2.83	78.50 3.09	4.57 0.18	0.75 1.66

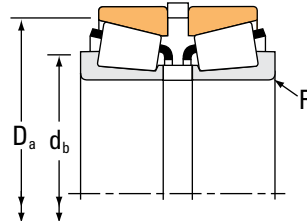
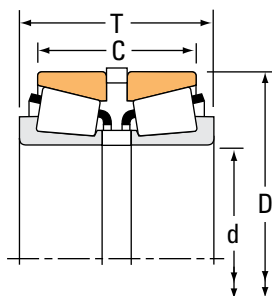
⁽⁵⁾Contact your Timken engineer for information on spacer configurations.

⁽⁶⁾These maximum fillet radii will be cleared by bearing corners.

TAPERED ROLLER BEARINGS

DOUBLE-ROW • TYPE 2S

TYPE 2S



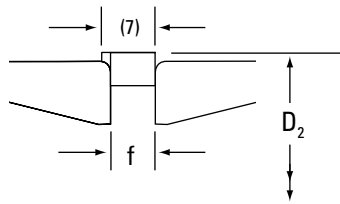
Bearing Dimensions				Load Ratings							
Bore d	O.D. D	Width ⁽¹⁾ T	Width C	Dynamic ⁽²⁾				Dynamic ⁽⁴⁾			
				C ₁₍₂₎	e	Factors ⁽³⁾ Y ₁	Y ₂	C ₉₀	C _{a90}	C ₉₀₍₂₎	Factors ⁽³⁾ K
mm in.	mm in.	mm in.	mm in.	N lbf				N lbf	N lbf	N lbf	
45.242 1.7812	73.431 2.8910	42.672 1.6800	35.052 1.3800	127000 28500	0.31	2.21	3.29	18900 4250	9870 2220	32900 7400	1.91
45.242 1.7812	77.788 3.0625	44.247 1.7420	34.722 1.3670	133000 29900	0.43	1.58	2.35	19800 4450	14500 3250	34400 7740	1.37
52.387 2.0625	92.075 3.6250	54.752 2.1556	45.227 1.7806	172000 38700	0.38	1.79	2.66	25700 5770	16600 3720	44700 10000	1.55
53.975 2.1250	88.900 3.5000	43.637 1.7180	32.522 1.2804	114000 25600	0.55	1.24	1.84	17000 3820	15900 3570	29500 6640	1.07
57.150 2.2500	112.712 4.4375	66.675 2.6250	53.975 2.1250	291000 65300	0.34	1.99	2.96	43300 9730	25100 5650	75400 16900	1.72
61.912 2.4375	110.000 4.3307	49.535 1.9502	43.185 1.7002	172000 38700	0.40	1.68	2.50	25600 5760	17600 3970	44600 10000	1.45
63.500 2.5000	112.712 4.4375	66.675 2.6250	53.975 2.1250	344000 77400	0.34	1.99	2.96	51300 11500	29800 6700	89300 20100	1.72
66.675 2.6250	112.712 4.4375	66.675 2.6250	53.975 2.1250	291000 65300	0.34	1.99	2.96	43300 9730	25100 5650	75400 16900	1.72
68.262 2.6875	110.000 4.3307	49.433 1.9462	43.083 1.6962	172000 38700	0.40	1.68	2.50	25600 5760	17600 3970	44600 10000	1.45
68.262 2.6875	110.000 4.3307	49.611 1.9532	43.261 1.7032	172000 38700	0.40	1.68	2.50	25600 5760	17600 3970	44600 10000	1.45
83.345 3.2813	125.412 4.9375	54.762 2.1560	43.652 1.7186	204000 45900	0.42	1.62	2.42	30400 6830	21600 4860	52900 11900	1.40
88.900 3.5000	121.442 4.7812	35.702 1.4056	27.762 1.0930	104000 23300	0.33	2.04	3.04	15400 3470	8730 1960	26800 6030	1.77

⁽¹⁾Overall width can vary depending on spacer selection. Contact your Timken engineer for more information.

⁽²⁾Based on 1×10^6 revolutions L_{10} life, for the ISO life-calculation method. $C_{1(2)}$ is the double-row radial value.

⁽³⁾Consult your Timken engineer for instructions on use or review the Timken Engineering Manual on timken.com/catalogs.

⁽⁴⁾Based on 90×10^6 revolutions L_{10} life, for The Timken Company life-calculation method. C_{90} and C_{a90} are radial and thrust values. $C_{90(2)}$ is the double-row radial value.



⁽⁷⁾Housing groove width with less than critical location =
 $f + 0.25 \text{ mm} \quad +0.10 \text{ mm}$
 $\quad \quad \quad -0.10 \text{ mm tolerance}$
 $f + 0.010 \text{ in.} \quad +0.004 \text{ in.}$
 $\quad \quad \quad -0.000 \text{ in. tolerance}$

Part Number				Dimensions					Bearing Weight
Inner	Outer	Inner Spacer ⁽⁵⁾	Outer Spacer ⁽⁵⁾	Shaft		Housing	Snap Ring Groove		
				Max Shaft Fillet Radius	Backing Shoulder Dia.	Backing Shoulder Dia.	D ₂	f ⁽⁷⁾	
				R ⁽⁶⁾	d _b	D _a			
				mm in.	mm in.	mm in.	mm in.	mm in.	
NP118297	NP422278	LM102949XB	K161783R	3.5 0.14	56.0 2.20	70.0 2.76	76.20 3.00	3.56 0.14	0.66 1.48
LM603049AS	LM603011	K109152R	K109151R	0.8 0.03	53.0 2.09	74.0 2.91	81.33 3.20	4.56 0.18	0.79 1.76
28584	28521	K107577R	K107578R	3.5 0.14	65.0 2.56	87.0 3.43	95.83 3.77	5.54 0.22	1.44 3.20
LM806649	LM806610	K114294R	K114295R	2.3 0.09	65.0 2.56	85.0 3.35	92.61 3.65	5.54 0.22	0.94 2.08
39580	39521	X3S-39580	K326057R	3.5 0.14	74.0 2.91	107.0 4.21	116.74 4.60	6.35 0.25	2.93 6.48
392	394A	K444667R	K444668R	0.8 0.03	70.0 2.76	105.0 4.13	116.10 4.57	5.54 0.22	1.84 4.08
39585P	39521P	K167544	K326057R	3.5 0.14	79.0 3.11	107.0 4.21	116.74 4.60	6.35 0.25	2.68 5.92
39590	39521	K326056R	K326057R	3.5 0.14	82.0 3.23	107.0 4.21	116.74 4.60	6.35 0.25	2.47 5.46
399A	394A	X5S-399A	XC914-SD	2.3 0.09	78.0 3.07	105.0 4.13	114.05 4.49	5.54 0.22	1.67 3.68
399A	394A	K143291	K143293R	2.3 0.09	78.0 3.07	105.0 4.13	114.05 4.49	5.61 0.22	1.65 3.63
27690	27620	K107581R	K107582R	3.5 0.14	96.0 3.78	120.0 4.72	130.07 5.12	3.96 0.16	2.24 4.91
LL217849	LL217810	LL217849XB	K143253R	1.5 0.06	97.0 3.82	117.0 4.61	126.14 4.97	5.54 0.22	1.11 2.43

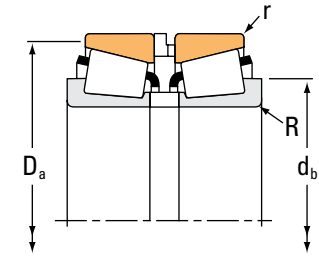
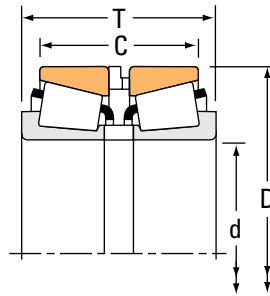
⁽⁵⁾ Contact your Timken engineer for information on spacer configurations.

⁽⁶⁾These maximum fillet radii will be cleared by bearing corners.

TAPERED ROLLER BEARINGS

DOUBLE-ROW • TYPE SR

TYPE SR



Bearing Dimensions				Load Ratings							
Bore d	O.D. D	Width ⁽¹⁾ T	Width C	Dynamic ⁽²⁾				Dynamic ⁽⁴⁾			
				C ₁₍₂₎	e	Factors ⁽³⁾ Y ₁	Y ₂	C ₉₀	C _{a90}	C ₉₀₍₂₎	Factors ⁽³⁾ K
mm in.	mm in.	mm in.	mm in.	N lbf				N lbf	N lbf	N lbf	
50.000 1.9685	82.000 3.2283	49.000 1.9291	39.425 1.5522	168000 37700	0.31	2.21	3.29	25000 5610	13000 2930	43500 9770	1.91
50.000 1.9685	90.000 3.5433	62.000 2.4409	51.438 2.0251	255000 57400	0.33	2.05	3.06	38000 8540	21400 4810	66200 14900	1.78
50.000 1.9685	105.000 4.1339	80.000 3.1496	63.540 2.5016	354000 79600	0.49	1.38	2.06	52700 11900	44000 9890	91800 20600	1.20
55.000 2.1654	90.000 3.5433	52.000 2.0472	42.504 1.6734	190000 42600	0.40	1.68	2.50	28200 6340	19400 4370	49100 11000	1.45
55.000 2.1654	90.000 3.5433	52.000 2.0472	40.475 1.5935	196000 44000	0.41	1.66	2.47	29100 6550	20300 4560	50800 11400	1.44
55.000 2.1654	95.000 3.7402	64.000 2.5197	52.418 2.0637	227000 51100	0.33	2.02	3.00	33800 7610	19400 4360	58900 13200	1.74
55.000 2.1654	110.000 4.3307	86.000 3.3858	71.415 2.8116	433000 97400	0.35	1.95	2.90	64500 14500	38300 8600	112000 25300	1.69
55.000 2.1654	110.000 4.3307	95.400 3.7558	80.815 3.1816	433000 97400	0.35	1.95	2.90	64500 14500	38300 8600	112000 25300	1.69
60.000 2.3622	95.000 3.7402	54.000 2.1260	43.491 1.7122	170000 38200	0.40	1.68	2.50	25300 5690	17400 3910	44000 9900	1.45
65.000 2.5591	105.000 4.1339	54.000 2.1260	42.515 1.6738	223000 50200	0.45	1.49	2.21	33200 7470	25800 5810	57900 13000	1.29
65.000 2.5591	110.000 4.3307	62.000 2.4409	50.489 1.9877	291000 65400	0.40	1.68	2.50	43300 9740	29800 6700	75400 17000	1.45
65.000 2.5591	110.000 4.3307	114.300 4.5000	102.718 4.0440	291000 65400	0.40	1.68	2.50	43300 9740	29800 6700	75400 17000	1.45
65.000 2.5591	120.000 4.7244	86.000 3.3858	71.402 2.8111	388000 87300	0.34	2.00	2.98	57800 13000	33400 7500	101000 22600	1.73
70.000 2.7559	110.000 4.3307	58.000 2.2835	46.519 1.8315	199000 44800	0.49	1.38	2.06	29700 6680	24800 5570	51700 11600	1.20
70.000 2.7559	115.000 4.5276	64.000 2.5197	51.507 2.0278	310000 69600	0.43	1.57	2.34	46100 10400	33900 7630	80300 18000	1.36
75.000 2.9528	115.000 4.5276	56.000 2.2047	43.502 1.7126	244000 54900	0.46	1.47	2.19	36400 8180	28600 6420	63400 14200	1.27

⁽¹⁾Overall width can vary depending on spacer selection. Contact your Timken engineer for more information.

⁽²⁾Based on 1×10^6 revolutions L_{10} life, for the ISO life-calculation method. $C_{1(2)}$ is the double-row radial value.

⁽³⁾Consult your Timken engineer for instructions on use or review the Timken Engineering Manual on timken.com/catalogs.

⁽⁴⁾Based on 90×10^6 revolutions L_{10} life, for The Timken Company life-calculation method. C_{90} and C_{a90} are radial and thrust values. $C_{90(2)}$ is the double-row radial value.

Part Number					Dimensions				Bearing Weight without Snap Ring
Inner	Outer	Inner Spacer ⁽⁵⁾	Outer Spacer ⁽⁵⁾	Snap Ring ⁽⁶⁾	Shaft		Housing		
					Max Shaft Fillet Radius	Backing Shoulder Dia.	Max Housing Fillet Radius	Backing Shoulder Dia.	
					R ⁽⁷⁾	d _b	r ^(l)	D _a	
					mm in.	mm in.	mm in.	mm in.	kg lbs.
JLM104948	JLM104910	LM104948XS	LM104910ES	K444653R	3.0 0.12	61.0 2.40	0.4 0.02	78.0 3.07	0.91 2.01
JM205149	JM205110	M205149XS	M205110ES	K516778R	3.0 0.12	63.0 2.48	0.5 0.02	85.0 3.35	1.56 3.44
JHM807045	JHM807012	HM807045XS	HM807012ES	K518781R	3.0 0.12	69.0 2.72	0.8 0.03	100.0 3.94	3.13 6.88
JLM506849	JLM506810	LM506849XS	LM506810ES	K516778R	1.5 0.06	63.0 2.48	0.5 0.02	86.0 3.39	1.15 2.57
X32011X	Y32011X	JXH5506A	JYH9006TSR	K527327R	1.5 0.06	65.0 2.56	0.3 0.01	86.5 3.41	1.20 2.66
JM207049	JM207010	M207049XS	M207010ES	K518779R	1.5 0.06	64.0 2.52	0.5 0.02	91.0 3.58	1.74 3.85
JH307749	JH307710	H307749XS	H307710ES	K518419R	3.0 0.12	71.0 2.80	0.8 0.03	104.0 4.09	3.55 7.81
JH307749	JH307710	H307749XR	H307710ER	K518419R	3.0 0.12	71.0 2.80	0.8 0.03	104.0 4.09	3.83 8.42
JLM508748	JLM508710	LM508748XS	LM508710ES	K518779R	5.0 0.20	75.0 2.95	0.5 0.02	91.0 3.58	1.26 2.77
JLM710949C	JLM710910	LM710949XS	LM710910ES	K518781R	3.0 0.12	78.0 3.07	0.4 0.02	100.5 3.96	1.61 3.53
JM511946	JM511910	M511946XS	M511910ES	K518419R	3.0 0.12	78.0 3.07	0.8 0.03	105.0 4.13	2.24 4.93
JM511946	JM511910	JXH6558A	JYH11058RSR	K518419R	3.0 0.12	78.0 3.07	0.8 0.03	105.0 4.13	3.69 8.12
JH211749	JH211710	H211749XS	H211710ES	K518771R	3.0 0.12	80.0 3.15	1.0 0.04	114.0 4.49	3.92 8.65
JLM813049	JLM813010	LM813049XS	LM813010ES	K518419R	1.0 0.04	78.0 3.07	0.5 0.02	105.0 4.13	1.88 4.11
JM612949	JM612910	M612949XS	M612910ES	K524105R	3.0 0.12	83.0 3.27	0.6 0.03	110.0 4.33	2.36 5.23
JLM714149	JLM714110	LM714149XS	LM714110ES	K524105R	3.0 0.12	88.0 3.46	0.5 0.02	110.5 4.35	1.87 4.12

⁽⁵⁾ Contact your Timken engineer for information on spacer configurations.

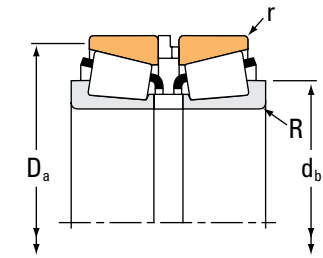
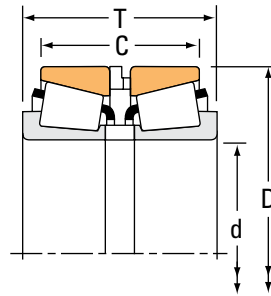
⁽⁶⁾ If a snap ring is used, the assembly cannot be lubricated through the outer race spacer.

⁽⁷⁾ These maximum fillet radii will be cleared by the bearing corners.

TAPERED ROLLER BEARINGS

DOUBLE-ROW • TYPE SR

TYPE SR



Bearing Dimensions				Load Ratings							
Bore d	O.D. D	Width ⁽¹⁾ T	Width C	Dynamic ⁽²⁾				Dynamic ⁽⁴⁾			
				C ₁₍₂₎	e	Factors ⁽³⁾ Y ₁	Y ₂	C ₉₀	C _{a90}	C ₉₀₍₂₎	Factors ⁽³⁾ K
mm in.	mm in.	mm in.	mm in.	N lbf				N lbf	N lbf	N lbf	
75.000 2.9528	120.000 4.7244	69.000 2.7165	57.000 2.2441	277000 62400	0.44	1.52	2.26	41300 9290	31400 7070	71900 16200	1.31
75.000 2.9528	145.000 5.7087	112.000 4.4094	93.400 3.6771	604000 136000	0.36	1.86	2.78	89900 20200	55700 12500	157000 35200	1.61
80.000 3.1496	125.000 4.9213	66.000 2.5984	51.500 2.0276	342000 77000	0.42	1.60	2.38	51000 11500	36900 8300	88800 20000	1.38
80.000 3.1496	130.000 5.1181	78.000 3.0709	64.452 2.5374	410000 92100	0.39	1.74	2.59	61000 13700	40600 9120	106000 23900	1.50
85.000 3.3465	130.000 5.1181	65.975 2.5974	53.491 2.1060	281000 63100	0.44	1.52	2.26	41800 9400	31800 7150	72800 16400	1.31
85.000 3.3465	140.000 5.5118	86.000 3.3858	70.470 2.7744	490000 110000	0.41	1.66	2.47	73000 16400	50900 11400	127000 28600	1.43
85.000 3.3465	140.000 5.5118	128.867 5.0735	113.337 4.4621	490000 110000	0.41	1.66	2.47	73000 16400	50900 11400	127000 28600	1.43
85.000 3.3465	150.000 5.9055	102.000 4.0157	85.390 3.3619	685000 154000	0.33	2.03	3.02	102000 22900	58100 13100	178000 39900	1.76
90.000 3.5433	145.000 5.7087	78.974 3.1092	62.489 2.4602	387000 87000	0.44	1.52	2.26	57700 13000	43900 9860	100000 22600	1.31
90.000 3.5433	155.000 6.1024	98.000 3.8583	80.314 3.1619	683000 153000	0.34	1.98	2.95	102000 22900	59400 13300	177000 39800	1.71
95.000 3.7402	150.000 5.9055	78.000 3.0709	61.466 2.4199	374000 84000	0.44	1.53	2.27	55700 12500	42100 9470	96900 21800	1.32
100.000 3.9370	155.000 6.1024	80.000 3.1496	63.417 2.4967	403000 90600	0.47	1.43	2.12	60000 13500	48600 10900	104000 23500	1.24
100.000 3.9370	160.000 6.2992	90.000 3.5433	71.412 2.8115	576000 130000	0.47	1.43	2.14	85800 19300	69100 15500	149000 33600	1.24
110.000 4.3307	165.000 6.4961	79.756 3.1401	62.413 2.4572	396000 88900	0.50	1.36	2.02	58900 13200	50100 11300	103000 23100	1.18
110.000 4.3307	180.000 7.0866	102.975 4.0541	84.364 3.3215	647000 145000	0.41	1.66	2.48	96300 21600	66900 15000	168000 37700	1.44
110.000 4.3307	180.000 7.0866	103.000 4.0551	84.364 3.3215	647000 145000	0.41	1.66	2.48	96300 21600	66900 15000	168000 37700	1.44

⁽¹⁾Overall width can vary depending on spacer selection. Contact your Timken engineer for more information.

⁽²⁾Based on 1×10^6 revolutions L_{10} life, for the ISO life-calculation method. $C_{1(2)}$ is the double-row radial value.

⁽³⁾Consult your Timken engineer for instructions on use or review the Timken Engineering Manual on timken.com/catalogs.

⁽⁴⁾Based on 90×10^6 revolutions L_{10} life, for The Timken Company life-calculation method. C_{90} and C_{a90} are radial and thrust values. $C_{90(2)}$ is the double-row radial value.

Part Number					Dimensions				Bearing Weight without Snap Ring
Inner	Outer	Inner Spacer ⁽⁵⁾	Outer Spacer ⁽⁵⁾	Snap Ring ⁽⁶⁾	Shaft		Housing		
					Max Shaft Fillet Radius	Backing Shoulder Dia.	Max Housing Fillet Radius	Backing Shoulder Dia.	
					R ⁽⁷⁾	d _b	r ^(l)	D _a	
					mm in.	mm in.	mm in.	mm in.	kg lbs.
JM714249	JM714210	M714249XS	M714210ES	K518771R	3.0 0.12	88.0 3.46	0.6 0.03	115.0 4.53	2.72 6.02
JH415647	JH415610	H415647XS	H415610ES	K524653R	3.0 0.12	94.0 3.70	0.8 0.03	139.0 5.47	8.02 17.70
X32016X	Y32016X	JXH8008AI	JYH12508TSR	K527332R	1.5 0.06	91.0 3.58	0.6 0.03	120.0 4.72	2.72 5.99
JM515649	JM515610	M515649XS	M515610ES	K524112R	3.0 0.12	94.0 3.70	0.6 0.03	125.0 4.92	3.62 8.00
JM716649	JM716610	M716649XS	M716610ES	K523970R	3.0 0.12	98.0 3.86	0.8 0.03	125.0 4.92	2.87 6.34
JHM516849	JHM516810	HM516849XS	HM516810ES	K518333R	3.0 0.12	100.0 3.94	1.0 0.04	134.0 5.28	4.76 10.51
JHM516849	JHM516810	HM516849XB	HM516810EB	K518333R	3.0 0.12	100.0 3.94	1.0 0.04	134.0 5.28	6.51 14.37
JH217249	JH217210	H217249XS	H217210ES	K518773R	3.0 0.12	101.0 3.98	1.3 0.05	142.0 5.59	7.05 15.53
JM718149	JM718110	M718149XS	M718110ES	K524653R	3.0 0.12	106.0 4.17	1.0 0.04	138.8 5.46	4.59 10.11
JHM318448	JHM318410	HM318448XS	HM318410ES	K516800R	3.0 0.12	106.0 4.17	0.8 0.03	148.0 5.83	6.97 15.33
JM719149	JM719113	M719149XS	M719113ES	K518773R	3.0 0.12	109.0 4.29	0.8 0.03	143.0 5.63	4.60 10.15
JM720249	JM720210	JXH10010A	M720210ES	K516800R	3.0 0.12	115.0 4.53	0.8 0.03	149.0 5.87	5.00 11.01
JHM720249	JHM720210	JXH10010A	HM720210ES	K525362R	3.0 0.12	117.0 4.61	0.8 0.03	153.9 6.06	6.31 13.91
JM822049	JM822010	JXH11010A	M822010ES	K524660R	3.0 0.12	125.0 4.92	0.8 0.03	159.0 6.26	5.29 11.70
JHM522649	JHM522610	HM522649XS	HM522610ES	K518334R	3.0 0.12	127.0 5.00	0.8 0.03	172.0 6.77	9.42 20.74
JHM522649	JHM522610	HM522649XE	HM522610ES	K518334R	3.0 0.12	127.0 5.00	0.8 0.03	172.0 6.77	9.40 20.68

⁽⁵⁾ Contact your Timken engineer for information on spacer configurations.

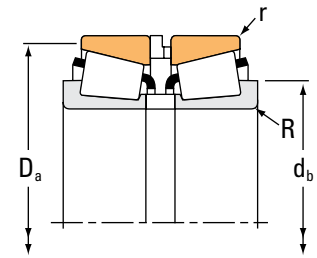
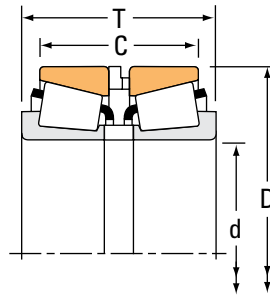
⁽⁶⁾ If a snap ring is used, the assembly cannot be lubricated through the outer race spacer.

⁽⁷⁾ These maximum fillet radii will be cleared by the bearing corners.

TAPERED ROLLER BEARINGS

DOUBLE-ROW • TYPE SR

TYPE SR



Bearing Dimensions				Load Ratings							
Bore d	O.D. D	Width ⁽¹⁾ T	Width C	Dynamic ⁽²⁾				Dynamic ⁽⁴⁾			
				C ₁₍₂₎	e	Factors ⁽³⁾ Y ₁	Y ₂	C ₉₀	C _{a90}	C ₉₀₍₂₎	Factors ⁽³⁾ K
mm in.	mm in.	mm in.	mm in.	N lbf				N lbf	N lbf	N lbf	
170.000 6.6929	240.000 9.4488	101.000 3.9764	82.278 3.2393	699000 157000	0.44	1.54	2.30	104000 23400	77900 17500	181000 40700	1.34
180.000 7.0866	250.000 9.8425	103.000 4.0551	82.288 3.2397	712000 160000	0.48	1.41	2.09	106000 23800	87200 19600	185000 41500	1.22
190.000 7.4803	260.000 10.2362	102.000 4.0157	82.263 3.2387	708000 159000	0.48	1.41	2.11	105000 23700	86200 19400	184000 41300	1.22

⁽¹⁾Overall width can vary depending on spacer selection. Contact your Timken engineer for more information.

⁽²⁾Based on 1×10^6 revolutions L_{10} life, for the ISO life-calculation method. $C_{1(2)}$ is the double-row radial value.

⁽³⁾Consult your Timken engineer for instructions on use or review the Timken Engineering Manual on timken.com/catalogs.

⁽⁴⁾Based on 90×10^6 revolutions L_{10} life, for The Timken Company life-calculation method. C_{90} and C_{a90} are radial and thrust values. $C_{90(2)}$ is the double-row radial value.

Part Number					Dimensions				Bearing Weight without Snap Ring
Inner	Outer	Inner Spacer ⁽⁵⁾	Outer Spacer ⁽⁵⁾	Snap Ring ⁽⁶⁾	Shaft		Housing		
					Max Shaft Fillet Radius	Backing Shoulder Dia.	Max Housing Fillet Radius	Backing Shoulder Dia.	
					R ⁽⁷⁾	d _b	r ⁽¹⁾	D _a	
					mm in.	mm in.	mm in.	mm in.	kg lbs.
JM734449	JM734410	M734449XS	M734410ES	K518335R	3.0 0.12	185.0 7.28	1.5 0.06	232.0 9.13	13.16 29.00
JM736149	JM736110	M736149XS	M736110ES	K525377R	3.0 0.12	196.0 7.72	1.0 0.04	242.6 9.55	14.02 30.90
JM738249	JM738210	M738249XS	M738210ES	K525378R	3.0 0.12	206.0 8.11	1.0 0.04	252.0 9.92	14.41 31.75

⁽⁵⁾ Contact your Timken engineer for information on spacer configurations.

⁽⁶⁾ If a snap ring is used, the assembly cannot be lubricated through the outer race spacer.

⁽⁷⁾ These maximum fillet radii will be cleared by the bearing corners.

TAPERED ROLLER THRUST BEARINGS

Overview: Timken® thrust bearings are built to handle high thrust loads and heavy shock. The distinctive on-apex design characteristic of tapered roller thrust bearings ensures true rolling motion, which reduces roller sliding and provides a smoother, cooler-running bearing than other thrust types. Available in a wide range of sizes and design styles, these bearings fit many types of machinery in the industrial and automotive markets.

- **Bore Sizes:** 16.1 mm - 1550.0 mm (0.6337 in. - 61.0236 in.)
- **Industries:** Aggregate, rubber and plastics, metals, oil, gas and power generation.
- **Applications:** Cone crushers, crane hooks, oil well swivels, top drives, extruders, pulverizer drives, rolling mills, machine tool spindles and tables, drilling rig hydraulic heads, gear boxes and pre-heater fans.
- **Benefits:** High performance and application flexibility versus other non-tapered bearing types. Large range of product offerings.



TAPERED ROLLER THRUST BEARINGS

Timken tapered roller thrust bearings include conical rollers for true rolling motion. These bearings are engineered so that the rollers and raceway converge at a common apex point, which is on the center line of the bearing. Seating force between the rib and roller helps provide positive roller guidance.

Timken manufactures several types of heavy-duty tapered roller thrust bearings: standard (TTHD), V-flat (TTHDFL) and self-aligning V-flat (TTVS). Timken also offers TTSP and TTC, light-duty thrust bearings designed for oscillating applications.

TTHD

The TTHD design has an identical pair of hardened and ground steel rings with tapered raceways. Because both rings have the same bore and O.D., housings should be designed to clear the O.D. of rotating rings and shafts stepped to clear the bore of stationary rings. Controlled-contour tapered rollers are used and equally spaced by a cage. All components are separable. Most TTHD bearings are supplied with case-carburized components, which are well-suited for applications where extremely high thrust loads and heavy shock may be encountered. For very low-speed applications with unusually high loading, TTHD bearings can be supplied with a full complement of rollers. Extensively used in numerous applications, including oil well swivels, top drives, pulp refiners, extruders and gearboxes. Applications for full-complement bearings should be reviewed by your Timken engineer to help ensure selection of the proper bearing.



Fig. 34. Type TTHD.

TTHDFL

The TTHDFL combines the outstanding features of tapered and cylindrical roller bearings, offering the highest possible capacity of any thrust bearing of its size. The V-flat design includes one flat ring and one ring having a tapered raceway matching the rollers. These bearings maximize dynamic and static capacity within a given envelope. The design was originally developed for screwdown applications in metal rolling mills. They also have been highly successful in heavily loaded extruders, cone crushers, top drives and other applications where a wide range of operating conditions are found. Most sizes utilize pin-type cages with hardened pins through the center of the rollers, allowing closer spacing of the rollers to maximize capacity. Smaller sizes have brass cages designed for unidirectional retention of rollers.

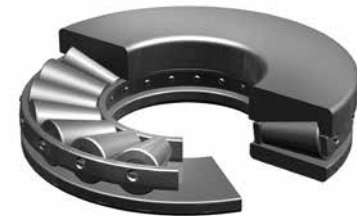


Fig. 35. Type TTHDFL.

TTVS

The TTVS design employs the same basic roller and raceway design as the TTHDFL, except the lower ring is in two pieces. The contacting faces of the lower ring are spherically ground, permitting self-alignment under conditions of initial misalignment. TTVS bearings should not be used if dynamic misalignment (changing under load) is expected. These bearings are found in cone crushers, extruders, gear drives and pulp refiners.



Fig. 36. Type TTVS.

TTSP

Type TTSP thrust bearing is made up of two tapered thrust races, rollers, cage and an outside retainer which holds the components together during shipping and installation. TTSP bearings are light-duty thrust bearings and are used extensively in the steering pivot positions of automotive and other industrial applications.



Fig. 37. Type TTSP.

TTC, TTCS, TTCL

The types TTC, TTCS and TTCL thrust bearings consist of two tapered thrust races, rollers, and an outside retainer, but do not have a cage. The outside retainer holds the assembly together for shipping and installation. Types TTC, TTCS and TTCL bearings are thrust bearings specifically designed for oscillating applications. The retainer construction varies between types.



Fig. 38. Type TTC.



Fig. 39. Type TTCS.



Fig. 40. Type TTCL.

TAPERED STANDARD THRUST BEARING NOMENCLATURE

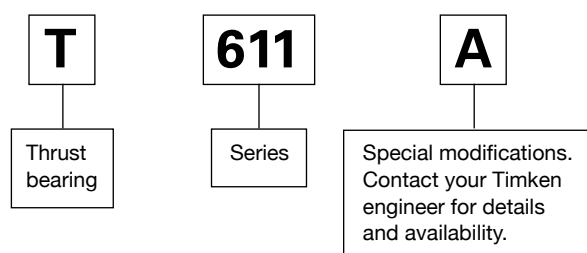


Fig. 41. Tapered thrust bearing nomenclature.

SPECIAL PART NUMBERS

Timken thrust bearings follow a unique part-numbering system with three main components. Since many thrust bearings are designed for a specific application it is common to use special part numbers.

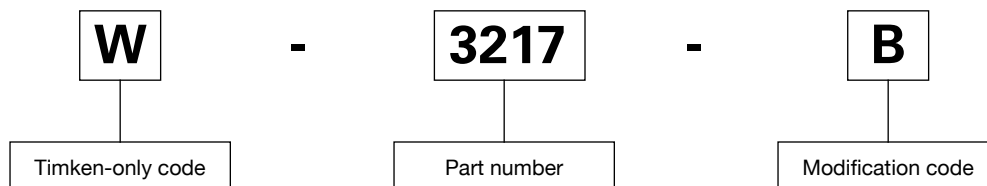
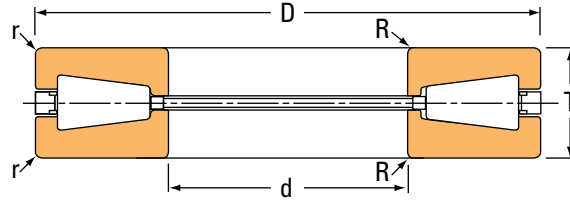


Fig. 42. Special part number nomenclature.

TYPE TTHD



Part Number		Dimensions					Ratings		Bearing Weight
Bearing	Cage Type	Bore	Outside Diameter	Width	Max. Shaft Fillet Radius	Housing Fillet Radius ⁽¹⁾	Static	Dynamic ⁽²⁾	
		d	D	T	R	r	C ₀	C _{a90}	
		mm in.	mm in.	mm in.	mm in.	mm in.	N lbf	N lbf	kg lbs.
T135	Machined	34.925 1.3750	76.200 3.0000	15.875 0.6250	1.5 0.06	1.5 0.06	317000 71200	31700 7130	0.37 0.82
T1750	Machined	44.450 1.7500	84.734 3.3360	18.258 0.7188	2.3 0.09	2.3 0.09	434000 97700	42000 9460	0.49 1.07
T200A	Machined	50.800 2.0000	109.538 4.3125	22.225 0.8750	2.3 0.09	2.3 0.09	804000 181000	73100 16400	1.04 2.30
T311	Machined	76.200 3.0000	161.925 6.3750	33.338 1.3215	3.3 0.13	3.3 0.13	1760000 395000	152000 34200	3.47 7.66
T311F	Cageless	76.200 3.0000	161.925 6.3750	33.338 1.3215	3.3 0.13	3.3 0.13	2440000 545000	1250000 281000	3.54 7.81
T451	Machined	114.300 4.5000	250.825 9.8750	53.975 2.1250	4.0 0.16	4.0 0.16	4380000 985000	352000 79100	14.20 31.31
T511	Machined	127.000 5.0000	266.700 10.5000	58.738 2.3125	4.8 0.19	4.8 0.19	4580000 1030000	372000 83600	17.03 37.56
T9250FA	Cageless	139.700 5.5000	546.100 21.5000	127.000 5.0000	* *	16.0 0.63	31200000 7050000	16050000 3600000	191.33 421.80
T611	Machined	152.400 6.0000	317.500 12.5000	69.850 2.7500	6.4 0.25	6.4 0.25	6660000 1500000	526000 118000	28.35 62.50
T661	Machined	168.275 6.6250	304.800 12.0000	69.850 2.7500	6.4 0.25	6.4 0.25	5340000 1200000	442000 99300	23.53 51.87
T691	Machined	174.625 6.8750	358.775 14.1250	82.550 3.2500	6.4 0.25	6.4 0.25	7870000 1770000	620000 139000	43.16 95.15
T811	Machined	203.200 8.0000	419.100 16.5000	92.075 3.6250	9.7 0.38	9.7 0.38	11400000 2560000	869000 195000	65.48 144.33
T911	Machined	228.600 9.0000	482.600 19.0000	104.775 4.1250	* *	11.2 0.44	15200000 3420000	1140000 256000	98.25 216.61
T9250F	Cageless	234.950 9.2500	546.100 21.5000	127.000 5.0000	* *	16.0 0.63	31200000 7050000	16050000 3600000	164.84 363.40
T1421	Cageless	355.600 14.0000	533.400 21.0000	101.600 4.0000	* *	6.4 0.25	17200000 3870000	8000000 1790000	82.88 182.72
T16021	Machined	406.400 16.0000	711.200 28.0000	146.050 5.7500	* *	9.7 0.38	29000000 6530000	2130000 480000	259.63 572.38

⁽¹⁾These maximum fillet radii will be cleared by the bearing corners.

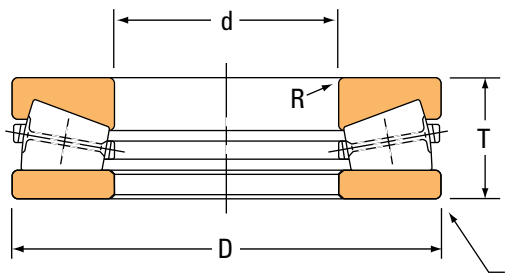
⁽²⁾Dynamic rating C_{a90} is for breaker block on cageless designer.

^(*)Contact your Timken engineer for details.

TAPERED ROLLER BEARINGS

THRUST • TYPE TTHDFL

TYPE TTHDFL



Part Number		Dimensions					Ratings		Bearing Weight
Bearing	Cage Type	Bore	Outside Diameter	Width	Shaft Fillet Radius	Housing Fillet Radius ⁽¹⁾	Static	Dynamic	
		d	D	T	R	r	C ₀	C ₉₀	
		mm in.	mm in.	mm in.	mm in.	mm in.	N lbf	N lbf	kg lbs.
F-3167-B	Machined	101.575 3.9990	215.875 8.4990	46.038 1.8125	2.5 0.10	2.5 0.10	1570000 353000	228000 51300	9.30 20.50
T4920-T4921	Machined	124.993 4.9210	185.738 7.3125	25.400 1.0000	1.5 0.06	1.5 0.06	1250000 282000	93300 21000	2.36 5.19
W-3217-B	Machined	127.000 5.0000	266.700 10.5000	58.357 2.2975	3.6 0.14	3.6 0.14	2570000 578000	350000 78800	19.00 41.00
S-4055-C	Machined	149.974 5.9045	299.720 11.8000	89.700 3.5315	3.0 0.12	3.0 0.12	3350000 754000	480000 108000	36.00 79.00
G-3304-B	Pin	168.275 6.6250	304.800 12.0000	69.850 2.7500	6.4 0.25	6.4 0.25	3730000 839000	495000 111000	25.90 57.00
T660V	Cageless	168.275 6.6250	304.800 12.0000	69.850 2.7500	6.4 0.25	6.4 0.25	7090000 1590000	524000 118000	23.10 50.91
W-3218-B	Pin	177.800 7.0000	368.300 14.5000	82.169 3.2350	6.1 0.24	6.1 0.24	6270000 1410000	762000 171000	49.00 109.00
T7010V	Pin	177.800 7.0000	368.300 14.5000	82.550 3.2500	7.9 0.31	7.9 0.31	10900000 2450000	775000 174000	43.86 96.68
F-3094-C	Machined	228.575 8.9990	431.749 16.9980	88.900 3.5000	5.1 0.20	5.1 0.20	7120000 1600000	887000 199000	71.70 158.00
T9011	Pin	228.600 9.0000	482.600 19.0000	104.775 4.1250	1.5 0.06	11.2 0.44	18500000 4170000	1270000 285000	94.85 209.13
DX121944	Pin	234.950 9.2500	21.500 21.5000	127.000 5.0000	1.5 0.06	3.3 0.13	28100000 6320000	2230000 500000	161.88 356.88
I-2077-C	Machined	253.975 9.9990	508.000 20.0000	95.250 3.7500	6.4 0.25	6.4 0.25	10000000 2260000	1170000 264000	110.20 243.00
R-2927-C	Pin	254.000 10.0000	508.000 20.0000	107.950 4.2500	4.8 0.19	4.8 0.19	12100000 2720000	1440000 324000	123.40 272.00
T10100V	Pin	256.540 10.1000	546.100 21.5000	164.719 6.4850	1.5 0.06	6.4 0.25	28300000 6370000	2070000 465000	205.09 452.15
G-3224-C	Pin	256.540 10.1000	546.100 21.5000	165.100 6.5000	6.1 0.24	6.1 0.24	14900000 3350000	2050000 461000	227.20 501.00
S-4077-C	Pin	259.999 10.2362	479.948 18.8956	132.080 5.2000	4.8 0.19	4.8 0.19	8980000 2020000	1220000 275000	126.50 279.00
T11000	Pin	279.400 11.0000	601.675 23.6880	136.525 5.3750	1.5 0.06	11.2 0.44	32200000 7240000	2090000 469000	201.12 443.40
C-8091-C	Pin	279.400 11.0000	603.250 23.7500	136.140 5.3600	11.2 0.44	4.8 0.19	1770000 3980000	2050000 459000	231.00 508.00

⁽¹⁾These maximum fillet radii will be cleared by the bearing corners.

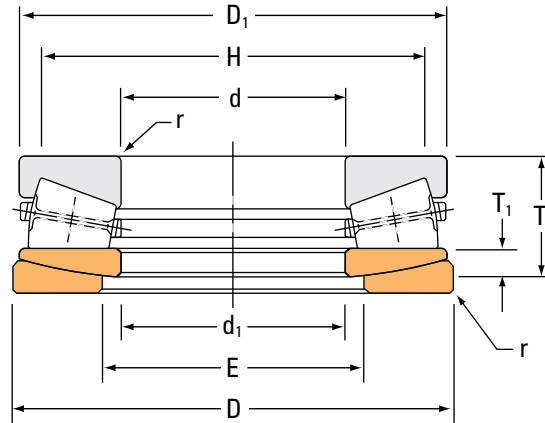
Continued on the next page.

Part Number		Dimensions				Ratings			Bearing Weight
Bearing	Cage Type	Bore	Outside Diameter	Width	Shaft Fillet Radius	Housing Fillet Radius ⁽¹⁾	Static	Dynamic	
		d	D	T	R	r	C ₀	C _{a90}	
		mm in.	mm in.	mm in.	mm in.	mm in.	N lbf	N lbf	kg lbs.
G-3272-C	Pin	304.775 11.9990	609.600 24.0000	113.792 4.4800	6.4 0.25	6.4 0.25	17800000 3990000	1910000 430000	190.90 421.00
E-1994-C	Pin	304.800 12.0000	673.100 26.5000	171.069 6.7350	7.6 0.30	7.6 0.30	22700000 5100000	2850000 710000	347.80 767.00
F-3090-A	Pin	304.800 12.0000	736.600 29.0000	279.020 10.9850	9.1 0.36	9.1 0.36	28000000 6300000	4430000 998000	729.00 1607.00
I-2060-C	Machined	368.541 14.5095	609.156 23.9825	120.269 4.7350	9.7 0.38	11.2 0.38	11800000 2640000	1510000 340000	176.00 388.00
T15500	Machined	393.700 15.5000	495.300 19.5000	44.450 1.7500	3.3 0.13	3.3 0.13	6900000 1550000	373000 83700	* *
T15501	Polymer	393.700 15.5000	495.300 19.5000	44.450 1.7500	3.3 0.13	3.3 0.13	6900000 1550000	373000 83700	* *
B-8350-C	Machined	406.400 16.0000	711.200 28.0000	167.084 6.5781	9.1 0.36	9.1 0.36	19900000 4480000	2670000 599000	356.50 786.00
F-3163-C	Pin	406.400 16.0000	712.394 28.0470	146.050 5.7500	7.6 0.30	7.6 0.30	19300000 4350000	2380000 537000	303.40 669.00
F-3131-G	Pin	431.800 17.0000	863.600 34.0000	228.219 8.9850	10.2 0.40	10.2 0.40	37700000 8480000	4870000 1100000	774.60 1708.00
DX948645	Pin	457.200 18.0000	914.400 36.0000	181.044 7.1277	6.4 0.25	6.4 0.25	70100000 15800000	5422000 1219000	597.87 1318.10
DX175273	Pin	457.200 18.0000	965.200 38.0000	198.232 7.8044	6.4 0.25	6.4 0.25	18000000 4040000	5730000 1290000	742.59 1637.12
A-6096-C	Machined	508.000 20.0000	990.600 39.0000	196.850 7.7500	12.7 0.50	12.7 0.50	41500000 9320000	4330000 975000	882.50 1946.00
T20751	Polymer	527.050 20.7500	635.000 25.0000	44.450 1.7500	3.3 0.13	3.3 0.13	7750000 1740000	357000 80200	25.82 56.92
F-3093-A	Pin	558.800 22.0000	1066.800 42.0000	285.370 11.2350	10.2 0.40	10.2 0.40	49400000 11100000	7260000 1630000	1405.00 3097.00
F-3172-C	Machined	711.200 28.0000	965.200 38.0000	127.000 5.0000	4.8 0.19	4.8 0.19	19600000 4400000	2250000 506000	354.20 781.00
H-2054-G	Pin	711.200 28.0000	990.600 39.0000	190.119 7.4850	10.2 0.40	10.2 0.40	28000000 6300000	3680000 830000	460.00 1013.00
T30620	Machined	777.697 30.6180	889.000 35.0000	47.625 1.8750	3.3 0.13	3.3 0.13	11500000 2580000	442000 99300	45.71 100.79
D-2864-C	Pin	825.424 32.4970	1168.400 46.0000	127.000 5.0000	14.2 0.56	14.2 0.56	44100000 9920000	4040000 907000	549.70 1212.00
T45750	Machined	1162.050 45.7500	1282.700 50.5000	52.388 2.0625	3.3 0.13	3.3 0.13	19000000 4280000	618000 139000	79.69 175.66
F-3067-C	Machined	1219.998 48.0314	1574.869 62.0027	177.800 7.0000	6.4 0.25	6.4 0.25	49900000 11200000	5680000 1280000	1173.20 2587.00
T53250	Machined	1352.550 53.2500	1473.200 58.0000	52.375 2.0620	3.3 0.13	3.3 0.13	21100000 4750000	652000 146000	92.74 204.48
NP552714	Cageless	1549.999 61.0236	105.000 67.1260	60.000 2.3622	1.5 0.06	6.4 0.25	59400000 13400000	1600000 360000	149.16 328.85

⁽¹⁾Maximum shaft or housing fillet radius that bearing corners will clear.

^(*)Contact your Timken engineer for details.

TYPE TTVS



Part Number	Dimensions									Ratings		Bearing Weight
	Bearing			Rings			Shoulder Dia.		Housing	Static	Dynamic	
Bearing	Bore	O.D.	Width	Thickness	Small Dia. O.D.	Large Bore I.D.	Housing Max.	Shaft Min.	Fillet ⁽¹⁾ Radius Max.	C ₀	C _{a90}	
	d	D	T	T ₁	D ₁	d ₁	E	H	r	N lbf	N lbf	kg lbs.
	mm in.	mm in.	mm in.	mm in.	mm in.	mm in.	mm in.	mm in.	mm in.			
B-7976-C	184.150 7.2500	406.400 16.0000	203.200 8.0000	66.680 2.6250	404.810 15.9380	187.320 7.3750	228.6 9.00	346.1 13.62	6.1 0.24	7650000 1720000	1180000 264000	157.40 347.00
B-8824-C	199.374 7.8730	399.948 15.7460	121.841 4.7969	36.400 1.4330	396.880 15.6250	203.200 8.0000	240.5 9.47	358.8 14.12	4.1 0.16	7020000 1580000	931000 209000	86.20 190.00
E-2004-C	228.600 9.0000	482.549 18.9980	158.750 6.2500	44.910 1.7680	479.550 18.8800	231.780 9.1250	282.6 11.12	419.1 16.50	4.8 0.19	10900000 2440000	1520000 342000	170.10 375.00
H-1685-C	241.300 9.5000	488.899 19.2480	152.400 6.0000	57.150 2.2500	482.600 19.0000	242.090 9.5310	279.4 11.00	431.8 17.00	6.1 0.24	9940000 2240000	1290000 290000	162.80 359.00
W-3120-C	253.975 9.9990	508.000 20.0000	215.900 8.5000	61.910 2.4370	504.820 19.8750	285.750 11.2500	317.5 12.50	425.4 16.75	10.2 0.40	9770000 2200000	1560000 350000	250.80 553.00
P-1739-C	304.800 12.0000	609.600 24.0000	215.900 8.5000	61.910 2.4370	608.010 23.9380	307.980 12.1250	349.2 13.75	536.6 21.12	7.6 0.30	17800000 4010000	2590000 586000	359.60 793.00
N-2827-G	355.600 14.0000	660.400 26.0000	254.000 10.0000	76.200 3.0000	657.220 25.8750	358.780 14.1250	412.8 16.25	577.8 22.75	10.2 0.40	18600000 4180000	2880000 646000	483.00 1065.00
B-8424-C	406.400 16.0000	869.950 34.2500	241.300 9.5000	82.550 3.2500	887.410 34.9380	438.150 17.2500	463.6 18.25	803.3 31.62	16.5 0.65	39000000 8770000	4590000 1030000	858.00 1892.00

⁽¹⁾These maximum fillet radii will be cleared by the bearing corners.

TYPE TTSP

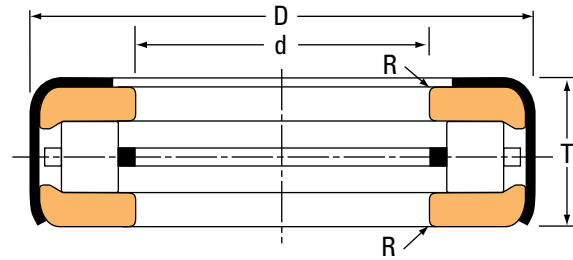


Fig. A.

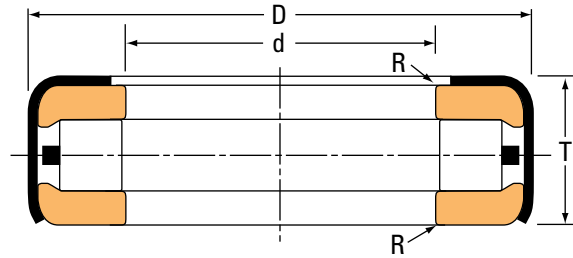


Fig. B.

Part Number		Fig.	Dimensions				Steering Pivot Rating	Bearing Weight	Remarks
No Oil Holes In Retainer	Oil Holes In Retainer		Bore	Outside Diameter	Width	Shaft Fillet Radius			
			d	D	T	R			
			mm in.	mm in.	mm in.	mm in.	N lbf	kg lbs.	
T63	T63W	A	16.129 0.6350	41.275 1.6250	12.700 0.5000	0.8 0.03	11100 2500	0.08 0.18	
T76	T76W	A	19.304 0.7600	41.275 1.6250	13.487 0.5310	0.8 0.03	11100 2500	0.08 0.18	
T77	T77W	A	19.304 0.7600	41.275 1.6250	12.700 0.5000	0.8 0.03	11100 2500	0.07 0.15	
T82	T82W	A	20.879 0.8220	41.275 1.6250	13.487 0.5310	0.8 0.03	11100 2500	0.07 0.15	
T86		A	20.257 0.7975	39.688 1.5625	14.288 0.5625	1.3 0.05	10700 2400	0.07 0.15	
T88	T88W	A	22.479 0.8850	48.021 1.8906	15.088 0.5940	0.8 0.03	17300 3890	0.11 0.24	
T89		A	22.479 0.8850	48.021 1.8906	15.875 0.6250	0.8 0.03	17350 3900	0.12 0.26	
T92		B	23.825 0.9380	44.958 1.7700	13.487 0.5310	0.8 0.03	11950 2690	* *	T92 has two bores, other bore = 24.054 mm (0.9470 in.)
T93		A	24.054 0.9470	44.958 1.7700	13.487 0.5310	0.8 0.03	11950 2690	0.09 0.2	
T94	T94W	A	24.054 0.9470	48.021 1.8906	15.088 0.5940	0.8 0.03	17350 3900	0.11 0.24	
T95	T95W	A	24.130 0.9500	50.800 2.0000	15.875 0.6250	0.8 0.03	18600 4200	0.13 0.29	
T101	T101W	A	25.654 1.0100	50.800 2.0000	15.875 0.6250	0.8 0.03	18600 4200	0.13 0.29	
T101X		A	25.146 0.9900	50.800 2.0000	15.875 0.6250	0.8 0.03	18600 4200	* *	T101X has two bores, other bore = 24.654 mm (1.0100 in.)

(*)Contact your Timken engineer for details.

Continued on the next page.

TAPERED ROLLER BEARINGS

THRUST • TYPE TTSP

TYPE TTSP – continued

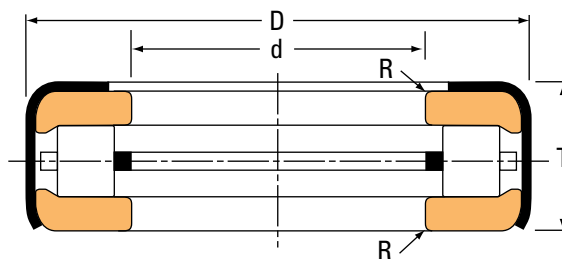


Fig. A.

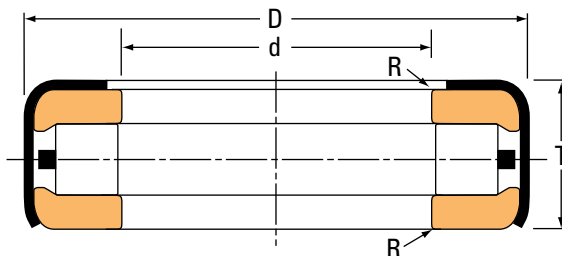


Fig. B.

Part Number		Fig.	Dimensions				Steering Pivot Rating	Bearing Weight	Remarks
No Oil Holes In Retainer	Oil Holes In Retainer		Bore	Outside Diameter	Width	Shaft Fillet Radius			
			d	D	T	R			
			mm in.	mm in.	mm in.	mm in.	N lbf	kg lbs.	
T102R		A	25.654 1.0100	50.800 2.0000	16.916 0.6660	0.8 0.03	18600 4200	* *	T102 has extended retainer. Contact Timken engineer for details.
T104	T104W	A	26.289 1.0350	50.800 2.0000	15.875 0.6250	0.8 0.03	18600 4200	0.13 0.29	
T105		A	25.654 1.0100	50.800 2.0000	15.875 0.6250	0.8 0.03	18600 4200	* *	T105 has two bores, other bore = 27.299 mm (1.0720 in.).
T107	T107W	A	27.299 1.0720	50.800 2.0000	15.875 0.6250	0.8 0.03	18600 4200	0.12 0.26	
T110	T110W	A	28.829 1.1350	53.188 2.0940	15.875 0.6250	0.8 0.03	20000 4500	0.14 0.31	
T113	T113W	A	28.829 1.1350	55.562 2.1875	15.875 0.6250	0.8 0.03	20000 4500	0.15 0.33	
T114	T114W	A	25.654 1.0100	55.562 2.1875	15.875 0.6250	0.8 0.03	20000 4500	* *	T114 and T114W have two bores, other bore = 28.829 mm (1.1350 in.).
T114X		B	28.829 1.1350	50.800 2.0000	15.875 0.6250	0.8 0.03	20000 4500	* *	T114X has two cages and two bores, other bore = 29.261 mm (1.1520 in.).
T119	T119W	A	30.416 1.1975	55.562 2.1875	15.875 0.6250	0.8 0.03	20000 4500	0.15 0.33	
T120		B	30.416 1.1975	54.745 2.1553	11.430 0.4500	0.8 0.03	16500 3710	0.11 0.24	
T121		A	30.716 1.2093	55.562 2.1875	15.875 0.6250	0.8 0.03	20000 4500	0.16 0.35	
T126	T126W	A	32.004 1.2600	55.562 2.1875	15.875 0.6250	0.8 0.03	20000 4500	0.14 0.31	
T126A	T126AW	A	32.004 1.2600	55.562 2.1875	15.875 0.6250	0.8 0.03	20000 4500	0.14 0.31	T126A - two cages.

(*)Contact your Timken engineer for details.

Continued on the next page.

Part Number		Fig.	Dimensions				Steering Pivot Rating	Bearing Weight	Remarks
No Oil Holes In Retainer	Oil Holes In Retainer		Bore	Outside Diameter	Width	Shaft Fillet Radius			
			d	D	T	R			
			mm in.	mm in.	mm in.	mm in.	N lbf	kg lbs.	
T139	T139W	A	35.179 1.3850	58.738 2.3125	15.875 0.6250	0.8 0.03	21400 4800	0.15 0.33	
T139KP		A	35.179 1.3850	58.738 2.3125	15.875 0.6250	0.8 0.03	21400 4800	0.15 0.33	Races are cadmium plated.
T142	T142W	A	35.179 1.3850	62.708 2.4688	19.431 0.7650	0.8 0.03	22400 5050	0.23 0.51	
T149	T149W	A	38.303 1.5080	65.883 2.5938	19.431 0.7650	0.8 0.03	23600 5300	0.24 0.53	
T158		A	40.234 1.5840	65.883 2.5938	19.431 0.7650	0.8 0.03	23600 5300	0.23 0.51	
T199	T199W	A	51.054 2.0100	74.612 2.9375	15.875 0.6250	0.8 0.03	26000 5850	0.2 0.44	
T309	T309W	A	78.583 3.0938	102.395 4.0313	15.875 0.6250	0.8 0.03	35400 8000	0.29 0.64	
T387	T387W	A	96.425 3.8750	127.000 5.0000	17.463 0.7650	0.8 0.03	43000 9700	0.5 1.1	
T484		A	123.012 4.8430	152.400 6.0000	17.463 0.6875	0.8 0.03	47500 10600	0.63 1.39	
T581		A	147.638 5.8125	177.800 7.0000	17.463 0.6875	0.8 0.03	51500 11600	0.89 1.96	
T1760		SPCL ⁽¹⁾	44.623 1.7568	76.200 3.0000	10.922 0.4300	0.8 0.03	31600 7100	0.18 0.4	

⁽¹⁾SPCL = special, not shown.

TYPE TTC, TTCS, TTCL



TTC



TTCS



TTCL

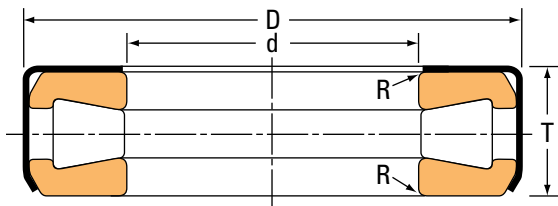


Fig. C. Type TTC.

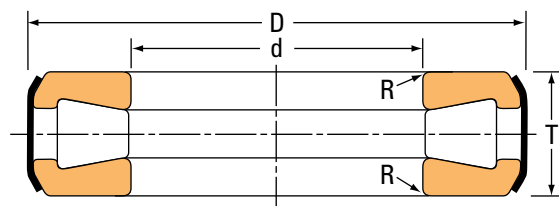


Fig. D. Type TTCS.

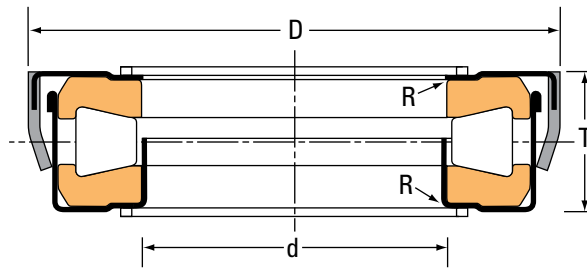


Fig. E. Type TTCL.

Part Number		Dimensions					Steering Pivot Rating	Bearing Weight	Remarks
No Oil Holes In Retainer	Oil Holes In Retainer	Fig.	Bore d	Outside Diameter D	Width T	Shaft Fillet Radius R			
			mm in.	mm in.	mm in.	mm in.	N lbf	kg lbs.	
T127	T127W	C	32.004 1.2600	66.675 2.6250	19.446 0.7656	0.8 0.03	42200 9450	0.31 0.68	
T128		D	32.004 1.2600	66.675 2.6250	18.654 0.7344	0.8 0.03	42200 9450	0.29 0.64	
T130		C	27.102 1.0670	66.675 2.6250	19.446 0.7656	0.8 0.03	42200 9450	0.34 0.75	
T136		D	35.179 1.3850	66.675 2.6250	18.654 0.7344	0.8 0.03	42200 9450	0.28 0.62	
T138	T138W	C	35.179 1.3850	66.675 2.6250	19.446 0.7656	0.8 0.03	42200 9450	0.30 0.66	
T138XS		SPCL ⁽¹⁾	35.179 1.3850	66.675 2.6250	19.446 0.7656	0.8 0.03	42200 9450	* *	T138XS has two bores, other bore = 35.387 mm (1.3972 in.).

⁽¹⁾SPCL = special, not shown.

^(*)Contact your Timken engineer for details.

Continued on the next page.

Part Number			Dimensions				Steering Pivot Rating	Bearing Weight	Remarks
No Oil Holes In Retainer	Oil Holes In Retainer	Fig.	Bore d	Outside Diameter D	Width T	Shaft Fillet Radius R			
			mm in.	mm in.	mm in.	mm in.	N lbf	kg lbs.	
T144	T144W	C	36.754 1.4470	66.675 2.6250	19.446 0.7656	1.5 0.06	42200 9450	0.29 0.64	
T144XA		SPCL ⁽¹⁾	36.754 1.4470	66.675 2.6250	19.446 0.7656	1.5 0.06	42200 9450	* *	T144XA has two bores, other bore = 37.137 mm (1.4621 in.).
T151	T151W	C	38.354 1.5100	72.619 2.8590	21.433 0.8438	0.8 0.03	47000 10600	0.37 0.82	
T152		D	38.354 1.5100	72.619 2.8590	20.638 0.8125	0.8 0.03	47000 10600	0.35 0.77	
T157	T157W	C	39.954 1.5730	72.619 2.8590	21.433 0.8438	0.8 0.03	47000 10600	0.37 0.82	
T163	T163W	C	41.529 1.6350	72.619 2.8590	21.433 0.8438	0.8 0.03	47000 10600	0.35 0.77	
T163X	T163XW	C	41.529 1.6350	72.619 2.8590	21.433 0.8438	2.0 0.80	47000 10600	0.35 0.77	
T169	T169W	C	43.104 1.6970	82.956 3.2660	23.812 0.9375	0.8 0.03	64000 14300	0.55 1.21	
T176	T176W	C	44.704 1.7600	82.956 3.2660	23.812 0.9375	0.8 0.03	64000 14300	0.54 1.19	
T177		C	45.000 1.7717	73.000 2.8740	20.000 0.7874	0.8 0.03	47500 10700	0.32 0.71	
T177A		C	45.484 1.7907	73.000 2.8740	20.000 0.7874	0.8 0.03	47500 10700	0.33 0.73	
T177XA		SPCL ⁽¹⁾	45.000 1.7717	73.127 2.8790	20.000 0.7874	0.8 0.03	47500 10700	* *	T177XA has two bores, other = 45.484 mm (1.7907 in.).
T177S		E	45.000 1.7717	74.500 2.9331	20.221 0.7961	0.8 0.03	47500 10700	0.35 0.77	
T178		C	40.401 1.5906	73.000 2.8740	19.000 0.7480	0.8 0.03	47500 10700	* *	
T182	T182W	C	46.279 1.8220	82.956 3.2660	23.812 0.9375	0.8 0.03	64000 14300	0.52 1.15	
T188	T188W	C	47.879 1.8850	82.956 3.2660	23.812 0.9375	0.8 0.03	64000 14300	0.52 1.15	
T189	T189W	D	47.879 1.8850	82.956 3.2660	23.020 0.9063	0.8 0.03	64000 14300	0.50 1.10	
T193	T193W	D	49.454 1.9470	93.269 3.6720	26.187 1.0310	0.8 0.03	86000 19400	0.80 1.76	
T194	T194W	C	49.454 1.9470	93.269 3.6720	26.975 1.0620	0.8 0.03	86000 19400	0.81 1.79	
T201	T201W	D	51.054 2.0100	93.269 3.6720	26.187 1.0310	3.3 0.13	86000 19400	0.77 1.70	
T202	T202W	C	51.054 2.0100	93.269 3.6720	26.975 1.0620	3.3 0.13	86000 19400	0.80 1.76	
T208	T208W	C	52.629 2.0720	93.269 3.6720	26.975 1.0620	0.8 0.03	86000 19400	0.79 1.74	

⁽¹⁾SPCL = special, not shown.

^(*)Contact your Timken engineer for details.

Continued on the next page.

TAPERED ROLLER BEARINGS

THRUST • TYPE TTC, TTCS, TTCL

TYPE TTC, TTCS, TTCL – continued

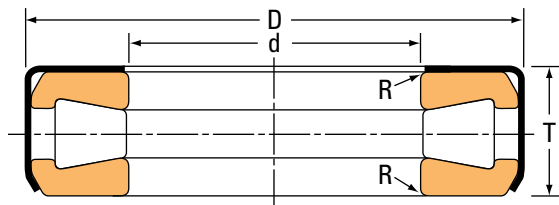


Fig. C. Type TTC.

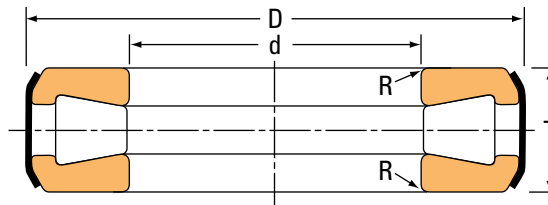


Fig. D. Type TTCS.

Part Number		Fig.	Dimensions				Steering Pivot Rating	Bearing Weight	Remarks
No Oil Holes In Retainer	Oil Holes In Retainer		Bore	Outside Diameter	Width	Shaft Fillet Radius			
			d	D	T	R			
			mm in.	mm in.	mm in.	mm in.	N lbf	kg lbs.	
T209	T209W	D	52.629 2.0720	93.269 3.6720	26.187 1.0310	0.8 0.03	86000 19400	0.75 1.65	
T251	T251W	C	63.754 2.5100	111.125 4.3750	26.988 1.0625	0.8 0.03	124000 27900	1.07 2.36	
T252	T252W	D	63.754 2.5100	111.125 4.3750	25.796 1.0156	0.8 0.03	124000 27900	1.07 2.23	
T301	T301W	D	76.454 3.0100	133.350 5.2500	33.338 1.3125	2.3 0.09	178500 40000	1.87 4.12	
T302	T302W	C	76.454 3.0100	133.350 5.2500	34.925 1.3750	2.3 0.09	178500 40000	1.99 4.39	
T350		D	88.900 3.5000	133.350 5.2500	33.335 1.3124	2.8 0.11	115500 26000	1.41 3.11	
T402	T402W	D	102.108 4.0200	179.619 7.0716	44.450 1.7500	1.5 0.06	344000 77500	4.84 10.67	
T600	T600W	C	152.400 8.0000	241.300 9.5000	76.200 3.0000	3.3 0.13	575000 129000	14.10 31.09	
T1260	T1260W	C	32.004 1.2600	55.562 2.1875	15.875 0.6250	0.8 0.03	27600 6200	0.17 0.37	
T1380		SPCL ⁽¹⁾	35.179 1.3850	59.400 2.3386	15.875 0.6250	0.8 0.03	31200 7000	0.35 0.77	Two-piece seal.
T1921		C	46.279 1.8220	80.010 3.1500	15.977 0.6290	0.8 0.03	56500 12700	0.34 0.75	
T4020		D	102.108 4.0200	179.619 7.0716	31.750 1.2500	1.5 0.06	324000 73000	3.70 8.16	

⁽¹⁾SPCL = special, not shown.

^(*)Contact your Timken engineer for details.

AUXILIARY PARTS

Timken offers a wide range of auxiliary parts for use in the mounting of bearing products. Locknuts, lockwashers and shims may be used to help ensure the proper backing and setting of bearings in the application.



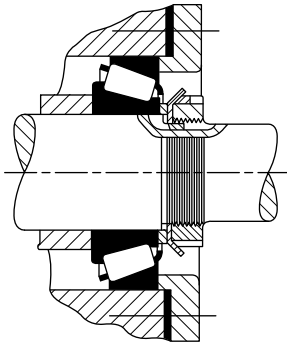
AUXILIARY PARTS**STANDARD LOCKNUTS, LOCKWASHERS AND TONGUED WASHER ASSEMBLIES**

Fig. 43

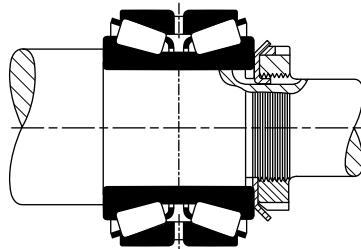


Fig. 44

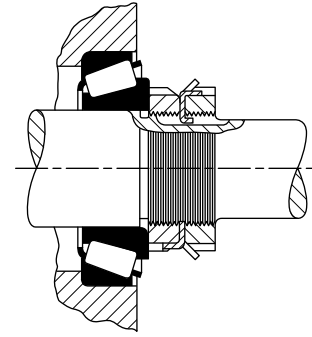


Fig. 45

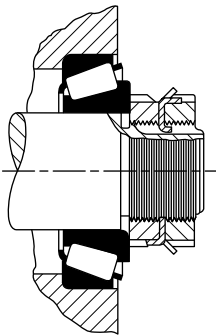


Fig. 46

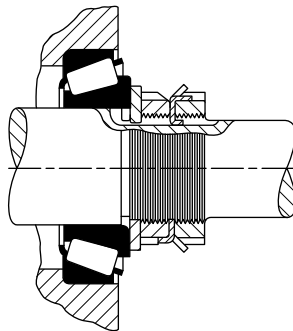


Fig. 47

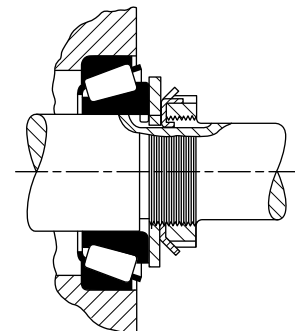


Fig. 48

The designs shown in figs. 43 to 48 show various methods of applying standard locknuts, lockwashers and tongued washers. A single locknut and lockwasher can be used to clamp the inner ring against a sleeve, shown in fig. 43, or directly against a shaft shoulder. A narrow spacer is applied between the front face of the inner ring and the lockwasher so that the lockwasher will clear the bearing cage by a minimum of 3 mm (0.12 in.). The spacer outside diameter should be made a minimum of 6 mm (0.24 in.) smaller than the cage inside diameter, but must still provide the suggested inner ring backing diameter. Fig. 44 shows another clamped design using a single locknut and lockwasher with a double-row bearing of either type TDO with inner ring spacer or type TNA. Since no cage clearance problem is present, the narrow spacer shown in fig. 43 is unnecessary.

Fig. 45, 46, and 47 indicate an adjustable bearing arrangement using two locknuts and a lockwasher. These may be used with either single- or double-row bearings of the types permitting an inner ring adjusted arrangement. The design in fig. 45 allows the maximum shaft extension diameter that can be used with a

shaft thread outside diameter, which will be less than the inner ring bore. Fig. 46 shows an alternate design with smaller thread diameter and corresponding smaller locknuts and lockwasher. The locknut outside diameter, minus two times r , must not be less than the suggested inner ring backing diameter. Fig. 47 indicates the use of a tongued washer located between the inner locknut and inner ring. This is intended for applications where the inner rings are applied with loose fits on hardened stationary shafts as found in many automotive applications. The hardened tongued washers are not sold by The Timken Company.

When space does not permit the use of two locknuts and a lockwasher in an adjustable arrangement, and a single locknut and a lockwasher are used, then a tongued washer must be placed between the inner ring and lockwasher as illustrated in fig. 48. This is necessary to provide adequate backing for the inner ring, in most cases, and to prevent damage to the lockwasher if the inner ring should creep on the shaft. The tongued washers are available from The Timken Company.

STANDARD LOCKNUTS, LOCKWASHERS AND TONGUED WASHERS – METRIC

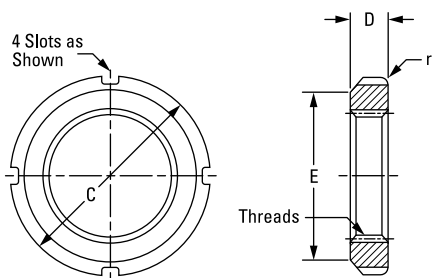


Fig. 49. Locknuts (threads are ISO 965/1, class 5H).

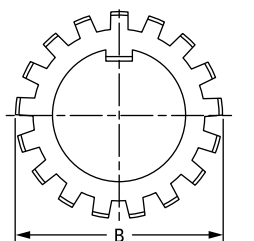


Fig. 50. Lockwashers.

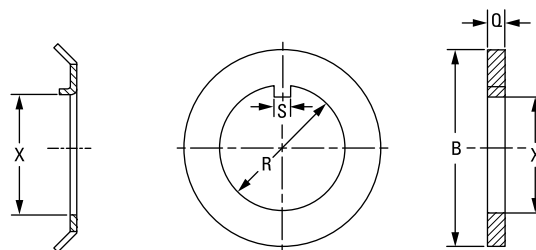


Fig. 51. Tongued washers.

ABMA Locknut Number	Locknut Dimensions					Lockwasher Dimensions					Tongued Washer Dimensions							
	Threads		Outside Dia. C	Thick-ness D	Free Outside Dia. E	Corner Radius r	ABMA Lockwasher Number	Max. Dia. Over Tangs B	Face Dia. F	Thick-ness Q	No. of Tangs	Tongued Washer Number	Bore		Outside Dia. B	Thick-ness Q	Key	
	Min. Value of Major Dia.	Thread Sizes											Min. R	Max. R			Max. S	Min. X
mm	mm	mm	mm	mm	mm	mm	mm	mm	mm	mm	mm	mm	mm	mm	mm	mm	mm	
KMH2	15.000	M15X1	25.000	8.000	21.000	1.17	MBB2	28.000	21.000	1.41	11	MW2	15.095	15.205	22.000	3.25	4.0	12.195
KMH3	17.000	M17X1	28.000	8.000	24.000	1.17	MBB3	32.000	24.000	1.41	11	MW3	17.095	17.205	24.000	3.25	4.0	14.195
KMH4	20.000	M20X1	32.000	9.000	26.000	1.17	MBB4	36.000	26.000	1.41	11	MW4	20.110	20.240	29.000	3.25	4.0	17.295
KMH4.4	22.000	M22X1	34.000	9.000	28.000	1.17	MBB4.4	38.000	28.000	1.41	11	MW4.4	22.110	22.240	31.000	3.25	4.0	19.710
KMH5	25.000	M25X1.5	38.000	10.000	32.000	1.17	MBB5	42.000	32.000	1.41	13	MW5	25.110	25.240	40.000	3.25	5.0	21.910
KMH5.6	28.000	M28X1.5	42.000	10.000	36.000	1.17	MBB5.6	46.000	36.000	1.41	13	MW5.6	28.110	28.240	40.000	3.25	5.0	24.910
KMH6	30.000	M30X1.5	45.000	10.000	38.000	1.17	MBB6	49.000	38.000	1.41	13	MW6	30.110	30.240	45.000	3.25	5.0	26.910
KMH6.4	32.000	M32X1.5	48.000	11.000	40.000	1.59	MBB6.4	52.000	40.000	1.41	13	MW6.4	32.120	32.280	50.000	3.25	5.0	29.010
KMH7	35.000	M35X1.5	52.000	11.000	44.000	1.59	MBB7	57.000	44.000	1.41	13	MW7	35.120	35.280	52.000	3.25	6.0	31.820
KMH8	40.000	M40X1.5	58.000	11.000	50.000	1.59	MBB8	62.000	50.000	1.78	13	MW8	40.120	40.280	57.000	4.20	6.0	36.520
KMH9	45.000	M45X1.5	65.000	12.000	56.000	1.59	MBB9	69.000	56.000	1.78	13	MW9	45.130	45.290	68.000	4.20	6.0	41.530
KMH10	50.000	M50X1.5	70.000	13.000	61.000	1.59	MBB10	74.000	61.000	1.78	13	MW10	50.130	50.290	76.000	4.20	6.0	46.530
KMH11	55.000	M55X2	75.000	13.000	67.000	1.59	MBB11	81.000	67.000	1.78	17	MW11	55.140	55.330	79.000	4.20	8.0	51.140
KMH12	60.000	M60X2	80.000	14.000	73.000	1.59	MBB12	86.000	73.000	1.78	17	MW12	60.140	60.330	88.000	4.70	8.0	55.940
KMH13	65.000	M65X2	85.000	14.000	79.000	2.38	MBB13	92.000	79.000	1.78	17	MW13	65.140	65.330	90.000	4.70	8.0	60.940
KMH14	70.000	M70X2	92.000	14.000	85.000	2.38	MBB14	98.000	85.000	1.78	17	MW14	70.150	70.340	103.000	4.70	8.0	65.950
KMH15	75.000	M75X2	98.000	15.000	90.000	2.38	MBB15	104.000	90.000	2.24	17	MW15	75.150	75.340	103.000	5.70	8.0	70.550
KM16	80.000	M80X2	105.000	15.000	95.000	2.38	MBB16	112.000	95.000	2.24	17	MW16	80.150	80.340	111.000	5.70	10.0	75.150
KM17	85.000	M85X2	110.000	16.000	102.000	2.38	MBB17	119.000	102.000	2.24	17	MW17	85.170	85.390	116.000	5.70	10.0	80.150
KM18	90.000	M90X2	120.000	16.000	108.000	2.38	MBB18	126.000	108.000	2.73	17	MW18	90.170	90.390	121.000	7.62	10.0	84.670
KM19	95.000	M95X2	125.000	17.000	113.000	3.18	MBB19	133.000	113.000	2.73	17	MW19	95.170	95.390	126.000	7.62	10.0	89.670
KM20	100.000	M100X2	130.000	18.000	120.000	3.18	MBB20	142.000	120.000	2.73	17	MW20	100.170	100.390	131.000	7.62	12.0	94.670
KM21	105.000	M105X2	140.000	18.000	126.000	3.18	MBB21	145.000	126.000	2.73	17	MW21	105.180	105.400	125.000	7.62	12.0	99.670
KM22	110.000	M110X2	145.000	19.000	133.000	3.18	MBB22	154.000	133.000	3.25	17	MW22	110.180	110.400	136.000	7.62	12.0	104.180
KM23	115.000	M115X2	150.000	19.000	137.000	3.18	MBB23	159.000	137.000	3.25	17	MW23	115.180	115.400	144.000	7.62	12.0	109.180
KM24	120.000	M120X2	155.000	20.000	138.000	3.18	MBB24	164.000	138.000	3.72	17	MW24	120.180	120.400	150.000	9.57	14.0	113.180
KM25	125.000	M125X2	160.000	21.000	148.000	3.18	MBB25	170.000	148.000	3.72	17	MW25	125.200	125.450	138.000	9.57	14.0	118.180
KM26	130.000	M130X2	165.000	21.000	149.000	3.18	MBB26	175.000	149.000	3.72	17	MW26	130.200	130.450	166.000	9.57	14.0	123.200

STANDARD LOCKNUTS, LOCKWASHERS AND TONGUED WASHERS – INCH

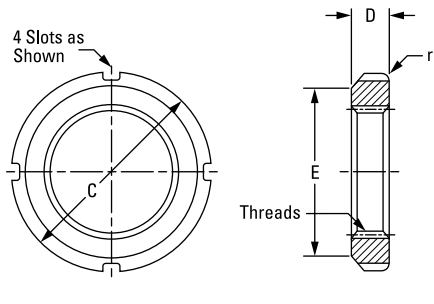


Fig. 52. Locknuts (threads are ISO 965/1, class 5H).

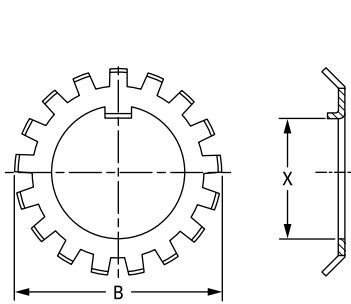


Fig. 53. Lockwashers.

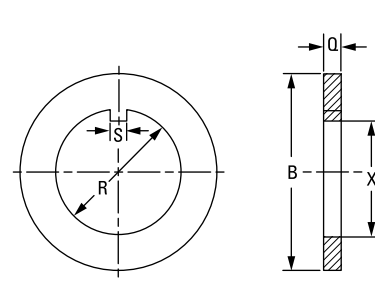


Fig. 54. Tongued washers.

Threads are American National, Form NS, Class 3, with thread length based on 45° chamfer.

ABMA Locknut Number	Locknut Dimensions						Lockwasher Dimensions					Tongued Washer Dimensions						
	Threads		Outside Dia. C	Thick-ness D	Free Outside Dia. E	Corner Radius r	ABMA Lockwasher Number	Max. Dia. Over Tangs B	Face Dia. F	Thick-ness Q	No. of Tangs	Tongued Washer Number	Bore		Outside Dia. B	Thick-ness Q	Key	
	Min. Value of Major Dia.	Thread Sizes											Min. R	Max. R			Max. S	Min. X
in.	in.	in.	in.	in.	in.	in.	in.	in.	in.	in.	in.	in.	in.	in.	in.	in.	in.	
N-00	0.391	32	0.755	0.229	0.625	0.047	TW100	0.891	0.625	0.032	9	K91500	0.406	0.421	0.798	0.109	0.120	0.334
N-01	0.469	32	0.880	0.323	0.719	0.047	TW101	1.031	0.719	0.032	9	K91501	0.484	0.499	0.923	0.109	0.120	0.412
N-02	0.586	32	1.005	0.323	0.813	0.047	TW102	1.156	0.813	0.048	11	K91502	0.601	0.616	1.173	0.125	0.120	0.513
N-03	0.664	32	1.130	0.354	0.938	0.047	TW103	1.344	0.938	0.048	11	K91503	0.679	0.694	1.173	0.125	0.120	0.591
N-04	0.781	32	1.380	0.385	1.125	0.047	TW104	1.563	1.125	0.052	11	K91504	0.801	0.816	1.423	0.125	0.176	0.713
N-05	0.969	32	1.568	0.416	1.281	0.047	TW105	1.703	1.281	0.052	13	K91505	0.989	1.009	1.860	0.125	0.176	0.897
N-06	1.173	18	1.755	0.416	1.500	0.047	TW106	1.953	1.500	0.052	13	K91506	1.193	1.213	1.860	0.125	0.176	1.081
TN-065	1.312	18	2.068	0.448	1.813	0.063	TW065	2.234	1.813	0.052	15	K915065	1.333	1.353	2.173	0.125	0.176	1.221
TN-07	1.376	18	2.068	0.448	1.813	0.063	TW107	2.250	1.813	0.052	15	K91507	1.396	1.416	2.173	0.125	0.176	1.284
TN-08	1.563	18	2.255	0.448	2.000	0.063	TW108	2.484	2.000	0.062	15	K91508	1.583	1.603	2.735	0.156	0.290	1.461
TN-09	1.767	18	2.536	0.448	2.281	0.063	TW109	2.719	2.281	0.062	17	K91509	1.792	1.817	2.735	0.156	0.290	1.670
TN-10	1.967	18	2.693	0.510	2.438	0.063	TW110	2.922	2.438	0.062	17	K91510	1.992	2.017	3.235	0.156	0.290	1.870
TN-11	2.157	18	2.974	0.510	2.656	0.063	TW111	3.094	2.656	0.062	17	K91511	2.182	2.207	3.235	0.156	0.290	2.060
TN-12	2.360	18	3.161	0.541	2.844	0.063	TW112	3.328	2.844	0.072	17	K91512	2.400	2.425	3.735	0.187	0.290	2.248
TN-13	2.548	18	3.380	0.573	3.063	0.094	TW113	3.563	3.063	0.072	19	K91513	2.588	2.613	3.735	0.187	0.290	2.436
TN-14	2.751	18	3.360	0.573	3.313	0.094	TW114	3.813	3.313	0.072	19	K91514	2.791	2.816	3.735	0.187	0.290	2.639
TAN-15	2.933	12	3.880	0.604	3.563	0.094	TW115	4.047	3.563	0.085	19	K91515	2.973	3.003	4.173	0.218	0.290	2.808
TAN-16	3.137	12	4.161	0.604	3.844	0.094	TW116	4.391	3.844	0.085	19	K91516	3.177	3.207	4.173	0.218	0.353	3.012
TAN-17	3.340	12	4.411	0.635	4.031	0.094	TW117	4.625	4.031	0.085	19	K91517	3.395	3.425	4.610	0.218	0.353	3.230
TAN-18	3.527	12	4.661	0.698	4.281	0.094	TW118	4.953	4.281	0.115	19	K91518	3.582	3.612	5.110	0.250	0.353	3.387
TAN-19	3.730	12	4.943	0.729	4.563	0.125	TW119	5.234	4.563	0.115	19	K91519	3.800	3.830	5.110	0.250	0.353	3.605
TAN-20	3.918	12	5.193	0.760	4.813	0.125	TW120	5.484	4.813	0.115	19	K91520	3.988	4.018	5.610	0.250	0.353	3.778
TAN-21	4.122	12	5.443	0.760	5.000	0.125	TW121	5.703	5.000	0.115	19	K91521	4.192	4.222	5.610	0.250	0.353	3.982
TAN-22	4.325	12	5.724	0.791	5.281	0.125	TW122	6.000	5.281	0.130	19	K91522	4.395	4.425	6.110	0.281	0.353	4.170
TAN-24	4.716	12	6.130	0.823	5.688	0.125	TW124	6.531	5.688	0.155	19	K91524	4.801	4.831	6.735	0.375	0.353	4.551
TAN-26	5.106	12	6.755	0.885	6.188	0.125	TW126	7.047	6.188	0.155	19	K91526	5.191	5.226	7.485	0.375	0.435	4.921
TAN-128	5.497	12	7.099	1.198	6.531	0.125	TW128	7.438	6.531	0.155	19	K91528	5.582	5.617	7.485	0.375	0.590	5.312
TAN-130	5.888	12	7.693	1.260	7.063	0.125	TW130	8.063	7.063	0.193	19	K91530	5.983	6.018	7.985	0.375	0.590	5.675
TAN-132	6.284	8	8.068	1.291	7.438	0.156	TW132	8.453	7.438	0.193	19	K91532	6.389	6.424	8.485	0.375	0.590	6.081
TAN-134	6.659	8	8.661	1.354	8.031	0.156	TW134	9.078	8.031	0.193	19	K91534	6.764	6.799	8.985	0.375	0.715	6.456
TAN-136	7.066	8	9.068	1.416	8.375	0.156	TW136	9.438	8.375	0.193	19	K91536	7.171	7.206	9.235	0.375	0.715	6.863
TAN-138	7.472	8	9.474	1.416	8.781	0.156	TW138	9.859	8.781	0.193	19	K91538	7.577	7.612	9.735	0.375	0.715	7.269
TAN-140	7.847	8	9.849	1.510	9.156	0.156	TW140	10.406	9.156	0.193	19	K91540	7.982	8.017	10.110	0.375	0.840	7.674

SHAFT THREAD AND KEYWAY DIMENSIONS FOR STANDARD LOCKNUTS, LOCKWASHERS AND TONGUED WASHERS

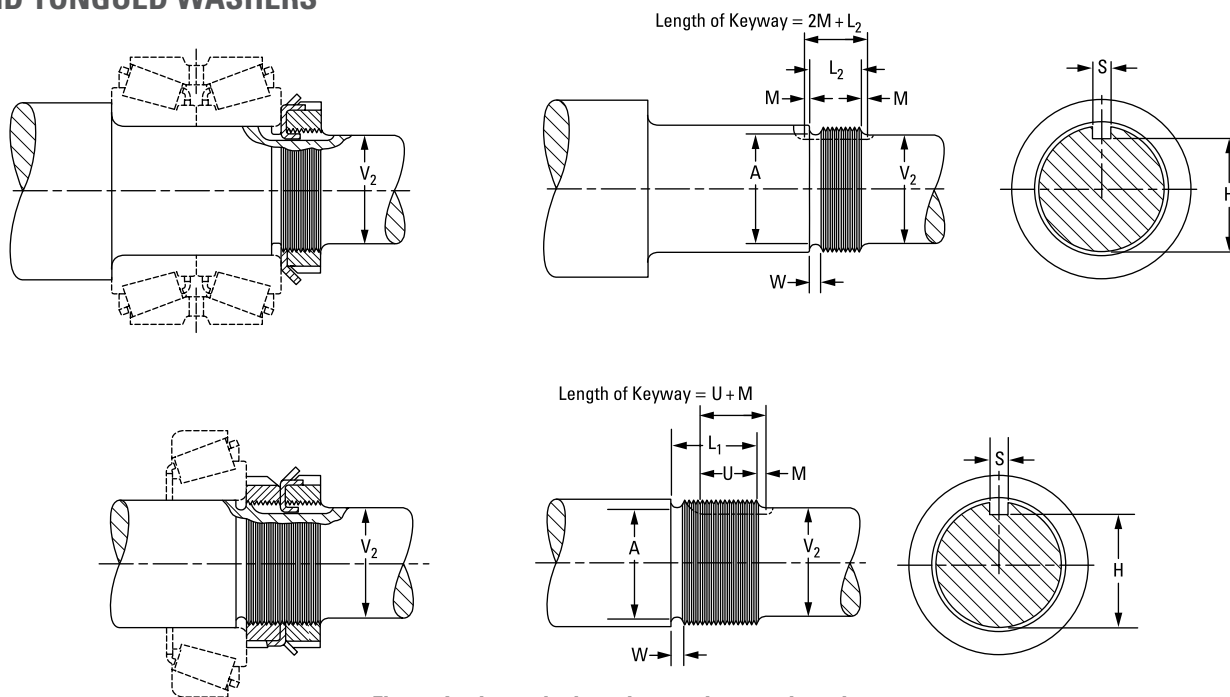


Fig. 55. Locknuts, lockwashers and tongued washers.

These dimensions are ABMA standards.

ABMA Locknut Number	Number Per Inch	Threads									Shaft Ext. Dia. V ₂ Max.	Thread Length		Keyway			
		Major Diameter			Pitch Diameter ⁽¹⁾			Minor Diameter	Relief Diameter	Relief Width +0.016/0.000		+0.016	+0.016	Depth Max.	Width		
		Max.	Tol.	Min.	Max.	Tol.	Min.	Max.	A	W		-0.000	-0.000	H	S ⁽²⁾	M ⁽²⁾	U ⁽²⁾
in.	in.	in.	in.	in.	in.	in.	in.	in.	in.	in.	in.	in.	in.	in.	in.	in.	
N-00	32	0.391	0.0054	0.3856	0.3707	0.0026	0.3681	0.3257	0.3371 ± 0.005	0.062	0.312	0.593	0.375	0.287	0.125	0.094	0.469
N-01	32	0.469	0.0054	0.4636	0.4487	0.0026	0.4461	0.4307	0.4151 ± 0.005	0.062	0.406	0.781	0.468	0.366	0.125	0.094	0.562
N-02	32	0.586	0.0054	0.5806	0.5657	0.0030	0.5627	0.5477	0.5321 ± 0.005	0.062	0.500	0.812	0.500	0.485	0.125	0.094	0.594
N-03	32	0.664	0.0054	0.6586	0.6437	0.0030	0.6407	0.6257	0.6101 ± 0.005	0.062	0.562	0.875	0.531	0.564	0.125	0.094	0.625
N-04	32	0.781	0.0054	0.7756	0.7607	0.0034	0.7573	0.7427	0.7271 ± 0.005	0.062	0.703	0.906	0.531	0.676	0.188	0.094	0.625
N-05	32	0.969	0.0054	0.9636	0.9487	0.0034	0.9453	0.9307	0.9151 ± 0.005	0.062	0.875	1.000	0.593	0.835	0.188	0.125	0.719
N-06	18	1.173	0.0082	1.1648	1.1369	0.0040	1.1329	1.1048	1.0892 ± 0.005	0.093	1.062	1.000	0.593	1.040	0.188	0.125	0.719
TN-065	18	1.312	0.0082	1.3043	1.2764	0.0040	1.2724	1.2443	1.2287 ± 0.005	0.093	1.188	1.062	0.625	1.180	0.188	0.125	0.750
TN-07	18	1.376	0.0082	1.3678	1.3399	0.0040	1.3359	1.3078	1.2922 ± 0.005	0.093	1.250	1.062	0.625	1.244	0.188	0.125	0.750
TN-08	18	1.563	0.0082	1.5548	1.5269	0.0045	1.5224	1.4948	1.4792 ± 0.005	0.093	1.438	1.062	0.625	1.422	0.312	0.125	0.750
TN-09	18	1.767	0.0082	1.7588	1.7309	0.0045	1.7264	1.6988	1.6832 ± 0.005	0.125	1.656	1.062	0.625	1.628	0.312	0.156	0.781
TN-10	18	1.967	0.0082	1.9588	1.9309	0.0045	1.9264	1.8988	1.8832 ± 0.005	0.125	1.859	1.187	0.687	1.830	0.312	0.156	0.844
TN-11	18	2.157	0.0082	2.1488	2.1209	0.0051	2.1158	2.0888	2.0732 ± 0.005	0.125	2.047	1.187	0.687	2.021	0.312	0.156	0.844
TN-12	18	2.360	0.0082	2.3518	2.3239	0.0051	2.3188	2.2918	2.2762 ± 0.005	0.125	2.250	1.281	0.750	2.194	0.312	0.156	0.906
TN-13	18	2.548	0.0082	2.5398	2.5119	0.0051	2.5068	2.4798	2.4642 ± 0.005	0.125	2.422	1.343	0.781	2.382	0.312	0.156	0.938
TN-14	18	2.751	0.0082	2.7428	2.7149	0.0051	2.7098	2.6828	2.6672 ± 0.005	0.125	2.625	1.343	0.781	2.586	0.312	0.250	1.000
TAN-15	12	2.933	0.0112	2.9218	2.8789	0.0054	2.8735	2.8308	2.7995 ± 0.010	0.156	2.781	1.406	0.812	2.737	0.312	0.250	1.031

⁽¹⁾This standard is applicable to steel nuts. When either the nut or the shaft is made of stainless steel, aluminum, or other material having a tendency to seize, it is recommended that the maximum thread diameter of the shaft, both major and pitch, be reduced by 20 percent of the listed pitch diameter tolerance.

⁽²⁾Suggested tolerance on these dimensions of +0.016/-0.000 in.

Continued on next page.

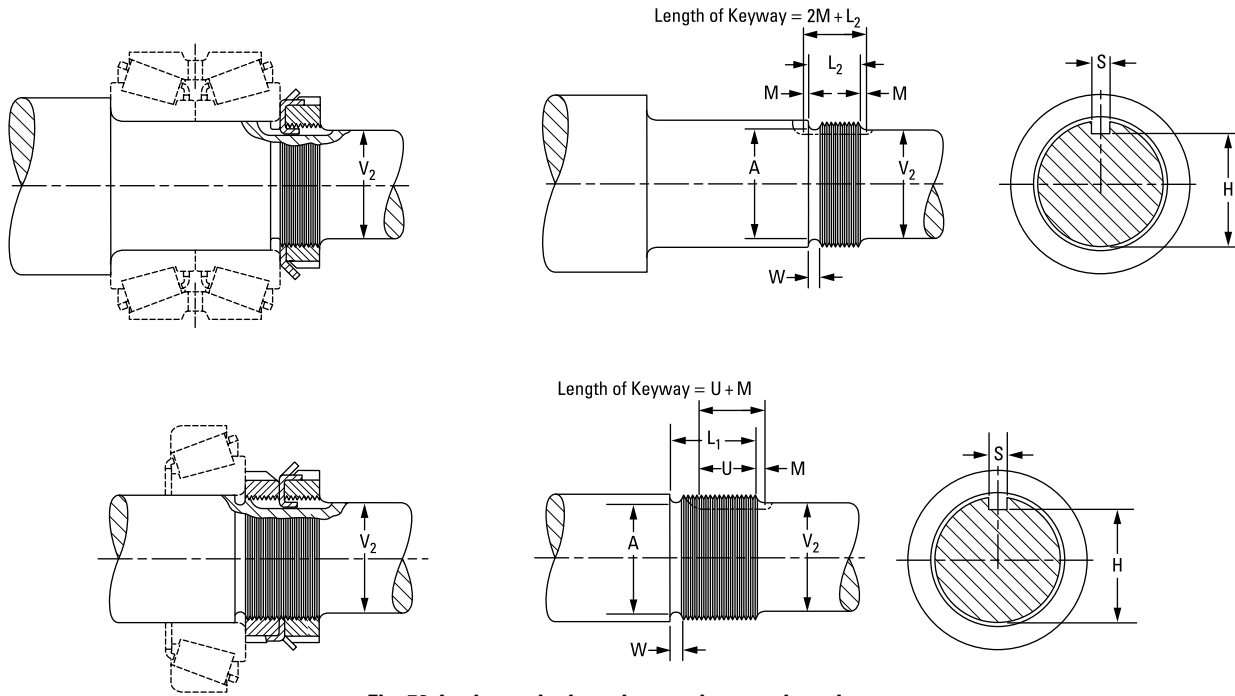


Fig. 56. Locknuts, lockwashers and tongued washers.

These dimensions are ABMA standards.

ABMA Locknut Number	Number Per Inch	Threads									Shaft Ext. Dia. V ₂ Max.	Thread Length		Keyway			
		Major Diameter			Pitch Diameter ⁽¹⁾			Minor Diameter	Relief Diameter	Relief Width +0.016 0.000		+0.016 -0.000	+0.016 -0.000	Depth Max.	Width		
		Max.	Tol.	Min.	Max.	Tol.	Min.	Max.	A	W		L ₁	L ₂	H	S ⁽²⁾	M ⁽²⁾	U ⁽²⁾
in.	in.	in.	in.	in.	in.	in.	in.	in.	in.	in.	in.	in.	in.	in.	in.	in.	
TAN-16	12	3.137	0.0112	3.1258	3.0829	0.0059	3.0770	3.0348	3.0035 ± 0.010	0.156	3.000	1.406	0.812	2.938	0.375	0.250	1.031
TAN-17	12	3.340	0.0112	3.3288	3.2859	0.0059	3.2800	3.2378	3.2065 ± 0.010	0.156	3.188	1.468	0.843	3.141	0.375	0.250	1.062
TAN-18	12	3.527	0.0112	3.5158	3.4729	0.0074	3.4655	3.4248	3.3935 ± 0.010	0.156	3.375	1.625	0.937	3.298	0.375	0.250	1.156
TAN-19	12	3.730	0.0112	3.7188	3.6759	0.0074	3.6685	3.6278	3.5965 ± 0.010	0.156	3.562	1.687	0.968	3.502	0.375	0.250	1.188
TAN-20	12	3.918	0.0112	3.9068	3.8639	0.0074	3.8565	3.8158	3.7845 ± 0.010	0.156	3.766	1.750	1.000	3.690	0.375	0.312	1.281
TAN-21	12	4.122	0.0112	4.1108	4.0679	0.0083	4.0596	4.0198	3.9885 ± 0.010	0.156	3.938	1.750	1.000	3.894	0.375	0.312	1.281
TAN-22	12	4.325	0.0112	4.3138	4.2709	0.0083	4.2626	4.2228	4.1915 ± 0.010	0.156	4.156	1.812	1.031	4.098	0.375	0.312	1.312
TAN-24	12	4.716	0.0112	4.7048	4.6619	0.0083	4.6536	4.6138	4.5825 ± 0.010	0.156	4.531	1.906	1.093	4.458	0.375	0.312	1.375
TAN-26	12	5.106	0.0112	5.0948	5.0519	0.0083	5.0436	5.0038	4.9725 ± 0.010	0.156	4.906	2.031	1.156	4.844	0.500	0.312	1.438
TAN-128	12	5.497	0.0112	5.4858	5.4429	0.0083	5.4346	5.3948	5.3635 ± 0.010	0.156	5.297	2.656	1.468	5.229	0.625	0.312	1.750
TAN-130	12	5.888	0.01125	5.8768	5.8339	0.0083	5.8256	5.7858	5.7545 ± 0.010	0.156	5.656	2.812	1.562	5.590	0.625	0.375	1.906
TAN-132	8	6.284	0.0152	6.2688	6.2028	0.0091	6.1937	6.1306	6.0993 ± 0.010	0.250	6.062	2.875	1.593	5.956	0.625	0.375	1.938
TAN-134	8	6.659	0.0152	6.6438	6.5778	0.0091	6.5687	6.5056	6.4743 ± 0.010	0.250	6.438	3.000	1.656	6.326	0.750	0.375	2.000
TAN-136	8	7.066	0.0152	7.0508	6.9848	0.0091	6.9757	6.9126	6.8813 ± 0.010	0.250	6.844	3.125	1.718	6.734	0.750	0.375	2.062
TAN-138	8	7.472	0.0152	7.4568	7.3908	0.0091	7.3817	7.3186	7.2873 ± 0.010	0.250	7.250	3.125	1.718	7.141	0.750	0.375	2.062
TAN-140	8	7.847	0.0152	7.8318	7.7658	0.0114	7.7544	7.6936	7.6623 ± 0.010	0.250	7.625	3.312	1.812	7.510	0.875	0.375	2.125

⁽¹⁾This standard is applicable to steel nuts. When either the nut or the shaft is made of stainless steel, aluminum, or other material having a tendency to seize, it is recommended that the maximum thread diameter of the shaft, both major and pitch, be reduced by 20 percent of the listed pitch diameter tolerance.

⁽²⁾Suggested tolerance on these dimensions of +0.016/-0.000 in.

CUP SHIMS

STANDARD METAL SHIMS FOR CUP ADJUSTMENT OF BEARINGS

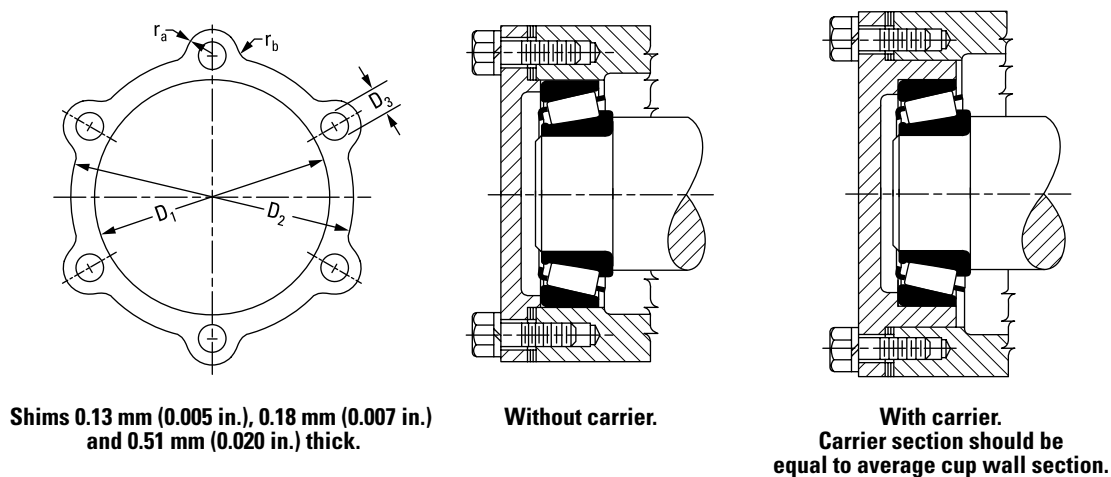


Fig. 57. Cup shims.

Suggested shim sets consist of three 0.13 mm (0.005 in.), three 0.18 mm (0.007 in.) and one 0.51 mm (0.020 in.) thick shims. When ordering, specify the exact quantity for each part number. Shims shown in this table are made from aluminum.

Cup Shims – part number identifies the following:

EXAMPLE

Shim	Size	Thickness (in.)
K2 K2	00	00
K2 06 05	covers number 6 shim	0.13 mm (0.005 in.) thick
K2 06 07	covers number 6 shim	0.18 mm (0.007 in.) thick
K2 06 20	covers number 6 shim	0.51 mm (0.020 in.) thick

AUXILIARY PARTS

CUP SHIMS

Shim Part Numbers			Cap Screws		D ₁	D ₂	D ₃	r _a	r _b
0.13 0.005 Thick	0.18 0.007 Thick	0.51 0.020 Thick	No.	Size					
			mm in.	mm in.	mm in.	mm in.	mm in.	mm in.	
K20605	K20607	K20620	4	6.4 0.25	35.8 1.41	47.8 1.88	7.1 0.28	6.4 0.25	3.0 0.12
K20705	K20707	K20720	4	6.4 0.25	45.2 1.78	57.2 2.25	7.1 0.28	6.4 0.25	3.0 0.12
K20805	K20807	K20820	4	9.7 0.38	51.6 2.03	69.8 2.75	10.4 0.41	9.7 0.38	4.8 0.19
K20905	K20907	K20920	4	9.7 0.38	59.4 2.34	76.2 3.00	10.4 0.41	9.7 0.38	4.8 0.19
K21005	K21007	K21020	4	9.7 0.38	65.8 2.59	82.6 3.25	10.4 0.41	9.7 0.38	4.8 0.19
K21105	K21107	K21120	4	9.7 0.38	70.6 2.78	88.9 3.50	10.4 0.41	9.7 0.38	4.8 0.19
K21205	K21207	K21220	4	9.7 0.38	77.0 3.03	95.2 3.75	10.4 0.41	9.7 0.38	4.8 0.19
K21405	K21407	K21420	4	9.7 0.38	89.7 3.53	108.0 4.25	10.4 0.41	9.7 0.38	4.8 0.19
K21505	K21507	K21520	4	9.7 0.38	96.0 3.78	114.3 4.50	10.4 0.41	9.7 0.38	4.8 0.19
K21605	K21607	K21620	4	12.7 0.50	102.4 4.03	127.0 5.00	13.5 0.53	12.7 0.50	6.4 0.25
K21705	K21707	K21720	4	12.7 0.50	108.7 4.28	133.4 5.25	13.5 0.53	12.7 0.50	6.4 0.25
K21805	K21807	K21820	4	12.7 0.50	115.1 4.53	139.7 5.50	13.5 0.53	12.7 0.50	6.4 0.25
K21905	K21907	K21920	6	12.7 0.50	121.4 4.78	146.0 5.75	13.5 0.53	12.7 0.50	6.4 0.25
K22005	K22007	K22020	6	12.7 0.50	127.8 5.03	152.4 6.00	13.5 0.53	12.7 0.50	6.4 0.25
K22205	K22207	K22220	6	12.7 0.50	140.5 5.53	165.1 6.50	13.5 0.53	12.7 0.50	6.4 0.25
K22405	K22407	K22420	6	12.5 0.50	153.2 6.03	177.8 7.00	13.5 0.53	12.7 0.50	6.4 0.25
K22505	K22507	K22520	6	15.7 0.62	159.5 6.28	190.5 7.50	16.8 0.66	15.7 0.62	7.9 0.31

Shim Part Numbers			Cap Screws		D ₁	D ₂	D ₃	r _a	r _b
0.13 0.005 Thick	0.18 0.007 Thick	0.51 0.020 Thick	No.	Size					
			mm in.	mm in.	mm in.	mm in.	mm in.	mm in.	
K22605	K22607	K22620	6	15.7 0.62	165.9 6.53	196.8 7.75	16.8 0.66	15.7 0.62	7.9 0.31
K22705	K22707	K22720	6	15.7 0.62	172.2 6.78	203.2 8.00	16.8 0.66	15.7 0.62	7.9 0.31
K22905	K22907	K22920	6	15.7 0.62	184.9 7.28	215.9 8.50	16.8 0.66	15.7 0.62	7.9 0.31
K23005	K23007	K23020	6	15.7 0.62	191.3 7.53	222.2 8.75	16.8 0.66	15.7 0.62	7.9 0.31
K23205	K23207	K23220	6	15.7 0.62	204.0 8.03	235.0 9.25	16.8 0.66	15.7 0.62	7.9 0.31
K23405	K23407	K23420	6	15.7 0.62	216.7 8.53	247.6 9.75	16.8 0.66	15.7 0.62	7.9 0.31
K23605	K23607	K23620	6	15.7 0.62	229.4 9.03	260.4 10.25	16.8 0.66	15.7 0.62	7.9 0.31
K23805	K23807	K23820	6	15.7 0.62	242.1 9.53	273.0 10.75	16.8 0.66	15.7 0.62	7.9 0.31
K24005	K24007	K24020	6	19.0 0.75	254.8 10.03	292.1 11.50	19.8 0.78	19.0 0.75	9.7 0.38
K24105	K24107	K24120	8	19.0 0.75	267.5 10.53	304.8 12.00	19.8 0.78	19.0 0.75	9.7 0.38
K24205	K24207	K24220	8	19.0 0.75	296.2 11.66	333.2 13.12	19.8 0.78	19.0 0.75	9.7 0.38
K24405	K24407	K24420	8	19.0 0.75	318.3 12.53	355.6 14.00	19.8 0.78	19.0 0.75	9.7 0.38
K24605	K24607	K24620	8	22.4 0.88	343.7 13.53	387.4 15.25	23.9 0.94	22.4 0.88	11.2 0.44
K24805	K24807	K24820	8	22.4 0.88	369.1 14.53	412.8 16.25	23.9 0.94	22.4 0.88	11.2 0.44
K25005	K25007	K25020	8	25.4 1.00	394.5 15.53	444.5 17.50	26.9 1.06	25.4 1.00	12.7 0.50
K25205	K25207	K25220	8	25.4 1.00	419.9 16.53	469.9 18.50	26.9 1.06	25.4 1.00	12.7 0.50

THESE PARTS HAVE BEEN DESIGNED AND DEVELOPED FOR USE
WITH TIMKEN BEARINGS ONLY.

CONE SHIMS

STANDARD METAL SHIMS FOR CONE ADJUSTED BEARINGS

Suggested shim sets consist of three 0.13 mm (0.005 in.), three 0.18 mm (0.007 in.) and one 0.51 mm (0.020 in.) thick shims.

When ordering, specify the exact quantity for each part number.

Shims shown in this table are made from aluminum, brass or steel shim stock.

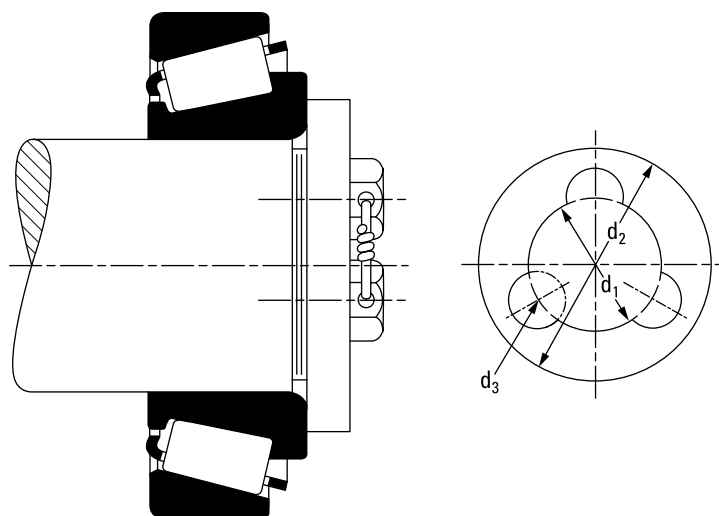


Fig. 58. Cone shims.

Shims		Shaft	Cap Screws		d ₁	d ₂	d ₃
Part Number	Thickness	Size	No.	Size	d ₁	d ₂	d ₃
	mm in.	mm in.		mm in.	mm in.	mm in.	mm in.
T50605	0.13 0.005	63.5 2.50	3	12.7 0.50	35.1 1.38	60.5 2.38	14.2 0.56
T50606	0.18 0.007	to					
T50607	0.51 0.020	73.2 2.88					
T50608	0.13 0.005	76.2 3.00	3	12.7 0.50	44.4 1.75	73.2 2.88	14.2 0.56
T50609	0.18 0.007	to					
T50610	0.51 0.020	85.9 3.38					
T50611	0.13 0.005	88.9 3.50	3	12.7 0.50	57.2 2.25	85.9 3.38	14.2 0.56
T50612	0.18 0.007	to					
T50613	0.51 0.020	104.6 4.12					
T45882	0.13 0.005	108.0 4.25	3	15.7 0.62	76.2 3.00	103.1 4.06	17.5 0.69
T50633	0.18 0.007	to					
T45884	0.51 0.020	117.3 4.62					
T45885	0.13 0.005	120.6 4.75	3	15.7 0.62	88.9 3.50	117.3 4.62	17.5 0.69
T50634	0.18 0.007	to					
T45887	0.51 0.020	124.0 4.88					

Shims		Shaft	Cap Screws		d ₁	d ₂	d ₃
Part Number	Thickness	Size	No.	Size	d ₁	d ₂	d ₃
	mm in.	mm in.		mm in.	mm in.	mm in.	mm in.
T50614	0.13 0.005	127.0 5.00	4	19.0 0.75	88.9 3.50	124.0 4.88	20.6 0.81
T50615	0.18 0.007	to					
T50616	0.51 0.020	136.7 5.38					
T50617	0.13 0.005	139.7 5.50	4	19.0 0.75	88.9 3.50	136.7 5.38	20.6 0.81
T50618	0.18 0.007	to					
T50619	0.51 0.020	149.4 5.88					
T50620	0.13 0.005	152.4 6.00	6	19.0 0.75	101.6 4.00	149.4 5.88	20.6 0.81
T50621	0.18 0.007	to					
T50622	0.51 0.020	174.8 6.88					
T50623	0.13 0.005	177.8 7.00	6	25.4 1.00	127.0 5.00	174.8 6.88	26.9 1.06
T50624	0.18 0.007	to					
T50625	0.51 0.020	200.2 7.88					
T50626	0.13 0.005	203.2 8.00	6	31.8 1.25	152.4 6.00	200.2 7.88	33.3 1.31
T50627	0.18 0.007						
T50628	0.51 0.020						

THESE PARTS HAVE BEEN DESIGNED AND DEVELOPED FOR USE WITH TIMKEN BEARINGS ONLY.

INDEX

Prefix	Base	Suffix	Part Number Prefix + Base + Suffix	Part Type	Type	Page No.
	4	A	4A	Inner	TS	90
	4	C	4C	Inner	TS	90
	6		6	Outer	TS	90
	50		00050	Inner	TS	88
T	63	W	T63W	Thrust	TTSP	731
T	63		T63	Thrust	TTSP	731
T	76	W	T76W	Thrust	TTSP	731
T	76		T76	Thrust	TTSP	731
T	77	W	T77W	Thrust	TTSP	731
T	77		T77	Thrust	TTSP	731
T	82	W	T82W	Thrust	TTSP	731
T	82		T82	Thrust	TTSP	731
T	86		T86	Thrust	TTSP	731
T	88	W	T88W	Thrust	TTSP	731
T	88		T88	Thrust	TTSP	731
T	89		T89	Thrust	TTSP	731
T	92		T92	Thrust	TTSP	731
T	93		T93	Thrust	TTSP	731
T	94	W	T94W	Thrust	TTSP	731
T	94		T94	Thrust	TTSP	731
T	95	W	T95W	Thrust	TTSP	731
T	95		T95	Thrust	TTSP	731
T	101	W	T101W	Thrust	TTSP	731
T	101	X	T101X	Thrust	TTSP	731
T	101		T101	Thrust	TTSP	731
T	102		T102	Thrust	TTSP	732
T	104	W	T104W	Thrust	TTSP	732
T	104		T104	Thrust	TTSP	732
T	105		T105	Thrust	TTSP	732
T	107	W	T107W	Thrust	TTSP	732
T	107		T107	Thrust	TTSP	732
T	110	W	T110W	Thrust	TTSP	732
T	110		T110	Thrust	TTSP	732
T	113	W	T113W	Thrust	TTSP	732
T	113		T113	Thrust	TTSP	732
T	114	W	T114W	Thrust	TTSP	732
T	114	X	T114X	Thrust	TTSP	732
T	114		T114	Thrust	TTSP	732
T	119	W	T119W	Thrust	TTSP	732
T	119		T119	Thrust	TTSP	732
T	120		T120	Thrust	TTSP	732
T	121		T121	Thrust	TTSP	732
T	126	A	T126A	Thrust	TTSP	732
T	126	AW	T126AW	Thrust	TTSP	732
T	126	W	T126W	Thrust	TTSP	732
T	126		T126	Thrust	TTSP	732
T	127	W	T127W	Thrust	TTC	734
T	127		T127	Thrust	TTC	734
T	128		T128	Thrust	TTC	734
T	130		T130	Thrust	TTC	734
T	135		T135	Thrust	TTHD	727
T	136		T136	Thrust	TTC	734
T	138	W	T138W	Thrust	TTC	734
T	138	XS	T138XS	Thrust	TTC	734

Prefix	Base	Suffix	Part Number Prefix + Base + Suffix	Part Type	Type	Page No.
T	138		T138	Thrust	TTC	734
T	139	KP	T139KP	Thrust	TTSP	733
T	139	W	T139W	Thrust	TTSP	733
T	139		T139	Thrust	TTSP	733
T	142	W	T142W	Thrust	TTSP	733
T	142		T142	Thrust	TTSP	733
T	144	W	T144W	Thrust	TTC	735
T	144	XA	T144XA	Thrust	TTC	735
T	144		T144	Thrust	TTC	735
T	149	W	T149W	Thrust	TTSP	733
T	149		T149	Thrust	TTSP	733
	150		00150	Outer	TS	88
T	151	W	T151W	Thrust	TTC	735
T	151		T151	Thrust	TTC	735
T	152		T152	Thrust	TTC	735
T	157	W	T157W	Thrust	TTC	735
T	157		T157	Thrust	TTC	735
T	158		T158	Thrust	TTSP	733
T	163	W	T163W	Thrust	TTC	735
T	163	X	T163X	Thrust	TTC	735
T	163	XW	T163XW	Thrust	TTC	735
T	163		T163	Thrust	TTC	735
T	169	W	T169W	Thrust	TTC	735
T	169		T169	Thrust	TTC	735
T	176	W	T176W	Thrust	TTC	735
T	176		T176	Thrust	TTC	735
T	177	A	T177A	Thrust	TTC	735
T	177	S	T177S	Thrust	TTC	735
T	177	XA	T177XA	Thrust	TTC	735
T	177		T177	Thrust	TTC	735
T	178		T178	Thrust	TTC	735
T	182	W	T182W	Thrust	TTC	735
T	182		T182	Thrust	TTC	735
T	188	W	T188W	Thrust	TTC	735
T	188		T188	Thrust	TTC	735
T	189	W	T189W	Thrust	TTC	735
T	189		T189	Thrust	TTC	735
T	193	W	T193W	Thrust	TTC	735
T	193		T193	Thrust	TTC	735
T	194	W	T194W	Thrust	TTC	735
T	194		T194	Thrust	TTC	735
T	199	W	T199W	Thrust	TTSP	733
T	199		T199	Thrust	TTSP	733
T	200	A	T200A	Thrust	TTHD	727
T	201	W	T201W	Thrust	TTC	735
T	201		T201	Thrust	TTC	735
T	202	W	T202W	Thrust	TTC	735
T	202		T202	Thrust	TTC	735
T	208	W	T208W	Thrust	TTC	735
T	208		T208	Thrust	TTC	735
T	209	W	T209W	Thrust	TTC	736
T	209		T209	Thrust	TTC	736
	242		242	Outer	TS	96
	244	X	244X	Outer	TS	100

TAPERED ROLLER BEARINGS

INDEX

Prefix	Base	Suffix	Part Number Prefix + Base + Suffix	Part Type	Type	Page No.
	246	X	246X	Inner	TS	96
	247		247	Inner	TS	100
T	251	W	T251W	Thrust	TTC	736
T	251		T251	Thrust	TTC	736
T	252	W	T252W	Thrust	TTC	736
T	252		T252	Thrust	TTC	736
T	301	W	T301W	Thrust	TTC	736
T	301		T301	Thrust	TTC	736
T	302	W	T302W	Thrust	TTC	736
T	302		T302	Thrust	TTC	736
T	309	W	T309W	Thrust	TTSP	733
T	309		T309	Thrust	TTSP	733
T	311	F	T311F	Thrust	TTHD	727
T	311		T311	Thrust	TTHD	727
	332	A	332A	Outer	TS	124
	332	A	332A	Outer	TS	136
	332	A	332A	Outer	TS	172
	332	-B	332-B	Outer	TSF	430
	332	-B	332-B	Outer	TSF	432
	332	-B	332-B	Outer	TSF	434
	332	-B	332-B	Outer	TSF	436
	332	-B	332-B	Outer	TSF	438
	332	-B	332-B	Outer	TSF	440
	332	-B	332-B	Outer	TSF	444
	332	-B	332-B	Outer	TSF	446
	332		332	Outer	TS	130
	332		332	Outer	TS	136
	332		332	Outer	TS	140
	332		332	Outer	TS	160
	332		332	Outer	TS	164
	332		332	Outer	TS	172
	334		334	Inner	TSF	430
	335	-S	335-S	Inner	TS	130
	335	-S	335-S	Inner	TSF	434
	335		335	Inner	TS	136
	335		335	Inner	TSF	436
	336		336	Inner	TS	164
	336		336	Inner	TSF	444
	339		339	Inner	TS	140
	339		339	Inner	TSF	438
	342	-S	342-S	Inner	TS	172
	342	-S	342-S	Inner	TSF	446
	342	X	342X	Inner	TSF	446
	342		342	Inner	TS	164
	342		342	Inner	TSF	444
	343		343	Inner	TSF	436
	344	A	344A	Inner	TS	160
	344	A	344A	Inner	TSF	444
	346		346	Inner	TS	124
	346		346	Inner	TSF	432
	347		347	Inner	TS	152
	347		347	Inner	TSF	440
T	350		T350	Thrust	TTC	736
	350	A	350A	Inner	TDO	508
	350	A	350A	Inner	TS	162
	350		350	Inner	TS	160

Prefix	Base	Suffix	Part Number Prefix + Base + Suffix	Part Type	Type	Page No.
	350		350	Inner	TS	162
	352	A	352A	Outer	TS	190
	352	X	352X	Outer	TS	160
	352		352	Outer	TS	162
	352		352	Outer	TS	176
	352		352	Outer	TS	186
	352		352	Outer	TS	190
	353	D	353D	Outer	TDO	508
	353	D	353D	Outer	TDO	510
	353	D	353D	Outer	TDO	512
	353	D	353D	Outer	TNA	638
	354	A	354A	Outer	TS	160
	354	A	354A	Outer	TS	176
	354	A	354A	Outer	TS	184
	354	A	354A	Outer	TS	190
	354	-B	354-B	Outer	TSF	446
	354	-B	354-B	Outer	TSF	448
	354	X	354X	Outer	TS	160
	354	X	354X	Outer	TS	186
	354	X	354X	Outer	TS	190
	355	A	355A	Inner	TDO	508
	355	A	355A	Inner	TS	176
	355	X	355X	Inner	TS	176
	355	X	355X	Inner	TSF	448
	355		355	Inner	TDO	508
	355		355	Inner	TS	176
	355		355	Inner	TSF	446
NA	357		NA357	Inner	TNA	638
	357		357	Inner	TDO	508
	357		357	Inner	TS	160
	357		357	Inner	TS	162
	357		357	Inner	TS	162
	358	A	358A	Inner	TDO	510
	358	A	358A	Inner	TS	184
	358	X	358X	Inner	TS	186
	358		358	Inner	TDO	510
	358		358	Inner	TS	184
	358		358	Inner	TS	186
	358		358	Inner	TSF	448
	359	A	359A	Inner	TS	190
	359	-S	359-S	Inner	TDO	512
	359	-S	359-S	Inner	TS	190
Y1S-	362	A	Y1S-362A	Spacer	2TS-DM	688
	362	A	362A	Outer	2TS-DM	688
	362	A	362A	Outer	TS	166
	362	A	362A	Outer	TS	186
	362	A	362A	Outer	TS	190
	362	A	362A	Outer	TS	192
	362	A	362A	Outer	TS	196
	362	A	362A	Outer	TS	198
	362	A	362A	Outer	TS	202
	362	A	362A	Outer	TS	210
	362	AB	362AB	Outer	TSF	450
	362	AB	362AB	Outer	TSF	454
	362	AX	362AX	Outer	TS	202
	362	-B	362-B	Outer	TSF	448
	362	-B	362-B	Outer	TSF	450

Prefix	Base	Suffix	Part Number Prefix + Base + Suffix	Part Type	Type	Page No.
	362	-B	362-B	Outer	TSF	452
	362	-B	362-B	Outer	TSF	454
	362	X	362X	Outer	TS	184
	362	X	362X	Outer	TS	196
	362	XD	362XD	Outer	TDO	514
	362		362	Outer	TS	168
	362		362	Outer	TS	186
	362		362	Outer	TS	192
	362		362	Outer	TS	198
	362		362	Outer	TS	200
	362		362	Outer	TS	202
	362		362	Outer	TS	210
	363	D	363D	Outer	TDO	508
	363	D	363D	Outer	TDO	510
	363	D	363D	Outer	TDO	512
	363	D	363D	Outer	TDO	514
	363	D	363D	Outer	TDO	516
	363	D	363D	Outer	TNA	640
	363		363	Outer	TS	200
	363		363	Outer	TS	202
	365	A	365A	Inner	TDO	508
	365	A	365A	Inner	TS	166
	365	A	365A	Inner	TS	168
	365	-S	365-S	Inner	TS	196
	365	-S	365-S	Inner	TSF	450
	365		365	Inner	TDO	512
	365		365	Inner	TS	198
	365		365	Inner	TS	200
	365		365	Inner	TSF	452
NA	366		NA366	Inner	TNA	640
	366		366	Inner	TDO	512
	366		366	Inner	TS	198
	366		366	Inner	TS	200
	366		366	Inner	TSF	452
	367	X	367X	Inner	TS	184
	367		367	Inner	TDO	510
	367		367	Inner	TS	186
	367		367	Inner	TSF	448
	368	A	368A	Inner	2TS-DM	688
	368	A	368A	Inner	TDO	514
	368	A	368A	Inner	TS	202
	368	A	368A	Inner	TSF	454
	368	-S	368-S	Inner	TDO	516
	368	-S	368-S	Inner	TS	210
	368		368	Inner	TDO	514
	368		368	Inner	TS	202
	368		368	Inner	TSF	452
	368		368	Inner	TSF	454
	369	A	369A	Inner	TDO	512
	369	A	369A	Inner	TS	190
	369	A	369A	Inner	TS	192
	369	A	369A	Inner	TSF	450
	369	-S	369-S	Inner	TDO	512
	369	-S	369-S	Inner	TS	192
	369	-S	369-S	Inner	TSF	450
	370	A	370A	Inner	TS	202

Prefix	Base	Suffix	Part Number Prefix + Base + Suffix	Part Type	Type	Page No.
	372	A	372A	Outer	TDI	600
	372	A	372A	Outer	TS	186
	372	A	372A	Outer	TS	198
	372	A	372A	Outer	TS	204
	372	A	372A	Outer	TS	212
	372		372	Outer	TS	186
	372		372	Outer	TS	204
	372		372	Outer	TS	212
	374		374	Outer	TDI	600
	374		374	Outer	TS	186
	374		374	Outer	TS	202
	374		374	Outer	TS	212
	375	D	375D	Inner	TDI	600
	375	-S	375-S	Inner	TS	202
	375	-S	375-S	Inner	TS	204
	375		375	Inner	TS	202
	375		375	Inner	TS	204
	376		376	Inner	TS	186
	377	A	377A	Inner	TS	212
	377		377	Inner	TS	212
	378	A	378A	Inner	TS	198
Y1S-	382	A	Y1S-382A	Spacer	2TS-DM	688
Y4S-	382	A	Y4S-382A	Spacer	2TS-IM	664
	382	A	382A	Outer	2TS-DM	688
	382	A	382A	Outer	2TS-IM	664
	382	A	382A	Outer	TDI	600
	382	A	382A	Outer	TS	180
	382	A	382A	Outer	TS	192
	382	A	382A	Outer	TS	204
	382	A	382A	Outer	TS	214
	382	A	382A	Outer	TS	220
	382	A	382A	Outer	TS	222
	382	A	382A	Outer	TS	224
	382	A	382A	Outer	TS	230
	382	-B	382-B	Outer	TSF	456
	382	-B	382-B	Outer	TSF	458
	382	-S	382-S	Outer	TS	204
	382	-S	382-S	Outer	TS	224
	382		382	Outer	TS	204
	382		382	Outer	TS	214
	382		382	Outer	TS	220
	382		382	Outer	TS	224
	382		382	Outer	TS	230
	383	A	383A	Outer	TS	204
	383	A	383A	Outer	TS	214
	383	A	383A	Outer	TS	220
	383	A	383A	Outer	TS	222
	383	A	383A	Outer	TS	224
	383	A	383A	Outer	TS	230
	383	X	383X	Outer	TS	206
	383	X	383X	Outer	TS	224
	384	CD	384CD	Outer	TNA	640
	384	D	384D	Outer	TDO	512
	384	D	384D	Outer	TDO	514
	384	D	384D	Outer	TDO	516
	384	D	384D	Outer	TDO	518

TAPERED ROLLER BEARINGS

INDEX

Prefix	Base	Suffix	Part Number Prefix + Base + Suffix	Part Type	Type	Page No.
	384	D	384D	Outer	TDO	520
	384	ED	384ED	Outer	TDO	512
	384	ED	384ED	Outer	TDO	514
	384	ED	384ED	Outer	TDO	516
	384	ED	384ED	Outer	TDO	518
	384	ED	384ED	Outer	TDO	520
	384	XD	384XD	Outer	TDO	520
NA	385		NA385	Inner	TNA	640
X4S-	385		X4S-385	Spacer	2TS-IM	664
	385	A	385A	Inner	TDO	514
	385	A	385A	Inner	TS	204
	385	A	385A	Inner	TS	206
	385	X	385X	Inner	TDO	518
	385	X	385X	Inner	TS	220
	385		385	Inner	TDO	518
	385		385	Inner	TS	220
	385		385	Inner	TSF	456
	386	A	386A	Inner	TDO	512
	386	A	386A	Inner	TS	192
	386	AS	386AS	Inner	TS	180
T	387	W	T387W	Thrust	TTSP	733
T	387		T387	Thrust	TTSP	733
X1S-	387		X1S-387	Spacer	2TS-IM	664
X3S-	387	A	X3S-387A	Spacer	2TS-IM	664
	387	A	387A	Inner	2TS-DM	688
	387	A	387A	Inner	2TS-IM	664
	387	A	387A	Inner	TDO	518
	387	A	387A	Inner	TDO	520
	387	A	387A	Inner	TS	224
	387	A	387A	Inner	TSF	458
	387	AS	387AS	Inner	TDO	518
	387	AS	387AS	Inner	TDO	520
	387	AS	387AS	Inner	TS	224
	387	-S	387-S	Inner	TDO	518
	387	-S	387-S	Inner	TDO	520
	387	-S	387-S	Inner	TS	224
	387		387	Inner	TDO	518
	387		387	Inner	TS	224
	387		387	Inner	TSF	458
	388	A	388A	Inner	TDO	520
	388	A	388A	Inner	TS	230
	389	A	389A	Inner	TDO	516
	389	A	389A	Inner	TS	214
	389	DE	389DE	Inner	TDI	600
	389		389	Inner	TDO	518
	389		389	Inner	TS	222
	389		389	Inner	TSF	456
	390	A	390A	Inner	TDO	522
	390	A	390A	Inner	TS	240
	390	A	390A	Inner	TS	242
	390	A	390A	Inner	TSL	496
	390		390	Inner	TDO	520
	390		390	Inner	TS	226
	392		392	Inner	2S	714
	392		392	Inner	TDO	522
	392		392	Inner	TS	238

Prefix	Base	Suffix	Part Number Prefix + Base + Suffix	Part Type	Type	Page No.
	393	A	393A	Outer	TS	248
	393	A	393A	Outer	TS	250
	393	AS	393AS	Outer	TS	256
Y7S-	394	A	Y7S-394A	Spacer	2TS-IM	666
	394	A	394A	Outer	2TS-IM	666
	394	A	394A	Outer	2S	714
	394	A	394A	Outer	TS	226
	394	A	394A	Outer	TS	232
	394	A	394A	Outer	TS	238
	394	A	394A	Outer	TS	240
	394	A	394A	Outer	TS	250
	394	A	394A	Outer	TS	256
	394	A	394A	Outer	TSL	496
	394	AB	394AB	Outer	TSF	464
	394	AS	394AS	Outer	TS	226
	394	AS	394AS	Outer	TS	232
	394	AS	394AS	Outer	TS	240
	394	AS	394AS	Outer	TS	250
	394	D	394D	Outer	TDO	514
	394	D	394D	Outer	TDO	516
	394	D	394D	Outer	TDO	520
	394	D	394D	Outer	TDO	522
	394	D	394D	Outer	TDO	524
	394	D	394D	Outer	TDO	526
	394	D	394D	Outer	TNA	640
	394		394	Outer	TS	240
	394		394	Outer	TS	250
	395	A	395A	Inner	TDO	524
	395	A	395A	Inner	TS	250
	395	LA	395LA	Seal	TSL	496
	395	LC	395LC	Seal	TSL	496
	395	-S	395-S	Inner	TDO	524
	395	-S	395-S	Inner	TS	250
	395		395	Inner	TDO	522
	395		395	Inner	TS	240
	395		395	Inner	TS	242
	395		395	Inner	TSF	462
	396		396	Inner	TDO	514
NA	397		NA397	Inner	TNA	640
	397		397	Inner	TDO	522
	397		397	Inner	TS	232
	398		398	Inner	TDO	516
X1S-	399	A	X1S-399A	Spacer	2TS-IM	666
X5S-	399	A	X5S-399A	Spacer	2S	714
X7S-	399	A	X7S-399A	Spacer	2TS-IM	666
	399	A	399A	Inner	2TS-IM	666
	399	A	399A	Inner	2S	714
	399	A	399A	Inner	TDO	524
	399	A	399A	Inner	TS	256
	399	A	399A	Inner	TSF	464
	399	A	399A	Inner	TSL	496
	399	AS	399AS	Inner	TDO	526
	399	AS	399AS	Inner	TS	256
	399		399	Inner	TS	248
T	402	W	T402W	Thrust	TTC	736
T	402		T402	Thrust	TTC	736

Prefix	Base	Suffix	Part Number Prefix + Base + Suffix	Part Type	Type	Page No.
	412	A	412A	Outer	TS	142
Y1H	414		Y1H414	Spacer	2TS-IM	660
	414	A	414A	Outer	TS	154
	414	X	414X	Outer	TS	154
	414	X	414X	Outer	TS	160
	414		414	Outer	2TS-IM	660
	414		414	Outer	TS	138
	414		414	Outer	TS	142
	414		414	Outer	TS	154
	414		414	Outer	TS	160
	414		414	Outer	TS	166
	417		417	Inner	TS	138
	418		418	Inner	TS	154
	419		419	Inner	TS	166
	420		420	Inner	2TS-IM	660
	420		420	Inner	TS	160
	421		421	Inner	TS	142
	430	X	430X	Outer	TS	186
	432	A	432A	Outer	TS	178
	432	AB	432AB	Outer	TSF	434
	432	AB	432AB	Outer	TSF	438
	432	AB	432AB	Outer	TSF	440
	432	AB	432AB	Outer	TSF	442
	432	AB	432AB	Outer	TSF	444
	432	AB	432AB	Outer	TSF	446
	432	AB	432AB	Outer	TSF	448
	432	-B	432-B	Outer	TSF	434
	432	-B	432-B	Outer	TSF	438
	432	-B	432-B	Outer	TSF	440
	432	-B	432-B	Outer	TSF	442
	432	-B	432-B	Outer	TSF	444
	432	-B	432-B	Outer	TSF	446
	432	-B	432-B	Outer	TSF	448
	432	D	432D	Outer	TDO	508
	432	D	432D	Outer	TDO	510
	432	D	432D	Outer	TDO	512
	432	D	432D	Outer	TNA	638
	432	D	432D	Outer	TNASW	650
	432	D	432D	Outer	TNASWE	654
	432	X	432X	Outer	TS	168
	432	X	432X	Outer	TS	190
	432		432	Outer	TS	138
	432		432	Outer	TS	154
	432		432	Outer	TS	162
	432		432	Outer	TS	168
	432		432	Outer	TS	178
	432		432	Outer	TS	190
NA	435	SW	NA435SW	Inner	TNASWE	654
	435	-S	435-S	Inner	TS	186
	435		435	Inner	TDO	510
	435		435	Inner	TS	178
	435		435	Inner	TSF	446
	436		436	Inner	TDO	512
	436		436	Inner	TS	190
	436		436	Inner	TSF	448
NA	438	SW	NA438SW	Inner	TNASW	650

Prefix	Base	Suffix	Part Number Prefix + Base + Suffix	Part Type	Type	Page No.
NA	438		NA438	Inner	TNA	638
	438		438	Inner	TDO	510
	438		438	Inner	TS	178
	438		438	Inner	TSF	446
	440		440	Inner	TS	154
	440		440	Inner	TSF	440
	441		441	Inner	TSF	438
	442	-S	442-S	Inner	TS	162
	442	-S	442-S	Inner	TSF	442
	444		444	Inner	TS	154
	444		444	Inner	TSF	440
	447		447	Inner	TDO	508
	447		447	Inner	TS	168
	447		447	Inner	TSF	444
	449		449	Inner	TS	138
	449		449	Inner	TSF	434
T	451		T451	Thrust	TTHD	727
	452	A	452A	Outer	TS	216
	452	A	452A	Outer	TS	226
	452	D	452D	Outer	TDO	508
	452	D	452D	Outer	TDO	510
	452	D	452D	Outer	TDO	512
	452	D	452D	Outer	TDO	514
	452	D	452D	Outer	TDO	516
	452	D	452D	Outer	TDO	518
	452	D	452D	Outer	TDO	520
	452	D	452D	Outer	TNA	640
	452	D	452D	Outer	TNASW	650
	452	D	452D	Outer	TNASWE	654
	453	A	453A	Outer	TS	156
	453	A	453A	Outer	TS	168
	453	A	453A	Outer	TS	170
	453	A	453A	Outer	TS	182
	453	A	453A	Outer	TS	186
	453	A	453A	Outer	TS	194
	453	A	453A	Outer	TS	208
	453	A	453A	Outer	TS	212
	453	A	453A	Outer	TS	216
	453	A	453A	Outer	TS	222
	453	A	453A	Outer	TS	226
	453	AS	453AS	Outer	TS	214
	453	AS	453AS	Outer	TS	216
	453	AS	453AS	Outer	TS	222
	453	AS	453AS	Outer	TS	226
	453	-B	453-B	Outer	TSF	444
	453	-B	453-B	Outer	TSF	446
	453	-B	453-B	Outer	TSF	450
	453	-B	453-B	Outer	TSF	452
	453	-B	453-B	Outer	TSF	454
	453	-B	453-B	Outer	TSF	456
	453	-B	453-B	Outer	TSF	458
	453	X	453X	Outer	2TS-IM	664
	453	X	453X	Outer	TS	170
	453	X	453X	Outer	TS	182
	453	X	453X	Outer	TS	206
	453	X	453X	Outer	TS	212

TAPERED ROLLER BEARINGS

INDEX

Prefix	Base	Suffix	Part Number Prefix + Base + Suffix	Part Type	Type	Page No.
	453	X	453X	Outer	TS	214
	453	X	453X	Outer	TS	224
	453	X	453X	Outer	TS	226
	453		453	Outer	TS	170
	453		453	Outer	TS	208
	453		453	Outer	TS	216
	454		454	Outer	TS	170
	454		454	Outer	TS	208
	454		454	Outer	TS	216
	454		454	Outer	TS	226
NA	455	SW	NA455SW	Inner	TNASW	650
NA	455		NA455	Inner	TNA	640
	455	A	455A	Inner	TS	156
	455	-S	455-S	Inner	TDO	514
	455	-S	455-S	Inner	TS	206
	455	-S	455-S	Inner	TS	208
	455	-S	455-S	Inner	TSF	452
	455		455	Inner	TDO	514
	455		455	Inner	TS	206
	455		455	Inner	TS	208
	455		455	Inner	TSF	452
NA	456	SW	NA456SW	Inner	TNASWE	654
	456		456	Inner	TDO	516
	456		456	Inner	TS	214
	456		456	Inner	TS	216
	456		456	Inner	TSF	454
	458	-S	458-S	Inner	TS	186
	458		458	Inner	TDO	510
	460		460	Inner	TS	182
	460		460	Inner	TSF	446
	461		461	Inner	TS	170
	461		461	Inner	TSF	444
X5S-	462		X5S-462	Spacer	2TS-IM	664
	462	A	462A	Inner	TS	226
	462		462	Inner	2TS-IM	664
	462		462	Inner	TDO	520
	462		462	Inner	TS	224
	462		462	Inner	TS	226
	462		462	Inner	TSF	458
	463		463	Inner	TSF	450
	464	A	464A	Inner	TS	168
	464		464	Inner	TDO	508
	464		464	Inner	TS	170
	465		465	Inner	TDO	514
	466	-S	466-S	Inner	TDO	518
	466	-S	466-S	Inner	TS	222
	466	-S	466-S	Inner	TSF	456
	466		466	Inner	TDO	518
	467		467	Inner	TDO	512
	467		467	Inner	TS	194
	467		467	Inner	TSF	450
	468		468	Inner	TDO	516
	468		468	Inner	TS	212
	468		468	Inner	TS	214
	469		469	Inner	TDO	520
	469		469	Inner	TS	224

Prefix	Base	Suffix	Part Number Prefix + Base + Suffix	Part Type	Type	Page No.
	469		469	Inner	TS	226
	469		469	Inner	TSF	456
	472	A	472A	Outer	TS	222
	472	A	472A	Outer	TS	242
	472	A	472A	Outer	TS	248
	472	A	472A	Outer	TS	252
	472	A	472A	Outer	TS	256
	472	A	472A	Outer	TS	258
	472	A	472A	Outer	TS	262
	472	-B	472-B	Outer	TSF	456
	472	-B	472-B	Outer	TSF	458
	472	-B	472-B	Outer	TSF	460
	472	-B	472-B	Outer	TSF	462
	472	-B	472-B	Outer	TSF	464
	472	-B	472-B	Outer	TSF	466
	472	D	472D	Outer	TDO	518
	472	D	472D	Outer	TDO	522
	472	D	472D	Outer	TDO	524
	472	D	472D	Outer	TDO	526
	472	D	472D	Outer	TDO	528
	472	D	472D	Outer	TNA	640
	472	D	472D	Outer	TNA	642
	472	D	472D	Outer	TNASW	650
	472	D	472D	Outer	TNASWE	654
	472	X	472X	Outer	TS	244
	472	X	472X	Outer	TS	248
	472	X	472X	Outer	TS	254
	472	X	472X	Outer	TS	260
	472	X	472X	Outer	TS	262
	472		472	Outer	TS	222
	472		472	Outer	TS	234
	472		472	Outer	TS	242
	472		472	Outer	TS	248
	472		472	Outer	TS	252
	472		472	Outer	TS	256
	472		472	Outer	TS	260
	473		473	Outer	TS	222
	473		473	Outer	TS	242
	473		473	Outer	TS	248
	473		473	Outer	TS	256
	473		473	Outer	TS	260
	475		475	Inner	TDO	518
	475		475	Inner	TS	222
	475		475	Inner	TSF	456
NA	476		NA476	Inner	TNA	640
	476		476	Inner	TDO	522
	476		476	Inner	TS	234
	476		476	Inner	TSF	458
	477		477	Inner	TDO	522
	477		477	Inner	TS	242
	477		477	Inner	TSF	460
	478		478	Inner	TDO	524
	478		478	Inner	TS	248
	478		478	Inner	TSF	462
	479		479	Inner	TDO	524
	479		479	Inner	TS	252

Prefix	Base	Suffix	Part Number Prefix + Base + Suffix	Part Type	Type	Page No.
	479		479	Inner	TS	254
	479		479	Inner	TSF	462
	480		480	Inner	TDO	526
	480		480	Inner	TS	256
	480		480	Inner	TSF	464
NA	482		NA482	Inner	TNA	640
	482	A	482A	Inner	TS	258
	482		482	Inner	TDO	526
	482		482	Inner	TS	258
	482		482	Inner	TS	260
	482		482	Inner	TSF	464
NA	483	SW	NA483SW	Inner	TNASWE	654
	483		483	Inner	TDO	524
	483		483	Inner	TS	242
	483		483	Inner	TS	244
	483		483	Inner	TSF	462
NA	484	SW	NA484SW	Inner	TNASW	650
NA	484		NA484	Inner	TNA	642
T	484		T484	Thrust	TTSP	733
	484		484	Inner	TDO	528
	484		484	Inner	TS	262
	484		484	Inner	TSF	466
	492	A	492A	Outer	TDI	600
	492	A	492A	Outer	TS	270
	492	A	492A	Outer	TS	276
	492	A	492A	Outer	TS	280
	492	A	492A	Outer	TS	282
	492	A	492A	Outer	TS	286
	492	A	492A	Outer	TS	288
Y3S-	493		Y3S-493	Spacer	2TS-DM	692
Y4S-	493		Y4S-493	Spacer	2TS-DM	694
	493	-B	493-B	Outer	TSF	468
	493	-B	493-B	Outer	TSF	470
	493	-B	493-B	Outer	TSF	472
	493	D	493D	Outer	TDO	528
	493	D	493D	Outer	TDO	530
	493	D	493D	Outer	TDO	532
	493	D	493D	Outer	TDO	534
	493	D	493D	Outer	TNA	642
	493	D	493D	Outer	TNASW	650
	493		493	Outer	2TS-DM	692
	493		493	Outer	2TS-DM	694
	493		493	Outer	TDI	600
	493		493	Outer	TS	254
	493		493	Outer	TS	266
	493		493	Outer	TS	272
	493		493	Outer	TS	280
	493		493	Outer	TS	282
	493		493	Outer	TS	286
	493		493	Outer	TS	288
NA	495	A	NA495A	Inner	TNA	642
NA	495	SW	NA495SW	Inner	TNASW	650
	495	A	495A	Inner	2TS-DM	692
	495	A	495A	Inner	TDO	530
	495	A	495A	Inner	TS	270
	495	A	495A	Inner	TS	272

Prefix	Base	Suffix	Part Number Prefix + Base + Suffix	Part Type	Type	Page No.
	495	A	495A	Inner	TSF	468
	495	AA	495AA	Inner	TS	254
	495	AS	495AS	Inner	TDO	532
	495	AS	495AS	Inner	TS	276
	495	AX	495AX	Inner	TS	272
	495	-S	495-S	Inner	TDO	528
	495	-S	495-S	Inner	TS	266
	495		495	Inner	TDO	532
	495		495	Inner	TS	282
	495		495	Inner	TSF	470
	496	D	496D	Inner	TDI	600
	496		496	Inner	2TS-DM	694
	496		496	Inner	TDO	532
	496		496	Inner	TS	280
	496		496	Inner	TSF	470
NA	497	SW	NA497SW	Inner	TNASW	650
	497	A	497A	Inner	TS	288
	497		497	Inner	TDO	534
	497		497	Inner	TS	288
	497		497	Inner	TSF	472
	498		498	Inner	TDO	534
	498		498	Inner	TS	286
	498		498	Inner	TSF	470
T	511		T511	Thrust	TTHD	727
J	520		J520	Outer	TS	206
	520	X	520X	Outer	TS	192
	520	X	520X	Outer	TS	206
Y1S-	522		Y1S-522	Spacer	2TS-IM	664
	522		522	Outer	2TS-IM	664
	522		522	Outer	TS	154
	522		522	Outer	TS	168
	522		522	Outer	TS	180
	522		522	Outer	TS	192
	522		522	Outer	TS	194
	522		522	Outer	TS	206
	525	X	525X	Inner	TS	154
	525		525	Inner	TS	154
	526		526	Inner	TS	168
	527		527	Inner	TS	180
	528	A	528A	Inner	TS	192
	528	R	528R	Inner	TS	194
	528		528	Inner	TS	192
X1S-	529		X1S-529	Spacer	2TS-IM	664
	529	X	529X	Inner	TS	206
	529		529	Inner	2TS-IM	664
	529		529	Inner	TS	206
	532	A	532A	Outer	TS	156
	532	A	532A	Outer	TS	182
	532	A	532A	Outer	TS	214
	532	A	532A	Outer	TS	216
	532	-B	532-B	Outer	TSF	438
	532	-B	532-B	Outer	TSF	450
	532	X	532X	Outer	TS	162
	532	X	532X	Outer	TS	170
	532	X	532X	Outer	TS	194
	532	X	532X	Outer	TS	198

TAPERED ROLLER BEARINGS

INDEX

Prefix	Base	Suffix	Part Number Prefix + Base + Suffix	Part Type	Type	Page No.
	532	X	532X	Outer	TS	214
	532	X	532X	Outer	TS	216
	532		532	Outer	TS	194
	533	A	533A	Outer	TS	154
	533	A	533A	Outer	TS	220
	533	D	533D	Outer	TDO	506
	533	D	533D	Outer	TDO	516
	533	D	533D	Outer	TNA	640
	533	X	533X	Outer	TS	220
	534		534	Outer	TS	214
	534		534	Outer	TS	216
	535		535	Inner	TS	182
	536		536	Inner	TS	194
	538		538	Inner	TS	220
NA	539		NA539	Inner	TNA	640
	539	A	539A	Inner	TS	216
	539		539	Inner	TDO	516
	539		539	Inner	TS	216
	540		540	Inner	TS	214
	541		541	Inner	TS	170
	542		542	Inner	TDO	506
	542		542	Inner	TS	154
	542		542	Inner	TS	156
	542		542	Inner	TSF	438
	543		543	Inner	TS	162
	545		545	Inner	TSF	450
	546		546	Inner	TS	198
	546		546	Inner	TSF	450
Y3S-	552	A	Y3S-552A	Spacer	2TS-DM	690
	552	A	552A	Outer	2TS-DM	690
	552	A	552A	Outer	TS	210
	552	A	552A	Outer	TS	218
	552	A	552A	Outer	TS	222
	552	A	552A	Outer	TS	228
	552	A	552A	Outer	TS	234
	552	A	552A	Outer	TS	236
	552	A	552A	Outer	TS	238
	552	A	552A	Outer	TS	244
	552	A	552A	Outer	TS	254
	552	A	552A	Outer	TS	256
	552	-B	552-B	Outer	TSF	454
	552	-B	552-B	Outer	TSF	456
	552	-B	552-B	Outer	TSF	460
	552	-B	552-B	Outer	TSF	462
	552	D	552D	Outer	TDO	516
	552	D	552D	Outer	TDO	518
	552	D	552D	Outer	TDO	520
	552	D	552D	Outer	TDO	522
	552	D	552D	Outer	TDO	524
	552	D	552D	Outer	TDO	526
	552	D	552D	Outer	TNA	640
	552	D	552D	Outer	TNASW	650
	552	-S	552-S	Outer	TS	256
	552		552	Outer	TS	210
	552		552	Outer	TS	228
	552		552	Outer	TS	234

Prefix	Base	Suffix	Part Number Prefix + Base + Suffix	Part Type	Type	Page No.
	552		552	Outer	TS	244
	552		552	Outer	TS	254
	552		552	Outer	TS	256
	553	A	553A	Outer	TS	228
	553	A	553A	Outer	TS	232
	553	-BA	553-BA	Outer	TSF	454
	553	-SA	553-SA	Outer	TS	228
	553	-SA	553-SA	Outer	TS	232
	553	-SA	553-SA	Outer	TS	254
	553	-SB	553-SB	Outer	TSF	458
	554		554	Inner	2TS-DM	690
	554		554	Inner	TDO	522
	554		554	Inner	TS	238
	554		554	Inner	TSF	460
	555	-S	555-S	Inner	TDO	520
	555	-S	555-S	Inner	TS	228
	555	-S	555-S	Inner	TSF	456
	555		555	Inner	TDO	516
	555		555	Inner	TS	210
	557	-S	557-S	Inner	TDO	518
	557	-S	557-S	Inner	TS	218
	557	-S	557-S	Inner	TSF	454
	557		557	Inner	TS	222
NA	558	SW	NA558SW	Inner	TNASW	650
NA	558		NA558	Inner	TNA	640
	558	A	558A	Inner	TDO	522
	558	A	558A	Inner	TS	236
	558	-S	558-S	Inner	TDO	522
	558	-S	558-S	Inner	TS	232
	558	-S	558-S	Inner	TSF	458
	558		558	Inner	TDO	522
	558		558	Inner	TS	234
	558		558	Inner	TSF	460
	559		559	Inner	TDO	524
	559		559	Inner	TS	244
	559		559	Inner	TSF	460
	560	-S	560-S	Inner	TDO	526
	560	-S	560-S	Inner	TS	256
	560		560	Inner	TDO	524
	560		560	Inner	TS	254
	560		560	Inner	TSF	462
	562	X	562X	Outer	TS	244
	562	X	562X	Outer	TS	264
	562	X	562X	Outer	TS	268
	562		562	Outer	TS	256
	562		562	Outer	TS	268
	563	-B	563-B	Outer	TSF	460
	563	-B	563-B	Outer	TSF	462
	563	-B	563-B	Outer	TSF	464
	563	-B	563-B	Outer	TSF	466
	563	D	563D	Outer	TDO	524
	563	D	563D	Outer	TDO	526
	563	D	563D	Outer	TDO	528
	563	D	563D	Outer	TDO	530
	563	D	563D	Outer	TNA	640
	563	D	563D	Outer	TNA	642

Prefix	Base	Suffix	Part Number Prefix + Base + Suffix	Part Type	Type	Page No.
	563	X	563X	Outer	TS	268
	563		563	Outer	TS	244
	563		563	Outer	TS	246
	563		563	Outer	TS	256
	563		563	Outer	TS	260
	563		563	Outer	TS	264
	563		563	Outer	TS	268
	565	-S	565-S	Inner	TS	244
	565		565	Inner	TDO	524
	565		565	Inner	TS	244
	565		565	Inner	TSF	460
	566	-S	566-S	Inner	TS	260
	566		566	Inner	TDO	526
	566		566	Inner	TS	260
	566		566	Inner	TSF	464
NA	567		NA567	Inner	TNA	642
	567	A	567A	Inner	TDO	528
	567	A	567A	Inner	TS	264
	567	A	567A	Inner	TSF	466
	567	-S	567-S	Inner	TDO	528
	567	-S	567-S	Inner	TS	264
	567	X	567X	Inner	TDO	528
	567	X	567X	Inner	TS	268
	567	X	567X	Inner	TSF	466
	567		567	Inner	TDO	528
	567		567	Inner	TS	268
	567		567	Inner	TSF	466
	568		568	Inner	TDO	530
	568		568	Inner	TS	268
	568		568	Inner	TSF	466
NA	569		NA569	Inner	TNA	640
	569		569	Inner	TDO	524
	569		569	Inner	TS	246
	569		569	Inner	TSF	462
	570	X	570X	Inner	TS	264
	570		570	Inner	TDO	526
	570		570	Inner	TS	256
	570		570	Inner	TSF	464
Y4S-	572		Y4S-572	Spacer	2TS-DM	692
	572	-B	572-B	Outer	TSF	466
	572	-B	572-B	Outer	TSF	468
	572	-B	572-B	Outer	TSF	470
	572	D	572D	Outer	TDO	528
	572	D	572D	Outer	TDO	530
	572	D	572D	Outer	TDO	532
	572	D	572D	Outer	TNA	642
	572	D	572D	Outer	TNASWE	654
	572	X	572X	Outer	TS	272
	572	X	572X	Outer	TS	282
	572		572	Outer	2TS-DM	692
	572		572	Outer	TDI	600
	572		572	Outer	TS	268
	572		572	Outer	TS	272
	572		572	Outer	TS	278
	572		572	Outer	TS	280
	572		572	Outer	TS	282

Prefix	Base	Suffix	Part Number Prefix + Base + Suffix	Part Type	Type	Page No.
	574		574	Outer	TS	282
	575	-S	575-S	Inner	TS	272
	575		575	Inner	2TS-DM	692
	575		575	Inner	TDO	530
	575		575	Inner	TS	272
	575		575	Inner	TSF	468
	576		576	Inner	TDO	528
	576		576	Inner	TS	268
	577		577	Inner	TDO	530
	577		577	Inner	TS	268
	577		577	Inner	TSF	466
	578		578	Inner	TDO	532
	578		578	Inner	TS	278
NA	580	SW	NA580SW	Inner	TNASWE	654
NA	580		NA580	Inner	TNA	642
	580	X	580X	Inner	TS	282
	580		580	Inner	TDO	532
	580		580	Inner	TS	282
	580		580	Inner	TSF	470
T	581		T581	Thrust	TTSP	733
	581	D	581D	Inner	TDI	600
	581		581	Inner	TDO	532
	581		581	Inner	TS	280
	581		581	Inner	TSF	468
	582		582	Inner	TDO	532
	582		582	Inner	TS	282
	590	A	590A	Inner	2TS-DM	692
	590	A	590A	Inner	TDO	530
	590	A	590A	Inner	TS	274
	590		590	Inner	TDO	532
	590		590	Inner	TS	278
	590		590	Inner	TSF	468
Y1S-	592	XS	Y1S-592XS	Spacer	2TS-DM	696
Y4S-	592	A	Y4S-592A	Spacer	2TS-DM	692
	592	A	592A	Outer	2TS-DM	692
	592	A	592A	Outer	2TS-IM	670
	592	A	592A	Outer	TS	274
	592	A	592A	Outer	TS	278
	592	A	592A	Outer	TS	284
	592	A	592A	Outer	TS	288
	592	A	592A	Outer	TS	290
	592	A	592A	Outer	TS	294
	592	A	592A	Outer	TS	296
	592	A	592A	Outer	TS	298
	592	A	592A	Outer	TS	300
	592	AS	592AS	Outer	TS	278
	592	AS	592AS	Outer	TS	284
	592	AX	592AX	Outer	TS	288
	592	AX	592AX	Outer	TS	300
	592	-B	592-B	Outer	TSF	468
	592	-B	592-B	Outer	TSF	470
	592	-B	592-B	Outer	TSF	472
	592	-B	592-B	Outer	TSF	474
	592	D	592D	Outer	TDO	530
	592	D	592D	Outer	TDO	532
	592	D	592D	Outer	TDO	534

TAPERED ROLLER BEARINGS

INDEX

Prefix	Base	Suffix	Part Number Prefix + Base + Suffix	Part Type	Type	Page No.
	592	D	592D	Outer	TDO	536
	592	D	592D	Outer	TDO	538
	592	D	592D	Outer	TNA	642
	592	D	592D	Outer	TNASW	650
	592	D	592D	Outer	TNASWE	654
	592	-S	592-S	Outer	TS	296
	592	XE	592XE	Outer	TS	278
	592	XE	592XE	Outer	TS	284
	592	XE	592XE	Outer	TS	292
	592	XE	592XE	Outer	TS	296
	592	XS	592XS	Outer	2TS-DM	696
	592	XS	592XS	Outer	TS	284
	592	XS	592XS	Outer	TS	296
	592	XS	592XS	Outer	TS	300
NA	593	SW	NA593SW	Inner	TNASW	650
NA	593		NA593	Inner	TNA	642
	593	A	593A	Inner	TDO	536
	593	A	593A	Inner	TS	290
	593	-S	593-S	Inner	TS	292
	593	-S	593-S	Inner	TS	294
	593	X	593X	Outer	TS	278
	593	X	593X	Outer	TS	284
	593	X	593X	Outer	TS	288
	593	X	593X	Outer	TS	290
	593	X	593X	Outer	TS	294
	593	X	593X	Outer	TS	300
	593		593	Inner	TDO	536
	593		593	Inner	TS	290
	593		593	Inner	TSF	472
J	594	X	J594X	Inner	TS	298
X4S-	594		X4S-594	Spacer	2TS-IM	670
	594	A	594A	Inner	TDO	538
	594	A	594A	Inner	TS	300
	594	AA	594AA	Inner	TS	300
	594		594	Inner	2TS-DM	696
	594		594	Inner	2TS-IM	670
	594		594	Inner	TDO	538
	594		594	Inner	TS	300
	594		594	Inner	TSF	474
	595	A	595A	Inner	TDO	532
	595	A	595A	Inner	TS	278
	595	A	595A	Inner	TSF	468
	595		595	Inner	TDO	532
	595		595	Inner	TS	284
	595		595	Inner	TSF	470
NA	596	SW	NA596SW	Inner	TNASWE	654
	596	-S	596-S	Inner	TDO	534
	596	-S	596-S	Inner	TS	290
	596	-S	596-S	Inner	TSF	472
	596		596	Inner	TDO	534
	596		596	Inner	TS	288
	596		596	Inner	TSF	472
	597	X	597X	Inner	TS	294
	597		597	Inner	TDO	538
	597		597	Inner	TS	298
	597		597	Inner	TSF	474

Prefix	Base	Suffix	Part Number Prefix + Base + Suffix	Part Type	Type	Page No.
	598	A	598A	Inner	TS	296
	598	X	598X	Inner	TDO	538
	598	X	598X	Inner	TS	296
	598		598	Inner	TDO	538
	598		598	Inner	TS	296
	598		598	Inner	TSF	474
T	600	W	T600W	Thrust	TTC	736
T	600		T600	Thrust	TTC	736
T	611		T611	Thrust	TTHD	727
	612	A	612A	Outer	TS	222
	612	-B	612-B	Outer	TSF	442
	612	-B	612-B	Outer	TSF	446
	612	-B	612-B	Outer	TSF	450
	612	-B	612-B	Outer	TSF	452
	612	-B	612-B	Outer	TSF	454
	612	-B	612-B	Outer	TSF	456
	612	-S	612-S	Outer	TS	218
	612	-S	612-S	Outer	TS	228
	612		612	Outer	TS	158
	612		612	Outer	TS	184
	612		612	Outer	TS	196
	612		612	Outer	TS	210
	612		612	Outer	TS	218
	612		612	Outer	TS	228
	614	X	614X	Outer	TS	222
	615		615	Inner	TS	184
	615		615	Inner	TSF	446
	617		617	Inner	TS	196
	617		617	Inner	TSF	450
	619		619	Inner	TS	210
	619		619	Inner	TSF	452
	620		620	Inner	TS	158
	620		620	Inner	TSF	442
	621		621	Inner	TS	218
	621		621	Inner	TSF	454
	622	A	622A	Inner	TS	222
	622	X	622X	Inner	TS	222
	623	A	623A	Inner	TS	228
	623		623	Inner	TS	228
	623		623	Inner	TSF	456
	624		624	Inner	TS	218
	632	-B	632-B	Outer	TSF	454
	632	-B	632-B	Outer	TSF	456
	632	-B	632-B	Outer	TSF	460
	632	-B	632-B	Outer	TSF	462
	632	-B	632-B	Outer	TSF	464
	632	-B	632-B	Outer	TSF	466
	632	D	632D	Outer	TDO	520
	632	D	632D	Outer	TDO	522
	632	D	632D	Outer	TDO	524
	632	D	632D	Outer	TDO	526
	632	D	632D	Outer	TDO	528
	632	D	632D	Outer	TNA	640
	632	D	632D	Outer	TNASW	650
	632		632	Outer	TS	218
	632		632	Outer	TS	230

Prefix	Base	Suffix	Part Number Prefix + Base + Suffix	Part Type	Type	Page No.
	632		632	Outer	TS	236
	632		632	Outer	TS	246
	632		632	Outer	TS	254
	632		632	Outer	TS	258
	632		632	Outer	TS	260
	632		632	Outer	TS	266
	633	X	633X	Outer	TS	244
	633		633	Outer	TS	236
	633		633	Outer	TS	244
	633		633	Outer	TS	254
	633		633	Outer	TS	256
	633		633	Outer	TS	260
	633		633	Outer	TS	266
	635		635	Inner	TDO	520
	635		635	Inner	TS	230
	635		635	Inner	TSF	456
	636		636	Inner	TS	218
	636		636	Inner	TSF	454
	637		637	Inner	TDO	522
	637		637	Inner	TS	236
	637		637	Inner	TSF	460
	639		639	Inner	TDO	524
	639		639	Inner	TS	244
	639		639	Inner	TS	246
	639		639	Inner	TSF	460
	641		641	Inner	TDO	524
	641		641	Inner	TS	254
	641		641	Inner	TSF	462
	642		642	Inner	TDO	526
	642		642	Inner	TS	256
	642		642	Inner	TS	258
	642		642	Inner	TSF	464
NA	643	SW	NA643SW	Inner	TNASW	650
NA	643		NA643	Inner	TNA	640
	643		643	Inner	TDO	526
	643		643	Inner	TS	260
	643		643	Inner	TSF	464
	644		644	Inner	TDO	528
	644		644	Inner	TS	266
	645	X	645X	Inner	TS	266
	645		645	Inner	TDO	528
	645		645	Inner	TS	266
	645		645	Inner	TSF	466
	652	A	652A	Outer	TS	246
	652	-B	652-B	Outer	TSF	464
	652	-B	652-B	Outer	TSF	466
	652	-B	652-B	Outer	TSF	470
	652	-B	652-B	Outer	TSF	472
	652		652	Outer	TS	262
	652		652	Outer	TS	268
	652		652	Outer	TS	274
	652		652	Outer	TS	278
	652		652	Outer	TS	284
	652		652	Outer	TS	286
	652		652	Outer	TS	288
Y1S-	653		Y1S-653	Spacer	2TS-DM	692

Prefix	Base	Suffix	Part Number Prefix + Base + Suffix	Part Type	Type	Page No.
	653	X	653X	Outer	TS	286
	653		653	Outer	2TS-DM	692
	653		653	Outer	TS	260
	653		653	Outer	TS	268
	653		653	Outer	TS	272
	653		653	Outer	TS	278
	653		653	Outer	TS	280
	653		653	Outer	TS	284
	653		653	Outer	TS	286
	653		653	Outer	TS	288
	654	D	654D	Outer	TDO	526
	654	D	654D	Outer	TDO	528
	654	D	654D	Outer	TDO	530
	654	D	654D	Outer	TDO	532
	654	D	654D	Outer	TDO	534
	654	D	654D	Outer	TNA	642
	654	D	654D	Outer	TNASW	650
	655		655	Inner	2TS-DM	692
	655		655	Inner	TDO	526
	655		655	Inner	TS	260
	655		655	Inner	TS	262
	655		655	Inner	TSF	464
	656		656	Inner	TS	246
	657		657	Inner	TDO	528
	657		657	Inner	TS	268
	657		657	Inner	TSF	466
	658		658	Inner	TS	268
NA	659	SW	NA659SW	Inner	TNASW	650
NA	659		NA659	Inner	TNA	642
	659		659	Inner	2TS-DM	692
	659		659	Inner	TDO	530
	659		659	Inner	TS	272
	659		659	Inner	TS	274
T	660	V	T660V	Thrust	TTHDFL	728
T	661		T661	Thrust	TTHD	727
	661		661	Inner	TS	278
	662		662	Inner	TDO	532
	662		662	Inner	TS	280
	663	A	663A	Inner	TS	284
	663		663	Inner	TDO	534
	663		663	Inner	TS	284
	663		663	Inner	TSF	470
	664		664	Inner	TDO	534
	664		664	Inner	TS	286
	665	A	665A	Inner	TS	288
	665	X	665X	Inner	TS	286
	665		665	Inner	TDO	534
	665		665	Inner	TS	288
	665		665	Inner	TSF	472
Y13S-	672		Y13S-672	Spacer	2TS-DM	696
Y5S-	672		Y5S-672	Spacer	2TS-IM	670
Y5S-	672		Y5S-672	Spacer	2TS-IM	672
Y6S-	672		Y6S-672	Spacer	2TS-DM	696
Y7S-	672		Y7S-672	Spacer	2TS-IM	670
	672	A	672A	Outer	TS	306
	672	-B	672-B	Outer	TSF	470

TAPERED ROLLER BEARINGS

INDEX

Prefix	Base	Suffix	Part Number Prefix + Base + Suffix	Part Type	Type	Page No.
	672	-B	672-B	Outer	TSF	472
	672	-B	672-B	Outer	TSF	474
	672	-B	672-B	Outer	TSF	476
	672	D	672D	Outer	TDO	534
	672	D	672D	Outer	TDO	536
	672	D	672D	Outer	TDO	538
	672	D	672D	Outer	TDO	540
	672	D	672D	Outer	TDO	542
	672	D	672D	Outer	TNA	642
	672	D	672D	Outer	TNASW	650
	672		672	Outer	2TS-DM	696
	672		672	Outer	2TS-IM	670
	672		672	Outer	2TS-IM	672
	672		672	Outer	TDIT	630
	672		672	Outer	TS	290
	672		672	Outer	TS	292
	672		672	Outer	TS	296
	672		672	Outer	TS	298
	672		672	Outer	TS	300
	672		672	Outer	TS	302
	672		672	Outer	TS	306
	674		674	Outer	TS	306
	674		674	Outer	TS	308
X2S-	677		X2S-677	Spacer	2TS-IM	670
	677		677	Inner	2TS-IM	670
	677		677	Inner	TDO	534
	677		677	Inner	TS	290
	677		677	Inner	TSF	470
	679		679	Inner	TDO	536
	679		679	Inner	TS	292
	679		679	Inner	TSF	472
	681	A	681A	Inner	TS	296
	681		681	Inner	TDO	538
	681		681	Inner	TS	296
	681		681	Inner	TSF	474
	682		682	Inner	TS	298
X3S-	683		X3S-683	Spacer	2TS-IM	670
	683	XA	683XA	Inner	TS	302
	683		683	Inner	2TS-DM	696
	683		683	Inner	2TS-IM	670
	683		683	Inner	TDO	538
	683		683	Inner	TS	300
	683		683	Inner	TSF	474
	685		685	Inner	2TS-DM	696
	685		685	Inner	TDO	540
	685		685	Inner	TS	302
	685		685	Inner	TSF	476
X2S-	687		X2S-687	Spacer	2TS-IM	672
	687		687	Inner	2TS-DM	696
	687		687	Inner	2TS-IM	672
	687		687	Inner	TDO	542
	687		687	Inner	TS	306
	687		687	Inner	TSF	476
	688	TD	688TD	Inner	TDIT	630
	689		689	Inner	TS	308
NA	691	A	NA691A	Inner	TNA	642

Prefix	Base	Suffix	Part Number Prefix + Base + Suffix	Part Type	Type	Page No.
NA	691	SW	NA691SW	Inner	TNASW	650
NA	691		NA691	Inner	TNA	642
T	691		T691	Thrust	TTHD	727
	740		740	Inner	TS	280
	742	-B	742-B	Outer	TSF	458
	742	-B	742-B	Outer	TSF	464
	742	D	742D	Outer	TDO	524
	742	D	742D	Outer	TDO	526
	742	D	742D	Outer	TDO	528
	742	D	742D	Outer	TDO	530
	742	D	742D	Outer	TDO	532
	742	D	742D	Outer	TDO	534
	742	D	742D	Outer	TNA	642
	742		742	Outer	TS	230
	742		742	Outer	TS	246
	742		742	Outer	TS	262
	742		742	Outer	TS	268
	742		742	Outer	TS	274
	742		742	Outer	TS	278
	742		742	Outer	TS	280
	742		742	Outer	TS	284
	742		742	Outer	TS	288
	743		743	Outer	TS	280
	743		743	Outer	TS	288
	744	A	744A	Inner	TDO	526
	744	A	744A	Inner	TS	262
	744		744	Inner	TDO	528
	744		744	Inner	TS	268
	745	A	745A	Inner	TDO	526
	745	A	745A	Inner	TS	262
	745	A	745A	Inner	TSF	464
	745	-S	745-S	Inner	TDO	524
	745	-S	745-S	Inner	TS	246
	745		745	Inner	TS	230
	745		745	Inner	TSF	458
	747	-S	747-S	Inner	TDO	524
	748	-S	748-S	Inner	TDO	530
	748	-S	748-S	Inner	TS	274
	748		748	Inner	TDO	532
	748		748	Inner	TS	280
NA	749		NA749	Inner	TNA	642
	749	A	749A	Inner	TDO	534
	749	A	749A	Inner	TS	284
	749	-S	749-S	Inner	TS	288
	749		749	Inner	TDO	534
	749		749	Inner	TS	288
	750	A	750A	Inner	TS	284
	750		750	Inner	TS	278
Y8S-	752		Y8S-752	Spacer	2TS-DM	694
	752	A	752A	Outer	TS	284
	752	A	752A	Outer	TS	292
	752	-B	752-B	Outer	TSF	466
	752	-B	752-B	Outer	TSF	470
	752	-B	752-B	Outer	TSF	472
	752	-B	752-B	Outer	TSF	474
	752	D	752D	Outer	TDO	530

Prefix	Base	Suffix	Part Number Prefix + Base + Suffix	Part Type	Type	Page No.
	752	D	752D	Outer	TDO	534
	752	D	752D	Outer	TDO	536
	752	D	752D	Outer	TNA	642
	752	D	752D	Outer	TNASW	650
	752		752	Outer	2TS-DM	694
	752		752	Outer	TDI	602
	752		752	Outer	TS	274
	752		752	Outer	TS	278
	752		752	Outer	TS	284
	752		752	Outer	TS	288
	752		752	Outer	TS	292
	752		752	Outer	TS	294
	753		753	Outer	TS	274
	753		753	Outer	TS	284
	753		753	Outer	TS	292
	753		753	Outer	TS	294
	755		755	Inner	2TS-DM	694
	755		755	Inner	TDO	530
	755		755	Inner	TS	274
	755		755	Inner	TSF	466
	756	A	756A	Inner	TS	278
	757		757	Inner	TDO	534
	757		757	Inner	TS	284
	757		757	Inner	TSF	470
	758		758	Inner	TDO	534
	758		758	Inner	TS	288
	758		758	Inner	TSF	472
NA	759	SW	NA759SW	Inner	TNASW	650
NA	759		NA759	Inner	TNA	642
	759		759	Inner	TDO	536
	759		759	Inner	TS	292
	759		759	Inner	TSF	472
	760		760	Inner	TDO	536
	760		760	Inner	TS	294
	760		760	Inner	TSF	474
	766		766	Inner	TS	292
	766		766	Inner	TSF	472
	767	D	767D	Inner	TDI	602
	772	-B	772-B	Outer	TSF	472
	772	-B	772-B	Outer	TSF	474
	772	-B	772-B	Outer	TSF	476
	772	-B	772-B	Outer	TSF	478
	772		772	Outer	TDI	602
	772		772	Outer	TS	292
	772		772	Outer	TS	296
	772		772	Outer	TS	302
	772		772	Outer	TS	304
	772		772	Outer	TS	306
	772		772	Outer	TS	308
	773	D	773D	Outer	TDO	540
	773	D	773D	Outer	TDO	542
	773	D	773D	Outer	TNA	642
	773	D	773D	Outer	TNASW	650
	773		773	Outer	TS	304
	773		773	Outer	TS	306
	774	CD	774CD	Outer	TDO	542

Prefix	Base	Suffix	Part Number Prefix + Base + Suffix	Part Type	Type	Page No.
	774	CD	774CD	Outer	TNA	642
	774	CD	774CD	Outer	TNA	644
	774	D	774D	Outer	TDO	536
	774	D	774D	Outer	TDO	538
	774	D	774D	Outer	TDO	540
	774	D	774D	Outer	TDO	542
	774	D	774D	Outer	TDO	544
	774	D	774D	Outer	TNASW	650
	775		775	Inner	TDO	536
	775		775	Inner	TS	292
	775		775	Inner	TSF	472
NA	776	SW	NA776SW	Inner	TNASW	650
NA	776		NA776	Inner	TNA	642
	776		776	Inner	TDO	538
	776		776	Inner	TS	302
	776		776	Inner	TSF	474
	777		777	Inner	TSF	474
	778		778	Inner	TDO	538
	778		778	Inner	TS	296
	779	D	779D	Inner	TDI	602
	779		779	Inner	TDO	540
	779		779	Inner	TS	302
	779		779	Inner	TSF	476
NA	780		NA780	Inner	TNA	642
	780		780	Inner	TDO	542
	780		780	Inner	TS	306
	780		780	Inner	TSF	476
NA	782		NA782	Inner	TNA	644
	782	D	782D	Inner	TDI	602
	782		782	Inner	TDO	542
	782		782	Inner	TDO	544
	782		782	Inner	TS	308
	782		782	Inner	TSF	478
	783		783	Inner	TDO	540
	783		783	Inner	TS	304
	783		783	Inner	TSF	476
	786		786	Inner	TDO	542
	786		786	Inner	TS	308
	787		787	Inner	TDO	542
	787		787	Inner	TS	308
Y3S-	792		Y3S-792	Spacer	2TS-DM	698
Y4S-	792		Y4S-792	Spacer	2TS-DM	700
	792	CD	792CD	Outer	TDO	546
	792	CD	792CD	Outer	TDO	548
	792		792	Outer	2TS-DM	698
	792		792	Outer	2TS-DM	700
	792		792	Outer	TS	318
	792		792	Outer	TS	320
	792		792	Outer	TS	322
	795		795	Inner	2TS-DM	698
	795		795	Inner	TDO	546
	795		795	Inner	TS	318
	797		797	Inner	2TS-DM	700
	797		797	Inner	TDO	548
	797		797	Inner	TS	322
	798		798	Inner	TDO	548

TAPERED ROLLER BEARINGS

INDEX

Prefix	Base	Suffix	Part Number Prefix + Base + Suffix	Part Type	Type	Page No.
	799	A	799A	Inner	TDO	548
	799	A	799A	Inner	TS	322
	799		799	Inner	TDO	548
	799		799	Inner	TS	320
T	811		T811	Thrust	TTHD	727
Y3S-	832		Y3S-832	Spacer	2TS-IM	670
	832	-B	832-B	Outer	TSF	464
	832	-B	832-B	Outer	TSF	466
	832	-B	832-B	Outer	TSF	468
	832	-B	832-B	Outer	TSF	470
	832	-B	832-B	Outer	TSF	472
	832		832	Outer	2TS-IM	670
	832		832	Outer	TS	262
	832		832	Outer	TS	274
	832		832	Outer	TS	280
	832		832	Outer	TS	284
	832		832	Outer	TS	290
	832		832	Outer	TS	292
	832		832	Outer	TS	294
	834	D	834D	Outer	TDO	526
	834	D	834D	Outer	TDO	530
	834	D	834D	Outer	TDO	534
	834	D	834D	Outer	TDO	536
	834	D	834D	Outer	TNA	642
	835		835	Inner	TDO	526
	835		835	Inner	TS	262
	835		835	Inner	TSF	464
	837		837	Inner	TDO	530
	837		837	Inner	TS	274
	837		837	Inner	TSF	466
	838		838	Inner	TS	280
	838		838	Inner	TSF	468
	839		839	Inner	TS	284
	839		839	Inner	TSF	470
	841		841	Inner	TDO	534
	841		841	Inner	TS	290
	841		841	Inner	TSF	472
NA	842		NA842	Inner	TNA	642
	842		842	Inner	TDO	534
	842		842	Inner	TS	284
	842		842	Inner	TSF	470
	843		843	Inner	TDO	530
	843		843	Inner	TS	274
X4S-	850		X4S-850	Spacer	2TS-IM	670
	850	A	850A	Inner	TDO	536
	850	A	850A	Inner	TS	294
	850		850	Inner	2TS-IM	670
	850		850	Inner	TDO	536
	850		850	Inner	TS	292
	853		853	Outer	TS	298
Y12S-	854		Y12S-854	Spacer	2TS-IM	672
Y14S-	854		Y14S-854	Spacer	2TS-IM	672
	854	-B	854-B	Outer	TSF	472
	854	-B	854-B	Outer	TSF	474
	854	-B	854-B	Outer	TSF	476
	854	D	854D	Outer	TDO	536

Prefix	Base	Suffix	Part Number Prefix + Base + Suffix	Part Type	Type	Page No.
	854	D	854D	Outer	TDO	540
	854	D	854D	Outer	TDO	542
	854	D	854D	Outer	TNA	644
	854		854	Outer	2TS-IM	672
	854		854	Outer	TS	292
	854		854	Outer	TS	298
	854		854	Outer	TS	302
	854		854	Outer	TS	308
	855		855	Inner	TDO	536
	855		855	Inner	TS	292
	855		855	Inner	TSF	472
	857		857	Inner	TS	298
NA	861		NA861	Inner	TNA	644
X8S-	861		X8S-861	Spacer	2TS-IM	672
X9S-	861		X9S-861	Spacer	2TS-IM	672
	861		861	Inner	2TS-IM	672
	861		861	Inner	TDO	542
	861		861	Inner	TS	308
	861		861	Inner	TSF	476
	862		862	Inner	TS	298
	864		864	Inner	TS	302
	864		864	Inner	TSF	474
	866		866	Inner	TDO	540
Y5S-	892		Y5S-892	Spacer	2TS-IM	676
	892	CD	892CD	Outer	TDO	550
	892		892	Outer	2TS-IM	676
	892		892	Outer	TS	324
	896		896	Inner	TDO	550
	896		896	Inner	TS	324
X4S-	898		X4S-898	Spacer	2TS-IM	676
	898	A	898A	Inner	TDO	550
	898	A	898A	Inner	TS	324
	898		898	Inner	2TS-IM	676
	898		898	Inner	TDO	550
	898		898	Inner	TS	324
T	911		T911	Thrust	TTHD	727
XC	914	-SD	XC914-SD	Spacer	2S	714
	930		930	Outer	TS	314
Y10S-	932		Y10S-932	Spacer	2TS-IM	674
Y14S-	932		Y14S-932	Spacer	2TS-IM	674
Y1S-	932		Y1S-932	Spacer	2TS-DM	696
Y1S-	932		Y1S-932	Spacer	2TS-DM	698
Y6S-	932		Y6S-932	Spacer	2TS-DM	698
	932	-B	932-B	Outer	TSF	476
	932	-B	932-B	Outer	TSF	478
	932	CD	932CD	Outer	TDO	540
	932	CD	932CD	Outer	TDO	542
	932	CD	932CD	Outer	TDO	544
	932	CD	932CD	Outer	TDO	546
	932		932	Outer	2TS-DM	696
	932		932	Outer	2TS-DM	698
	932		932	Outer	2TS-IM	674
	932		932	Outer	TDI	602
	932		932	Outer	TS	308
	932		932	Outer	TS	310
	932		932	Outer	TS	312

Prefix	Base	Suffix	Part Number Prefix + Base + Suffix	Part Type	Type	Page No.
	932		932	Outer	TS	314
	936		936	Inner	2TS-DM	698
	936		936	Inner	TDO	544
	936		936	Inner	TS	310
	936		936	Inner	TSF	478
X7S-	938		X7S-938	Spacer	2TS-IM	674
X9S-	938		X9S-938	Spacer	2TS-IM	674
	938		938	Inner	2TS-DM	698
	938		938	Inner	2TS-IM	674
	938		938	Inner	TDO	546
	938		938	Inner	TS	314
	938		938	Inner	TSF	478
	941		941	Inner	2TS-DM	696
	941		941	Inner	TDO	542
	941		941	Inner	TS	308
	941		941	Inner	TSF	476
	942		942	Inner	TS	312
	943		943	Inner	TDO	540
	946	D	946D	Inner	TDI	602
	1220		1220	Outer	TS	96
T	1260	W	T1260W	Thrust	TTC	736
T	1260		T1260	Thrust	TTC	736
	1280		1280	Inner	TS	96
	1328		1328	Outer	TS	96
	1329		1329	Outer	TS	96
T	1380		T1380	Thrust	TTC	736
	1380		1380	Inner	TS	96
T	1421		T1421	Thrust	TTHD	727
	1620		1620	Outer	TS	118
	1620		1620	Outer	TS	126
	1674		1674	Inner	TS	118
	1680		1680	Inner	TS	126
H-	1685	-C	H-1685-C	Thrust	TTVS	730
	1729	-B	1729-B	Outer	TSF	424
	1729	-B	1729-B	Outer	TSF	426
	1729	X	1729X	Outer	TS	90
	1729	X	1729X	Outer	TS	96
	1729		1729	Outer	TS	90
	1729		1729	Outer	TS	94
	1729		1729	Outer	TS	96
	1729		1729	Outer	TS	98
	1729		1729	Outer	TS	100
	1730		1730	Outer	TS	96
	1730		1730	Outer	TS	98
	1730		1730	Outer	TS	100
	1738	X	1738X	Outer	TS	100
P-	1739	-C	P-1739-C	Thrust	TTVS	730
T	1750		T1750	Thrust	TTHD	727
	1755		1755	Inner	TS	96
	1755		1755	Inner	TSF	426
T	1760		T1760	Thrust	TTSP	733
	1774		1774	Inner	TS	90
	1775		1775	Inner	TS	94
	1775		1775	Inner	TSF	424
	1778		1778	Inner	TS	94
	1779		1779	Inner	TS	98

Prefix	Base	Suffix	Part Number Prefix + Base + Suffix	Part Type	Type	Page No.
	1779		1779	Inner	TSF	426
	1780		1780	Inner	TS	100
T	1921		T1921	Thrust	TTC	736
	1922		1922	Outer	TS	96
	1922		1922	Outer	TS	100
	1922		1922	Outer	TS	106
	1922		1922	Outer	TS	108
	1930		1930	Outer	TS	106
	1931	-B	1931-B	Outer	TSF	426
	1931	-B	1931-B	Outer	TSF	428
	1931		1931	Outer	TS	96
	1931		1931	Outer	TS	102
	1931		1931	Outer	TS	106
	1931		1931	Outer	TS	108
	1931		1931	Outer	TS	108
	1931		1931	Outer	TS	108
	1932	-B	1932-B	Outer	TSF	428
	1932		1932	Outer	TS	96
	1932		1932	Outer	TS	102
	1932		1932	Outer	TS	106
	1932		1932	Outer	TS	108
	1932		1932	Outer	TS	108
	1975		1975	Inner	TS	96
	1975		1975	Inner	TSF	426
	1985		1985	Inner	TS	106
	1985		1985	Inner	TS	108
	1985		1985	Inner	TSF	428
	1986		1986	Inner	TS	100
	1986		1986	Inner	TS	102
	1986		1986	Inner	TSF	428
	1987		1987	Inner	TS	106
	1987		1987	Inner	TSF	428
E-	1994	-C	E-1994-C	Thrust	TTHDFL	729
	1994	X	1994X	Inner	TS	100
	1994	X	1994X	Inner	TS	102
	1997	X	1997X	Inner	TS	106
E-	2004	-C	E-2004-C	Thrust	TTVS	730
A	2031		A2031	Inner	TS	88
A	2031		A2031	Inner	TSF	424
A	2037		A2037	Inner	TS	88
A	2037		A2037	Inner	TSF	424
A	2047		A2047	Inner	TDO	500
A	2047		A2047	Inner	TS	88
A	2047		A2047	Inner	TSF	424
H-	2054	-G	H-2054-G	Thrust	TTHDFL	729
I-	2060	-C	I-2060-C	Thrust	TTHDFL	729
I-	2077	-C	I-2077-C	Thrust	TTHDFL	728
A	2120	D	A2120D	Outer	TDO	500
A	2126	-B	A2126-B	Outer	TSF	424
A	2126		A2126	Outer	TS	88
XC	2360	-SA	XC2360-SA	Spacer	2TS-IM	660
	2419		02419	Outer	TS	106
	2419		02419	Outer	TS	124
	2420	A	02420A	Outer	TS	112
	2420	A	02420A	Outer	TS	120
	2420	-B	02420-B	Outer	TSF	428
	2420	-B	02420-B	Outer	TSF	430
	2420	-B	02420-B	Outer	TSF	432
	2420		2420	Outer	TS	104

TAPERED ROLLER BEARINGS

INDEX

Prefix	Base	Suffix	Part Number Prefix + Base + Suffix	Part Type	Type	Page No.
	2420		02420	Outer	TS	104
	2420		2420	Outer	TS	108
	2420		02420	Outer	TS	108
	2420		2420	Outer	TS	120
	2420		02420	Outer	TS	120
	2473	X	02473X	Inner	TS	106
	2473		2473	Inner	TS	104
	2473		02473	Inner	TS	104
	2473		02473	Inner	TSF	428
	2474	A	02474A	Inner	TS	112
	2474	A	02474A	Inner	TSF	430
	2474		2474	Inner	TS	108
	2474		02474	Inner	TS	108
	2475		2475	Inner	TS	120
	2475		02475	Inner	TS	120
	2475		02475	Inner	TSF	432
	2476	X	02476X	Inner	TS	124
	2476		02476	Inner	TS	120
	2476		02476	Inner	TSF	432
	2520	A	2520A	Outer	TS	120
	2520		2520	Outer	TS	118
	2520		2520	Outer	TS	120
	2520		2520	Outer	TS	126
	2523	-B	2523-B	Outer	TSF	428
	2523	-B	2523-B	Outer	TSF	430
	2523	-B	2523-B	Outer	TSF	432
	2523	-B	2523-B	Outer	TSF	434
	2523	D	2523D	Outer	TDO	504
	2523	-S	2523-S	Outer	TS	110
	2523	-S	2523-S	Outer	TS	114
	2523	-S	2523-S	Outer	TS	116
	2523	-S	2523-S	Outer	TS	118
	2523	-S	2523-S	Outer	TS	122
	2523	-S	2523-S	Outer	TS	126
	2523	-S	2523-S	Outer	TS	128
	2523		2523	Outer	TS	110
	2523		2523	Outer	TS	114
	2523		2523	Outer	TS	116
	2523		2523	Outer	TS	118
	2523		2523	Outer	TS	122
	2523		2523	Outer	TS	126
	2524	YD	2524YD	Outer	TDO	504
	2525		2525	Outer	TS	114
	2525		2525	Outer	TS	122
	2526	X	2526X	Outer	TS	114
	2530		2530	Outer	TS	116
	2530		2530	Outer	TS	120
	2558		2558	Inner	TS	116
	2558		2558	Inner	TSF	430
	2560	X	2560X	Inner	TS	114
	2561	X	2561X	Inner	TS	118
	2578		2578	Inner	TS	110
	2578		2578	Inner	TSF	428
	2580	A	2580A	Inner	TS	120
	2580		2580	Inner	TDO	504
	2580		2580	Inner	TS	120

Prefix	Base	Suffix	Part Number Prefix + Base + Suffix	Part Type	Type	Page No.
	2580		2580	Inner	TS	122
	2580		2580	Inner	TSF	432
	2581		2581	Inner	TS	126
	2581		2581	Inner	TS	128
	2581		2581	Inner	TSF	434
	2582		2582	Inner	TS	122
	2582		2582	Inner	TSF	432
	2584		2584	Inner	TS	126
	2585		2585	Inner	TDO	504
	2585		2585	Inner	TS	126
	2585		2585	Inner	TSF	434
	2586		2586	Inner	TS	114
	2630		2630	Outer	TS	102
	2630		2630	Outer	TS	108
	2631	-B	2631-B	Outer	TSF	426
	2631	-B	2631-B	Outer	TSF	428
	2631	-B	2631-B	Outer	TSF	430
	2631		2631	Outer	TS	96
	2631		2631	Outer	TS	98
	2631		2631	Outer	TS	104
	2631		2631	Outer	TS	106
	2631		2631	Outer	TS	108
	2631		2631	Outer	TS	110
	2682		2682	Inner	TS	106
	2684		2684	Inner	TS	96
	2684		2684	Inner	TSF	426
	2685		2685	Inner	TS	98
	2687		2687	Inner	TS	102
	2687		2687	Inner	TS	104
	2687		2687	Inner	TSF	428
	2688		2688	Inner	TS	106
	2688		2688	Inner	TSF	428
	2689		2689	Inner	TS	108
	2689		2689	Inner	TSF	428
	2690		2690	Inner	TS	110
	2690		2690	Inner	TSF	430
	2691		2691	Inner	TS	110
	2691		2691	Inner	TSF	430
	2720	-B	2720-B	Outer	TSF	436
	2720	-B	2720-B	Outer	TSF	440
	2720		2720	Outer	TS	124
	2720		2720	Outer	TS	128
	2720		2720	Outer	TS	134
	2720		2720	Outer	TS	142
	2720		2720	Outer	TS	150
	2720		2720	Outer	TS	156
	2729	X	2729X	Outer	TS	150
	2729		2729	Outer	TS	128
	2729		2729	Outer	TS	134
	2729		2729	Outer	TS	142
	2729		2729	Outer	TS	150
	2729		2729	Outer	TS	156
	2731		2731	Outer	TS	142
	2734		2734	Outer	TS	150
	2735	X	2735X	Outer	TS	128
	2735	X	2735X	Outer	TS	134

Prefix	Base	Suffix	Part Number Prefix + Base + Suffix	Part Type	Type	Page No.
	2735	X	2735X	Outer	TS	142
	2735	X	2735X	Outer	TS	148
	2735	X	2735X	Outer	TS	156
	2736		2736	Outer	TS	142
	2736		2736	Outer	TS	148
	2776		2776	Inner	TS	148
	2776		2776	Inner	TS	150
	2777		2777	Inner	TS	150
	2780		2780	Inner	TS	142
	2783		2783	Inner	TS	124
	2785		2785	Inner	TS	128
	2786		2786	Inner	TS	134
	2786		2786	Inner	TSF	436
	2788	A	2788A	Inner	TS	148
	2788	A	2788A	Inner	TS	150
	2788		2788	Inner	TS	148
	2788		2788	Inner	TS	150
	2788		2788	Inner	TSF	440
	2789		2789	Inner	TS	156
	2790		2790	Inner	TS	128
	2793		2793	Inner	TS	134
	2793		2793	Inner	TSF	436
	2794		2794	Inner	TS	142
	2796		2796	Inner	TS	134
	2796		2796	Inner	TSF	436
	2820		02820	Outer	TS	110
	2820		2820	Outer	TS	122
	2820		02820	Outer	TS	122
	2820		02820	Outer	TS	124
	2820		2820	Outer	TS	124
	2820		2820	Outer	TS	132
	2820		02820	Outer	TS	132
	2820		2820	Outer	TS	134
	2820		02820	Outer	TS	134
	2820		2820	Outer	TS	142
	2821		2821	Outer	TS	134
	2823	D	02823D	Outer	TDO	502
	2823	D	02823D	Outer	TDO	504
N-	2827	-G	N-2827-G	Thrust	TTVVS	730
	2830		02830	Outer	TS	110
	2830		02830	Outer	TS	134
	2831		02831	Outer	TS	136
D-	2864	-C	D-2864-C	Thrust	TTHDFL	729
	2872		02872	Inner	TDO	502
	2872		02872	Inner	TS	110
	2875		02875	Inner	TDO	504
	2875		2875	Inner	TS	122
	2875		02875	Inner	TS	122
	2876		02876	Inner	TS	124
	2877		02877	Inner	TDO	504
	2877		2877	Inner	TS	132
	2877		02877	Inner	TS	132
	2877		02877	Inner	TS	136
	2878		02878	Inner	TDO	504
	2878		2878	Inner	TS	134
	2878		02878	Inner	TS	134

Prefix	Base	Suffix	Part Number Prefix + Base + Suffix	Part Type	Type	Page No.
	2878		2878	Inner	TS	134
	2878		02878	Inner	TS	134
	2879		2879	Inner	TS	124
	2880		2880	Inner	TS	142
	2924	-B	2924-B	Outer	TSF	446
	2924	-B	2924-B	Outer	TSF	450
	2924		2924	Outer	TS	176
	2924		2924	Outer	TS	190
	2925		2925	Outer	TS	176
	2925		2925	Outer	TS	190
R-	2927	-C	R-2927-C	Thrust	TTHDFL	728
	2973		2973	Inner	TSF	446
	2975		2975	Inner	TS	176
	2984	A	2984A	Inner	TS	190
	2984		2984	Inner	TS	190
	2984		2984	Inner	TSF	450
	3062		03062	Inner	TS	88
F-	3067	-C	F-3067-C	Thrust	TTHDFL	729
F-	3090	-A	F-3090-A	Thrust	TTHDFL	729
F-	3093	-A	F-3093-A	Thrust	TTHDFL	729
F-	3094	-C	F-3094-C	Thrust	TTHDFL	728
W-	3120	-C	W-3120-C	Thrust	TTVVS	730
	3120	-B	3120-B	Outer	TSF	426
	3120	-B	3120-B	Outer	TSF	428
	3120	-B	3120-B	Outer	TSF	430
	3120	-B	3120-B	Outer	TSF	432
	3120	-B	3120-B	Outer	TSF	434
	3120		3120	Outer	TS	104
	3120		3120	Outer	TS	110
	3120		3120	Outer	TS	116
	3120		3120	Outer	TS	122
	3120		3120	Outer	TS	128
	3126		3126	Outer	TS	114
	3129		3129	Outer	TS	110
	3129		3129	Outer	TS	124
F-	3131	-G	F-3163-C	Thrust	TTHDFL	729
F-	3131	-G	F-3131-G	Thrust	TTHDFL	729
	3162		03162	Outer	TS	88
F-	3167	-B	F-3167-B	Thrust	TTHDFL	728
F-	3172	-C	F-3172-C	Thrust	TTHDFL	729
	3187		3187	Inner	TS	116
	3187		3187	Inner	TSF	430
	3188		3188	Inner	TS	122
	3188		3188	Inner	TS	124
	3188		3188	Inner	TSF	432
	3189		3189	Inner	TS	104
	3189		3189	Inner	TSF	426
	3190		3190	Inner	TS	114
	3190		3190	Inner	TSF	430
	3191		3191	Inner	TS	116
	3191		3191	Inner	TSF	430
	3192		3192	Inner	TS	110
	3192		3192	Inner	TSF	428
	3193		3193	Inner	TS	122
	3193		3193	Inner	TS	124
	3193		3193	Inner	TSF	432

TAPERED ROLLER BEARINGS

INDEX

Prefix	Base	Suffix	Part Number Prefix + Base + Suffix	Part Type	Type	Page No.
	3196		3196	Inner	TS	128
	3196		3196	Inner	TSF	434
	3197		3197	Inner	TS	128
	3197		3197	Inner	TSF	434
	3198		3198	Inner	TS	110
	3198		3198	Inner	TSF	428
	3199		3199	Inner	TS	122
	3199		3199	Inner	TSF	432
W-	3217	-B	W-3217-B	Thrust	TTHDFL	728
W-	3218	-B	W-3218-B	Thrust	TTHDFL	728
G-	3224	-C	G-3224-C	Thrust	TTHDFL	728
G-	3272	-C	G-3272-C	Thrust	TTHDFL	729
G-	3304	-B	G-3304-B	Thrust	TTHDFL	728
	3320	-B	3320-B	Outer	TSF	436
	3320	-B	3320-B	Outer	TSF	440
	3320	-B	3320-B	Outer	TSF	442
	3320	-B	3320-B	Outer	TSF	444
	3320		3320	Outer	TS	124
	3320		3320	Outer	TS	130
	3320		3320	Outer	TS	136
	3320		3320	Outer	TS	152
	3320		3320	Outer	TS	158
	3320		3320	Outer	TS	164
	3325		3325	Outer	TS	150
	3325		3325	Outer	TS	156
	3328		3328	Outer	TS	138
	3328		3328	Outer	TS	158
	3328		3328	Outer	TS	166
	3329	-B	3329-B	Outer	TSF	436
	3329	-B	3329-B	Outer	TSF	440
	3329	-B	3329-B	Outer	TSF	442
	3329	-B	3329-B	Outer	TSF	444
	3329		3329	Outer	TS	138
	3329		3329	Outer	TS	152
	3329		3329	Outer	TS	164
	3331		3331	Outer	TS	152
	3331		3331	Outer	TS	158
	3339		3339	Outer	2TS-IM	660
	3339		3339	Outer	TS	136
	3339		3339	Outer	TS	152
	3339		3339	Outer	TS	158
	3339		3339	Outer	TS	164
	3379		3379	Inner	TS	136
	3379		3379	Inner	TS	138
	3379		3379	Inner	TSF	436
	3381		3381	Inner	TS	152
	3381		3381	Inner	TSF	440
X1S-	3382		X1S-3382	Spacer	2TS-IM	660
	3382		3382	Inner	2TS-IM	660
	3382		3382	Inner	TS	156
	3382		3382	Inner	TS	158
	3382		3382	Inner	TSF	442
	3383		3383	Inner	TS	164
	3383		3383	Inner	TS	166
	3383		3383	Inner	TSF	444
	3386		3386	Inner	TS	156

Prefix	Base	Suffix	Part Number Prefix + Base + Suffix	Part Type	Type	Page No.
	3386		3386	Inner	TS	158
	3386		3386	Inner	TSF	442
	3387		3387	Inner	TS	150
	3387		3387	Inner	TS	152
	3387		3387	Inner	TSF	440
	3420	-B	3420-B	Outer	TSF	430
	3420	-B	3420-B	Outer	TSF	432
	3420	-B	3420-B	Outer	TSF	434
	3420	-B	3420-B	Outer	TSF	436
	3420	-B	3420-B	Outer	TSF	438
	3420	-B	3420-B	Outer	TSF	440
	3420		3420	Outer	2TS-IM	660
	3420		3420	Outer	TS	124
	3420		3420	Outer	TS	130
	3420		3420	Outer	TS	136
	3420		3420	Outer	TS	144
	3420		3420	Outer	TS	150
	3422		3422	Outer	TS	142
	3422		3422	Outer	TS	144
	3423	D	3423D	Outer	TDO	504
	3423	D	3423D	Outer	TDO	506
	3426		3426	Outer	TS	136
	3474		3474	Inner	TSF	430
	3476		3476	Inner	TDO	504
	3476		3476	Inner	TS	124
	3476		3476	Inner	TSF	432
	3477		3477	Inner	TS	130
	3477		3477	Inner	TSF	434
	3478		3478	Inner	TS	136
	3478		3478	Inner	TSF	436
	3479		3479	Inner	TDO	506
	3479		3479	Inner	TS	144
	3479		3479	Inner	TSF	438
	3480		3480	Inner	TS	142
	3480		3480	Inner	TSF	438
	3482		3482	Inner	TS	136
	3482		3482	Inner	TSF	436
	3483		3483	Inner	TS	130
	3483		3483	Inner	TSF	434
	3490		3490	Inner	2TS-IM	660
	3490		3490	Inner	TDO	506
	3490		3490	Inner	TS	150
	3490		3490	Inner	TSF	440
JX	3505	A	JX3505A	Spacer	2TS-IM	660
JS-	3510		JS-3510	Outer	TS	140
	3520		3520	Outer	TS	160
	3520		3520	Outer	TS	166
	3520		3520	Outer	TS	176
	3520		3520	Outer	TS	186
	3520		3520	Outer	TS	190
	3525	-B	3525-B	Outer	TSF	436
	3525	-B	3525-B	Outer	TSF	440
	3525	-B	3525-B	Outer	TSF	444
	3525	-B	3525-B	Outer	TSF	446
	3525	-B	3525-B	Outer	TSF	448
	3525		3525	Outer	TS	138

Prefix	Base	Suffix	Part Number Prefix + Base + Suffix	Part Type	Type	Page No.
	3525		3525	Outer	TS	154
	3525		3525	Outer	TS	160
	3525		3525	Outer	TS	166
	3525		3525	Outer	TS	170
	3525		3525	Outer	TS	176
	3525		3525	Outer	TS	186
	3525		3525	Outer	TS	190
	3526		3526	Outer	TS	176
	3530		3530	Outer	TS	166
JS-	3549	A	JS-3549A	Inner	TS	140
	3576		3576	Inner	TS	166
	3576		3576	Inner	TSF	444
	3577		3577	Inner	TS	166
	3577		3577	Inner	TSF	444
	3578	A	3578A	Inner	TS	176
	3578		3578	Inner	TS	176
	3578		3578	Inner	TSF	446
	3579		3579	Inner	TS	170
	3579		3579	Inner	TSF	446
	3580		3580	Inner	TS	154
	3580		3580	Inner	TSF	440
	3581		3581	Inner	TS	138
	3581		3581	Inner	TSF	436
	3582		3582	Inner	TS	160
	3583		3583	Inner	TS	154
	3583		3583	Inner	TSF	440
	3585		3585	Inner	TS	166
	3585		3585	Inner	TSF	444
	3586		3586	Inner	TS	186
	3586		3586	Inner	TSF	448
	3620	-B	3620-B	Outer	TSF	426
	3620		3620	Outer	TS	96
	3620		3620	Outer	TS	98
	3655		3655	Inner	TS	96
	3659		3659	Inner	TS	98
	3660		3660	Inner	TSF	426
	3720	-B	3720-B	Outer	TSF	448
	3720	-B	3720-B	Outer	TSF	450
	3720	-B	3720-B	Outer	TSF	452
	3720	-B	3720-B	Outer	TSF	454
	3720		3720	Outer	TS	176
	3720		3720	Outer	TS	184
	3720		3720	Outer	TS	190
	3720		3720	Outer	TS	192
	3720		3720	Outer	TS	196
	3720		3720	Outer	TS	202
	3720		3720	Outer	TS	204
	3720		3720	Outer	TS	212
	3726		3726	Outer	TS	178
	3726		3726	Outer	TS	192
	3726		3726	Outer	TS	204
	3727		3727	Outer	TS	204
	3729	D	3729D	Outer	TDO	510
	3729	D	3729D	Outer	TDO	512
	3729	D	3729D	Outer	TDO	514
	3729	D	3729D	Outer	TDO	516

Prefix	Base	Suffix	Part Number Prefix + Base + Suffix	Part Type	Type	Page No.
	3729	D	3729D	Outer	TNA	640
	3729	D	3729D	Outer	TNASW	650
	3730		3730	Outer	2TS-IM	662
	3730		3730	Outer	TS	192
	3730		3730	Outer	TS	204
	3730		3730	Outer	TS	212
	3732		3732	Outer	TS	180
	3732		3732	Outer	TS	192
	3732		3732	Outer	TS	204
	3732		3732	Outer	TS	212
	3767		3767	Inner	TDO	516
	3767		3767	Inner	TS	212
	3767		3767	Inner	TSF	454
	3775		3775	Inner	TDO	514
	3775		3775	Inner	TS	204
	3775		3775	Inner	TSF	452
	3776		3776	Inner	TDO	510
	3776		3776	Inner	TS	184
	3776		3776	Inner	TSF	448
	3777		3777	Inner	TS	190
	3778		3778	Inner	TS	192
	3778		3778	Inner	TSF	450
	3779		3779	Inner	TDO	512
	3779		3779	Inner	TS	192
	3779		3779	Inner	TSF	450
NA	3780	SW	NA3780SW	Inner	TNASW	650
NA	3780		NA3780	Inner	TNA	640
X4S-	3780		X4S-3780	Spacer	2TS-IM	662
	3780		3780	Inner	2TS-IM	662
	3780		3780	Inner	TDO	514
	3780		3780	Inner	TS	204
	3780		3780	Inner	TSF	452
	3781		3781	Inner	TDO	512
	3781		3781	Inner	TS	196
	3782		3782	Inner	TDO	510
	3782		3782	Inner	TS	176
	3782		3782	Inner	TS	178
	3782		3782	Inner	TS	180
	3784		3784	Inner	TDO	514
	3784		3784	Inner	TS	204
Y7S-	3820		Y7S-3820	Spacer	2TS-IM	660
	3820	-B	3820-B	Outer	TSF	442
	3820	-B	3820-B	Outer	TSF	444
	3820		3820	Outer	2TS-IM	660
	3820		3820	Outer	TS	138
	3820		3820	Outer	TS	144
	3820		3820	Outer	TS	152
	3820		3820	Outer	TS	154
	3820		3820	Outer	TS	160
	3820		3820	Outer	TS	166
Y1S-	3821		Y1S-3821	Spacer	2TS-IM	660
	3821		3821	Outer	2TS-IM	660
	3821		3821	Outer	TS	138
	3821		3821	Outer	TS	152
	3821		3821	Outer	TS	166
	3872	A	3872A	Inner	TS	138

TAPERED ROLLER BEARINGS

INDEX

Prefix	Base	Suffix	Part Number Prefix + Base + Suffix	Part Type	Type	Page No.
	3872		3872	Inner	TS	138
X1S-	3875		X1S-3875	Spacer	2TS-IM	660
	3875		3875	Inner	2TS-IM	660
	3875		3875	Inner	TS	152
	3876		3876	Inner	2TS-IM	660
	3876		3876	Inner	TS	152
	3876		3876	Inner	TS	154
	3877	A	3877A	Inner	TS	166
	3877		3877	Inner	TS	166
	3877		3877	Inner	TSF	444
	3878		3878	Inner	TS	144
	3879		3879	Inner	TS	160
	3879		3879	Inner	TSF	442
X1S-	3880		X1S-3880	Spacer	2TS-IM	660
	3880		3880	Inner	2TS-IM	660
	3880		3880	Inner	TS	166
Y1S-	3920		Y1S-3920	Spacer	2TS-IM	664
Y1S-	3920		Y1S-3920	Spacer	2TS-IM	666
Y3S-	3920		Y3S-3920	Spacer	2TS-DM	690
Y4S-	3920		Y4S-3920	Spacer	2TS-DM	688
Y4S-	3920		Y4S-3920	Spacer	2TS-DM	690
	3920	-B	3920-B	Outer	TSF	456
	3920	-B	3920-B	Outer	TSF	458
	3920	-B	3920-B	Outer	TSF	460
	3920	-B	3920-B	Outer	TSF	462
	3920		3920	Outer	2TS-DM	688
	3920		3920	Outer	2TS-DM	690
	3920		3920	Outer	2TS-IM	666
	3920		3920	Outer	TS	226
	3920		3920	Outer	TS	230
	3920		3920	Outer	TS	232
	3920		3920	Outer	TS	234
	3920		3920	Outer	TS	238
	3920		3920	Outer	TS	242
	3920		3920	Outer	TS	248
	3920		3920	Outer	TS	250
	3920		3920	Outer	TS	256
	3921	XA	3921XA	Outer	TS	232
	3925		3925	Outer	2TS-IM	664
	3925		3925	Outer	TS	234
	3925		3925	Outer	TS	242
	3925		3925	Outer	TS	252
	3926		3926	Outer	TS	242
	3926		3926	Outer	TS	252
	3927	AS	3927AS	Outer	TS	240
	3927	X	3927X	Outer	TS	240
	3927	X	3927X	Outer	TS	250
	3975		3975	Inner	2TS-DM	688
	3977	X	3977X	Inner	TS	232
	3977		3977	Inner	2TS-DM	690
	3977		3977	Inner	TS	234
	3977		3977	Inner	TSF	458
	3978		3978	Inner	TS	230
X4S-	3979		X4S-3979	Spacer	2TS-IM	664
	3979		3979	Inner	2TS-DM	690
	3979		3979	Inner	2TS-IM	664

Prefix	Base	Suffix	Part Number Prefix + Base + Suffix	Part Type	Type	Page No.
	3979		3979	Inner	TS	226
	3979		3979	Inner	TSF	456
	3980		3980	Inner	2TS-DM	690
	3980		3980	Inner	TS	234
	3980		3980	Inner	TSF	460
	3981		3981	Inner	TS	230
	3981		3981	Inner	TSF	458
	3982	X	3982X	Inner	TS	240
	3982		3982	Inner	2TS-DM	690
	3982		3982	Inner	TS	240
	3982		3982	Inner	TS	242
	3982		3982	Inner	TSF	462
X1S-	3984		X1S-3984	Spacer	2TS-IM	666
	3984		3984	Inner	2TS-IM	666
	3984		3984	Inner	TS	250
	3984		3984	Inner	TS	252
	3984		3984	Inner	TSF	462
	3992		3992	Inner	TS	250
	3994		3994	Inner	TS	250
	3994		3994	Inner	TS	252
JF	4010		JF4010	Outer	TS	160
T	4020		T4020	Thrust	TTC	736
A	4044		A4044	Inner	TS	88
A	4049		A4049	Inner	TS	88
JF	4049		JF4049	Inner	TS	160
A	4050		A4050	Inner	TS	88
A	4050		A4050	Inner	TSF	424
S-	4055	-C	S-4055-C	Thrust	TTHDFL	728
A	4059		A4059	Inner	2S	712
A	4059		A4059	Inner	TDO	500
A	4059		A4059	Inner	TS	88
A	4059		A4059	Inner	TSF	424
X5SA	4059		X5SA4059	Spacer	2S	712
S-	4077	-C	S-4077-C	Thrust	TTHDFL	728
A	4138	-B	A4138-B	Outer	TSF	424
A	4138	D	A4138D	Outer	TDO	500
A	4138		A4138	Outer	2S	712
A	4138		A4138	Outer	TS	88
Y1S-	4335		Y1S-4335	Spacer	2TS-IM	660
	4335		4335	Outer	2TS-IM	660
	4335		4335	Outer	TS	138
	4335		4335	Outer	TS	154
	4335		4335	Outer	TS	168
	4368		4368	Inner	TS	138
	4375		4375	Inner	TS	154
	4388		4388	Inner	TS	168
X1S-	4395		X1S-4395	Spacer	2TS-IM	660
	4395		4395	Inner	2TS-IM	660
JX	4505	A	JX4505A	Spacer	2S	712
JW	4510		JW4510	Outer	TS	186
	4535		4535	Outer	TS	186
	4535		4535	Outer	TS	208
	4535		4535	Outer	TS	216
	4535		4535	Outer	TS	208
	4536		4536	Outer	TS	216
JW	4549		JW4549	Inner	TS	186

Prefix	Base	Suffix	Part Number Prefix + Base + Suffix	Part Type	Type	Page No.
	4559		4559	Inner	TS	186
	4580		4580	Inner	TS	208
	4595		4595	Inner	TS	216
T	4920	-T4921	T4920-T4921	Thrust	TTHDFL	728
JW	5010		JW5010	Outer	TS	200
JX	5027	A	JX5027A	Spacer	2TS-IM	662
JW	5049		JW5049	Inner	TS	200
	5062		05062	Inner	TS	88
	5062		05062	Inner	TSF	424
	5066		05066	Inner	TDO	500
	5066		05066	Inner	TS	90
	5066		05066	Inner	TSF	424
	5068		05068	Inner	TS	90
A	5069		A5069	Inner	TS	90
	5070	X	05070X	Inner	TS	90
	5070	XS	05070XS	Inner	TS	90
NA	5075		NA05075	Inner	TNA	638
	5075	X	05075X	Inner	TS	92
	5075	X	05075X	Inner	TSF	424
	5075		05075	Inner	TDO	500
	5075		05075	Inner	TS	90
	5075		05075	Inner	TSF	424
NA	5076	SW	NA05076SW	Inner	TNASWE	654
	5079		05079	Inner	TDO	500
	5079		05079	Inner	TS	94
	5079		05079	Inner	TSF	424
A	5144		A5144	Outer	TS	90
	5175		05175	Outer	TS	90
	5185	A	05185A	Outer	TS	94
	5185	-B	05185-B	Outer	TSF	424
	5185	D	05185D	Outer	TDO	500
	5185	D	05185D	Outer	TNA	638
	5185	D	05185D	Outer	TNASWE	654
	5185	-S	05185-S	Outer	TS	90
	5185	-S	05185-S	Outer	TS	92
	5185	-S	05185-S	Outer	TS	94
	5185		05185	Outer	TS	88
	5185		05185	Outer	TS	90
	5185		05185	Outer	TS	94
	5186		05186	Outer	TS	94
JY	5209	R	JY5209R	Spacer	2TS-DM	688
	5335		5335	Outer	TS	180
	5335		5335	Outer	TS	194
	5335		5335	Outer	TS	196
	5356		5356	Inner	TS	180
	5358		5358	Inner	TS	194
	5361		5361	Inner	TS	194
	5395		5395	Inner	TS	196
JXH	5506	A	JXH5506A	Spacer	SR	716
JX	5508	A	JX5508A	Spacer	2TS-IM	664
JY	5508	-S	JY5508-S	Spacer	2TS-DM	688
JW	5510		JW5510	Outer	TS	222
JX	5515	A	JX5515A	Spacer	2TS-IM	664
	5535	-B	5535-B	Outer	TSF	462
	5535		5535	Outer	TS	196
	5535		5535	Outer	TS	210

Prefix	Base	Suffix	Part Number Prefix + Base + Suffix	Part Type	Type	Page No.
	5535		5535	Outer	TS	218
	5535		5535	Outer	TS	222
	5535		5535	Outer	TS	234
	5535		5535	Outer	TS	244
	5535		5535	Outer	TS	248
JW	5549		JW5549	Inner	TS	222
	5562		5562	Inner	TS	196
	5564		5564	Inner	TS	244
	5565		5565	Inner	TS	210
	5566		5566	Inner	TS	222
	5577		5577	Inner	TS	218
	5578		5578	Inner	TS	218
	5582		5582	Inner	TS	234
	5583		5583	Inner	TS	234
	5584		5584	Inner	TS	244
	5595		5595	Inner	TS	248
	5595		5595	Inner	TSF	462
Y2S-	5735		Y2S-5735	Spacer	2TS-DM	692
	5735		5735	Outer	2TS-DM	692
	5735		5735	Outer	TS	272
	5735		5735	Outer	TS	276
	5760		5760	Inner	2TS-DM	692
	5760		5760	Inner	TS	272
	5795		5795	Inner	TS	276
JP	6010	-B	JP6010-B	Outer	TSF	460
JP	6010		JP6010	Outer	TS	232
JW	6010		JW6010	Outer	TS	234
JP	6049		JP6049	Inner	TS	232
JP	6049		JP6049	Inner	TSF	460
JW	6049		JW6049	Inner	TS	234
A	6062		A6062	Inner	TS	88
A	6062		A6062	Inner	TSF	424
A	6067		A6067	Inner	TS	90
A	6067		A6067	Inner	TSF	424
A	6075		A6075	Inner	TS	90
A	6075		A6075	Inner	TSF	424
A	6157	A	A6157A	Outer	TS	90
A	6157	-B	A6157-B	Outer	TSF	424
A	6157		A6157	Outer	TS	88
A	6157		A6157	Outer	TS	90
A	6162		A6162	Outer	TS	90
JYH	6205	R	JYH6205R	Spacer	2TS-IM	660
	6220	-B	6220-B	Outer	TSF	446
	6220	-B	6220-B	Outer	TSF	454
	6220		6220	Outer	TS	184
	6220		6220	Outer	TS	210
	6220		6220	Outer	TS	218
	6220		6220	Outer	TS	218
	6277		6277	Inner	TS	184
	6277		6277	Inner	TSF	446
	6279		6279	Inner	TS	210
	6280		6280	Inner	TS	218
	6280		6280	Inner	TSF	454
Y3S-	6320		Y3S-6320	Spacer	2TS-DM	690
	6320	-B	6320-B	Outer	TSF	456
	6320	-B	6320-B	Outer	TSF	460
	6320	-B	6320-B	Outer	TSF	462

TAPERED ROLLER BEARINGS

INDEX

Prefix	Base	Suffix	Part Number Prefix + Base + Suffix	Part Type	Type	Page No.
	6320		6320	Outer	2TS-DM	690
	6320		6320	Outer	TS	220
	6320		6320	Outer	TS	228
	6320		6320	Outer	TS	236
	6320		6320	Outer	TS	244
	6320		6320	Outer	TS	248
	6320		6320	Outer	TS	254
J	6327		J6327	Outer	TS	248
	6375		6375	Inner	TS	228
	6375		6375	Inner	TSF	456
	6376		6376	Inner	TS	236
	6376		6376	Inner	TSF	460
	6379		6379	Inner	2TS-DM	690
	6379		6379	Inner	TS	248
	6379		6379	Inner	TSF	462
	6380		6380	Inner	TSF	456
	6381		6381	Inner	TS	220
	6381		6381	Inner	TSF	456
	6382		6382	Inner	TS	244
	6386	A	6386A	Inner	TS	254
	6386		6386	Inner	TS	254
	6386		6386	Inner	TSF	462
	6387		6387	Inner	TS	228
	6389		6389	Inner	TS	254
J	6392		J6392	Inner	TS	248
Y4S-	6420		Y4S-6420	Spacer	2TS-IM	664
	6420	A	6420A	Outer	TS	230
	6420	A	6420A	Outer	TS	268
	6420	-B	6420-B	Outer	TSF	456
	6420	-B	6420-B	Outer	TSF	460
	6420	-B	6420-B	Outer	TSF	462
	6420	-B	6420-B	Outer	TSF	464
	6420	-B	6420-B	Outer	TSF	466
	6420	-B	6420-B	Outer	TSF	468
	6420		6420	Outer	2TS-IM	664
	6420		6420	Outer	TS	230
	6420		6420	Outer	TS	246
	6420		6420	Outer	TS	262
	6420		6420	Outer	TS	264
	6420		6420	Outer	TS	268
	6420		6420	Outer	TS	274
	6424		6424	Outer	TS	264
	6454		6454	Inner	TS	262
	6454		6454	Inner	TSF	464
	6455		6455	Inner	TS	230
	6455		6455	Inner	TSF	456
	6459		6459	Inner	TS	264
	6460		6460	Inner	TS	268
	6460		6460	Inner	TSF	466
	6461	A	6461A	Inner	TS	274
	6461		6461	Inner	TS	274
	6461		6461	Inner	TSF	468
X1S-	6464		X1S-6464	Spacer	2TS-IM	664
	6464		6464	Inner	2TS-IM	664
	6464		6464	Inner	TS	246
	6464		6464	Inner	TSF	462

Prefix	Base	Suffix	Part Number Prefix + Base + Suffix	Part Type	Type	Page No.
	6465		6465	Inner	TS	230
	6466		6466	Inner	TS	274
	6475		6475	Inner	TS	246
	6475		6475	Inner	TSF	460
	6484		6484	Inner	TS	262
	6525	X	6525X	Outer	TS	274
	6525	X	6525X	Outer	TS	292
	6525	X	6525X	Outer	TS	294
JX	6526	A	JX6526A	Spacer	2TS-IM	666
Y1S-	6535		Y1S-6535	Spacer	2TS-IM	668
Y2S-	6535		Y2S-6535	Spacer	2TS-DM	694
	6535	-B	6535-B	Outer	TSF	468
	6535	-B	6535-B	Outer	TSF	472
	6535		6535	Outer	2TS-DM	694
	6535		6535	Outer	2TS-IM	668
	6535		6535	Outer	TS	274
	6535		6535	Outer	TS	284
	6535		6535	Outer	TS	292
	6535		6535	Outer	TS	294
	6536		6536	Outer	2TS-DM	694
	6536		6536	Outer	TS	274
	6536		6536	Outer	TS	292
JXH	6558	A	JXH6558A	Spacer	SR	716
	6559	C	6559C	Inner	2TS-DM	694
	6559	C	6559C	Inner	TS	284
X1S-	6575		X1S-6575	Spacer	2TS-IM	668
	6575		6575	Inner	2TS-IM	668
	6575		6575	Inner	TS	274
	6575		6575	Inner	TSF	468
	6576	C	6576C	Inner	TS	274
	6576		6576	Inner	TS	274
	6580		6580	Inner	2TS-DM	694
	6580		6580	Inner	TS	292
	6580		6580	Inner	TSF	472
	6581	X	6581X	Inner	TS	294
	7000	LA	07000LA	Seal	TSL	496
JX	7006	A	JX7006A	Spacer	2TS-IM	668
JF	7010		JF7010	Outer	TS	264
JP	7010	-B	JP7010-B	Outer	TSF	466
JP	7010		JP7010	Outer	TS	262
JW	7010		JW7010	Outer	TS	264
T	7010	V	T7010V	Thrust	TTHDFL	728
JF	7049	A	JF7049A	Inner	TS	264
JF	7049		JF7049	Inner	TS	264
JP	7049		JP7049	Inner	TS	262
JP	7049		JP7049	Inner	TSF	466
JW	7049		JW7049	Inner	TS	264
	7079	X	07079X	Inner	TS	94
	7079		07079	Inner	TDO	500
	7079		07079	Inner	TS	94
	7079		07079	Inner	TSF	426
	7087	X	07087X	Inner	TS	94
	7087	X	07087X	Inner	TS	96
	7087	X	07087X	Inner	TSF	426
	7087		07087	Inner	TS	94
	7087		07087	Inner	TS	96

Prefix	Base	Suffix	Part Number Prefix + Base + Suffix	Part Type	Type	Page No.
	7087		7087	Inner	TSF	426
	7093		7093	Inner	TS	96
	7093		7093	Inner	TS	98
	7093		7093	Inner	TSF	426
	7097		7097	Inner	TDO	500
	7097		7097	Inner	TS	98
	7097		7097	Inner	TS	100
	7098		7098	Inner	TDO	500
	7098		7098	Inner	TS	98
	7098		7098	Inner	TSF	426
	7100	-S	7100-S	Inner	TDO	500
	7100	-S	7100-S	Inner	TS	100
	7100	-SA	7100-SA	Inner	TDO	500
	7100	-SA	7100-SA	Inner	TS	100
	7100	-SA	7100-SA	Inner	TSF	428
	7100		7100	Inner	TSL	496
	7196	-B	7196-B	Outer	TSF	426
	7196	D	7196D	Outer	TDO	500
	7196		7196	Outer	TS	94
	7196		7196	Outer	TS	96
	7196		7196	Outer	TS	98
	7196		7196	Outer	TS	100
	7196		7196	Outer	TSL	496
	7204	-B	7204-B	Outer	TSF	426
	7204		7204	Outer	TS	94
	7204		7204	Outer	TS	96
	7204		7204	Outer	TS	98
	7205		7205	Outer	TS	96
	7205		7205	Outer	TS	98
	7205		7205	Outer	TS	100
	7210	X	7210X	Outer	TS	98
	7210	X	7210X	Outer	TS	100
	7210	XB	7210XB	Outer	TSF	426
	7210	XB	7210XB	Outer	TSF	428
B-	7976	-C	B-7976-C	Thrust	TTVFS	730
JXH	8008	AI	JXH8008AI	Spacer	SR	718
JP	8010	-B	JP8010-B	Outer	TSF	468
JP	8010		JP8010	Outer	TS	278
JW	8010		JW8010	Outer	TS	280
JP	8049		JP8049	Inner	TS	278
JP	8049		JP8049	Inner	TSF	468
JW	8049		JW8049	Inner	TS	280
C-	8091	-C	C-8091-C	Thrust	TTHDFL	728
	8118		8118	Inner	TDO	502
	8118		8118	Inner	TS	114
NA	8125		NA8125	Inner	TNA	638
	8125		8125	Inner	TDO	502
	8125		8125	Inner	TS	118
	8125		8125	Inner	TSF	434
	8231	-B	8231-B	Outer	TSF	434
	8231	D	8231D	Outer	TDO	502
	8231	D	8231D	Outer	TNA	638
	8231		8231	Outer	TS	114
	8231		8231	Outer	TS	118
	8237		8237	Outer	TS	114
B-	8350	-C	B-8350-C	Thrust	TTHDFL	729

Prefix	Base	Suffix	Part Number Prefix + Base + Suffix	Part Type	Type	Page No.
B-	8428	-C	B-8424-C	Thrust	TTVS	730
Y7S-	8520		Y7S-8520	Spacer	2TS-IM	682
	8520	-B	8520-B	Outer	TSF	486
	8520	CD	8520CD	Outer	TDO	562
	8520	CD	8520CD	Outer	TDO	564
	8520		8520	Outer	2TS-IM	682
	8520		8520	Outer	TDI	608
	8520		8520	Outer	TS	350
	8520		8520	Outer	TS	352
	8520		8520	Outer	TS	354
	8573		8573	Inner	TDO	562
	8573		8573	Inner	TS	350
	8573		8573	Inner	TSF	486
	8574		8574	Inner	TDO	564
	8575		8575	Inner	TS	352
	8576	D	8576D	Inner	TDI	608
X1S-	8578		X1S-8578	Spacer	2TS-IM	682
	8578		8578	Inner	2TS-IM	682
	8578		8578	Inner	TDO	564
	8578		8578	Inner	TS	354
	8578		8578	Inner	TSF	486
JX	8599	AI	JX8599AI	Spacer	2TS-IM	670
B-	8824	-C	B-8824-C	Thrust	TTVS	730
JYH	9006	TSR	JYH9006TSR	Spacer	SR	716
JP	9010	-B	JP9010-B	Outer	TSF	472
JP	9010		JP9010	Outer	TS	294
T	9011		T9011	Thrust	TTHDFL	728
JX	9039	A	JX9039A	Spacer	2TS-IM	670
JP	9049		JP9049	Inner	TS	294
JP	9049		JP9049	Inner	TSF	472
	9062		9062	Inner	TS	88
	9067		9067	Inner	TS	92
	9067		9067	Inner	TSF	424
	9074		9074	Inner	TS	92
	9078		9078	Inner	TS	92
	9081		9081	Inner	TSF	426
	9120		9120	Outer	TS	238
	9120		9120	Outer	TS	258
Y1S-	9121		Y1S-9121	Spacer	2TS-DM	690
Y6S-	9121		Y6S-9121	Spacer	2TS-IM	666
	9121		9121	Outer	2TS-DM	690
	9121		9121	Outer	2TS-IM	666
	9121		9121	Outer	TS	238
	9121		9121	Outer	TS	258
	9178		9178	Inner	TS	238
	9180		9180	Inner	TS	238
	9181		9181	Inner	2TS-DM	690
	9181		9181	Inner	TS	238
X1S-	9185		X1S-9185	Spacer	2TS-IM	666
	9185		9185	Inner	2TS-IM	666
	9185		9185	Inner	TS	258
	9194	-S	9194-S	Outer	TS	92
	9194		9194	Outer	TS	88
	9194		9194	Outer	TS	92
	9195	AB	9195AB	Outer	TSF	424
	9195	AB	9195AB	Outer	TSF	426

TAPERED ROLLER BEARINGS

INDEX

Prefix	Base	Suffix	Part Number Prefix + Base + Suffix	Part Type	Type	Page No.
	9195		09195	Outer	TS	88
	9195		09195	Outer	TS	92
	9196		09196	Outer	TS	92
	9201		09201	Outer	TS	92
Y1S-	9220		Y1S-9220	Spacer	2TS-DM	692
Y1S-	9220		Y1S-9220	Spacer	2TS-DM	694
Y3S-	9220		Y3S-9220	Spacer	2TS-IM	668
	9220	D	9220D	Outer	TDO	526
	9220	D	9220D	Outer	TDO	530
	9220		9220	Outer	2TS-DM	692
	9220		9220	Outer	2TS-DM	694
	9220		9220	Outer	2TS-IM	668
	9220		9220	Outer	TS	258
	9220		9220	Outer	TS	274
	9221	-B	9221-B	Outer	TSF	460
	9221	-B	9221-B	Outer	TSF	464
	9221	-B	9221-B	Outer	TSF	468
T	9250	F	T9250F	Thrust	TTHD	727
T	9250	FA	T9250FA	Thrust	TTHD	727
	9275		9275	Inner	TSF	460
	9278		9278	Inner	2TS-DM	692
	9278		9278	Inner	TDO	526
	9278		9278	Inner	TS	258
	9278		9278	Inner	TSF	464
X2S-	9285		X2S-9285	Spacer	2TS-IM	668
	9285		9285	Inner	2TS-DM	694
	9285		9285	Inner	2TS-IM	668
	9285		9285	Inner	TDO	530
	9285		9285	Inner	TS	274
	9285		9285	Inner	TSF	468
	9320	D	9320D	Outer	TDO	526
	9320	D	9320D	Outer	TDO	530
	9320	D	9320D	Outer	TDO	532
	9320	D	9320D	Outer	TDO	534
	9320	D	9320D	Outer	TNA	642
	9320		9320	Outer	TS	276
	9320		9320	Outer	TS	286
Y1S-	9321		Y1S-9321	Spacer	2TS-DM	694
Y6S-	9321		Y6S-9321	Spacer	2TS-IM	668
Y9S-	9321		Y9S-9321	Spacer	2TS-DM	694
	9321		9321	Outer	2TS-DM	694
	9321		9321	Outer	2TS-IM	668
	9321		9321	Outer	TS	262
	9321		9321	Outer	TS	276
	9321		9321	Outer	TS	286
NA	9378		NA9378	Inner	TNA	642
	9378		9378	Inner	TDO	532
	9378		9378	Inner	TS	276
X1H	9380		X1H9380	Spacer	2TS-IM	668
X5S-	9380		X5S-9380	Spacer	2TS-IM	668
	9380		9380	Inner	2TS-DM	694
	9380		9380	Inner	2TS-IM	668
	9380		9380	Inner	TDO	530
	9380		9380	Inner	TS	276
	9382		9382	Inner	TDO	526
	9382		9382	Inner	TS	262

Prefix	Base	Suffix	Part Number Prefix + Base + Suffix	Part Type	Type	Page No.
	9386	H	9386H	Inner	2TS-DM	694
	9386	H	9386H	Inner	TDO	534
	9386	H	9386H	Inner	TS	286
JYH	9508	P	JYH9508P	Spacer	2TS-IM	664
JF	9510		JF9510	Outer	TS	298
JF	9549		JF9549	Inner	TS	298
JP	10010	A	JP10010A	Outer	TS	304
JP	10010	-B	JP10010-B	Outer	TSF	476
JP	10010		JP10010	Outer	TS	298
JP	10010		JP10010	Outer	TS	304
JXH	10010	A	JXH10010A	Spacer	SR	718
JYH	10011	-Q	JYH10011-Q	Spacer	2TS-IM	664
JP	10044		JP10044	Inner	TS	298
JP	10049	A	JP10049A	Inner	TS	304
JP	10049		JP10049	Inner	TS	304
JP	10049		JP10049	Inner	TSF	476
JY	10099	R	JY10099R	Spacer	2TS-DM	688
T	10100	V	T10100V	Thrust	TTHDFL	728
JY	10511	-Q	JY10511-Q	Spacer	2TS-DM	690
JYH	10524	-QH	JYH10524-QH	Spacer	2TS-IM	666
T	11000		T11000	Thrust	TTHDFL	728
JYH	11007	TSR	JYH11007TSR	Spacer	2TS-IM	668
JXH	11010	A	JXH11010A	Spacer	SR	718
JY	11011	-Q	JY11011-Q	Spacer	2TS-DM	690
JYH	11058	RSR	JYH11058RSR	Spacer	SR	716
	11162		11162	Inner	TS	162
	11162		11162	Inner	TS	164
	11162		11162	Inner	TSF	444
	11163		11163	Inner	TS	162
	11165	X	11165X	Inner	TS	170
	11300	-B	11300-B	Outer	TSF	444
	11300		11300	Outer	TS	162
	11315		11315	Outer	TS	164
	11315		11315	Outer	TS	170
	11520		11520	Outer	TS	88
	11590		11590	Inner	TS	88
LM	11710		LM11710	Outer	2S	712
LM	11710		LM11710	Outer	TS	90
LM	11749		LM11749	Inner	2S	712
LM	11749		LM11749	Inner	TS	90
LM	11900	EA	LM11900EA	Seal	TSL	496
LM	11900	LA	LM11900LA	Seal	TSL	496
LM	11910		LM11910	Outer	2S	712
LM	11910		LM11910	Outer	TS	90
LM	11910		LM11910	Outer	TSL	496
LM	11919		LM11919	Outer	TS	92
LM	11949		LM11949	Inner	2S	712
LM	11949		LM11949	Inner	TS	90
LM	11949		LM11949	Inner	TS	92
LM	11949		LM11949	Inner	TSL	496
JP	12010		JP12010	Outer	2TS-IM	674
JP	12010		JP12010	Outer	TS	316
JY	12021	-Q	JY12021-Q	Spacer	2TS-DM	688
JX	12030	AM	JX12030AM	Spacer	2TS-IM	674
JP	12049	A	JP12049A	Inner	TS	316
JP	12049		JP12049	Inner	2TS-IM	674

Prefix	Base	Suffix	Part Number Prefix + Base + Suffix	Part Type	Type	Page No.
JP	12049		JP12049	Inner	TS	316
	12168		12168	Inner	TS	170
	12175		12175	Inner	TS	172
	12175		12175	Inner	TSF	448
	12303	-B	12303-B	Outer	TSF	448
	12303		12303	Outer	TS	170
	12303		12303	Outer	TS	172
JYH	12508	TSR	JYH12508TSR	Spacer	SR	718
	12520		12520	Outer	TS	94
	12580		12580	Inner	TS	94
M	12600	LA	M12600LA	Seal	TSL	496
M	12610		M12610	Outer	TS	94
M	12610		M12610	Outer	TSL	496
M	12648	A	M12648A	Inner	TS	94
M	12648		M12648	Inner	TS	94
M	12649		M12649	Inner	TS	94
M	12649		M12649	Inner	TSL	496
LM	12710		LM12710	Outer	TS	94
LM	12711		LM12711	Outer	2TS-IM	660
LM	12711		LM12711	Outer	TS	94
LM	12749		LM12749	Inner	2TS-IM	660
LM	12749		LM12749	Inner	TS	94
JP	13010	-B	JP13010-B	Outer	TSF	480
JP	13010		JP13010	Outer	2TS-IM	676
JP	13010		JP13010	Outer	TS	320
JP	13010		JP13010	Outer	TS	322
JY	13013	-Q	JY13013-Q	Spacer	2TS-DM	694
JP	13049	A	JP13049A	Inner	TS	320
JP	13049		JP13049	Inner	2TS-IM	676
JP	13049		JP13049	Inner	TS	322
JP	13049		JP13049	Inner	TSF	480
	13169	D	13169D	Inner	TDI	600
	13175		13175	Inner	TS	174
	13176	D	13176D	Inner	TDI	600
	13181		13181	Inner	TS	190
	13182	D	13182D	Inner	TDI	600
	13318		13318	Outer	TDI	600
	13318		13318	Outer	TS	174
	13318		13318	Outer	TS	190
	13600	LA	13600LA	Seal	TSL	496
	13620		13620	Outer	TS	146
	13620		13620	Outer	TS	148
	13621	A	13621A	Outer	TSL	496
	13621	D	13621D	Outer	TDO	506
	13621	D	13621D	Outer	TNA	638
	13621		13621	Outer	TS	142
	13621		13621	Outer	TS	146
	13621		13621	Outer	TS	148
	13621		13621	Outer	TSL	496
	13624		13624	Outer	TS	148
	13682		13682	Inner	TS	142
	13685	A	13685A	Inner	TS	146
	13685	A	13685A	Inner	TS	148
	13685		13685	Inner	TDO	506
	13685		13685	Inner	TS	146
	13685		13685	Inner	TS	148

Prefix	Base	Suffix	Part Number Prefix + Base + Suffix	Part Type	Type	Page No.
	13685		13685	Inner	TSL	496
	13686		13686	Inner	TS	148
NA	13687		NA13687	Inner	TNA	638
	13687		13687	Inner	TDO	506
	13687		13687	Inner	TS	146
	13687		13687	Inner	TS	148
	13830		13830	Outer	TS	146
	13830		13830	Outer	TS	156
	13835	D	13835D	Outer	TDO	506
	13835	D	13835D	Outer	TDO	508
	13836	-B	13836-B	Outer	TSF	442
	13836		13836	Outer	TS	146
	13836		13836	Outer	TS	156
	13836		13836	Outer	TS	156
	13889		13889	Inner	TDO	506
	13889		13889	Inner	TS	146
	13889		13889	Inner	TSF	442
	13890		13890	Inner	TDO	508
	13890		13890	Inner	TS	156
	13890		13890	Inner	TSF	442
JP	14010	-B	JP14010-B	Outer	TSF	480
JP	14010		JP14010	Outer	TS	326
JY	14016	-Q	JY14016-Q	Spacer	2TS-DM	694
JP	14049		JP14049	Inner	TS	326
JP	14049		JP14049	Inner	TSF	480
JYH	14099	R	JYH14099R	Spacer	2TS-IM	668
	14116		14116	Inner	TS	118
	14117	A	14117A	Inner	TDO	502
	14117	A	14117A	Inner	TS	112
	14117	A	14117A	Inner	TS	114
	14117	A	14117A	Inner	TSF	430
	14118	A	14118A	Inner	TS	112
	14118	AS	14118AS	Inner	TS	112
	14118		14118	Inner	TDO	502
	14118		14118	Inner	TS	112
	14118		14118	Inner	TS	114
	14118		14118	Inner	TSF	430
	14124		14124	Inner	TS	122
	14125	A	14125A	Inner	TDO	504
	14125	A	14125A	Inner	TS	122
	14125	A	14125A	Inner	TSF	432
	14126	D	14126D	Inner	TDI	600
	14130		14130	Inner	TS	126
	14130		14130	Inner	TS	128
	14130		14130	Inner	TSF	434
	14131		14131	Inner	TDO	504
	14131		14131	Inner	TS	126
	14131		14131	Inner	TSF	434
	14137	A	14137A	Inner	TDO	504
	14137	A	14137A	Inner	TS	132
	14137	A	14137A	Inner	TSF	436
NA	14138		NA14138	Inner	TNA	638
	14138	A	14138A	Inner	TDO	504
	14138	A	14138A	Inner	TS	132
	14138	A	14138A	Inner	TSF	436
	14139	X	14139X	Inner	TS	140
	14139		14139	Inner	TDO	506

TAPERED ROLLER BEARINGS

INDEX

Prefix	Base	Suffix	Part Number Prefix + Base + Suffix	Part Type	Type	Page No.
	14139		14139	Inner	TS	138
	14139		14139	Inner	TSF	438
	14274	A	14274A	Outer	TS	112
	14274	-S	14274-S	Outer	TS	140
	14274		14274	Outer	TS	112
	14274		14274	Outer	TS	122
	14274		14274	Outer	TS	126
	14274		14274	Outer	TS	132
	14274		14274	Outer	TS	138
	14275	A	14275A	Outer	TS	132
	14276	-B	14276-B	Outer	TSF	430
	14276	-B	14276-B	Outer	TSF	432
	14276	-B	14276-B	Outer	TSF	434
	14276	-B	14276-B	Outer	TSF	436
	14276	-B	14276-B	Outer	TSF	438
	14276	D	14276D	Outer	TDO	502
	14276	D	14276D	Outer	TDO	504
	14276	D	14276D	Outer	TDO	506
	14276	D	14276D	Outer	TNA	638
	14276		14276	Outer	TDI	600
	14276		14276	Outer	TS	112
	14276		14276	Outer	TS	118
	14276		14276	Outer	TS	122
	14276		14276	Outer	TS	126
	14276		14276	Outer	TS	132
	14276		14276	Outer	TS	138
	14277		14277	Outer	TS	122
	14277		14277	Outer	TS	132
	14282		14282	Outer	TS	122
	14282		14282	Outer	TS	128
	14282		14282	Outer	TS	138
	14283		14283	Outer	TS	114
	14283		14283	Outer	TS	138
JY	14516	-S	JY14516-S	Spacer	2TS-DM	694
	14525		14525	Outer	TS	132
	14585		14585	Inner	TS	132
XC	14638	-SC	XC14638-SC	Spacer	2TS-IM	668
	15100	-S	15100-S	Inner	TDO	500
	15100	-S	15100-S	Inner	TS	104
	15100	-SR	15100-SR	Inner	TS	102
	15100		15100	Inner	TS	102
	15101		15101	Inner	TDO	500
	15101		15101	Inner	TS	102
	15102		15102	Inner	TS	102
	15103	-S	15103-S	Inner	TS	104
	15103		15103	Inner	TS	104
	15106		15106	Inner	TS	106
	15112		15112	Inner	TDO	502
	15112		15112	Inner	TS	108
	15113		15113	Inner	TS	108
	15115		15115	Inner	TS	112
	15116		15116	Inner	TS	114
NA	15117	SW	NA15117SW	Inner	TNASWE	654
	15117		15117	Inner	TDO	502
	15117		15117	Inner	TS	112
NA	15118	SW	NA15118SW	Inner	TNASWE	654

Prefix	Base	Suffix	Part Number Prefix + Base + Suffix	Part Type	Type	Page No.
	15118		15118	Inner	TS	116
	15118		15118	Inner	TSF	432
	15119		15119	Inner	TDO	502
	15119		15119	Inner	TS	116
	15120	A	15120A	Inner	TS	116
	15120		15120	Inner	TS	116
	15123		15123	Inner	TDO	502
	15123		15123	Inner	TS	118
	15123		15123	Inner	TS	120
	15123		15123	Inner	TSF	432
X1S-	15125		X1S-15125	Spacer	2S	712
	15125		15125	Inner	2S	712
	15125		15125	Inner	TDO	502
	15125		15125	Inner	TS	118
	15125		15125	Inner	TS	120
	15125		15125	Inner	TSF	432
	15126		15126	Inner	TDO	504
	15126		15126	Inner	TS	118
	15126		15126	Inner	TS	120
	15243		15243	Outer	TS	104
	15244	X	15244X	Outer	TS	112
	15244		15244	Outer	TS	102
	15244		15244	Outer	TS	108
	15244		15244	Outer	TS	112
	15244		15244	Outer	TS	116
	15244		15244	Outer	TS	120
	15245		15245	Outer	2S	712
	15245		15245	Outer	TS	102
	15245		15245	Outer	TS	104
	15245		15245	Outer	TS	106
	15245		15245	Outer	TS	108
	15245		15245	Outer	TS	112
	15245		15245	Outer	TS	114
	15245		15245	Outer	TS	116
	15245		15245	Outer	TS	118
	15249		15249	Outer	TS	116
	15250	-B	15250-B	Outer	TSF	432
	15250	X	15250X	Outer	TS	102
	15250	X	15250X	Outer	TS	104
	15250	X	15250X	Outer	TS	106
	15250	X	15250X	Outer	TS	108
	15250	X	15250X	Outer	TS	116
	15250	X	15250X	Outer	TS	120
	15250		15250	Outer	TS	102
	15250		15250	Outer	TS	108
	15250		15250	Outer	TS	112
	15250		15250	Outer	TS	114
	15250		15250	Outer	TS	116
	15250		15250	Outer	TS	120
	15251	D	15251D	Outer	TDO	500
	15251	D	15251D	Outer	TDO	502
	15251	D	15251D	Outer	TDO	504
	15251	D	15251D	Outer	TNASWE	654
T	15500		T15500	Thrust	TTHDFL	729
T	15501		T15501	Thrust	TTHDFL	729
JY	15516	-Q	JY15516-Q	Spacer	2TS-DM	696

Prefix	Base	Suffix	Part Number Prefix + Base + Suffix	Part Type	Type	Page No.
	15520	-B	15520-B	Outer	TSF	428
	15520	-B	15520-B	Outer	TSF	430
	15520		15520	Outer	2S	712
	15520		15520	Outer	TS	100
	15520		15520	Outer	TS	104
	15520		15520	Outer	TS	106
	15520		15520	Outer	TS	108
	15523		15523	Outer	TS	102
	15523		15523	Outer	TS	106
JYH	15539	RSR	JYH15539RSR	Spacer	2TS-IM	670
X1S-	15578		X1S-15578	Spacer	2S	712
	15578		15578	Inner	2S	712
	15578		15578	Inner	TS	100
	15578		15578	Inner	TS	102
	15578		15578	Inner	TSF	428
	15579	X	15579X	Inner	TS	104
	15580		15580	Inner	TS	106
J	15585		J15585	Inner	TS	106
	15590		15590	Inner	TS	108
	15590		15590	Inner	TSF	430
JY	16018	R	JY16018R	Spacer	2TS-DM	696
T	16021		T16021	Thrust	TTHD	727
	16131		16131	Inner	TS	128
	16131		16131	Inner	TSF	434
	16137		16137	Inner	TS	132
	16137		16137	Inner	TSF	436
	16143		16143	Inner	TS	144
	16143		16143	Inner	TSF	438
	16150		16150	Inner	TS	148
	16150		16150	Inner	TSF	440
J	16154		J16154	Inner	TS	156
	16282		16282	Outer	TS	144
	16282		16282	Outer	TS	148
	16283		16283	Outer	TS	148
	16284	-B	16284-B	Outer	TSF	434
	16284	-B	16284-B	Outer	TSF	436
	16284	-B	16284-B	Outer	TSF	438
	16284	-B	16284-B	Outer	TSF	440
	16284		16284	Outer	TS	128
	16284		16284	Outer	TS	132
	16284		16284	Outer	TS	144
	16284		16284	Outer	TS	148
J	16285		J16285	Outer	TS	156
	16522		16522	Outer	TS	120
	16522		16522	Outer	TS	126
	16579		16579	Inner	TS	120
	16582		16582	Inner	TS	126
	16929		16929	Outer	TS	172
	16986		16986	Inner	TS	172
JYH	17006	R	JYH17006R	Spacer	2TS-IM	674
NA	17098		NA17098	Inner	TNA	638
	17098	X	17098X	Inner	TDO	500
	17098		17098	Inner	TDO	500
	17098		17098	Inner	TS	98
	17118	-S	17118-S	Inner	TS	112
	17118		17118	Inner	TDO	502

Prefix	Base	Suffix	Part Number Prefix + Base + Suffix	Part Type	Type	Page No.
	17118		17118	Inner	TS	110
	17118		17118	Inner	TS	112
	17118		17118	Inner	TSF	430
	17119		17119	Inner	TDO	502
	17119		17119	Inner	TS	114
	17119		17119	Inner	TSF	432
	17244	A	17244A	Outer	TS	98
	17244	A	17244A	Outer	TS	110
	17244	-B	17244-B	Outer	TSF	430
	17244	-B	17244-B	Outer	TSF	432
	17244		17244	Outer	TS	98
	17244		17244	Outer	TS	112
	17244		17244	Outer	TS	114
	17245	D	17245D	Outer	TDO	500
	17245	D	17245D	Outer	TDO	502
	17245	D	17245D	Outer	TNA	638
	17520	-B	17520-B	Outer	TSF	424
	17520		17520	Outer	TS	88
	17580		17580	Inner	TS	88
	17580		17580	Inner	TSF	424
	17830		17830	Outer	TS	172
	17831		17831	Outer	TS	172
	17831		17831	Outer	TS	186
	17886		17886	Inner	TS	172
	17887		17887	Inner	TS	186
JY	18016	-Q	JY18016-Q	Spacer	2TS-DM	696
	18200		18200	Inner	TS	202
	18200		18200	Inner	TSF	454
	18204	X	18204X	Inner	TS	212
	18204	X	18204X	Inner	TSF	454
	18335	X	18335X	Outer	TS	212
	18337	-B	18337-B	Outer	TSF	454
	18337		18337	Outer	TS	202
	18520		18520	Outer	TS	156
	18520		18520	Outer	TS	162
	18587		18587	Inner	TS	156
	18590		18590	Inner	TS	162
	18620	-B	18620-B	Outer	TSF	448
	18620	-B	18620-B	Outer	TSF	450
	18620	D	18620D	Outer	TDO	508
	18620	D	18620D	Outer	TDO	512
	18620	D	18620D	Outer	TNA	638
	18620		18620	Outer	TS	172
	18620		18620	Outer	TS	190
NA	18685		NA18685	Inner	TNA	638
	18685		18685	Inner	TDO	508
	18685		18685	Inner	TS	172
	18685		18685	Inner	TSF	448
	18690		18690	Inner	TDO	512
	18690		18690	Inner	TS	190
	18690		18690	Inner	TSF	450
Y5S-	18720		Y5S-18720	Spacer	2TS-IM	662
	18720	-B	18720-B	Outer	TSF	454
	18720		18720	Outer	2TS-IM	662
	18720		18720	Outer	TS	200
	18721		18721	Outer	TS	200

TAPERED ROLLER BEARINGS

INDEX

Prefix	Base	Suffix	Part Number Prefix + Base + Suffix	Part Type	Type	Page No.
	18723		18723	Outer	TS	202
	18724		18724	Outer	TS	202
X4S-	18790		X4S-18790	Spacer	2TS-IM	662
X7S-	18790		X7S-18790	Spacer	2TS-IM	662
	18790		18790	Inner	2TS-IM	662
	18790		18790	Inner	TS	200
	18790		18790	Inner	TS	202
	18790		18790	Inner	TSF	454
	19138	X	19138X	Inner	TS	140
	19138	X	19138X	Inner	TSF	438
	19138		19138	Inner	TS	138
	19138		19138	Inner	TSF	438
	19143		19143	Inner	TS	142
	19143		19143	Inner	TS	144
	19143		19143	Inner	TSF	438
	19146	TD	19146TD	Inner	TDIT	630
	19149	X	19149X	Inner	TS	146
	19150		19150	Inner	TS	146
	19150		19150	Inner	TS	148
	19150		19150	Inner	TSF	442
	19267	X	19267X	Outer	TS	138
	19267	X	19267X	Outer	TS	146
	19268	-B	19268-B	Outer	TSF	438
	19268	-B	19268-B	Outer	TSF	442
	19268		19268	Outer	TS	138
	19268		19268	Outer	TS	142
	19268		19268	Outer	TS	146
	19269		19269	Outer	TS	146
	19281		19281	Outer	TS	148
	19283	-B	19283-B	Outer	TSF	438
	19283	-B	19283-B	Outer	TSF	442
	19283	X	19283X	Outer	TS	140
	19283	X	19283X	Outer	TS	144
	19283		19283	Outer	TDIT	630
	19283		19283	Outer	TS	138
	19283		19283	Outer	TS	140
	19283		19283	Outer	TS	144
	19283		19283	Outer	TS	148
JY	20020	-Q	JY20020-Q	Spacer	2TS-DM	698
T	20751		A-6096-C	Thrust	TTHDFL	729
T	20751		T20751	Thrust	TTHDFL	729
	21063		21063	Inner	TS	88
	21075	A	21075A	Inner	TS	92
	21075		21075	Inner	TDO	500
	21075		21075	Inner	TS	92
	21075		21075	Inner	TSF	424
	21212	-B	21212-B	Outer	TSF	424
	21212		21212	Outer	TS	88
	21212		21212	Outer	TS	92
	21213		21213	Outer	TS	92
	21226	D	21226D	Outer	TDO	500
L	21511		L21511	Outer	TS	88
JY	21523	RM	JY21523RM	Spacer	2TS-IM	674
L	21549		L21549	Inner	TS	88
X2S-	22168		X2S-22168	Spacer	2TS-IM	662
	22168		22168	Inner	TDO	508

Prefix	Base	Suffix	Part Number Prefix + Base + Suffix	Part Type	Type	Page No.
	22168		22168	Inner	TS	170
NA	22171		NA22171	Inner	TNA	638
	22325	D	22325D	Outer	TDO	508
	22325	D	22325D	Outer	TNA	638
	22325		22325	Outer	TS	170
	22720		22720	Outer	TS	170
	22721		22721	Outer	TS	164
	22778		22778	Inner	TS	164
	22780		22780	Inner	TS	170
JY	23028	-Q	JY23028-Q	Spacer	2TS-DM	700
	23092		23092	Inner	TS	98
	23100		23100	Inner	TS	104
	23100		23100	Inner	TSF	428
	23101	X	23101X	Inner	TS	102
	23250	X	23250X	Outer	TS	102
	23256	-B	23256-B	Outer	TSF	428
	23256		23256	Outer	TS	98
	23256		23256	Outer	TS	104
	23420		23420	Outer	TS	120
	23491		23491	Inner	TS	120
	23620		23620	Outer	TS	124
	23620		23620	Outer	TS	134
	23620		23620	Outer	TS	140
	23621		23621	Outer	2S	712
	23621		23621	Outer	TS	140
	23685		23685	Inner	TS	124
	23690		23690	Inner	TS	134
	23691		23691	Inner	2S	712
	23691		23691	Inner	TS	140
JP	24010		JP24010	Outer	TS	354
JP	24049		JP24049	Inner	TS	354
JY	24050	-Q	JY24050-Q	Spacer	2TS-DM	698
	24112		24112	Inner	TS	108
	24118		24118	Inner	TDO	502
	24118		24118	Inner	TS	114
	24261		24261	Outer	TS	108
	24261		24261	Outer	TS	114
	24262	D	24262D	Outer	TDO	502
	24720	D	24720D	Outer	TNASWE	654
	24720		24720	Outer	TS	162
	24720		24720	Outer	TS	164
	24721		24721	Outer	TS	164
	24722		24722	Outer	TS	162
NA	24776	SW	NA24776SW	Inner	TNASWE	654
	24780		24780	Inner	TS	162
	24780		24780	Inner	TS	164
	24781		24781	Inner	TS	164
JY	25020	-S	JY25020-S	Spacer	2TS-DM	704
	25518		25518	Outer	TS	172
	25518		25518	Outer	TS	184
	25519		25519	Outer	TS	172
	25519		25519	Outer	TS	174
Y4S-	25520		Y4S-25520	Spacer	2TS-DM	688
	25520	D	25520D	Outer	TDO	506
	25520	D	25520D	Outer	TDO	508
	25520	D	25520D	Outer	TDO	510

Prefix	Base	Suffix	Part Number Prefix + Base + Suffix	Part Type	Type	Page No.
	25520		25520	Outer	2TS-DM	688
	25520		25520	Outer	TS	144
	25520		25520	Outer	TS	152
	25520		25520	Outer	TS	170
	25520		25520	Outer	TS	172
	25520		25520	Outer	TS	174
	25520		25520	Outer	TS	184
	25520		25520	Outer	TS	188
	25520		25520	Outer	TS	190
	25521	-B	25521-B	Outer	TSF	446
	25521	-B	25521-B	Outer	TSF	448
	25521		25521	Outer	TS	170
	25521		25521	Outer	TS	174
	25521		25521	Outer	TS	184
	25521		25521	Outer	TS	188
	25522		25522	Outer	TS	170
	25522		25522	Outer	TS	172
	25522		25522	Outer	TS	174
	25522		25522	Outer	TS	188
	25523		25523	Outer	TS	170
	25523		25523	Outer	TS	172
	25523		25523	Outer	TS	174
	25523		25523	Outer	TS	184
	25523		25523	Outer	TS	188
	25524		25524	Outer	TS	174
	25526		25526	Outer	TS	152
	25526		25526	Outer	TS	176
	25526		25526	Outer	TS	184
	25527		25527	Outer	TS	188
	25528		25528	Outer	TS	188
	25570		25570	Inner	TDO	506
	25570		25570	Inner	TS	144
X1S-	25572		X1S-25572	Spacer	2TS-IM	660
	25572		25572	Inner	TDO	506
	25572		25572	Inner	TS	152
	25576		25576	Inner	TS	170
	25576		25576	Inner	TSF	446
	25577		25577	Inner	TS	172
	25578		25578	Inner	TDO	508
	25578		25578	Inner	TS	170
	25580		25580	Inner	2TS-DM	688
	25580		25580	Inner	TDO	508
	25580		25580	Inner	TS	174
	25580		25580	Inner	TS	176
	25580		25580	Inner	TSF	448
	25581		25581	Inner	TDO	508
	25581		25581	Inner	TS	174
	25582		25582	Inner	TS	174
	25583		25583	Inner	TS	174
	25584	A	25584A	Inner	TS	184
	25584		25584	Inner	TDO	510
	25584		25584	Inner	TS	184
	25584		25584	Inner	TSF	448
	25590		25590	Inner	TDO	510
	25590		25590	Inner	TS	188
	25590		25590	Inner	TSF	448

Prefix	Base	Suffix	Part Number Prefix + Base + Suffix	Part Type	Type	Page No.
	25592		25592	Inner	TS	190
NP	25753		NP025753	Inner	TDI	624
	25820		25820	Outer	TS	134
	25820		25820	Outer	TS	142
	25821		25821	Outer	TS	134
	25821		25821	Outer	TS	142
	25877	A	25877A	Inner	TS	134
	25877		25877	Inner	TS	134
	25878		25878	Inner	TS	134
	25880		25880	Inner	TS	142
	26093		26093	Inner	TSF	426
	26100		26100	Inner	TDO	500
	26100		26100	Inner	TS	104
	26100		26100	Inner	TSF	426
	26112		26112	Inner	TS	110
	26112		26112	Inner	TSF	428
NA	26118	SW	NA26118SW	Inner	TNASW	650
NA	26118		NA26118	Inner	TNA	638
	26118	-S	26118-S	Inner	TS	114
	26118	-S	26118-S	Inner	TSF	430
	26118		26118	Inner	TDO	502
	26118		26118	Inner	TS	112
	26118		26118	Inner	TSF	430
	26126	X	26126X	Inner	TS	124
	26126		26126	Inner	TS	124
	26126		26126	Inner	TSF	434
	26131		26131	Inner	TDO	504
	26131		26131	Inner	TS	128
	26131		26131	Inner	TSF	434
	26132		26132	Inner	TS	126
	26132		26132	Inner	TSF	434
	26274		26274	Outer	TS	104
	26274		26274	Outer	TS	110
	26274		26274	Outer	TS	126
	26282	D	26282D	Outer	TDO	500
	26282	D	26282D	Outer	TDO	502
	26282	D	26282D	Outer	TDO	504
	26283	-B	26283-B	Outer	TSF	426
	26283	-B	26283-B	Outer	TSF	428
	26283	-B	26283-B	Outer	TSF	430
	26283	-B	26283-B	Outer	TSF	434
	26283	-S	26283-S	Outer	TS	114
	26283	-S	26283-S	Outer	TS	128
	26283		26283	Outer	TS	110
	26283		26283	Outer	TS	112
	26283		26283	Outer	TS	124
	26283		26283	Outer	TS	128
	26284	D	26284D	Outer	TDO	502
	26284	D	26284D	Outer	TDO	504
	26284	D	26284D	Outer	TNA	638
	26284	D	26284D	Outer	TNASW	650
	26300		26300	Outer	TS	110
	26300		26300	Outer	TS	112
Y1S-	26820		Y1S-26820	Spacer	2TS-DM	688
Y3S-	26820		Y3S-26820	Spacer	2TS-IM	662
	26820		26820	Outer	2TS-DM	688

TAPERED ROLLER BEARINGS

INDEX

Prefix	Base	Suffix	Part Number Prefix + Base + Suffix	Part Type	Type	Page No.
	26820		26820	Outer	2TS-IM	662
	26820		26820	Outer	TS	142
	26820		26820	Outer	TS	144
	26820		26820	Outer	TS	152
	26820		26820	Outer	TS	158
	26820		26820	Outer	TS	164
	26820		26820	Outer	TS	172
	26821		26821	Outer	TS	158
	26821		26821	Outer	TS	164
	26822	A	26822A	Outer	TS	156
	26822	-B	26822-B	Outer	TSF	444
	26822		26822	Outer	TS	140
	26822		26822	Outer	TS	150
	26822		26822	Outer	TS	156
	26822		26822	Outer	TS	164
	26822		26822	Outer	TS	170
	26823		26823	Outer	TS	150
	26823		26823	Outer	TS	156
	26823		26823	Outer	TS	170
	26824		26824	Outer	TS	140
	26824		26824	Outer	TS	144
	26824		26824	Outer	TS	150
	26824		26824	Outer	TS	156
	26824		26824	Outer	TS	172
	26830		26830	Outer	TS	152
	26830		26830	Outer	TS	158
	26830		26830	Outer	TS	172
	26877		26877	Inner	TS	144
	26878		26878	Inner	TS	150
	26878		26878	Inner	TS	152
	26880		26880	Inner	TS	156
	26880		26880	Inner	TS	158
	26881		26881	Inner	TS	156
	26881		26881	Inner	TS	158
	26882		26882	Inner	TS	164
	26882		26882	Inner	TSF	444
	26883		26883	Inner	TS	140
	26883		26883	Inner	TS	142
	26884		26884	Inner	TS	170
	26884		26884	Inner	TS	172
	26885		26885	Inner	2TS-DM	688
	26885		26885	Inner	TS	164
	26886		26886	Inner	2TS-IM	662
	26886		26886	Inner	TS	172
Y2S-	27620		Y2S-27620	Spacer	2TS-DM	694
Y5S-	27620		Y5S-27620	Spacer	2TS-IM	668
	27620	-B	27620-B	Outer	TSF	468
	27620	-B	27620-B	Outer	TSF	470
	27620		27620	Outer	2TS-DM	694
	27620		27620	Outer	2TS-IM	668
	27620		27620	Outer	2S	714
	27620		27620	Outer	TS	266
	27620		27620	Outer	TS	270
	27620		27620	Outer	TS	280
	27620		27620	Outer	TS	286
	27620		27620	Outer	TS	286
	27680		27680	Inner	TS	266

Prefix	Base	Suffix	Part Number Prefix + Base + Suffix	Part Type	Type	Page No.
	27684	A	27684A	Inner	TS	270
	27684		27684	Inner	TS	270
	27684		27684	Inner	TSF	468
	27687		27687	Inner	TS	280
	27687		27687	Inner	TSF	470
X3S-	27689		X3S-27689	Spacer	2TS-IM	668
	27689		27689	Inner	2TS-IM	668
	27689		27689	Inner	TS	286
	27690		27690	Inner	2TS-DM	694
	27690		27690	Inner	2S	714
	27690		27690	Inner	TS	286
	27690		27690	Inner	TSF	470
	27691		27691	Inner	TS	286
	27695		27695	Inner	TS	286
	27820	D	27820D	Outer	TDO	506
	27820		27820	Outer	TS	136
	27820		27820	Outer	TS	150
	27820		27820	Outer	TS	152
	27875		27875	Inner	TDO	506
	27875		27875	Inner	TS	136
	27880		27880	Inner	TDO	506
	27880		27880	Inner	TS	150
	27881		27881	Inner	TDO	506
	27881		27881	Inner	TS	152
JY	28056	-Q	JY28056-Q	Spacer	2TS-DM	700
	28118		28118	Inner	TS	116
	28118		28118	Inner	TSF	430
	28137		28137	Inner	TDO	504
	28137		28137	Inner	TS	136
	28137		28137	Inner	TSF	436
NA	28138		NA28138	Inner	TNA	638
	28138		28138	Inner	TS	138
	28138		28138	Inner	TS	140
	28138		28138	Inner	TSF	436
X1S-	28150		X1S-28150	Spacer	2TS-IM	660
	28150		28150	Inner	TDO	506
	28150		28150	Inner	TS	148
	28150		28150	Inner	TS	150
	28150		28150	Inner	TSF	440
	28151		28151	Inner	TS	148
	28151		28151	Inner	TSF	440
	28156		28156	Inner	TS	158
	28156		28156	Inner	TS	160
	28158		28158	Inner	TDO	508
	28158		28158	Inner	TS	160
	28158		28158	Inner	TSF	444
	28159		28159	Inner	TDO	508
	28159		28159	Inner	TS	158
	28300	X	28300X	Outer	TS	138
	28300	X	28300X	Outer	TS	148
	28300	X	28300X	Outer	TS	160
	28300		28300	Outer	TS	116
	28300		28300	Outer	TS	148
	28300		28300	Outer	TS	150
	28300		28300	Outer	TS	158
	28315	A	28315A	Outer	TS	150

Prefix	Base	Suffix	Part Number Prefix + Base + Suffix	Part Type	Type	Page No.
	28315	A	28315A	Outer	TS	160
	28315	-B	28315-B	Outer	TSF	430
	28315	-B	28315-B	Outer	TSF	436
	28315	-B	28315-B	Outer	TSF	440
	28315	-B	28315-B	Outer	TSF	444
	28315		28315	Outer	TS	116
	28315		28315	Outer	TS	140
	28315		28315	Outer	TS	160
	28317		28317	Outer	TS	136
	28317		28317	Outer	TS	160
	28318	D	28318D	Outer	TDO	504
	28318	D	28318D	Outer	TDO	506
	28318	D	28318D	Outer	TDO	508
	28318	D	28318D	Outer	TNA	638
	28520		28520	Outer	TS	186
	28520		28520	Outer	TS	198
	28520		28520	Outer	TS	202
	28520		28520	Outer	TS	212
	28521	-B	28521-B	Outer	TSF	452
	28521	-B	28521-B	Outer	TSF	454
	28521		28521	Outer	2S	714
	28521		28521	Outer	TS	198
	28521		28521	Outer	TS	202
	28521		28521	Outer	TS	212
	28523		28523	Outer	2TS-IM	662
	28523		28523	Outer	TS	202
J	28577		J28577	Inner	TS	186
	28579		28579	Inner	TS	198
X1S-	28580		X1S-28580	Spacer	2TS-IM	662
	28580		28580	Inner	2TS-IM	662
	28580		28580	Inner	TS	202
	28580		28580	Inner	TSF	452
	28584		28584	Inner	2S	714
	28584		28584	Inner	TS	212
	28584		28584	Inner	TSF	454
	28621		28621	Outer	TS	224
Y4S-	28622		Y4S-28622	Spacer	2TS-DM	688
	28622	-B	28622-B	Outer	TSF	458
	28622		28622	Outer	2TS-DM	688
	28622		28622	Outer	TS	222
	28622		28622	Outer	TS	224
	28623		28623	Outer	TS	224
	28680		28680	Inner	2TS-DM	688
	28680		28680	Inner	TS	222
	28682		28682	Inner	TS	224
	28682		28682	Inner	TSF	458
	28820		28820	Outer	TS	356
	28880		28880	Inner	TS	356
	28919		28919	Outer	TS	238
	28920		28920	Outer	TS	234
	28920		28920	Outer	TS	238
Y1S-	28921		Y1S-28921	Spacer	2TS-DM	690
	28921	A	28921A	Outer	TS	234
	28921	-B	28921-B	Outer	TSF	458
	28921	-B	28921-B	Outer	TSF	460
	28921	D	28921D	Outer	TDO	520

Prefix	Base	Suffix	Part Number Prefix + Base + Suffix	Part Type	Type	Page No.
	28921	D	28921D	Outer	TDO	522
	28921		28921	Outer	2TS-DM	690
	28921		28921	Outer	TS	230
	28921		28921	Outer	TS	234
	28921		28921	Outer	TS	238
	28980		28980	Inner	TDO	520
	28980		28980	Inner	TS	230
	28980		28980	Inner	TSF	458
	28985		28985	Inner	2TS-DM	690
	28985		28985	Inner	TDO	522
	28985		28985	Inner	TS	234
	28985		28985	Inner	TSF	460
	28990		28990	Inner	TS	238
	28995		28995	Inner	TDO	522
	28995		28995	Inner	TS	238
	29177		29177	Inner	TS	184
	29334		29334	Outer	TS	184
	29520	-B	29520-B	Outer	TSF	460
	29520	-B	29520-B	Outer	TSF	462
	29520	-B	29520-B	Outer	TSF	464
	29520		29520	Outer	TS	232
	29520		29520	Outer	TS	240
	29520		29520	Outer	TS	246
	29520		29520	Outer	TS	250
	29521	-B	29521-B	Outer	TSF	458
	29521		29521	Outer	TS	234
	29521		29521	Outer	TS	240
	29521		29521	Outer	TS	250
	29522		29522	Outer	TS	232
	29522		29522	Outer	TS	240
	29522		29522	Outer	TS	250
	29526	D	29526D	Outer	TDO	522
	29580		29580	Inner	TS	232
	29580		29580	Inner	TS	234
	29580		29580	Inner	TSF	458
	29580		29580	Inner	TSF	460
	29582		29582	Inner	TS	232
	29585		29585	Inner	TS	240
	29585		29585	Inner	TSF	462
	29586		29586	Inner	TDO	522
	29586		29586	Inner	TS	240
	29588		29588	Inner	TS	246
	29590		29590	Inner	TS	250
	29590		29590	Inner	TSF	464
Y7S-	29620		Y7S-29620	Spacer	2TS-IM	668
	29620	-B	29620-B	Outer	TSF	464
	29620	-B	29620-B	Outer	TSF	466
	29620		29620	Outer	2TS-IM	668
	29620		29620	Outer	TS	226
	29620		29620	Outer	TS	258
	29620		29620	Outer	TS	264
	29620		29620	Outer	TS	266
	29620		29620	Outer	TS	268
	29622	D	29622D	Outer	TDO	520
	29622	D	29622D	Outer	TDO	526
	29622	D	29622D	Outer	TDO	528

TAPERED ROLLER BEARINGS

INDEX

Prefix	Base	Suffix	Part Number Prefix + Base + Suffix	Part Type	Type	Page No.
	29622	D	29622D	Outer	TDO	530
	29624		29624	Outer	TS	258
	29630		29630	Outer	TS	260
	29665		29665	Inner	TDO	520
	29665		29665	Inner	TS	226
	29675		29675	Inner	TDO	526
	29675		29675	Inner	TS	258
	29675		29675	Inner	TS	260
	29675		29675	Inner	TSF	464
	29680		29680	Inner	TDO	528
	29680		29680	Inner	TS	264
	29681		29681	Inner	TS	264
X2S-	29685		X2S-29685	Spacer	2TS-IM	668
	29685		29685	Inner	2TS-IM	668
	29685		29685	Inner	TDO	528
	29685		29685	Inner	TS	266
	29685		29685	Inner	TSF	466
	29688		29688	Inner	TDO	530
	29688		29688	Inner	TS	268
LM	29700	LA	LM29700LA	Seal	TSL	496
LM	29710		LM29710	Outer	2S	712
LM	29710		LM29710	Outer	TS	146
LM	29710		LM29710	Outer	TSL	496
LM	29711		LM29711	Outer	TS	146
LM	29748		LM29748	Inner	2S	712
LM	29748		LM29748	Inner	TS	146
LM	29748		LM29748	Inner	TSL	496
LM	29749		LM29749	Inner	2S	712
LM	29749		LM29749	Inner	TS	146
	29820	D	29820D	Outer	TDO	566
	29820	D	29820D	Outer	TDO	570
	29820		29820	Outer	TS	358
	29820		29820	Outer	TS	362
	29875		29875	Inner	TDO	566
	29875		29875	Inner	TS	358
	29880		29880	Inner	TDO	570
	29880		29880	Inner	TS	362
	30203		30203	assembly	ISO	400
	30205		30205	assembly	ISO	400
	30206		30206	assembly	ISO	400
	30209		30209	assembly	ISO	404
X	30210	UM	X30210UM	Inner	2TS-IM	662
XGA	30210		XGA30210	inner	ISO	406
Y	30210	UM	Y30210UM	Outer	2TS-IM	662
	30210		30210	assembly	ISO	406
	30211		30211	assembly	ISO	406
	30212		30212	assembly	ISO	408
	30213		30213	assembly	ISO	408
	30214		30214	assembly	ISO	410
	30215		30215	assembly	ISO	410
X	30216	M	X30216M	Inner	2TS-IM	668
XUB-	30216		XUB-30216	inner	ISO	412
Y	30216	M	Y30216M	Outer	2TS-IM	668
YFA	30216		YFA30216	outer	ISO	412
	30216		30216	assembly	ISO	412
	30217		30217	assembly	ISO	412

Prefix	Base	Suffix	Part Number Prefix + Base + Suffix	Part Type	Type	Page No.
	30218		30218	assembly	ISO	414
	30219		30219	assembly	ISO	414
X	30220	M	X30220M	Inner	2TS-DM	696
X	30220	M	X30220M	Inner	2TS-IM	672
Y	30220	M	Y30220M	Outer	2TS-DM	696
Y	30220	M	Y30220M	Outer	2TS-IM	672
	30220		30220	assembly	ISO	414
	30221		30221	assembly	ISO	414
	30222		30222	assembly	ISO	416
X	30224	M	X30224M	Inner	2TS-IM	674
Y	30224	M	Y30224M	Outer	2TS-IM	674
	30224		30224	assembly	ISO	416
	30226		30226	assembly	ISO	416
	30228		30228	assembly	ISO	416
	30230		30230	assembly	ISO	416
	30244		30244	assembly	ISO	418
	30302		30302	assembly	ISO	400
	30303		30303	assembly	ISO	400
	30304		30304	assembly	ISO	400
	30306		30306	assembly	ISO	402
X	30307	M	X30307M	Inner	TSF	438
Y	30307	RM	Y30307RM	Outer	TSF	438
	30307		30307	assembly	ISO	402
X	30308	UM	X30308UM	Inner	TSF	442
YSA	30308	RM	YSA30308RM	Outer	TSF	442
	30308		30308	assembly	ISO	402
X	30309	M	X30309M	Inner	2TS-DM	688
X	30309	M	X30309M	Inner	TSF	448
Y	30309	M	Y30309M	Outer	2TS-DM	688
Y	30309	RM	Y30309RM	Outer	TSF	448
	30309		30309	assembly	ISO	404
X	30310	M	X30310M	Inner	TSF	452
Y	30310	RM	Y30310RM	Outer	TSF	452
	30310		30310	assembly	ISO	406
X	30311	M	X30311M	Inner	TSF	456
Y	30311	RM	Y30311RM	Outer	TSF	456
	30311		30311	assembly	ISO	406
	30312		30312	assembly	ISO	408
	30313		30313	assembly	ISO	408
	30314		30314	assembly	ISO	410
	30315		30315	assembly	ISO	410
	30316		30316	assembly	ISO	412
	30317		30317	assembly	ISO	414
T	30620		T30620	Thrust	TTHDFL	729
	31308		31308	assembly	ISO	402
	31309		31309	assembly	ISO	404
	31310		31310	assembly	ISO	406
X	31311	M	X31311M	Inner	2TS-DM	688
Y	31311	M	Y31311M	Outer	2TS-DM	688
	31311		31311	assembly	ISO	406
	31312		31312	assembly	ISO	408
	31313		31313	assembly	ISO	410
	31314		31314	assembly	ISO	410
	31315		31315	assembly	ISO	410
X	31322	M	X31322M	Inner	2TS-DM	698
Y	31322	M	Y31322M	Outer	2TS-DM	698

Prefix	Base	Suffix	Part Number Prefix + Base + Suffix	Part Type	Type	Page No.
X	31326	M	X31326M	Inner	2TS-DM	700
Y	31326	M	Y31326M	Outer	2TS-DM	700
X	31330	M	X31330M	Inner	2TS-DM	702
Y	31330	M	Y31330M	Outer	2TS-DM	702
	31520	-B	31520-B	Outer	TSF	436
	31520		31520	Outer	TS	128
	31520		31520	Outer	TS	136
	31520		31520	Outer	TS	144
	31521		31521	Outer	TS	136
	31521		31521	Outer	TS	144
	31590		31590	Inner	TS	128
	31593		31593	Inner	TS	136
	31593		31593	Inner	TSF	436
	31594		31594	Inner	TS	136
	31597		31597	Inner	TS	144
XAA	32004	X	XAA32004X	inner	ISO	400
YAA	32004	X	YAA32004X	outer	ISO	400
	32004	X	32004X	assembly	ISO	400
XAA	32005	X	XAA32005X	inner	ISO	400
YAA	32005	X	YAA32005X	outer	ISO	400
X	32006	X	X32006X	Inner	2TS-DM	688
Y	32006	X	Y32006X	Outer	2TS-DM	688
	32006	X	32006X	assembly	ISO	400
X	32007	X	X32007X	Inner	2TS-IM	660
Y	32007	X	Y32007X	Outer	2TS-IM	660
	32007	X	32007X	assembly	ISO	402
XAA	32008	X	XAA32008X	inner	ISO	402
XKA	32008	XF	XKA32008XF	inner	ISO	402
	32008	X	32008X	assembly	ISO	402
	32008	XZ	32008XZ	outer	ISO	402
X	32009	X	X32009X	Inner	2S	712
X	32009	X	X32009X	Inner	TSF	448
XAA	32009	X	XAA32009X	inner	ISO	404
XAB-	32009	X	XAB-32009X	inner	ISO	404
Y	32009	X	Y32009X	Outer	2S	712
Y	32009	XR	Y32009XR	Outer	TSF	448
	32009	X	32009X	assembly	ISO	402
	32009	X	32009X	outer	ISO	404
XAA	32010	X	XAA32010X	inner	ISO	404
XAB-	32010	X	XAB-32010X	inner	ISO	404
XAD	32010	X	XAD32010X	inner	ISO	404
XAE	32010	X	XAE32010X	inner	ISO	404
YKB-	32010	X	YKB-32010X	outer	ISO	404
	32010	X	32010X	outer	ISO	404
X	32011	X	X32011X	Inner	SR	716
Y	32011	X	Y32011X	Outer	SR	716
	32011	X	32011X	assembly	ISO	406
	32012	X	32012X	assembly	ISO	406
	32013	X	32013X	assembly	ISO	408
X	32014	X	X32014X	Inner	2TS-IM	668
Y	32014	X	Y32014X	Outer	2TS-IM	668
	32014	X	32014X	assembly	ISO	410
	32015	X	32015X	assembly	ISO	410
X	32016	X	X32016X	Inner	SR	718
Y	32016	X	Y32016X	Outer	SR	718
	32016	X	32016X	assembly	ISO	412

Prefix	Base	Suffix	Part Number Prefix + Base + Suffix	Part Type	Type	Page No.
XAA	32017	X	XAA32017X	inner	ISO	412
	32017	X	32017X	assembly	ISO	412
X	32018	X	X32018X	Inner	2TS-DM	694
XAA	32018	X	XAA32018X	inner	ISO	414
XUA	32018	X	XUA32018X	inner	ISO	412
Y	32018	X	Y32018X	Outer	2TS-DM	694
	32018	X	32018X	outer	ISO	412
	32018	X	32018X	assembly	ISO	414
	32020	X	32020X	assembly	ISO	414
XGA	32021	X	XGA32021X	inner	ISO	416
	32021	X	32021X	assembly	ISO	414
	32021	X	32021X	outer	ISO	416
	32022	X	32022X	assembly	ISO	416
XAA	32024	X	XAA32024X	inner	ISO	416
	32024	X	32024X	assembly	ISO	416
	32026	X	32026X	assembly	ISO	416
X	32028	XM	X32028XM	Inner	2TS-IM	676
XAA	32028	X	XAA32028X	inner	ISO	416
Y	32028	X	Y32028X	outer	ISO	416
Y	32028	XM	Y32028XM	Outer	2TS-IM	676
	32030	X	32030X	assembly	ISO	416
	32032	X	32032X	assembly	ISO	418
X	32034	XM	X32034XM	Inner	2TS-DM	704
Y	32034	XM	Y32034XM	Outer	2TS-DM	704
X	32036	XM	X32036XM	Inner	2TS-DM	704
Y	32036	XM	Y32036XM	Outer	2TS-DM	704
	32036	X	32036X	assembly	ISO	418
X	32038	XM	X32038XM	Inner	2TS-DM	706
X	32038	XM	X32038XM	Inner	2TS-IM	680
Y	32038	XM	Y32038XM	Outer	2TS-DM	706
Y	32038	XM	Y32038XM	Outer	2TS-IM	680
	32038	X	32038X	assembly	ISO	418
X	32040	XM	X32040XM	Inner	2TS-DM	706
Y	32040	XM	Y32040XM	Outer	2TS-DM	706
X	32044	XM	X32044XM	Inner	2TS-IM	682
X	32044	XM	X32044XM	Inner	TDO	562
Y	32044	XM	Y32044XM	Outer	2TS-IM	682
	32044	X	32044X	assembly	ISO	418
X	32048	X	X32048X	Inner	2TS-DM	708
Y	32048	X	Y32048X	Outer	2TS-DM	708
	32048	X	32048X	assembly	ISO	418
	32052	X	32052X	assembly	ISO	418
	32056	X	32056X	assembly	ISO	418
JY	32064	-Q	JY32064-Q	Spacer	2TS-DM	702
	32064	X	32064X	assembly	ISO	420
X	32205	-B	X32205-B	Inner	2TS-DM	688
Y	32205	-B	Y32205-B	Outer	2TS-DM	688
YAA	32205	-B	YAA32205-B	outer	ISO	400
	32205	-B	32205-B	inner	ISO	400
	32206	-B	32206-B	assembly	ISO	400
	32206		32206	assembly	ISO	400
	32207	-B	32207-B	assembly	ISO	402
	32207		32207	assembly	ISO	402
	32208		32208	assembly	ISO	402
X	32209		X32209	Inner	TDO	510
	32209	AD	32209AD	Outer	TDO	510

TAPERED ROLLER BEARINGS

INDEX

Prefix	Base	Suffix	Part Number Prefix + Base + Suffix	Part Type	Type	Page No.
	32209		32209	assembly	ISO	404
X	32211		X32211	Inner	2TS-IM	664
Y	32211		Y32211	Outer	2TS-IM	664
	32213		32213	assembly	ISO	408
	32214		32214	assembly	ISO	410
	32215		32215	assembly	ISO	410
	32216		32216	assembly	ISO	412
	32217		32217	assembly	ISO	412
	32219		32219	assembly	ISO	414
	32220		32220	assembly	ISO	414
	32221		32221	assembly	ISO	414
X	32222	M	X32222M	Inner	2TS-DM	698
Y	32222	M	Y32222M	Outer	2TS-DM	698
	32222		32222	assembly	ISO	416
X	32224	M	X32224M	Inner	2TS-IM	674
Y	32224	M	Y32224M	Outer	2TS-IM	674
X	32226	M	X32226M	Inner	2TS-DM	700
X	32226	M	X32226M	Inner	2TS-IM	676
Y	32226	M	Y32226M	Outer	2TS-DM	700
Y	32226	M	Y32226M	Outer	2TS-IM	676
	32244		32244	assembly	ISO	418
	32252		32252	assembly	ISO	418
	32304		32304	assembly	ISO	400
	32305		32305	assembly	ISO	400
	32306		32306	assembly	ISO	402
XBA	32308	-B	XBA32308-B	inner	ISO	402
	32308	-B	32308-B	assembly	ISO	402
	32309	-B	32309-B	assembly	ISO	404
	32310	-B	32310-B	assembly	ISO	406
	32310		32310	assembly	ISO	406
	32311	-B	32311-B	assembly	ISO	406
	32311		32311	assembly	ISO	406
	32312	-B	32312-B	assembly	ISO	408
	32312		32312	assembly	ISO	408
	32314		32314	assembly	ISO	410
	32316		32316	assembly	ISO	412
	32924		32924	assembly	ISO	416
	32928		32928	assembly	ISO	416
	32930		32930	assembly	ISO	416
X	32934	M	X32934M	Inner	2TS-DM	704
Y	32934	M	Y32934M	Outer	2TS-DM	704
	32934		32934	assembly	ISO	418
X	32936	M	X32936M	Inner	2TS-DM	704
Y	32936	M	Y32936M	Outer	2TS-DM	704
	32936		32936	assembly	ISO	418
	32940		32940	assembly	ISO	418
	32944		32944	assembly	ISO	418
	32956		32956	assembly	ISO	418
	32968		32968	assembly	ISO	420
X	32972	M	X32972M	Inner	2TS-DM	708
Y	32972	M	Y32972M	Outer	2TS-DM	708
	32972		32972	assembly	ISO	420
	33011		33011	assembly	ISO	406
	33012		33012	assembly	ISO	408
	33013		33013	assembly	ISO	408
	33014		33014	assembly	ISO	410

Prefix	Base	Suffix	Part Number Prefix + Base + Suffix	Part Type	Type	Page No.
	33015		33015	assembly	ISO	410
	33017		33017	assembly	ISO	412
	33018		33018	assembly	ISO	414
XAA	33019		XAA33019	inner	ISO	414
	33019		33019	outer	ISO	414
	33020		33020	assembly	ISO	414
	33021		33021	assembly	ISO	414
XAA	33108		XAA33108	inner	ISO	402
	33108		33108	outer	ISO	402
X	33109		X33109	Inner	TSF	448
Y	33109	R	Y33109R	Outer	TSF	448
	33109		33109	assembly	ISO	404
	33110		33110	assembly	ISO	404
	33112		33112	assembly	ISO	408
	33113		33113	assembly	ISO	408
	33114		33114	assembly	ISO	410
X	33115		X33115	Inner	2TS-DM	692
Y	33115		Y33115	Outer	2TS-DM	692
	33115		33115	assembly	ISO	410
XA	33116		XA33116	inner	ISO	412
Y	33116		Y33116	outer	ISO	412
	33116		33116	assembly	ISO	412
	33117		33117	assembly	ISO	412
	33118		33118	assembly	ISO	414
	33205		33205	assembly	ISO	400
	33208		33208	assembly	ISO	402
	33209		33209	assembly	ISO	404
XGA	33210		XGA33210	Inner	TSF	442
YSA	33210	R	YSA33210R	Outer	TSF	442
XGA	33211		XGA33211	inner	ISO	406
XLA	33211		XLA33211	inner	ISO	406
	33211		33211	outer	ISO	406
XAA	33212		XAA33212	inner	ISO	408
XAB-	33212		XAB-33212	inner	ISO	408
XGB-	33212		XGB-33212	Inner	TSF	456
Y	33212	R	Y33212R	Outer	TSF	456
	33212		33212	assembly	ISO	408
	33213		33213	assembly	ISO	408
	33215		33215	assembly	ISO	410
X	33216		X33216	Inner	2TS-IM	668
Y	33216		Y33216	Outer	2TS-IM	668
	33216		33216	assembly	ISO	412
	33217		33217	assembly	ISO	412
	33225		33225	Inner	TDO	520
	33251		33251	Inner	TDO	522
	33251		33251	Inner	TS	242
	33261		33261	Inner	TS	252
	33262		33262	Inner	TDO	524
	33262		33262	Inner	TS	252
	33269		33269	Inner	TS	256
	33275		33275	Inner	TDO	526
	33275		33275	Inner	TS	258
	33275		33275	Inner	TS	260
	33281		33281	Inner	TDO	528
	33281		33281	Inner	TS	264
	33281		33281	Inner	TSF	466

Prefix	Base	Suffix	Part Number Prefix + Base + Suffix	Part Type	Type	Page No.
X4S-	33287		X4S-33287	Spacer	2TS-IM	668
	33287	A	33287A	Inner	TS	266
	33287		33287	Inner	2TS-DM	692
	33287		33287	Inner	2TS-IM	668
	33287		33287	Inner	TDO	528
	33287		33287	Inner	TS	266
JHM	33410		JHM33410	Outer	TS	98
JHM	33449		JHM33449	Inner	TS	98
	33461		33461	Outer	TS	252
	33461		33461	Outer	TS	264
Y5S-	33462		Y5S-33462	Spacer	2TS-DM	692
Y6S-	33462		Y6S-33462	Spacer	2TS-IM	668
	33462	-B	33462-B	Outer	TSF	466
	33462	D	33462D	Outer	TDO	520
	33462	D	33462D	Outer	TDO	522
	33462	D	33462D	Outer	TDO	524
	33462	D	33462D	Outer	TDO	526
	33462	D	33462D	Outer	TDO	528
	33462		33462	Outer	2TS-DM	692
	33462		33462	Outer	2TS-IM	668
	33462		33462	Outer	TS	242
	33462		33462	Outer	TS	252
	33462		33462	Outer	TS	258
	33462		33462	Outer	TS	264
	33462		33462	Outer	TS	266
	33472		33472	Outer	TS	252
	33472		33472	Outer	TS	256
	33472		33472	Outer	TS	260
	33472		33472	Outer	TS	264
	33472		33472	Outer	TS	266
	33820	-B	33820-B	Outer	TSF	456
Y1S-	33821		Y1S-33821	Spacer	2TS-DM	688
	33821	D	33821D	Outer	TDO	506
	33821	D	33821D	Outer	TDO	510
	33821	D	33821D	Outer	TDO	514
	33821	D	33821D	Outer	TDO	516
	33821		33821	Outer	2TS-DM	688
	33821		33821	Outer	TS	154
	33821		33821	Outer	TS	178
	33821		33821	Outer	TS	204
	33821		33821	Outer	TS	212
	33821		33821	Outer	TS	214
	33822		33822	Outer	TS	178
	33822		33822	Outer	TS	204
	33822		33822	Outer	TS	214
	33880		33880	Inner	TDO	506
	33880		33880	Inner	TS	154
	33885		33885	Inner	TDO	510
	33885		33885	Inner	TS	178
	33889		33889	Inner	TDO	514
	33889		33889	Inner	TS	204
	33890		33890	Inner	TDO	516
	33890		33890	Inner	TS	212
	33891		33891	Inner	TDO	516
	33891		33891	Inner	TS	212
NA	33895	SW	NA33895SW	Inner	TNASW	650

Prefix	Base	Suffix	Part Number Prefix + Base + Suffix	Part Type	Type	Page No.
	33895		33895	Inner	2TS-DM	688
	33895		33895	Inner	TDO	516
	33895		33895	Inner	TS	214
	33895		33895	Inner	TSF	456
	34274		34274	Inner	TDO	528
	34274		34274	Inner	TS	262
	34274		34274	Inner	TSF	464
	34275		34275	Inner	TS	262
	34275		34275	Inner	TSF	464
	34294		34294	Inner	TDO	530
	34294		34294	Inner	TS	268
	34300		34300	Inner	TDO	530
	34300		34300	Inner	TS	270
	34300		34300	Inner	TSF	468
	34301		34301	Inner	2TS-DM	692
	34301		34301	Inner	TDO	530
	34301		34301	Inner	TS	270
	34301		34301	Inner	TSF	468
	34306		34306	Inner	TDO	532
	34306		34306	Inner	TS	276
	34306		34306	Inner	TSF	468
	34307		34307	Inner	TS	276
	34472	X	34472X	Outer	TS	276
Y4S-	34478		Y4S-34478	Spacer	2TS-DM	692
	34478	D	34478D	Outer	TDO	528
	34478	D	34478D	Outer	TDO	530
	34478	D	34478D	Outer	TDO	532
	34478		34478	Outer	2TS-DM	692
	34478		34478	Outer	TS	262
	34478		34478	Outer	TS	270
	34478		34478	Outer	TS	276
	34481	-B	34481-B	Outer	TSF	464
	34481	-B	34481-B	Outer	TSF	468
	34492		34492	Outer	TS	262
	34500		34500	Outer	TS	268
	34500		34500	Outer	TS	270
NP	34947		NP034947	Outer	TDI	614
	35175		35175	Inner	TS	174
	35176		35176	Inner	TS	174
	35326		35326	Outer	TS	174
NP	35656		NP035656	Inner	TS	380
	36137		36137	Inner	TS	136
	36300		36300	Outer	TS	136
	36620	-B	36620-B	Outer	TSF	482
	36620	D	36620D	Outer	TDO	552
	36620		36620	Outer	TS	326
Y1S-	36626		Y1S-36626	Spacer	2TS-IM	676
	36626		36626	Outer	2TS-IM	676
	36626		36626	Outer	TS	326
	36686		36686	Inner	TS	326
	36686		36686	Inner	TSF	482
X4S-	36690		X4S-36690	Spacer	2TS-IM	676
	36690		36690	Inner	2TS-IM	676
	36690		36690	Inner	TDO	552
	36690		36690	Inner	TS	326
	36690		36690	Inner	TSF	482

TAPERED ROLLER BEARINGS

INDEX

Prefix	Base	Suffix	Part Number Prefix + Base + Suffix	Part Type	Type	Page No.
	36691		36691	Inner	TS	326
	36920	CD	36920CD	Outer	TDO	556
	36990		36990	Inner	TDO	556
K	37425		K37425	Inner	2TS-DM	698
X6S-	37425		X6S-37425	Spacer	2TS-IM	672
	37425		37425	Inner	2TS-IM	672
	37425		37425	Inner	TDO	544
	37425		37425	Inner	TS	310
	37431	A	37431A	Inner	TS	310
	37431		37431	Inner	TDO	544
	37431		37431	Inner	TS	310
	37431		37431	Inner	TSF	478
K	37625		K37625	Outer	2TS-DM	698
	37625	-B	37625-B	Outer	TSF	478
	37625		37625	Outer	2TS-IM	672
	37625		37625	Outer	TS	310
	37626	D	37626D	Outer	TDO	544
M	38510		M38510	Outer	TS	126
M	38510		M38510	Outer	TS	132
M	38511		M38511	Outer	TS	130
M	38511		M38511	Outer	TS	140
M	38514		M38514	Outer	TS	132
M	38545		M38545	Inner	TS	126
M	38547		M38547	Inner	TS	140
M	38549		M38549	Inner	TS	130
M	38549		M38549	Inner	TS	132
	38820		38820	Outer	TS	362
	38880		38880	Inner	TS	362
	38884		38884	Inner	TS	362
	38885		38885	Inner	TS	362
	38886		38886	Inner	TS	362
	39236		39236	Inner	TS	232
	39236		39236	Inner	TSF	458
	39250		39250	Inner	TS	240
	39250		39250	Inner	TS	242
	39250		39250	Inner	TSF	462
	39412	-B	39412-B	Outer	TSF	458
	39412	-B	39412-B	Outer	TSF	462
	39412		39412	Outer	TS	232
	39412		39412	Outer	TS	240
	39422		39422	Outer	TS	240
	39433		39433	Outer	TS	232
	39433		39433	Outer	TS	242
Y1S-	39520		Y1S-39520	Spacer	2TS-DM	690
Y5S-	39520		Y5S-39520	Spacer	2TS-IM	666
	39520		39520	Outer	2TS-DM	690
	39520		39520	Outer	2TS-IM	666
	39520		39520	Outer	TDI	600
	39520		39520	Outer	TS	210
	39520		39520	Outer	TS	216
	39520		39520	Outer	TS	228
	39520		39520	Outer	TS	242
	39520		39520	Outer	TS	246
	39520		39520	Outer	TS	252
	39521	P	39521P	Outer	2S	714
	39521		39521	Outer	2TS-IM	664

Prefix	Base	Suffix	Part Number Prefix + Base + Suffix	Part Type	Type	Page No.
	39521		39521	Outer	2S	714
	39521		39521	Outer	TS	210
	39521		39521	Outer	TS	228
	39521		39521	Outer	TS	252
	39528		39528	Outer	TS	246
	39573		39573	Inner	TS	210
	39575		39575	Inner	TS	210
	39578		39578	Inner	TS	216
X1S-	39580		X1S-39580	Spacer	2TS-IM	664
X3S-	39580		X3S-39580	Spacer	2S	714
	39580		39580	Inner	2TS-IM	664
	39580		39580	Inner	2S	714
	39580		39580	Inner	TS	228
	39581		39581	Inner	TS	228
	39585	A	39585A	Inner	TS	242
	39585	D	39585D	Inner	TDI	600
	39585	P	39585P	Inner	2S	714
	39585		39585	Inner	TS	242
	39586		39586	Inner	TS	246
	39589		39589	Inner	TS	252
X1S-	39590		X1S-39590	Spacer	2TS-IM	666
	39590		39590	Inner	2TS-DM	690
	39590		39590	Inner	2TS-IM	666
	39590		39590	Inner	2S	714
	39590		39590	Inner	TS	252
	39591		39591	Inner	TS	252
	41100		41100	Inner	TS	104
	41100		41100	Inner	TSF	426
	41106		41106	Inner	TS	106
	41106		41106	Inner	TSF	428
NA	41125		NA41125	Inner	TNA	638
	41125		41125	Inner	TS	110
	41125		41125	Inner	TSF	428
	41126		41126	Inner	TS	110
	41286	-B	41286-B	Outer	TSF	426
	41286	-B	41286-B	Outer	TSF	428
	41286		41286	Outer	TS	104
	41286		41286	Outer	TS	106
	41286		41286	Outer	TS	110
	41294	D	41294D	Outer	TNA	638
	42346		42346	Inner	TDO	536
	42346		42346	Inner	TS	290
	42350		42350	Inner	TDO	536
	42350		42350	Inner	TS	290
	42350		42350	Inner	TSF	472
	42354	X	42354X	Inner	TS	294
	42362	D	42362D	Inner	TDI	602
	42362		42362	Inner	TDO	538
	42362		42362	Inner	TS	296
	42362		42362	Inner	TSF	474
	42368		42368	Inner	TDO	538
	42368		42368	Inner	TS	298
	42368		42368	Inner	TSF	474
	42373		42373	Inner	TS	298
X1S-	42375		X1S-42375	Spacer	2TS-IM	670
	42375	A	42375A	Inner	TS	300

Prefix	Base	Suffix	Part Number Prefix + Base + Suffix	Part Type	Type	Page No.
	42375		42375	Inner	2TS-IM	670
	42375		42375	Inner	TDO	538
	42375		42375	Inner	TS	300
	42375		42375	Inner	TSF	474
	42376		42376	Inner	TDO	538
	42376		42376	Inner	TS	300
	42381		42381	Inner	2TS-DM	696
	42381		42381	Inner	TDO	540
	42381		42381	Inner	TS	302
	42381		42381	Inner	TSF	476
Y3S-	42584		Y3S-42584	Spacer	2TS-DM	696
Y6S-	42584		Y6S-42584	Spacer	2TS-IM	670
	42584		42584	Outer	2TS-DM	696
	42584		42584	Outer	2TS-IM	670
	42584		42584	Outer	TDI	602
	42584		42584	Outer	TS	290
	42584		42584	Outer	TS	296
	42584		42584	Outer	TS	298
	42584		42584	Outer	TS	300
	42584		42584	Outer	TS	302
	42587	-B	42587-B	Outer	TSF	472
	42587	-B	42587-B	Outer	TSF	474
	42587	-B	42587-B	Outer	TSF	476
	42587	D	42587D	Outer	TDO	536
	42587	D	42587D	Outer	TDO	538
	42587	D	42587D	Outer	TDO	540
	42587		42587	Outer	TS	290
	42587		42587	Outer	TS	294
	42587		42587	Outer	TS	296
	42587		42587	Outer	TS	298
	42587		42587	Outer	TS	300
	42587		42587	Outer	TS	302
	42590		42590	Outer	TS	298
Y3S-	42620		Y3S-42620	Spacer	2TS-DM	692
	42620	-B	42620-B	Outer	TSF	468
	42620		42620	Outer	2TS-DM	692
	42620		42620	Outer	TS	266
	42620		42620	Outer	TS	270
	42620		42620	Outer	TS	276
	42623	-B	42623-B	Outer	TSF	468
	42624		42624	Outer	TS	270
	42683		42683	Inner	TS	266
	42686		42686	Inner	TS	270
	42687		42687	Inner	2TS-DM	692
	42687		42687	Inner	TS	270
	42687		42687	Inner	TSF	468
	42688		42688	Inner	TS	270
	42690		42690	Inner	TS	276
	42690		42690	Inner	TSF	468
	43096		43096	Inner	TDO	500
	43096		43096	Inner	TS	98
	43112		43112	Inner	TDO	502
	43112		43112	Inner	TS	110
	43117		43117	Inner	TS	112
	43118		43118	Inner	TDO	502
	43118		43118	Inner	TS	116

Prefix	Base	Suffix	Part Number Prefix + Base + Suffix	Part Type	Type	Page No.
	43125		43125	Inner	TDO	504
	43125		43125	Inner	TS	124
NA	43131		NA43131	Inner	TNA	638
	43131		43131	Inner	TDO	504
	43131		43131	Inner	TS	130
	43132		43132	Inner	TDO	504
	43132		43132	Inner	TS	130
	43300		43300	Outer	TS	112
	43300		43300	Outer	TS	116
	43300		43300	Outer	TS	124
	43312		43312	Outer	TS	98
	43312		43312	Outer	TS	110
	43312		43312	Outer	TS	116
	43312		43312	Outer	TS	124
	43312		43312	Outer	TS	130
	43319	D	43319D	Outer	TDO	500
	43319	D	43319D	Outer	TDO	502
	43319	D	43319D	Outer	TDO	504
	43319	D	43319D	Outer	TNA	638
	44131		44131	Inner	TS	130
NA	44143		NA44143	Inner	TNA	638
	44143		44143	Inner	TDO	506
	44143		44143	Inner	TS	144
	44143		44143	Inner	TSF	438
	44150		44150	Inner	TDO	506
	44150		44150	Inner	TS	154
	44150		44150	Inner	TSF	440
NA	44156		NA44156	Inner	TNA	638
	44156		44156	Inner	TDO	508
	44156		44156	Inner	TS	158
	44156		44156	Inner	TSF	442
	44157	X	44157X	Inner	TS	160
	44157		44157	Inner	TSF	442
	44158		44158	Inner	TS	158
	44158		44158	Inner	TSF	442
	44162		44162	Inner	TDO	508
	44162		44162	Inner	TS	166
	44162		44162	Inner	TSF	444
NA	44163		NA44163	Inner	TNA	638
	44348	-B	44348-B	Outer	TSF	438
	44348	-B	44348-B	Outer	TSF	440
	44348	-B	44348-B	Outer	TSF	442
	44348	-B	44348-B	Outer	TSF	444
	44348	D	44348D	Outer	TNA	638
	44348		44348	Outer	TS	130
	44348		44348	Outer	TS	144
	44348		44348	Outer	TS	154
	44348		44348	Outer	TS	158
	44348		44348	Outer	TS	160
	44348		44348	Outer	TS	166
	44363	D	44363D	Outer	TDO	506
	44363	D	44363D	Outer	TDO	508
	44363	D	44363D	Outer	TNA	638
L	44600	LA	L44600LA	Seal	TSL	496
L	44600	LB	L44600LB	Seal	TSL	496
L	44600	LC	L44600LC	Seal	TSL	496

TAPERED ROLLER BEARINGS

INDEX

Prefix	Base	Suffix	Part Number Prefix + Base + Suffix	Part Type	Type	Page No.
L	44610		L44610	Outer	2S	712
L	44610		L44610	Outer	TS	96
L	44610		L44610	Outer	TS	100
L	44610		L44610	Outer	TS	106
L	44610		L44610	Outer	TSL	496
L	44613		L44613	Outer	TS	100
L	44613		L44613	Outer	TS	104
L	44613		L44613	Outer	TS	106
JL	44615		JL44615	Outer	TS	98
L	44640		L44640	Inner	TS	96
JL	44642	A	JL44642A	Inner	TS	98
L	44642		L44642	Inner	TS	100
L	44642		L44642	Inner	TSL	496
L	44643	X	L44643X	Inner	TSL	496
L	44643		L44643	Inner	2S	712
L	44643		L44643	Inner	TS	100
L	44643		L44643	Inner	TSL	496
L	44645		L44645	Inner	TS	104
L	44649		L44649	Inner	TS	106
	45220	-B	45220-B	Outer	TSF	452
	45220	-B	45220-B	Outer	TSF	458
	45220		45220	Outer	TS	182
	45220		45220	Outer	TS	194
	45220		45220	Outer	TS	206
	45220		45220	Outer	TS	214
	45220		45220	Outer	TS	226
Y1S-	45221		Y1S-45221	Spacer	2TS-IM	664
	45221		45221	Outer	2TS-IM	664
	45221		45221	Outer	TS	194
	45221		45221	Outer	TS	206
	45221		45221	Outer	TS	214
	45221		45221	Outer	TS	226
	45280		45280	Inner	TS	182
	45282		45282	Inner	TS	194
	45284		45284	Inner	TS	206
	45285	A	45285A	Inner	TS	206
	45285	A	45285A	Inner	TSF	452
	45285		45285	Inner	TS	206
	45285		45285	Inner	TSF	452
	45287		45287	Inner	TS	214
X1S-	45289		X1S-45289	Spacer	2TS-IM	664
	45289		45289	Inner	2TS-IM	664
	45289		45289	Inner	TS	226
	45290		45290	Inner	TS	226
	45290		45290	Inner	TSF	458
	45291		45291	Inner	TS	226
	45291		45291	Inner	TSF	458
L	45410		L45410	Outer	TS	110
L	45449		L45449	Inner	TS	110
T	45750		T45750	Thrust	TTHDFL	729
	46143		46143	Inner	TS	146
	46175		46175	Inner	TS	178
	46176		46176	Inner	TS	178
	46368		46368	Outer	TS	146
	46368		46368	Outer	TS	178
Y2S-	46720		Y2S-46720	Spacer	2TS-DM	702

Prefix	Base	Suffix	Part Number Prefix + Base + Suffix	Part Type	Type	Page No.
	46720	-B	46720-B	Outer	TSF	482
	46720	CD	46720CD	Outer	TDO	554
	46720	CD	46720CD	Outer	TNASWE	654
	46720		46720	Outer	2TS-DM	702
	46720		46720	Outer	2TS-IM	678
	46720		46720	Outer	TDI	604
	46720		46720	Outer	TS	332
	46720		46720	Outer	TS	334
	46780		46780	Inner	2TS-DM	702
	46780		46780	Inner	TDO	554
	46780		46780	Inner	TS	332
	46780		46780	Inner	TSF	482
NA	46790	SW	NA46790SW	Inner	TNASWE	654
X4S-	46790		X4S-46790	Spacer	2TS-IM	678
	46790	A	46790A	Inner	TS	332
	46790	D	46790D	Inner	TDI	604
	46790		46790	Inner	2TS-IM	678
	46790		46790	Inner	TDO	554
	46790		46790	Inner	TS	332
	46790		46790	Inner	TSF	482
	46792		46792	Inner	TDO	554
	46792		46792	Inner	TS	334
Y1S-	47420		Y1S-47420	Spacer	2TS-DM	692
	47420	A	47420A	Outer	TS	260
	47420	D	47420D	Outer	TDO	526
	47420	D	47420D	Outer	TDO	528
	47420		47420	Outer	2TS-DM	692
	47420		47420	Outer	TS	260
	47420		47420	Outer	TS	264
	47423		47423	Outer	TS	264
	47487		47487	Inner	2TS-DM	692
	47487		47487	Inner	TDO	526
	47487		47487	Inner	TS	260
	47490		47490	Inner	TDO	528
	47490		47490	Inner	TS	264
	47620	A	47620A	Outer	TS	272
	47620	-B	47620-B	Outer	TSF	470
	47620		47620	Outer	TS	266
	47620		47620	Outer	TS	272
	47620		47620	Outer	TS	280
	47620		47620	Outer	TS	282
	47620		47620	Outer	TS	286
	47621		47621	Outer	TS	272
	47621		47621	Outer	TS	282
	47675		47675	Inner	TS	266
	47678		47678	Inner	TS	272
	47679		47679	Inner	TS	272
	47680		47680	Inner	TS	272
	47681		47681	Inner	TS	280
	47681		47681	Inner	TSF	470
	47685		47685	Inner	TS	282
	47685		47685	Inner	TSF	470
	47686		47686	Inner	TS	282
	47686		47686	Inner	TSF	470
	47687		47687	Inner	TS	282
	47688		47688	Inner	TS	286

Prefix	Base	Suffix	Part Number Prefix + Base + Suffix	Part Type	Type	Page No.
Y3S-	47820		Y3S-47820	Spacer	2TS-IM	670
	47820		47820	Outer	2TS-IM	670
	47820		47820	Outer	TS	296
	47820		47820	Outer	TS	298
	47820		47820	Outer	TS	300
	47825	-B	47825-B	Outer	TSF	474
	47825	-B	47825-B	Outer	TSF	476
	47890		47890	Inner	TS	296
	47890		47890	Inner	TSF	474
X2S-	47896		X2S-47896	Spacer	2TS-IM	670
	47896		47896	Inner	2TS-IM	670
	47896		47896	Inner	TS	298
	47896		47896	Inner	TSF	476
	47898		47898	Inner	TS	300
	48120		48120	Outer	2TS-IM	672
	48120		48120	Outer	TS	310
X3S-	48190		X3S-48190	Spacer	2TS-IM	672
	48190		48190	Inner	2TS-IM	672
	48190		48190	Inner	TS	310
Y5S-	48220		Y5S-48220	Spacer	2TS-DM	700
Y7S-	48220		Y7S-48220	Spacer	2TS-IM	674
	48220	-B	48220-B	Outer	TSF	480
	48220	D	48220D	Outer	TDO	546
	48220	D	48220D	Outer	TNA	644
	48220	D	48220D	Outer	TNASWE	654
	48220		48220	Outer	2TS-DM	700
	48220		48220	Outer	2TS-IM	674
	48220		48220	Outer	TS	316
	48220		48220	Outer	TS	318
	48282		48282	Inner	TDO	546
	48282		48282	Inner	TS	316
	48286		48286	Inner	TDO	546
	48286		48286	Inner	TS	318
	48286		48286	Inner	TSF	480
NA	48290	SW	NA48290SW	Inner	TNASWE	654
X1S-	48290		X1S-48290	Spacer	2TS-IM	674
	48290		48290	Inner	2TS-DM	700
	48290		48290	Inner	2TS-IM	674
	48290		48290	Inner	TDO	546
	48290		48290	Inner	TS	318
	48290		48290	Inner	TSF	480
NA	48291		NA48291	Inner	TNA	644
	48320	-B	48320-B	Outer	TSF	480
	48320	D	48320D	Outer	TDO	548
	48320	D	48320D	Outer	TDO	550
	48320	D	48320D	Outer	TNA	644
	48320		48320	Outer	2TS-IM	676
	48320		48320	Outer	TS	322
	48320		48320	Outer	TS	324
	48328		48328	Outer	TS	324
NA	48385		NA48385	Inner	TNA	644
	48385		48385	Inner	TDO	548
	48385		48385	Inner	TS	322
	48385		48385	Inner	TSF	480
X6S-	48393		X6S-48393	Spacer	2TS-IM	676
	48393		48393	Inner	2TS-IM	676

Prefix	Base	Suffix	Part Number Prefix + Base + Suffix	Part Type	Type	Page No.
	48393		48393	Inner	TDO	550
	48393		48393	Inner	TS	324
LM	48500	LA	LM48500LA	Seal	TSL	496
	48506		48506	Inner	TS	320
LM	48510	EE	LM48510EE	Spacer	2TS-DM	688
LM	48510		LM48510	Outer	2TS-DM	688
LM	48510		LM48510	Outer	2S	712
LM	48510		LM48510	Outer	TS	130
LM	48510		LM48510	Outer	TSL	496
LM	48511	A	LM48511A	Outer	TS	130
LM	48514		LM48514	Outer	TS	132
LM	48548	A	LM48548A	Inner	TS	130
LM	48548	XE	LM48548XE	Spacer	2S	712
LM	48548		LM48548	Inner	2TS-DM	688
LM	48548		LM48548	Inner	2S	712
LM	48548		LM48548	Inner	TS	130
LM	48548		LM48548	Inner	TS	132
LM	48548		LM48548	Inner	TSL	496
LM	48549	X	LM48549X	Inner	TS	130
LM	48549		LM48549	Inner	TS	130
	48620	-B	48620-B	Outer	TSF	482
	48620	D	48620D	Outer	TDO	550
	48620	D	48620D	Outer	TNA	644
	48620	D	48620D	Outer	TNASWE	654
	48620		48620	Outer	TDI	604
	48620		48620	Outer	TS	326
	48680	D	48680D	Inner	TDI	604
	48684		48684	Inner	TS	326
NA	48685	SW	NA48685SW	Inner	TNASWE	654
	48685		48685	Inner	TDO	550
	48685		48685	Inner	TS	326
	48685		48685	Inner	TSF	482
NA	48686		NA48686	Inner	TNA	644
	48750		48750	Outer	TS	320
	48920	D	48920D	Outer	TNASWE	654
NA	48990	SW	NA48990SW	Inner	TNASWE	654
	49151		49151	Inner	TS	154
	49162		49162	Inner	TS	168
	49175		49175	Inner	TS	176
	49176		49176	Inner	TS	178
	49368		49368	Outer	TS	154
	49368		49368	Outer	TS	168
	49368		49368	Outer	TS	176
	49368		49368	Outer	TS	178
	49520	-B	49520-B	Outer	TSF	446
	49520	-B	49520-B	Outer	TSF	452
	49520		49520	Outer	TS	180
	49520		49520	Outer	TS	192
	49520		49520	Outer	TS	206
	49521		49521	Outer	TS	192
	49522		49522	Outer	TS	206
	49576		49576	Inner	TS	180
	49576		49576	Inner	TSF	446
	49577		49577	Inner	TS	180
	49580		49580	Inner	TS	192
	49585		49585	Inner	TS	206

TAPERED ROLLER BEARINGS

INDEX

Prefix	Base	Suffix	Part Number Prefix + Base + Suffix	Part Type	Type	Page No.
	49585		49585	Inner	TSF	452
NA	52375		NA52375	Inner	TNA	642
	52375		52375	Inner	TDO	538
	52375		52375	Inner	TS	300
	52375		52375	Inner	TSF	474
	52387		52387	Inner	TDO	540
	52387		52387	Inner	TS	302
	52387		52387	Inner	TSF	476
	52393		52393	Inner	TDO	540
	52393		52393	Inner	TS	304
	52393		52393	Inner	TS	306
	52394	X	52394X	Inner	TS	304
	52400	D	52400D	Inner	TDI	602
	52400		52400	Inner	TDO	542
	52400		52400	Inner	TS	306
	52400		52400	Inner	TSF	476
	52400		52400	Inner	TSF	478
	52401		52401	Inner	TDO	542
	52401		52401	Inner	TS	306
LL	52510		LL52510	Outer	TS	94
LL	52549		LL52549	Inner	TS	94
	52618	-B	52618-B	Outer	TSF	478
	52618		52618	Outer	TDI	602
	52618		52618	Outer	TS	300
	52618		52618	Outer	TS	302
	52618		52618	Outer	TS	304
	52618		52618	Outer	TS	306
	52630	X	52630X	Outer	TS	304
	52630	X	52630X	Outer	TS	306
	52630	XB	52630XB	Outer	TSF	474
	52630	XB	52630XB	Outer	TSF	478
	52637	-B	52637-B	Outer	TSF	474
	52637	-B	52637-B	Outer	TSF	476
	52637	D	52637D	Outer	TDO	538
	52637	D	52637D	Outer	TDO	540
	52637	D	52637D	Outer	TDO	542
	52637	D	52637D	Outer	TNA	642
	52637		52637	Outer	TS	300
	52637		52637	Outer	TS	302
	52637		52637	Outer	TS	304
	52637		52637	Outer	TS	306
	52638		52638	Outer	TDI	602
	52638		52638	Outer	TS	300
	52638		52638	Outer	TS	306
	53150		53150	Inner	TDO	506
	53150		53150	Inner	TS	154
	53162		53162	Inner	TS	168
	53162		53162	Inner	TSF	444
NA	53176		NA53176	Inner	TNA	640
	53176		53176	Inner	TS	178
	53176		53176	Inner	TS	180
	53176		53176	Inner	TSF	446
	53177		53177	Inner	TDO	510
	53177		53177	Inner	TS	178
	53177		53177	Inner	TS	180
	53178		53178	Inner	TDO	510

Prefix	Base	Suffix	Part Number Prefix + Base + Suffix	Part Type	Type	Page No.
	53178		53178	Inner	TS	178
T	53250		T53250	Thrust	TTHDFL	729
	53375		53375	Outer	TS	154
	53375		53375	Outer	TS	168
	53375		53375	Outer	TS	178
	53376	D	53376D	Outer	TDO	506
	53376	D	53376D	Outer	TDO	510
	53376	D	53376D	Outer	TNA	640
	53377		53377	Outer	TS	178
	53387	-B	53387-B	Outer	TSF	444
	53387	-B	53387-B	Outer	TSF	446
	53387	X	53387X	Outer	TS	180
	53387		53387	Outer	TS	154
	53387		53387	Outer	TS	168
	53387		53387	Outer	TS	180
	53390	D	53390D	Outer	TDO	510
	53390	D	53390D	Outer	TNA	640
	53398		53398	Outer	TS	180
NP	54313		NP054313	Outer	TS	380
	55175	C	55175C	Inner	TS	182
	55175		55175	Inner	TDO	510
	55175		55175	Inner	TS	182
	55176	C	55176C	Inner	TS	182
	55176	C	55176C	Inner	TS	184
	55176		55176	Inner	TDO	510
	55187	C	55187C	Inner	TS	194
	55187		55187	Inner	TDO	512
	55187		55187	Inner	TS	194
	55196		55196	Inner	TS	198
	55197		55197	Inner	TDO	512
NA	55200		NA55200	Inner	TNA	640
	55200	C	55200C	Inner	TDO	514
	55200	C	55200C	Inner	TS	208
	55200		55200	Inner	TDO	514
	55200		55200	Inner	TDO	516
	55200		55200	Inner	TS	208
	55200		55200	Inner	TSF	452
	55206	C	55206C	Inner	TS	214
	55206		55206	Inner	TDO	516
	55206		55206	Inner	TS	214
	55206		55206	Inner	TSF	454
	55433	D	55433D	Outer	TDO	512
	55433	D	55433D	Outer	TDO	514
	55433	D	55433D	Outer	TDO	516
	55437	-B	55437-B	Outer	TSF	452
	55437	-B	55437-B	Outer	TSF	454
	55437		55437	Outer	TS	182
	55437		55437	Outer	TS	194
	55437		55437	Outer	TS	198
	55437		55437	Outer	TS	208
	55437		55437	Outer	TS	214
	55443		55443	Outer	TS	182
	55443		55443	Outer	TS	184
	55443		55443	Outer	TS	194
	55443		55443	Outer	TS	208
	55443		55443	Outer	TS	214

Prefix	Base	Suffix	Part Number Prefix + Base + Suffix	Part Type	Type	Page No.
	55444	D	55444D	Outer	TDO	510
	55444	D	55444D	Outer	TDO	512
	55444	D	55444D	Outer	TDO	516
	55444	D	55444D	Outer	TNA	640
NA	56393	SW	NA56393SW	Inner	TNASWE	654
	56418		56418	Inner	2TS-DM	698
	56418		56418	Inner	TDO	544
	56418		56418	Inner	TS	308
NA	56425	SW	NA56425SW	Inner	TNASWE	654
	56425		56425	Inner	TDO	544
	56425		56425	Inner	TS	310
	56425		56425	Inner	TSF	478
	56426		56426	Inner	TS	310
	56649	D	56649D	Outer	TNASWE	654
Y2S-	56650		Y2S-56650	Spacer	2TS-DM	698
	56650	-B	56650-B	Outer	TSF	478
	56650	CD	56650CD	Outer	TDO	544
	56650	D	56650D	Outer	TDO	544
	56650	D	56650D	Outer	TNASWE	654
	56650		56650	Outer	2TS-DM	698
	56650		56650	Outer	TS	308
	56650		56650	Outer	TS	310
	56662		56662	Outer	TS	310
	59175		59175	Inner	TS	182
	59175		59175	Inner	TSF	446
	59176		59176	Inner	TS	182
	59187		59187	Inner	TS	194
	59187		59187	Inner	TSF	450
	59188		59188	Inner	TS	194
	59200		59200	Inner	TS	206
	59200		59200	Inner	TS	208
	59201		59201	Inner	TS	208
	59201		59201	Inner	TSF	452
	59412	-B	59412-B	Outer	TSF	452
	59412		59412	Outer	TS	182
	59412		59412	Outer	TS	194
	59412		59412	Outer	TS	206
	59412		59412	Outer	TS	208
	59413		59413	Outer	TS	182
	59413		59413	Outer	TS	208
	59425		59425	Outer	TS	182
	59425		59425	Outer	TS	208
	59429	-B	59429-B	Outer	TSF	446
	59429	-B	59429-B	Outer	TSF	450
	59429		59429	Outer	TS	194
NA	64432	SW	NA64432SW	Inner	TNASWE	654
	64432		64432	Inner	TS	310
	64433		64433	Inner	TDO	544
	64433		64433	Inner	TS	312
	64433		64433	Inner	TSF	478
X1S-	64450		X1S-64450	Spacer	2TS-IM	674
	64450		64450	Inner	2TS-DM	698
	64450		64450	Inner	2TS-IM	674
	64450		64450	Inner	TDO	546
	64450		64450	Inner	TS	312
	64450		64450	Inner	TSF	478

Prefix	Base	Suffix	Part Number Prefix + Base + Suffix	Part Type	Type	Page No.
	64452	A	64452A	Inner	TS	314
Y2S-	64700		Y2S-64700	Spacer	2TS-DM	698
Y8S-	64700		Y8S-64700	Spacer	2TS-IM	674
	64700	-B	64700-B	Outer	TSF	478
	64700	D	64700D	Outer	TDO	544
	64700	D	64700D	Outer	TDO	546
	64700		64700	Outer	2TS-DM	698
	64700		64700	Outer	2TS-IM	674
	64700		64700	Outer	TS	312
	64700		64700	Outer	TS	314
	64701	X	64701X	Outer	TS	312
	64708	D	64708D	Outer	TNASWE	654
	64708		64708	Outer	TS	310
	64708		64708	Outer	TS	312
	64713		64713	Outer	TS	312
	64713		64713	Outer	TS	314
X1S-	65200		X1S-65200	Spacer	2TS-IM	664
	65200		65200	Inner	2TS-IM	664
	65200		65200	Inner	TS	210
	65200		65200	Inner	TSF	452
	65212		65212	Inner	TS	218
	65225		65225	Inner	TS	228
	65225		65225	Inner	TSF	456
	65231		65231	Inner	TS	230
	65235		65235	Inner	TS	230
	65237	A	65237A	Inner	TS	236
	65237		65237	Inner	TS	236
Y1S-	65320		Y1S-65320	Spacer	2TS-IM	662
	65320	-B	65320-B	Outer	TSF	450
	65320		65320	Outer	2TS-IM	662
	65320		65320	Outer	TS	170
	65320		65320	Outer	TS	184
	65320		65320	Outer	TS	196
	65320		65320	Outer	TS	210
	65383		65383	Inner	TS	170
	65384		65384	Inner	TS	184
	65385		65385	Inner	TS	184
X1S-	65390		X1S-65390	Spacer	2TS-IM	662
	65390		65390	Inner	2TS-IM	662
	65390		65390	Inner	TS	196
	65390		65390	Inner	TSF	450
	65395		65395	Inner	TS	210
Y1S-	65500		Y1S-65500	Spacer	2TS-IM	664
	65500	-B	65500-B	Outer	TSF	452
	65500		65500	Outer	2TS-IM	664
	65500		65500	Outer	TS	210
	65500		65500	Outer	TS	218
	65500		65500	Outer	TS	228
	65500		65500	Outer	TS	230
	65500		65500	Outer	TS	236
	65501		65501	Outer	TS	236
	65537		65537	Outer	TS	236
	65550	-B	65550-B	Outer	TSF	456
	66187		66187	Inner	TDO	512
	66187		66187	Inner	TS	196
	66200		66200	Inner	TDO	516

TAPERED ROLLER BEARINGS

INDEX

Prefix	Base	Suffix	Part Number Prefix + Base + Suffix	Part Type	Type	Page No.
	66200		66200	Inner	TS	210
NA	66212		NA66212	Inner	TNA	640
	66212		66212	Inner	TDO	516
	66212		66212	Inner	TS	216
	66225		66225	Inner	TDO	520
	66225		66225	Inner	TS	228
	66461		66461	Outer	TS	216
	66462	D	66462D	Outer	TDO	512
	66462	D	66462D	Outer	TDO	516
	66462	D	66462D	Outer	TDO	520
	66462	D	66462D	Outer	TNA	640
	66462		66462	Outer	TS	196
	66462		66462	Outer	TS	210
	66462		66462	Outer	TS	216
	66462		66462	Outer	TS	228
	66520		66520	Outer	TS	218
	66520		66520	Outer	TS	228
	66520		66520	Outer	TS	230
	66520		66520	Outer	TS	234
	66522	D	66522D	Outer	TDO	520
	66522	D	66522D	Outer	TDO	522
	66584		66584	Inner	TS	218
	66585		66585	Inner	TDO	522
	66585		66585	Inner	TS	234
	66586		66586	Inner	TS	230
	66587		66587	Inner	TS	228
	66589		66589	Inner	TDO	520
LM	67000	LA	LM67000LA	Seal	TSL	496
LM	67010	-B	LM67010-B	Outer	TSF	432
LM	67010	-BA	LM67010-BA	Outer	TSF	432
LM	67010		LM67010	Outer	2S	712
LM	67010		LM67010	Outer	TS	106
LM	67010		LM67010	Outer	TS	108
LM	67010		LM67010	Outer	TS	118
LM	67010		LM67010	Outer	TSL	496
LM	67014		LM67014	Outer	TS	118
JLM	67042		JLM67042	Inner	TS	106
LM	67043		LM67043	Inner	TS	108
LM	67045		LM67045	Inner	TS	118
LM	67047		LM67047	Inner	TS	118
LM	67047		LM67047	Inner	TSF	432
LM	67048		LM67048	Inner	2S	712
LM	67048		LM67048	Inner	TS	118
LM	67048		LM67048	Inner	TSF	432
LM	67048		LM67048	Inner	TSL	496
LM	67049	A	LM67049A	Inner	TS	118
	67320		67320	Outer	TS	318
	67320		67320	Outer	TS	322
Y1S-	67322		Y1S-67322	Spacer	2TS-DM	700
Y2S-	67322		Y2S-67322	Spacer	2TS-IM	674
	67322	-B	67322-B	Outer	TSF	480
	67322	D	67322D	Outer	TDO	548
	67322		67322	Outer	2TS-DM	700
	67322		67322	Outer	2TS-IM	674
	67322		67322	Outer	TDI	602
	67322		67322	Outer	TS	318

Prefix	Base	Suffix	Part Number Prefix + Base + Suffix	Part Type	Type	Page No.
	67322		67322	Outer	TS	322
	67325	D	67325D	Outer	TDO	548
X1S-	67388		X1S-67388	Spacer	2TS-IM	674
	67388	D	67388D	Inner	TDI	602
	67388		67388	Inner	2TS-DM	700
	67388		67388	Inner	2TS-IM	674
	67388		67388	Inner	TDO	548
	67388		67388	Inner	TS	318
	67389		67389	Inner	TDO	548
	67389		67389	Inner	TS	322
	67389		67389	Inner	TSF	480
	67390	D	67390D	Inner	TDI	602
	67390		67390	Inner	TDO	548
	67390		67390	Inner	TS	322
	67391		67391	Inner	TDO	548
	67391		67391	Inner	TS	322
	67425		67425	Inner	TS	310
	67434		67434	Inner	TS	312
	67437		67437	Inner	TS	312
	67675		67675	Outer	TS	310
	67675		67675	Outer	TS	312
Y1S-	67720		Y1S-67720	Spacer	2TS-DM	702
Y1S-	67720		Y1S-67720	Spacer	2TS-DM	704
Y3S-	67720		Y3S-67720	Spacer	2TS-DM	702
Y3S-	67720		Y3S-67720	Spacer	2TS-DM	704
Y9S-	67720		Y9S-67720	Spacer	2TS-IM	680
	67720	-B	67720-B	Outer	TSF	482
	67720	-B	67720-B	Outer	TSF	484
	67720	CD	67720CD	Outer	TDO	554
	67720	CD	67720CD	Outer	TDO	556
	67720		67720	Outer	2TS-DM	702
	67720		67720	Outer	2TS-DM	704
	67720		67720	Outer	2TS-IM	680
	67720		67720	Outer	TDI	604
	67720		67720	Outer	TS	332
	67720		67720	Outer	TS	334
	67720		67720	Outer	TS	336
	67780		67780	Inner	2TS-DM	702
	67780		67780	Inner	TDO	554
	67780		67780	Inner	TS	332
	67780		67780	Inner	TSF	482
	67782		67782	Inner	2TS-DM	702
	67782		67782	Inner	TDO	554
	67782		67782	Inner	TS	334
	67786		67786	Inner	2TS-DM	704
	67786		67786	Inner	TDO	556
	67786		67786	Inner	TS	336
	67787		67787	Inner	TDO	556
	67787		67787	Inner	TS	336
X6S-	67790		X6S-67790	Spacer	2TS-IM	680
	67790	D	67790D	Inner	TDI	604
	67790		67790	Inner	2TS-DM	704
	67790		67790	Inner	2TS-IM	680
	67790		67790	Inner	TDO	556
	67790		67790	Inner	TS	336
	67790		67790	Inner	TSF	484

Prefix	Base	Suffix	Part Number Prefix + Base + Suffix	Part Type	Type	Page No.
	67791		67791	Inner	TDO	556
	67791		67791	Inner	TS	336
	67820	-B	67820-B	Outer	TSF	484
	67820	CD	67820CD	Outer	TDO	556
	67820	CD	67820CD	Outer	TDO	558
	67820	CD	67820CD	Outer	TNASWE	656
	67820		67820	Outer	TS	340
	67820		67820	Outer	TS	342
	67835		67835	Outer	TS	340
	67883		67883	Inner	TDO	556
	67883		67883	Inner	TS	340
	67884		67884	Inner	TDO	556
	67884		67884	Inner	TS	340
NA	67885	SW	NA67885SW	Inner	TNASWE	656
	67885		67885	Inner	TDO	558
	67885		67885	Inner	TS	340
	67885		67885	Inner	TSF	484
	67886		67886	Inner	TS	340
	67887		67887	Inner	TDO	558
	67887		67887	Inner	TS	342
	67919		67919	Outer	TS	346
Y10S-	67920		Y10S-67920	Spacer	2TS-IM	682
	67920	-B	67920-B	Outer	TSF	484
	67920	CD	67920CD	Outer	TDO	558
	67920	CD	67920CD	Outer	TDO	560
	67920		67920	Outer	2TS-IM	682
	67920		67920	Outer	TDI	606
	67920		67920	Outer	TS	344
	67920		67920	Outer	TS	346
X2S-	67983		X2S-67983	Spacer	2TS-IM	682
	67983		67983	Inner	2TS-IM	682
	67983		67983	Inner	TDO	558
	67983		67983	Inner	TS	344
	67983		67983	Inner	TSF	484
	67985	D	67985D	Inner	TDI	606
	67985		67985	Inner	TDO	560
	67985		67985	Inner	TS	346
	67985		67985	Inner	TSF	484
	67989		67989	Inner	TDO	560
	67989		67989	Inner	TS	346
L	68110		L68110	Outer	TS	140
L	68111	EC	L68111EC	Spacer	2TS-IM	660
L	68111		L68111	Outer	2TS-IM	660
L	68111		L68111	Outer	TS	140
L	68149		L68149	Inner	2TS-IM	660
L	68149		L68149	Inner	TS	140
	68462		68462	Inner	TS	314
	68462		68462	Inner	TSF	478
	68463		68463	Inner	TS	314
	68709		68709	Outer	TS	314
	68712	-B	68712-B	Outer	TSF	478
	68712		68712	Outer	TS	314
JL	69310		JL69310	Outer	2TS-IM	660
JL	69310		JL69310	Outer	TS	146
JL	69348		JL69348	Inner	TS	146
JL	69349	A	JL69349A	Inner	TS	146

Prefix	Base	Suffix	Part Number Prefix + Base + Suffix	Part Type	Type	Page No.
JL	69349	X	JL69349X	Inner	TS	146
JL	69349		JL69349	Inner	2TS-IM	660
JL	69349		JL69349	Inner	TS	146
	69354		69354	Inner	TS	294
	69630		69630	Outer	TS	294
	71412		71412	Inner	TDO	544
	71412		71412	Inner	TS	308
	71412		71412	Inner	TSF	478
	71425		71425	Inner	TDO	544
	71425		71425	Inner	TS	310
	71425		71425	Inner	TSF	478
	71432		71432	Inner	TDO	544
	71432		71432	Inner	TS	310
	71437		71437	Inner	TDO	546
	71437		71437	Inner	TS	312
	71437		71437	Inner	TSF	478
NA	71450		NA71450	Inner	TNA	644
	71450	D	71450D	Inner	TDI	602
	71450		71450	Inner	TDO	546
	71450		71450	Inner	TS	312
	71450		71450	Inner	TSF	478
X2S-	71453		X2S-71453	Spacer	2TS-IM	674
	71453		71453	Inner	2TS-IM	674
	71453		71453	Inner	TDO	546
	71453		71453	Inner	TS	314
	71455		71455	Inner	TS	314
	71457	TD	71457TD	Inner	TDIT	630
	71750	-B	71750-B	Outer	TSF	478
	71750		71750	Outer	2TS-IM	674
	71750		71750	Outer	TDI	602
	71750		71750	Outer	TDIT	630
	71750		71750	Outer	TS	308
	71750		71750	Outer	TS	310
	71750		71750	Outer	TS	312
	71750		71750	Outer	TS	314
	71751	D	71751D	Outer	TDO	544
	71751	D	71751D	Outer	TDO	546
	71751	D	71751D	Outer	TNA	644
	72187	C	72187C	Inner	TS	196
	72188	C	72188C	Inner	TS	196
	72200	C	72200C	Inner	TS	210
	72201	C	72201C	Inner	TS	210
NA	72212		NA72212	Inner	TNA	640
	72212	C	72212C	Inner	TS	218
	72213	C	72213C	Inner	TS	218
	72218	C	72218C	Inner	TS	222
	72219	C	72219C	Inner	TS	222
	72225	C	72225C	Inner	TDO	520
	72225	C	72225C	Inner	TS	228
	72487		72487	Outer	TS	196
	72487		72487	Outer	TS	210
	72487		72487	Outer	TS	218
	72487		72487	Outer	TS	222
	72487		72487	Outer	TS	228
	72488	D	72488D	Outer	TDO	520
	72488	D	72488D	Outer	TNA	640

TAPERED ROLLER BEARINGS

INDEX

Prefix	Base	Suffix	Part Number Prefix + Base + Suffix	Part Type	Type	Page No.
	72500		72500	Outer	TS	218
LM	72810		LM72810	Outer	TS	96
LM	72849		LM72849	Inner	TS	96
	73551		73551	Inner	TDO	550
	73551		73551	Inner	TS	324
	73562		73562	Inner	TDO	552
	73562		73562	Inner	TS	326
	73875		73875	Outer	TS	324
	73875		73875	Outer	TS	326
	73876	CD	73876CD	Outer	TDO	550
	73876	CD	73876CD	Outer	TDO	552
	74472		74472	Inner	TDO	546
	74472		74472	Inner	TS	314
	74473	X	74473X	Inner	TS	316
	74500		74500	Inner	2TS-DM	700
	74500		74500	Inner	TDO	548
	74500		74500	Inner	TS	320
	74500		74500	Inner	TSF	480
	74510	D	74510D	Inner	TDI	602
	74512	D	74512D	Inner	TDI	602
X3S-	74525		X3S-74525	Spacer	2TS-IM	676
	74525		74525	Inner	2TS-DM	700
	74525		74525	Inner	2TS-IM	676
	74525		74525	Inner	TDO	548
	74525		74525	Inner	TS	322
	74525		74525	Inner	TS	324
	74525		74525	Inner	TSF	480
	74537		74537	Inner	TDO	550
	74537		74537	Inner	TS	324
	74537		74537	Inner	TSF	480
X11S-	74550		X11S-74550	Spacer	2TS-IM	676
	74550	A	74550A	Inner	TDO	550
	74550	A	74550A	Inner	TS	324
	74550		74550	Inner	2TS-DM	700
	74550		74550	Inner	2TS-IM	676
	74550		74550	Inner	TDO	550
	74550		74550	Inner	TS	324
	74550		74550	Inner	TSF	480
	74845		74845	Outer	2TS-DM	700
	74845		74845	Outer	TS	322
	74845		74845	Outer	TS	324
Y17S-	74850		Y17S-74850	Spacer	2TS-IM	676
Y4S-	74850		Y4S-74850	Spacer	2TS-DM	700
Y6S-	74850		Y6S-74850	Spacer	2TS-IM	676
	74850	-B	74850-B	Outer	TSF	480
	74850		74850	Outer	2TS-DM	700
	74850		74850	Outer	2TS-IM	676
	74850		74850	Outer	TDI	602
	74850		74850	Outer	TS	314
	74850		74850	Outer	TS	316
	74850		74850	Outer	TS	320
	74850		74850	Outer	TS	322
	74850		74850	Outer	TS	324
	74851	CD	74851CD	Outer	TDO	546
	74851	CD	74851CD	Outer	TDO	548
	74851	CD	74851CD	Outer	TDO	550

Prefix	Base	Suffix	Part Number Prefix + Base + Suffix	Part Type	Type	Page No.
	74853		74853	Outer	TS	324
	74856		74856	Outer	TS	324
K	75277		K75277	Spacer	2TS-DM	702
	77350		77350	Inner	TS	292
	77362		77362	Inner	TS	296
	77364		77364	Inner	TS	296
	77375		77375	Inner	TS	302
	77375		77375	Inner	TSF	474
	77376		77376	Inner	TS	302
	77675	-B	77675-B	Outer	TSF	474
	77675		77675	Outer	TS	292
	77675		77675	Outer	TS	296
	77675		77675	Outer	TS	302
	77676	X	77676X	Outer	TS	302
	78214	C	78214C	Inner	TS	220
	78215	C	78215C	Inner	TDO	518
	78215	C	78215C	Inner	TS	218
	78215	C	78215C	Inner	TS	220
	78225	C	78225C	Inner	TS	228
	78225	C	78225C	Inner	TS	230
	78225		78225	Inner	TDO	520
	78225		78225	Inner	TS	230
	78238	C	78238C	Inner	TS	236
	78248	C	78248C	Inner	TS	244
NA	78250		NA78250	Inner	TNA	640
	78250		78250	Inner	2TS-DM	690
	78250		78250	Inner	TDO	524
	78250		78250	Inner	TS	244
	78250		78250	Inner	TS	246
	78251	D	78251D	Inner	TDI	600
	78255	D	78255D	Inner	TDI	600
	78255	X	78255X	Inner	TDO	524
	78255	X	78255X	Inner	TS	246
LM	78310	A	LM78310A	Outer	TS	140
LM	78310	C	LM78310C	Outer	TS	140
LM	78349	A	LM78349A	Inner	TS	140
LM	78349		LM78349	Inner	TS	140
	78537		78537	Outer	TDI	600
	78537		78537	Outer	TS	218
	78537		78537	Outer	TS	228
	78537		78537	Outer	TS	236
	78537		78537	Outer	TS	244
	78549	D	78549D	Outer	TDO	518
	78549	D	78549D	Outer	TDO	520
	78549	D	78549D	Outer	TDO	524
	78549	D	78549D	Outer	TNA	640
Y2S-	78551		Y2S-78551	Spacer	2TS-DM	690
	78551		78551	Outer	2TS-DM	690
	78551		78551	Outer	TDI	600
	78551		78551	Outer	TS	220
	78551		78551	Outer	TS	230
	78551		78551	Outer	TS	236
	78551		78551	Outer	TS	246
	78571		78571	Outer	TS	246
	80170		80170	Inner	TS	382
	80176		80176	Inner	TS	382

Prefix	Base	Suffix	Part Number Prefix + Base + Suffix	Part Type	Type	Page No.
	80180		80180	Inner	TS	382
	80217		80217	Outer	TS	382
	80222		80222	Outer	TS	382
	80325	-B	80325-B	Outer	TSF	490
	80325		80325	Outer	TS	380
	80385		80385	Inner	TS	380
	80385		80385	Inner	TSF	490
	80418		80418	Outer	TS	386
Y3S-	80425		Y3S-80425	Spacer	2TS-DM	710
	80425		80425	Outer	2TS-DM	710
	80425		80425	Outer	2TS-IM	686
	80425		80425	Outer	TS	384
X3S-	80480		X3S-80480	Spacer	2TS-IM	686
	80480		80480	Inner	2TS-DM	710
	80480		80480	Inner	2TS-IM	686
	80480		80480	Inner	TS	384
	80487		80487	Inner	TS	386
K	80686		K80686	Spacer	2TS-DM	708
	80720		80720	Outer	TS	390
	80780		80780	Inner	TS	390
	81575		81575	Inner	TDO	552
	81575		81575	Inner	TS	328
	81590		81590	Inner	TDO	552
	81590		81590	Inner	TS	330
	81593		81593	Inner	TDO	552
	81593		81593	Inner	TS	330
	81600		81600	Inner	TDO	552
	81600		81600	Inner	TS	330
	81601	D	81601D	Inner	TDI	604
	81606		81606	Inner	TDO	554
HM	81610		HM81610	Outer	TS	90
	81629		81629	Inner	TDO	554
	81629		81629	Inner	TS	332
	81630		81630	Inner	TDO	554
	81630		81630	Inner	TS	332
HM	81649		HM81649	Inner	TS	90
	81962		81962	Outer	TDI	604
	81962		81962	Outer	TS	328
	81962		81962	Outer	TS	330
	81962		81962	Outer	TS	332
	81963	CD	81963CD	Outer	TDO	552
	81963	CD	81963CD	Outer	TDO	554
	81964		81964	Outer	TS	330
	82550		82550	Inner	TDO	550
	82562	A	82562A	Inner	TS	326
	82562		82562	Inner	TDO	552
NA	82576		NA82576	Inner	TNA	644
	82576		82576	Inner	TDO	552
	82576		82576	Inner	TS	328
	82576		82576	Inner	TSF	482
NA	82587		NA82587	Inner	TNA	644
	82587	D	82587D	Inner	TDI	604
	82587		82587	Inner	TDO	552
Y2S-	82620		Y2S-82620	Spacer	2TS-DM	704
	82620		82620	Outer	2TS-DM	704
	82620		82620	Outer	TDI	604

Prefix	Base	Suffix	Part Number Prefix + Base + Suffix	Part Type	Type	Page No.
	82680	D	82680D	Inner	TDI	604
	82680	X	82680X	Inner	2TS-DM	704
	82720		82720	Outer	TS	340
	82722		82722	Outer	TS	340
	82788		82788	Inner	TS	340
	82931		82931	Outer	TDI	604
	82931		82931	Outer	TS	326
	82931		82931	Outer	TS	328
	82932	D	82932D	Outer	TNA	644
	82950	-B	82950-B	Outer	TSF	482
	82950		82950	Outer	TDI	604
	82950		82950	Outer	TS	326
	82950		82950	Outer	TS	328
	82951	CD	82951CD	Outer	TDO	550
	82951	CD	82951CD	Outer	TDO	552
	84115		84115	Inner	TS	366
	84155		84155	Outer	TS	366
M	84210		M84210	Outer	TS	102
K	84215		K84215	Spacer	2TS-IM	672
K	84216		K84216	Spacer	2TS-IM	672
K	84217		K84217	Spacer	2TS-IM	672
M	84249		M84249	Inner	TS	102
M	84510		M84510	Outer	TS	100
M	84510		M84510	Outer	TS	106
M	84548		M84548	Inner	TS	100
M	84549		M84549	Inner	TS	106
K	85370		K85370	Spacer	2TS-DM	708
K	85372		K85372	Spacer	2TS-IM	666
Y2S-	86100		Y2S-86100	Spacer	2TS-DM	704
	86100	-B	86100-B	Outer	TSF	482
	86100		86100	Outer	2TS-DM	704
	86100		86100	Outer	TS	332
	86100		86100	Outer	TS	334
M	86610		M86610	Outer	TS	108
M	86610		M86610	Outer	TS	114
M	86610		M86610	Outer	TS	118
M	86611	-B	M86611-B	Outer	TSF	430
M	86647		M86647	Inner	TS	108
M	86648	A	M86648A	Inner	TS	118
M	86649		M86649	Inner	TS	114
M	86649		M86649	Inner	TSF	430
	86650		86650	Inner	TS	332
	86650		86650	Inner	TSF	482
	86669		86669	Inner	2TS-DM	704
	86669		86669	Inner	TS	334
	87111	-B	87111-B	Outer	TSF	484
	87111		87111	Outer	TS	340
	87111		87111	Outer	TS	342
	87112	D	87112D	Outer	TNA	644
	87112	D	87112D	Outer	TNASWE	654
NA	87700	SW	NA87700SW	Inner	TNASWE	654
NA	87700		NA87700	Inner	TNA	644
	87737		87737	Inner	TS	340
	87750		87750	Inner	TS	340
	87762		87762	Inner	TS	342
	87762		87762	Inner	TSF	484

TAPERED ROLLER BEARINGS

INDEX

Prefix	Base	Suffix	Part Number Prefix + Base + Suffix	Part Type	Type	Page No.
M	88010		M88010	Outer	2TS-IM	660
M	88010		M88010	Outer	2S	712
M	88010		M88010	Outer	TS	104
M	88010		M88010	Outer	TS	120
M	88010		M88010	Outer	TS	126
M	88012		M88012	Outer	TS	126
M	88022		M88022	Outer	TS	128
M	88036		M88036	Inner	TS	104
M	88040	A	M88040A	Inner	2TS-IM	660
M	88040	XA	M88040XA	Spacer	2TS-IM	660
M	88046		M88046	Inner	TS	120
M	88048	A	M88048A	Inner	TS	126
M	88048	-S	M88048-S	Inner	TS	126
M	88048		M88048	Inner	2S	712
M	88048		M88048	Inner	TS	126
M	88048		M88048	Inner	TS	128
Y1S-	88126		Y1S-88126	Spacer	2TS-DM	708
	88126		88126	Outer	2TS-DM	708
	88126		88126	Outer	TS	350
	88126		88126	Outer	TS	352
	88126		88126	Outer	TS	354
	88128		88128	Outer	TS	350
	88128		88128	Outer	TS	352
	88129	-B	88129-B	Outer	TSF	486
HM	88510		HM88510	Outer	TS	124
HM	88510		HM88510	Outer	TS	128
HM	88511		HM88511	Outer	TS	128
HM	88512		HM88512	Outer	TS	128
JHM	88513		JHM88513	Outer	2TS-IM	660
JHM	88513		JHM88513	Outer	TS	114
JHM	88540		JHM88540	Inner	2TS-IM	660
JHM	88540		JHM88540	Inner	TS	114
HM	88542		HM88542	Inner	TS	124
HM	88547		HM88547	Inner	TS	128
HM	88610	A	HM88610A	Outer	TS	104
HM	88610		HM88610	Outer	2TS-IM	660
HM	88610		HM88610	Outer	2S	712
HM	88610		HM88610	Outer	TS	104
HM	88610		HM88610	Outer	TS	122
HM	88610		HM88610	Outer	TS	132
HM	88610		HM88610	Outer	TS	142
HM	88611	AS	HM88611AS	Outer	TS	122
HM	88611	AS	HM88611AS	Outer	TS	132
HM	88611		HM88611	Outer	TS	124
HM	88611		HM88611	Outer	TS	132
HM	88612		HM88612	Outer	TS	104
HM	88630		HM88630	Inner	TS	104
HM	88638		HM88638	Inner	TS	124
HM	88644		HM88644	Inner	TS	122
HM	88648		HM88648	Inner	TS	142
HM	88649	A	HM88649A	Inner	TS	132
HM	88649	XB	HM88649XB	Spacer	2TS-IM	660
HM	88649		HM88649	Inner	2TS-IM	660
HM	88649		HM88649	Inner	2S	712
HM	88649		HM88649	Inner	TS	132
	88900		88900	Inner	2TS-DM	708

Prefix	Base	Suffix	Part Number Prefix + Base + Suffix	Part Type	Type	Page No.
	88900		88900	Inner	TS	350
	88925		88925	Inner	TS	352
	88925		88925	Inner	TSF	486
	88931	H	88931H	Inner	TS	354
	88931		88931	Inner	TS	354
	89108	D	89108D	Inner	TDI	612
	89111	D	89111D	Inner	TDI	612
	89148		89148	Outer	TDI	612
	89150		89150	Outer	TDI	612
HM	89210		HM89210	Outer	TS	144
HM	89249		HM89249	Inner	TS	144
HM	89410	-B	HM89410-B	Outer	TSF	434
HM	89410	-B	HM89410-B	Outer	TSF	436
HM	89410	-B	HM89410-B	Outer	TSF	438
HM	89410		HM89410	Outer	TS	124
HM	89410		HM89410	Outer	TS	130
HM	89410		HM89410	Outer	TS	136
HM	89410		HM89410	Outer	TS	144
HM	89411		HM89411	Outer	TS	130
HM	89411		HM89411	Outer	TS	144
HM	89440		HM89440	Inner	TS	124
HM	89443		HM89443	Inner	TS	130
HM	89443		HM89443	Inner	TSF	434
HM	89444		HM89444	Inner	TS	130
HM	89446	A	HM89446A	Inner	TS	136
HM	89446		HM89446	Inner	TS	136
HM	89446		HM89446	Inner	TSF	436
HM	89448		HM89448	Inner	TS	144
HM	89448		HM89448	Inner	TSF	438
HM	89449		HM89449	Inner	TS	144
HM	89449		HM89449	Inner	TSF	438
NP	89744		NP089744	Outer	2TS-DM	710
X1S-	90334		X1S-90334	Spacer	2TS-IM	670
	90334		90334	Inner	2TS-IM	670
	90334		90334	Inner	TS	286
J	90354		J90354	Inner	2TS-DM	696
J	90354		J90354	Inner	TS	294
X1S-	90381		X1S-90381	Spacer	2TS-IM	670
X4S-	90381		X4S-90381	Spacer	2TS-IM	670
	90381		90381	Inner	2TS-DM	696
	90381		90381	Inner	2TS-IM	670
	90381		90381	Inner	TS	302
Y1S-	90744		Y1S-90744	Spacer	2TS-IM	670
Y2S-	90744		Y2S-90744	Spacer	2TS-DM	696
Y4S-	90744		Y4S-90744	Spacer	2TS-IM	670
	90744		90744	Outer	2TS-DM	696
	90744		90744	Outer	2TS-IM	670
	90744		90744	Outer	TS	286
	90744		90744	Outer	TS	302
J	90748		J90748	Outer	2TS-DM	696
J	90748		J90748	Outer	TS	294
Y1S-	90748		Y1S-90748	Spacer	2TS-DM	696
Y14S-	93125		Y14S-93125	Spacer	2TS-IM	682
Y6S-	93125		Y6S-93125	Spacer	2TS-DM	706
	93125	-B	93125-B	Outer	TSF	484
	93125		93125	Outer	2TS-DM	706

Prefix	Base	Suffix	Part Number Prefix + Base + Suffix	Part Type	Type	Page No.
	93125		93125	Outer	2TS-IM	682
	93125		93125	Outer	TDI	604
	93125		93125	Outer	TDI	606
	93125		93125	Outer	TDIT	630
	93125		93125	Outer	TS	338
	93125		93125	Outer	TS	340
	93125		93125	Outer	TS	342
	93125		93125	Outer	TS	344
	93125		93125	Outer	TS	346
	93126		93126	Outer	TDI	606
	93126		93126	Outer	TS	342
	93126		93126	Outer	TS	346
	93127	CD	93127CD	Outer	TDO	556
	93127	CD	93127CD	Outer	TDO	558
	93127	CD	93127CD	Outer	TDO	560
	93128	XD	93128XD	Outer	TDO	560
J	93129	A	J93129A	Outer	TS	342
	93708		93708	Inner	TDO	556
	93708		93708	Inner	TS	338
	93708		93708	Inner	TSF	484
	93750		93750	Inner	TDO	558
	93750		93750	Inner	TS	340
	93750		93750	Inner	TSF	484
	93751	D	93751D	Inner	TDI	604
	93775		93775	Inner	TDO	558
	93775		93775	Inner	TS	342
	93787		93787	Inner	TDO	558
	93787		93787	Inner	TS	342
	93787		93787	Inner	TSF	484
	93788	D	93788D	Inner	TDI	606
X4S-	93800		X4S-93800	Spacer	2TS-IM	682
	93800	A	93800A	Inner	TS	344
	93800	D	93800D	Inner	TDI	606
	93800		93800	Inner	2TS-IM	682
	93800		93800	Inner	TDO	560
	93800		93800	Inner	TS	344
	93800		93800	Inner	TSF	484
	93801	D	93801D	Inner	TDI	606
	93806	A	93806A	Inner	TS	346
	93812		93812	Inner	TS	346
X1S-	93825		X1S-93825	Spacer	2TS-IM	682
	93825	A	93825A	Inner	TDO	560
	93825	A	93825A	Inner	TS	346
	93825		93825	Inner	2TS-DM	706
	93825		93825	Inner	2TS-IM	682
	93825		93825	Inner	TDO	560
	93825		93825	Inner	TS	346
	93825		93825	Inner	TSF	484
	93826	TD	93826TD	Inner	TDIT	630
Y11S-	94113		Y11S-94113	Spacer	2TS-DM	702
Y20S-	94113		Y20S-94113	Spacer	2TS-IM	680
	94113	-B	94113-B	Outer	TSF	484
	94113		94113	Outer	2TS-DM	702
	94113		94113	Outer	2TS-IM	680
	94113		94113	Outer	TDI	604
	94113		94113	Outer	TS	334

Prefix	Base	Suffix	Part Number Prefix + Base + Suffix	Part Type	Type	Page No.
	94113		94113	Outer	TS	336
	94114	CD	94114CD	Outer	TDO	554
	94114	CD	94114CD	Outer	TDO	556
	94117	D	94117D	Outer	TNA	644
	94118	D	94118D	Outer	TNA	644
	94118	D	94118D	Outer	TNA	646
	94118		94118	Outer	TS	336
	94649		94649	Inner	2TS-DM	702
	94649		94649	Inner	TDO	554
	94649		94649	Inner	TS	334
NA	94650		NA94650	Inner	TNA	644
	94675		94675	Inner	TDO	556
	94687		94687	Inner	TDO	556
	94687		94687	Inner	TS	336
	94687		94687	Inner	TSF	484
NA	94700		NA94700	Inner	TNA	644
NA	94700		NA94700	Inner	TNA	646
X13S-	94700		X13S-94700	Spacer	2TS-IM	680
	94700		94700	Inner	2TS-IM	680
	94700		94700	Inner	TDO	556
	94700		94700	Inner	TS	336
	94700		94700	Inner	TSF	484
	94706	D	94706D	Inner	TDI	604
X4S-	95475		X4S-95475	Spacer	2TS-IM	674
	95475		95475	Inner	2TS-DM	698
	95475		95475	Inner	2TS-IM	674
	95475		95475	Inner	TDO	546
	95475		95475	Inner	TS	318
	95475		95475	Inner	TSF	480
	95491		95491	Inner	TDO	546
	95491		95491	Inner	TS	318
	95499	D	95499D	Inner	TDI	602
	95500		95500	Inner	2TS-DM	700
	95500		95500	Inner	TDO	548
	95500		95500	Inner	TS	320
	95500		95500	Inner	TSF	480
	95512	X	95512X	Inner	TS	322
	95512		95512	Inner	TS	320
	95525		95525	Inner	2TS-IM	676
	95525		95525	Inner	TDO	550
	95525		95525	Inner	TS	324
	95525		95525	Inner	TSF	480
	95528		95528	Inner	TDO	550
	95528		95528	Inner	TS	324
	95905		95905	Outer	TS	322
Y1S-	95925		Y1S-95925	Spacer	2TS-DM	698
Y1S-	95925		Y1S-95925	Spacer	2TS-DM	700
	95925	-B	95925-B	Outer	TSF	480
	95925		95925	Outer	2TS-DM	698
	95925		95925	Outer	2TS-DM	700
	95925		95925	Outer	2TS-IM	674
	95925		95925	Outer	2TS-IM	676
	95925		95925	Outer	TDI	602
	95925		95925	Outer	TS	318
	95925		95925	Outer	TS	320
	95925		95925	Outer	TS	322

TAPERED ROLLER BEARINGS

INDEX

Prefix	Base	Suffix	Part Number Prefix + Base + Suffix	Part Type	Type	Page No.
	95925		95925	Outer	TS	324
	95927	CD	95927CD	Outer	TDO	546
	95927	CD	95927CD	Outer	TDO	548
	95927	CD	95927CD	Outer	TDO	550
	95928		95928	Outer	TS	322
	95929		95929	Outer	TS	320
	95962		95962	Outer	TS	320
Y5S-	96140		Y5S-96140	Spacer	2TS-DM	708
Y7S-	96140		Y7S-96140	Spacer	2TS-DM	706
Y9S-	96140		Y9S-96140	Spacer	2TS-IM	682
	96140	-B	96140-B	Outer	TSF	486
	96140	CD	96140CD	Outer	TDO	560
	96140	CD	96140CD	Outer	TDO	562
	96140	CD	96140CD	Outer	TDO	564
	96140		96140	Outer	2TS-DM	706
	96140		96140	Outer	2TS-DM	708
	96140		96140	Outer	2TS-IM	682
	96140		96140	Outer	TDI	606
	96140		96140	Outer	TS	346
	96140		96140	Outer	TS	350
	96140		96140	Outer	TS	352
	96825		96825	Inner	2TS-DM	706
	96825		96825	Inner	TDO	560
	96825		96825	Inner	TS	346
	96851	D	96851D	Inner	TDI	606
X6S-	96900		X6S-96900	Spacer	2TS-IM	682
	96900		96900	Inner	2TS-DM	708
	96900		96900	Inner	2TS-IM	682
	96900		96900	Inner	TDO	562
	96900		96900	Inner	TS	350
	96900		96900	Inner	TSF	486
	96925		96925	Inner	TDO	564
	96925		96925	Inner	TS	352
NA	97450		NA97450	Inner	TNA	644
	97472	X	97472X	Inner	TS	316
	97500	D	97500D	Inner	TDI	602
	97500		97500	Inner	TS	320
	97900		97900	Outer	TDI	602
	97900		97900	Outer	TS	320
	97901	D	97901D	Outer	TNA	644
	97905	X	97905X	Outer	TS	316
	98316		98316	Inner	TDO	532
	98316		98316	Inner	TS	280
	98335		98335	Inner	TDO	534
	98335		98335	Inner	TS	288
NA	98350		NA98350	Inner	TNA	642
	98350		98350	Inner	2TS-DM	694
	98350		98350	Inner	TDO	536
	98350		98350	Inner	TS	292
	98350		98350	Inner	TSF	472
	98394	X	98394X	Inner	TDO	540
	98394	X	98394X	Inner	TS	304
	98400		98400	Inner	TDO	542
	98400		98400	Inner	TS	308
	98400		98400	Inner	TSF	476
Y3S-	98788		Y3S-98788	Spacer	2TS-DM	694

Prefix	Base	Suffix	Part Number Prefix + Base + Suffix	Part Type	Type	Page No.
	98788	-B	98788-B	Outer	TSF	472
	98788	-B	98788-B	Outer	TSF	476
	98788		98788	Outer	2TS-DM	694
	98788		98788	Outer	TS	280
	98788		98788	Outer	TS	288
	98788		98788	Outer	TS	292
	98788		98788	Outer	TS	304
	98788		98788	Outer	TS	308
	98789	D	98789D	Outer	TDO	532
	98789	D	98789D	Outer	TDO	534
	98789	D	98789D	Outer	TDO	536
	98789	D	98789D	Outer	TDO	540
	98789	D	98789D	Outer	TDO	542
	98789	D	98789D	Outer	TNA	642
	99097		99097	Outer	TS	330
	99098	X	99098X	Outer	TS	330
Y1S-	99100		Y1S-99100	Spacer	2TS-DM	700
Y1S-	99100		Y1S-99100	Spacer	2TS-DM	702
	99100	-B	99100-B	Outer	TSF	480
	99100	-B	99100-B	Outer	TSF	482
	99100		99100	Outer	2TS-DM	700
	99100		99100	Outer	2TS-DM	702
	99100		99100	Outer	TDI	604
	99100		99100	Outer	TS	320
	99100		99100	Outer	TS	326
	99100		99100	Outer	TS	328
	99100		99100	Outer	TS	330
	99102	CD	99102CD	Outer	TDO	550
	99102	CD	99102CD	Outer	TDO	552
NP	99132		NP099132	Outer	TDO	562
	99500		99500	Inner	TS	320
	99537		99537	Inner	TDO	550
	99537		99537	Inner	TSF	480
	99550		99550	Inner	2TS-DM	700
	99550		99550	Inner	TDO	550
	99550		99550	Inner	TS	326
	99550		99550	Inner	TSF	480
	99575		99575	Inner	TDO	552
	99575		99575	Inner	TS	328
	99575		99575	Inner	TSF	482
	99587	D	99587D	Inner	TDI	604
	99587		99587	Inner	TDO	552
	99587		99587	Inner	TS	328
	99587		99587	Inner	TSF	482
X7S-	99600		X7S-99600	Spacer	2TS-IM	678
	99600		99600	Inner	2TS-DM	702
	99600		99600	Inner	TDO	552
	99600		99600	Inner	TS	330
	99600		99600	Inner	TSF	482
EE	101103		EE101103	Inner	TDO	572
EE	101103		EE101103	Inner	TS	364
	101575		101575	Outer	TS	364
	101600		101600	Outer	TS	364
	101601	CD	101601CD	Outer	TDO	572
L	102810	-B	L102810-B	Outer	TSF	448
L	102810		L102810	Outer	TS	172

Prefix	Base	Suffix	Part Number Prefix + Base + Suffix	Part Type	Type	Page No.
L	102849		L102849	Inner	TS	172
L	102849		L102849	Inner	TSF	448
LM	102910		LM102910	Outer	TS	188
LM	102911		LM102911	Outer	TS	188
LM	102949	XB	LM102949XB	Spacer	2S	714
LM	102949		LM102949	Inner	TS	188
NP	102973		NP102973	Outer	TDI	622
LL	103010	-B	LL103010-B	Outer	TSF	448
LL	103010		LL103010	Outer	TS	172
LL	103049		LL103049	Inner	TS	172
LL	103049		LL103049	Inner	TSF	448
JLM	104910		JLM104910	Outer	2TS-IM	662
JLM	104910		JLM104910	Outer	SR	716
JLM	104910		JLM104910	Outer	TS	198
JLM	104910		JLM104910	Outer	TS	200
LM	104910	ES	LM104910ES	Spacer	2TS-IM	662
LM	104910	ES	LM104910ES	Spacer	SR	716
LM	104911	A	LM104911A	Outer	TS	198
LM	104911	A	LM104911A	Outer	TS	200
LM	104911	EA	LM104911EA	Spacer	2TS-IM	662
LM	104911		LM104911	Outer	2TS-IM	662
LM	104911		LM104911	Outer	TS	198
LM	104911		LM104911	Outer	TS	200
LM	104912		LM104912	Outer	TS	198
LM	104912		LM104912	Outer	TS	200
JLM	104914		JLM104914	Outer	TS	196
JLM	104942	A	JLM104942A	Inner	TS	196
LM	104947	A	LM104947A	Inner	TS	198
JLM	104948		JLM104948	Inner	2TS-IM	662
JLM	104948		JLM104948	Inner	SR	716
JLM	104948		JLM104948	Inner	TS	198
LM	104948	XB	LM104948XB	Spacer	2TS-IM	662
LM	104948	XS	LM104948XS	Spacer	SR	716
LM	104949	E	LM104949E	Inner	2TS-IM	662
LM	104949		LM104949	Inner	TS	200
K	106389	R	K106389R	Spacer	2S	712
K	106390	R	K106390R	Spacer	2S	712
K	106393	R	K106393R	Spacer	2S	712
K	106397	R	K106397R	Spacer	2S	712
K	106398	R	K106398R	Spacer	2S	712
K	106610	R	K106610R	Spacer	2S	712
K	106789	R	K106789R	Spacer	2S	712
K	106790	R	K106790R	Spacer	2S	712
K	106817	R	K106817R	Spacer	2S	712
EE	107057		EE107057	Inner	2TS-DM	702
EE	107057		EE107057	Inner	TS	328
EE	107060		EE107060	Inner	2TS-IM	678
EE	107060		EE107060	Inner	TDO	554
EE	107060		EE107060	Inner	TS	330
K	107061	R	K107061R	Spacer	2S	712
K	107087	R	K107087R	Spacer	2S	712
Y2S-	107105		Y2S-107105	Spacer	2TS-DM	702
	107105	CD	107105CD	Outer	TDO	554
	107105		107105	Outer	2TS-DM	702
	107105		107105	Outer	2TS-IM	676
	107105		107105	Outer	2TS-IM	678

Prefix	Base	Suffix	Part Number Prefix + Base + Suffix	Part Type	Type	Page No.
	107105		107105	Outer	TS	328
	107105		107105	Outer	TS	330
K	107577	R	K107577R	Spacer	2S	714
K	107578	R	K107578R	Spacer	2S	714
K	107581	R	K107581R	Spacer	2S	714
K	107582	R	K107582R	Spacer	2S	714
EE	108065		EE108065	Inner	TS	334
	108142		108142	Outer	TS	334
EE	109120		EE109120	Inner	TDO	574
K	109151	R	K109151R	Spacer	2S	714
K	109152	R	K109152R	Spacer	2TS-IM	662
K	109152	R	K109152R	Spacer	2S	714
	109161	D	109161D	Outer	TDO	574
	109163	D	109163D	Outer	TDO	574
K	109519	R	K109519R	Spacer	2S	712
EE	111175		EE111175	Inner	TS	368
	111700		111700	Outer	TS	368
EE	113089		EE113089	Inner	2TS-DM	706
EE	113089		EE113089	Inner	TDO	562
EE	113089		EE113089	Inner	TS	348
EE	113090	D	EE113090D	Inner	TDI	608
EE	113091		EE113091	Inner	2TS-DM	706
EE	113091		EE113091	Inner	TDO	562
EE	113091		EE113091	Inner	TS	350
Y2S-	113170		Y2S-113170	Spacer	2TS-DM	706
Y4S-	113170		Y4S-113170	Spacer	2TS-DM	706
	113170		113170	Outer	2TS-DM	706
	113170		113170	Outer	TDI	608
	113170		113170	Outer	TS	348
	113170		113170	Outer	TS	350
	113171	D	113171D	Outer	TDO	562
EE	114080		EE114080	Inner	2TS-DM	706
EE	114080		EE114080	Inner	TS	344
EE	114081		EE114081	Inner	TDO	560
EE	114081		EE114081	Inner	TS	344
Y2S-	114160		Y2S-114160	Spacer	2TS-DM	706
	114160		114160	Outer	2TS-DM	706
	114160		114160	Outer	TS	344
	114161	D	114161D	Outer	TDO	560
K	114294	R	K114294R	Spacer	2S	714
K	114295	R	K114295R	Spacer	2S	714
EE	116050		EE116050	Inner	TS	320
	116098		116098	Outer	TS	320
L	116110	-B	L116110-B	Outer	TSF	470
L	116110	D	L116110D	Outer	TDO	532
L	116110		L116110	Outer	TS	280
L	116149		L116149	Inner	TDO	532
L	116149		L116149	Inner	TS	280
L	116149		L116149	Inner	TSF	470
LL	116210		LL116210	Outer	TS	280
LL	116249		LL116249	Inner	TS	280
EE	117063		EE117063	Inner	2TS-DM	702
EE	117067		EE117067	Inner	2TS-DM	704
Y3S-	117148		Y3S-117148	Spacer	2TS-DM	702
Y3S-	117148		Y3S-117148	Spacer	2TS-DM	704
	117148		117148	Outer	2TS-DM	702

TAPERED ROLLER BEARINGS

INDEX

Prefix	Base	Suffix	Part Number Prefix + Base + Suffix	Part Type	Type	Page No.
	117148		117148	Outer	2TS-DM	704
NP	118297		NP118297	Inner	2S	714
LM	119311	D	LM119311D	Outer	TDO	538
LM	119311		LM119311	Outer	TDI	602
LM	119311		LM119311	Outer	TS	298
LM	119348	D	LM119348D	Inner	TDI	602
LM	119348		LM119348	Inner	TDO	538
LM	119348		LM119348	Inner	TS	298
HM	120817	XD	HM120817XD	Outer	TDO	542
HM	120848		HM120848	Inner	TDO	542
EE	121140		EE121140	Inner	TS	374
	121265		121265	Outer	TS	374
LM	121310		LM121310	Outer	TS	308
LM	121349		LM121349	Inner	TS	308
DX	121944		DX121944	Thrust	TTHDFL	728
EE	125094		EE125094	Inner	TS	354
EE	125095		EE125095	Inner	TS	354
EE	125095		EE125095	Inner	TSF	486
	125145	-B	125145-B	Outer	TSF	486
	125145		125145	Outer	TS	354
LM	125711		LM125711	Outer	TS	318
LM	125748		LM125748	Inner	TS	318
EE	126097		EE126097	Inner	TDO	566
EE	126097		EE126097	Inner	TS	356
EE	126097		EE126097	Inner	TSF	486
EE	126098		EE126098	Inner	TDO	566
EE	126098		EE126098	Inner	TS	358
	126149	D	126149D	Outer	TDO	566
	126150	-B	126150-B	Outer	TSF	486
	126150		126150	Outer	TS	356
	126150		126150	Outer	TS	358
	126151	CD	126151CD	Outer	TDO	566
EE	127094	D	EE127094D	Inner	TDI	608
EE	127095		EE127095	Inner	TDO	564
EE	127095		EE127095	Inner	TDO	566
EE	127095		EE127095	Inner	TS	354
NA	127096	SW	NA127096SW	Inner	TNASWE	656
EE	127097	D	EE127097D	Inner	TDI	608
	127135		127135	Outer	TDI	608
	127135		127135	Outer	TS	354
	127136	CD	127136CD	Outer	TDO	564
	127136	CD	127136CD	Outer	TNASWE	656
	127137	D	127137D	Outer	TDO	564
	127138		127138	Outer	TDI	608
	127138		127138	Outer	TS	354
	127139	D	127139D	Outer	TDO	566
	127140		127140	Outer	TDI	608
	127140		127140	Outer	TS	354
EE	128102		EE128102	Inner	TS	360
EE	128110		EE128110	Inner	TDO	572
EE	128110		EE128110	Inner	TS	366
EE	128110		EE128110	Inner	TSF	488
EE	128111		EE128111	Inner	TS	364
EE	128111		EE128111	Inner	TS	366
EE	128111		EE128111	Inner	TSF	488
EE	128112		EE128112	Inner	TS	364

Prefix	Base	Suffix	Part Number Prefix + Base + Suffix	Part Type	Type	Page No.
EE	128113	TD	EE128113TD	Inner	TDIT	630
EE	128114	D	EE128114D	Inner	TDI	612
EE	128114		EE128114	Inner	TSF	488
	128160	-B	128160-B	Outer	TSF	488
	128160	CD	128160CD	Outer	TDO	572
	128160		128160	Outer	TS	360
	128160		128160	Outer	TS	364
	128160		128160	Outer	TS	366
	128161		128161	Outer	TDI	612
	128161		128161	Outer	TDIT	630
	128161		128161	Outer	TS	366
EE	129119	D	EE129119D	Inner	TDI	614
EE	129120	X	EE129120X	Inner	TDO	574
EE	129120	X	EE129120X	Inner	TS	368
EE	129121	D	EE129121D	Inner	TDI	614
EE	129123	D	EE129123D	Inner	TDI	616
EE	129124	D	EE129124D	Inner	TDI	614
	129172		129172	Outer	TDI	614
	129172		129172	Outer	TDI	616
	129172		129172	Outer	TS	368
	129173	CD	129173CD	Outer	TDO	574
	129174		129174	Outer	TDI	614
EE	130787		EE130787	Inner	TS	342
EE	130850	D	EE130850D	Inner	TDI	606
EE	130851		EE130851	Inner	TDO	562
EE	130851		EE130851	Inner	TS	348
EE	130887	D	EE130887D	Inner	TDI	606
EE	130888	D	EE130888D	Inner	TDI	606
EE	130889		EE130889	Inner	TDO	562
EE	130889		EE130889	Inner	TS	348
EE	130900	D	EE130900D	Inner	TDI	608
EE	130902		EE130902	Inner	TDO	564
EE	130902		EE130902	Inner	TS	350
EE	130903	D	EE130903D	Inner	TDI	608
EE	130926	TD	EE130926TD	Inner	TDIT	630
EE	130927	TD	EE130927TD	Inner	TDIT	630
	131400		131400	Outer	TDI	606
	131400		131400	Outer	TDI	608
	131400		131400	Outer	TDIT	630
	131400		131400	Outer	TS	342
	131400		131400	Outer	TS	348
	131400		131400	Outer	TS	350
	131401	CD	131401CD	Outer	TDO	562
	131401	CD	131401CD	Outer	TDO	564
	131402	D	131402D	Outer	TDO	562
	131402	D	131402D	Outer	TDO	564
EE	132083		EE132083	Inner	TS	344
NA	132083		NA132083	Inner	TNA	646
EE	132084		EE132084	Inner	TDO	560
EE	132084		EE132084	Inner	TS	346
	132125		132125	Outer	TS	344
	132125		132125	Outer	TS	346
	132126	D	132126D	Outer	TDO	560
	132126	D	132126D	Outer	TNA	646
EE	133136	D	EE133136D	Inner	TDI	616
	133180		133180	Outer	TDI	616

Prefix	Base	Suffix	Part Number Prefix + Base + Suffix	Part Type	Type	Page No.
EE	134100		EE134100	Inner	TDO	568
EE	134100		EE134100	Inner	TS	358
EE	134102	D	EE134102D	Inner	TDI	610
EE	134102		EE134102	Inner	TDO	568
EE	134102		EE134102	Inner	TS	360
	134143		134143	Outer	TDI	610
	134143		134143	Outer	TS	358
	134143		134143	Outer	TS	360
	134144	CD	134144CD	Outer	TDO	568
	134145		134145	Outer	TS	358
	134145		134145	Outer	TS	360
DX	135509		DX135509	Inner	TDO	576
NP	137813		NP137813	Outer	TDI	626
EE	138131	D	EE138131D	Inner	TDI	616
	138172		138172	Outer	TDI	616
K	143253	R	K143253R	Spacer	2S	714
K	143254		K143254	Spacer	2TS-IM	660
K	143256	R	K143256R	Spacer	2TS-IM	660
K	143257	R	K143257R	Spacer	2S	712
K	143262	R	K143262R	Spacer	2S	712
K	143291		K143291	Spacer	2S	714
K	143293	R	K143293R	Spacer	2S	714
HH	144614		HH144614	Outer	TS	342
HH	144642		HH144642	Inner	TS	342
EE	147112		EE147112	Inner	TDO	572
	147198	D	147198D	Outer	TDO	572
K	147783	R	K147783R	Spacer	2S	712
EE	148122		EE148122	Inner	TDO	576
	148220	D	148220D	Outer	TDO	576
K	150486	R	K150486R	Spacer	2S	712
K	152757		K152757	Spacer	2S	712
K	152758		K152758	Spacer	2S	712
K	154145	R	K154145R	Spacer	2TS-IM	660
K	154155		K154155	Spacer	2TS-IM	662
EE	157337		EE157337	Inner	2TS-DM	710
EE	157337		EE157337	Inner	TS	394
Y1S-	157430		Y1S-157430	Spacer	2TS-DM	710
	157430		157430	Outer	2TS-DM	710
	157430		157430	Outer	TS	394
EE	158349		EE158349	Inner	TS	394
EE	158350		EE158350	Inner	TS	394
	158442		158442	Outer	TS	394
K	158596	R	K158596R	Spacer	2TS-IM	660
K	158598	R	K158598R	Spacer	2TS-IM	660
K	158879	R	K158879R	Spacer	2S	712
K	159808	R	K159808R	Spacer	2S	712
K	160046		K160046	Spacer	2TS-IM	676
K	160047		K160047	Spacer	2TS-IM	676
K	160066		K160066	Spacer	2TS-DM	700
K	160075		K160075	Spacer	2TS-IM	660
K	160157		K160157	Spacer	2TS-IM	676
K	160158		K160158	Spacer	2TS-IM	676
K	160264		K160264	Spacer	2TS-DM	704
K	160550		K160550	Spacer	2TS-IM	678
K	160687		K160687	Spacer	2TS-IM	686
K	160929		K160929	Spacer	2TS-IM	678

Prefix	Base	Suffix	Part Number Prefix + Base + Suffix	Part Type	Type	Page No.
HM	161012		HM161012	Outer	TS	370
HM	161040		HM161040	Inner	TS	370
EE	161300		EE161300	Inner	TDO	576
EE	161300		EE161300	Inner	TS	372
EE	161362	D	EE161362D	Inner	TDI	616
EE	161363		EE161363	Inner	TDO	578
EE	161363		EE161363	Inner	TS	372
EE	161363		EE161363	Inner	TS	374
K	161389		K161389	Spacer	2TS-DM	692
EE	161394		EE161394	Inner	TDO	578
EE	161394		EE161394	Inner	TS	374
EE	161400		EE161400	Inner	2TS-IM	684
EE	161400		EE161400	Inner	TDO	578
EE	161400		EE161400	Inner	TS	374
X1S-	161400		X1S-161400	Spacer	2TS-IM	684
EE	161403	D	EE161403D	Inner	TDI	618
K	161554		K161554	Spacer	2TS-IM	668
K	161555		K161555	Spacer	2TS-IM	676
K	161556		K161556	Spacer	2TS-IM	676
K	161561		K161561	Spacer	2TS-IM	674
K	161562		K161562	Spacer	2TS-IM	674
K	161563		K161563	Spacer	2TS-IM	672
K	161564		K161564	Spacer	2TS-IM	672
K	161599		K161599	Spacer	2TS-DM	704
K	161710		K161710	Spacer	2TS-DM	698
K	161783	R	K161783R	Spacer	2S	714
	161850		161850	Outer	TDI	616
	161850		161850	Outer	TS	372
	161850		161850	Outer	TS	374
Y9S-	161900		Y9S-161900	Spacer	2TS-IM	684
	161900		161900	Outer	2TS-IM	684
	161900		161900	Outer	TDI	616
	161900		161900	Outer	TDI	618
	161900		161900	Outer	TS	372
	161900		161900	Outer	TS	374
	161901	CD	161901CD	Outer	TDO	576
	161901	CD	161901CD	Outer	TDO	578
K	161906		K161906	Spacer	2TS-IM	680
K	161907		K161907	Spacer	2TS-IM	680
	161925		161925	Outer	TDI	616
	161925		161925	Outer	TS	374
K	161931		K161931	Spacer	2TS-DM	708
K	161993		K161993	Spacer	2TS-IM	682
K	161994		K161994	Spacer	2TS-IM	682
K	162083		K162083	Spacer	2TS-DM	706
K	162084		K162084	Spacer	2TS-DM	710
K	162211		K162211	Spacer	2TS-DM	706
K	162748		K162748	Spacer	2TS-IM	686
K	162749		K162749	Spacer	2TS-IM	686
K	162853		K162853	Spacer	2TS-IM	662
K	162854		K162854	Spacer	2TS-IM	662
L	163110	CD	L163110CD	Outer	TDO	578
L	163110	CD	L163110CD	Outer	TNASW	652
L	163110	EC	L163110EC	Spacer	2TS-IM	684
L	163110		L163110	Outer	2TS-IM	684
L	163110		L163110	Outer	TDI	618

TAPERED ROLLER BEARINGS

INDEX

Prefix	Base	Suffix	Part Number Prefix + Base + Suffix	Part Type	Type	Page No.
L	163110		L163110	Outer	TS	374
JL	163115		JL163115	Outer	TDI	616
JL	163142	D	JL163142D	Inner	TDI	616
L	163149	D	L163149D	Inner	TDI	618
L	163149	NW	L163149NW	Inner	TNASW	652
L	163149	XS	L163149XS	Spacer	2TS-IM	684
L	163149		L163149	Inner	2TS-IM	684
L	163149		L163149	Inner	TDO	578
L	163149		L163149	Inner	TS	374
K	163370		K163370	Spacer	2TS-IM	682
K	163378		K163378	Spacer	2TS-DM	710
K	163398		K163398	Spacer	2TS-DM	704
K	163675		K163675	Spacer	2TS-IM	668
K	163676		K163676	Spacer	2TS-IM	668
K	163891		K163891	Spacer	2TS-DM	708
K	164387		K164387	Spacer	2TS-IM	684
HM	164615		HM164615	Outer	TS	374
HM	164646		HM164646	Inner	TS	374
K	164781		K164781	Spacer	2TS-IM	680
K	164782		K164782	Spacer	2TS-IM	680
K	165076		K165076	Spacer	2TS-DM	710
K	165354		K165354	Spacer	2TS-IM	660
K	165355		K165355	Spacer	2TS-IM	660
K	165677		K165677	Spacer	2TS-DM	706
K	165765		K165765	Spacer	2TS-IM	682
K	165766		K165766	Spacer	2TS-IM	682
K	166076		K166076	Spacer	2TS-DM	704
K	167026		K167026	Spacer	2TS-DM	710
K	167207		K167207	Spacer	2TS-IM	666
K	167208		K167208	Spacer	2TS-IM	666
K	167396		K167396	Spacer	2TS-DM	704
K	167397		K167397	Spacer	2TS-IM	676
K	167398		K167398	Spacer	2TS-IM	676
K	167429		K167429	Spacer	2TS-DM	710
K	167544		K167544	Spacer	2S	714
K	167806		K167806	Spacer	2TS-IM	676
K	167807		K167807	Spacer	2TS-IM	676
EE	168400		EE168400	Inner	TS	394
	168500		168500	Outer	TS	394
EE	170950		EE170950	Inner	TDO	566
EE	170950		EE170950	Inner	TS	354
EE	170975		EE170975	Inner	TDO	566
EE	170975		EE170975	Inner	TS	356
EE	171000	D	EE171000D	Inner	TDI	608
EE	171000	D	EE171000D	Inner	TDI	610
	171400		171400	Outer	TDI	608
	171400		171400	Outer	TS	354
	171400		171400	Outer	TS	356
	171436		171436	Outer	TDI	610
	171436		171436	Outer	TS	354
	171436		171436	Outer	TS	356
	171450		171450	Outer	TDI	610
	171450		171450	Outer	TS	354
	171450		171450	Outer	TS	356
	171451	CD	171451CD	Outer	TDO	566
DX	175273		DX175273	Thrust	TTHDFL	729

Prefix	Base	Suffix	Part Number Prefix + Base + Suffix	Part Type	Type	Page No.
EE	175300		EE175300	Inner	2TS-DM	710
EE	175300		EE175300	Inner	TS	392
EE	175301		EE175301	Inner	TS	392
Y2S-	175350		Y2S-175350	Spacer	2TS-DM	710
	175350		175350	Outer	2TS-DM	710
	175350		175350	Outer	TS	392
EE	181453		EE181453	Inner	TDO	580
EE	181453		EE181453	Inner	TS	376
EE	181454	D	EE181454D	Inner	TDI	618
	182350		182350	Outer	TDI	618
	182350		182350	Outer	TS	376
	182351	D	182351D	Outer	TDO	580
L	183410		L183410	Outer	TS	392
L	183448		L183448	Inner	TS	392
L	183449		L183449	Inner	TS	392
EE	192148		EE192148	Inner	TDO	580
EE	192148		EE192148	Inner	TS	376
EE	192150		EE192150	Inner	TDO	580
EE	192150		EE192150	Inner	TS	376
	192200		192200	Outer	TS	376
	192201	CD	192201CD	Outer	TDO	580
NP	194866		NP194866	Inner	2TS-DM	710
DX	198514		DX198514	Outer	TDO	562
M	201011		M201011	Outer	TS	156
M	201047		M201047	Inner	TS	156
EE	201250		EE201250	Inner	TS	370
	201800		201800	Outer	TS	370
EE	203130		EE203130	Inner	TS	372
EE	203130		EE203130	Inner	TSF	488
EE	203136		EE203136	Inner	TS	374
EE	203136		EE203136	Inner	TSF	488
EE	203137		EE203137	Inner	TS	374
	203190	-B	203190-B	Outer	TSF	488
	203190		203190	Outer	TS	372
	203190		203190	Outer	TS	374
HM	204010		HM204010	Outer	TS	160
HM	204010		HM204010	Outer	TS	188
HM	204043		HM204043	Inner	TS	160
HM	204049		HM204049	Inner	TS	188
JM	205110	A	JM205110A	Outer	TS	200
JM	205110		JM205110	Outer	2TS-IM	662
JM	205110		JM205110	Outer	SR	716
JM	205110		JM205110	Outer	TS	200
M	205110	ES	M205110ES	Spacer	SR	716
JM	205149	A	JM205149A	Inner	TS	200
JM	205149	AS	JM205149AS	Inner	TS	200
JM	205149		JM205149	Inner	2TS-IM	662
JM	205149		JM205149	Inner	SR	716
JM	205149		JM205149	Inner	TS	200
M	205149	XS	M205149XS	Spacer	SR	716
LL	205410	-B	LL205410-B	Outer	TSF	454
LL	205410		LL205410	Outer	TS	188
LL	205410		LL205410	Outer	TS	200
LL	205442		LL205442	Inner	TS	188
LL	205449		LL205449	Inner	TS	200
LL	205449		LL205449	Inner	TSF	454

Prefix	Base	Suffix	Part Number Prefix + Base + Suffix	Part Type	Type	Page No.
JM	207010	A	JM207010A	Outer	TS	220
JM	207010		JM207010	Outer	2TS-IM	664
JM	207010		JM207010	Outer	SR	716
JM	207010		JM207010	Outer	TS	220
M	207010	EB	M207010EB	Spacer	2TS-IM	664
M	207010	ES	M207010ES	Spacer	2TS-IM	664
M	207010	ES	M207010ES	Spacer	SR	716
JM	207049	A	JM207049A	Inner	TS	220
JM	207049		JM207049	Inner	2TS-IM	664
JM	207049		JM207049	Inner	SR	716
JM	207049		JM207049	Inner	TS	220
M	207049	XA	M207049XA	Spacer	2TS-IM	664
M	207049	XS	M207049XS	Spacer	SR	716
EE	210753		EE210753	Inner	TS	340
	211300		211300	Outer	TS	340
H	211710	ES	H211710ES	Spacer	SR	716
JH	211710		JH211710	Outer	SR	716
JH	211710		JH211710	Outer	TS	248
H	211749	XS	H211749XS	Spacer	SR	716
JH	211749	A	JH211749A	Inner	TS	248
JH	211749		JH211749	Inner	SR	716
JH	211749		JH211749	Inner	TS	248
HM	212010	EA	HM212010EA	Spacer	2TS-DM	690
HM	212010		HM212010	Outer	TS	234
HM	212010		HM212010	Outer	TS	242
HM	212010		HM212010	Outer	TS	252
HM	212011	EA	HM212011EA	Spacer	2TS-DM	690
HM	212011	EB	HM212011EB	Spacer	2TS-IM	666
HM	212011		HM212011	Outer	2TS-DM	690
HM	212011		HM212011	Outer	2TS-IM	666
HM	212011		HM212011	Outer	TS	234
HM	212011		HM212011	Outer	TS	242
HM	212011		HM212011	Outer	TS	244
HM	212011		HM212011	Outer	TS	252
HM	212044		HM212044	Inner	TS	234
HM	212046		HM212046	Inner	TS	242
HM	212046		HM212046	Inner	TS	244
HM	212047		HM212047	Inner	2TS-DM	690
HM	212047		HM212047	Inner	TS	242
HM	212049	X	HM212049X	Inner	TS	252
HM	212049	XS	HM212049XS	Spacer	2TS-IM	666
HM	212049		HM212049	Inner	2TS-DM	690
HM	212049		HM212049	Inner	2TS-IM	666
HM	212049		HM212049	Inner	TS	252
EE	213362		EE213362	Inner	TS	298
	213843		213843	Outer	TS	298
HM	215210		HM215210	Outer	TS	270
HM	215249		HM215249	Inner	TS	270
NP	216163		NP216163	Outer	TS	390
EE	217060		EE217060	Inner	TS	330
EE	217062	X	EE217062X	Inner	2TS-DM	702
EE	217062	X	EE217062X	Inner	TS	332
Y2S-	217112		Y2S-217112	Spacer	2TS-DM	702
	217112		217112	Outer	2TS-DM	702
	217112		217112	Outer	TS	330
	217112		217112	Outer	TS	332

Prefix	Base	Suffix	Part Number Prefix + Base + Suffix	Part Type	Type	Page No.
H	217210	EA	H217210EA	Spacer	2TS-DM	694
H	217210	EA	H217210EA	Spacer	2TS-DM	696
H	217210	ES	H217210ES	Spacer	SR	718
JH	217210		JH217210	Outer	2TS-DM	694
JH	217210		JH217210	Outer	SR	718
JH	217210		JH217210	Outer	TS	286
H	217249	XS	H217249XS	Spacer	SR	718
JH	217249		JH217249	Inner	2TS-DM	694
JH	217249		JH217249	Inner	SR	718
JH	217249		JH217249	Inner	TS	286
L	217810	D	L217810D	Outer	TDO	534
L	217810	D	L217810D	Outer	TDO	536
L	217810		L217810	Outer	TDI	600
L	217810		L217810	Outer	TS	290
LL	217810		LL217810	Outer	2S	714
LL	217810		LL217810	Outer	TS	290
L	217813		L217813	Outer	TDI	600
L	217813		L217813	Outer	TS	290
L	217845	D	L217845D	Inner	TDI	600
L	217847		L217847	Inner	TDO	534
L	217847		L217847	Inner	TS	290
L	217849		L217849	Inner	TDO	536
L	217849		L217849	Inner	TS	290
LL	217849	XB	LL217849XB	Spacer	2S	714
LL	217849		LL217849	Inner	2S	714
LL	217849		LL217849	Inner	TS	290
HM	218210	EA	HM218210EA	Spacer	2TS-DM	694
HM	218210	EB	HM218210EB	Spacer	2TS-IM	670
HM	218210		HM218210	Outer	2TS-DM	694
HM	218210		HM218210	Outer	2TS-IM	670
HM	218210		HM218210	Outer	TS	278
HM	218210		HM218210	Outer	TS	294
HM	218215		HM218215	Outer	TS	278
HM	218238		HM218238	Inner	TS	278
HM	218248	XA	HM218248XA	Spacer	2TS-IM	670
HM	218248		HM218248	Inner	2TS-DM	694
HM	218248		HM218248	Inner	2TS-IM	670
HM	218248		HM218248	Inner	TS	294
EE	219065		EE219065	Inner	TS	334
EE	219068		EE219068	Inner	2TS-IM	680
EE	219068		EE219068	Inner	TS	336
X2S-	219068		X2S-219068	Spacer	2TS-IM	680
Y1S-	219117		Y1S-219117	Spacer	2TS-IM	680
	219117		219117	Outer	2TS-IM	680
	219117		219117	Outer	TS	334
	219117		219117	Outer	TS	336
	219122		219122	Outer	TS	334
	219122		219122	Outer	TS	336
HM	220110		HM220110	Outer	TS	304
HM	220149		HM220149	Inner	TS	304
EH	220710		EH220710	Outer	TS	302
EH	220749		EH220749	Inner	TS	302
EE	221018		EE221018	Inner	TS	360
EE	221026		EE221026	Inner	TDO	568
EE	221026		EE221026	Inner	TS	360
EE	221026		EE221026	Inner	TSF	486

TAPERED ROLLER BEARINGS

INDEX

Prefix	Base	Suffix	Part Number Prefix + Base + Suffix	Part Type	Type	Page No.
NA	221027	SW	NA221027SW	Inner	TNASWE	656
EE	221039	TD	EE221039TD	Inner	TDIT	630
HH	221410	-B	HH221410-B	Outer	TSF	472
HH	221410	-B	HH221410-B	Outer	TSF	474
HH	221410	-B	HH221410-B	Outer	TSF	476
HH	221410	D	HH221410D	Outer	TDO	532
HH	221410	D	HH221410D	Outer	TDO	536
HH	221410	D	HH221410D	Outer	TDO	538
HH	221410	D	HH221410D	Outer	TDO	540
HH	221410	D	HH221410D	Outer	TDO	542
HH	221410	D	HH221410D	Outer	TNA	644
HH	221410	EE	HH221410EE	Spacer	2TS-IM	668
HH	221410	ER	HH221410ER	Spacer	2TS-IM	672
HH	221410		HH221410	Outer	2TS-IM	668
HH	221410		HH221410	Outer	2TS-IM	672
HH	221410		HH221410	Outer	TDIT	630
HH	221410		HH221410	Outer	TS	276
HH	221410		HH221410	Outer	TS	278
HH	221410		HH221410	Outer	TS	290
HH	221410		HH221410	Outer	TS	292
HH	221410		HH221410	Outer	TS	298
HH	221410		HH221410	Outer	TS	302
HH	221410		HH221410	Outer	TS	304
HH	221410		HH221410	Outer	TS	308
JHH	221413		JHH221413	Outer	TS	294
HH	221416		HH221416	Outer	TS	302
HH	221430		HH221430	Inner	TDO	532
HH	221430		HH221430	Inner	TS	276
HH	221431	XA	HH221431XA	Spacer	2TS-IM	668
HH	221431		HH221431	Inner	2TS-IM	668
HH	221431		HH221431	Inner	TS	278
HH	221432		HH221432	Inner	TDO	536
HH	221432		HH221432	Inner	TS	290
HH	221434		HH221434	Inner	TDO	536
HH	221434		HH221434	Inner	TS	292
HH	221434		HH221434	Inner	TSF	472
JHH	221436		JHH221436	Inner	TS	294
HH	221438		HH221438	Inner	TS	298
HH	221440		HH221440	Inner	TDO	538
HH	221440		HH221440	Inner	TS	302
HH	221440		HH221440	Inner	TSF	474
HH	221442		HH221442	Inner	TDO	540
HH	221442		HH221442	Inner	TS	304
HH	221442		HH221442	Inner	TSF	476
HH	221447		HH221447	Inner	TDO	540
HH	221447		HH221447	Inner	TSF	476
HH	221449	A	HH221449A	Inner	TS	308
HH	221449	NA	HH221449NA	Inner	TNA	644
HH	221449	TD	HH221449TD	Inner	TDIT	630
HH	221449	XS	HH221449XS	Spacer	2TS-IM	672
HH	221449		HH221449	Inner	2TS-IM	672
HH	221449		HH221449	Inner	TDO	542
HH	221449		HH221449	Inner	TS	308
HH	221449		HH221449	Inner	TSF	476
	221575	-B	221575-B	Outer	TSF	486
	221575		221575	Outer	TDIT	630

Prefix	Base	Suffix	Part Number Prefix + Base + Suffix	Part Type	Type	Page No.
	221575		221575	Outer	TS	360
	221576	CD	221576CD	Outer	TDO	568
	221576	CD	221576CD	Outer	TNASWE	656
EE	222070		EE222070	Inner	TDO	556
	222127	CD	222127CD	Outer	TDO	556
EE	224115		EE224115	Inner	TDO	574
EE	224115		EE224115	Inner	TS	366
	224204		224204	Outer	TS	366
	224205	D	224205D	Outer	TDO	574
HH	224310	-B	HH224310-B	Outer	TSF	476
HH	224310	-B	HH224310-B	Outer	TSF	478
HH	224310	CD	HH224310CD	Outer	TDO	540
HH	224310	CD	HH224310CD	Outer	TDO	542
HH	224310	CD	HH224310CD	Outer	TDO	544
HH	224310	CD	HH224310CD	Outer	TDO	546
HH	224310	EC	HH224310EC	Spacer	2TS-DM	698
HH	224310	EX	HH224310EX	Spacer	2TS-IM	674
HH	224310		HH224310	Outer	2TS-DM	698
HH	224310		HH224310	Outer	2TS-IM	670
HH	224310		HH224310	Outer	2TS-IM	674
HH	224310		HH224310	Outer	TDI	602
HH	224310		HH224310	Outer	TS	304
HH	224310		HH224310	Outer	TS	308
HH	224310		HH224310	Outer	TS	310
HH	224310		HH224310	Outer	TS	314
HH	224314		HH224314	Outer	TS	304
HH	224314		HH224314	Outer	TS	308
HH	224314		HH224314	Outer	TS	314
JHH	224315		JHH224315	Outer	TS	304
HH	224332		HH224332	Inner	TDO	540
HH	224332		HH224332	Inner	TS	304
HH	224332		HH224332	Inner	TSF	476
JHH	224333		JHH224333	Inner	TS	304
HH	224334	XA	HH224334XA	Spacer	2TS-IM	670
HH	224334		HH224334	Inner	2TS-IM	670
HH	224334		HH224334	Inner	TDO	540
HH	224334		HH224334	Inner	TS	304
HH	224335		HH224335	Inner	TDO	542
HH	224335		HH224335	Inner	TS	308
HH	224340		HH224340	Inner	2TS-DM	698
HH	224340		HH224340	Inner	TDO	544
HH	224340		HH224340	Inner	TS	310
HH	224340		HH224340	Inner	TSF	478
HH	224346	DD	HH224346DD	Inner	TDI	602
HH	224346	XC	HH224346XC	Spacer	2TS-IM	674
HH	224346		HH224346	Inner	2TS-IM	674
HH	224346		HH224346	Inner	TDO	546
HH	224346		HH224346	Inner	TS	314
HH	224349		HH224349	Inner	TDO	546
HH	224349		HH224349	Inner	TS	314
M	224710	D	M224710D	Outer	TDO	546
M	224710		M224710	Outer	TDI	602
M	224710		M224710	Outer	TS	316
M	224711		M224711	Outer	TS	316
M	224712		M224712	Outer	TS	316
M	224748		M224748	Inner	TS	316

Prefix	Base	Suffix	Part Number Prefix + Base + Suffix	Part Type	Type	Page No.
M	224749	D	M224749D	Inner	TDI	602
M	224749		M224749	Inner	TDO	546
M	224749		M224749	Inner	TS	316
LL	225710		LL225710	Outer	TS	318
NP	225734		NP225734	Outer	TS	356
LL	225749		LL225749	Inner	TS	318
L	225810		L225810	Outer	TS	316
L	225810		L225810	Outer	TS	318
L	225812	D	L225812D	Outer	TDO	546
L	225818		L225818	Outer	TS	316
L	225818		L225818	Outer	TS	318
L	225842		L225842	Inner	TS	316
L	225849		L225849	Inner	TDO	546
L	225849		L225849	Inner	TS	318
HM	227519	EE	HM227519EE	Spacer	2TS-IM	676
HM	227519		HM227519	Outer	2TS-IM	676
HM	227545	XB	HM227545XB	Spacer	2TS-IM	676
HM	227545		HM227545	Inner	2TS-IM	676
HH	228310	EA	HH228310EA	Spacer	2TS-DM	698
HH	228310		HH228310	Outer	2TS-DM	698
HH	228310		HH228310	Outer	TS	318
HH	228310		HH228310	Outer	TS	320
HH	228318		HH228318	Outer	TS	318
HH	228340		HH228340	Inner	2TS-DM	698
HH	228340		HH228340	Inner	TS	318
HH	228349		HH228349	Inner	TS	320
H	228610		H228610	Outer	TDI	604
H	228649	D	H228649D	Inner	TDI	604
M	229310		M229310	Outer	TS	328
M	229349	A	M229349A	Inner	TS	328
M	229349		M229349	Inner	TS	328
HM	231110	EC	HM231110EC	Spacer	2TS-DM	702
HM	231110	EE	HM231110EE	Spacer	2TS-IM	678
HM	231110	ES	HM231110ES	Spacer	2TS-IM	678
HM	231110		HM231110	Outer	2TS-DM	702
HM	231110		HM231110	Outer	2TS-IM	678
HM	231110		HM231110	Outer	TS	324
HM	231110		HM231110	Outer	TS	328
HM	231111	CD	HM231111CD	Outer	TDO	550
HM	231111	CD	HM231111CD	Outer	TDO	552
HM	231115	-B	HM231115-B	Outer	TSF	480
HM	231115	-B	HM231115-B	Outer	TSF	482
HM	231115	EC	HM231115EC	Spacer	2TS-IM	678
HM	231115		HM231115	Outer	2TS-IM	678
HM	231115		HM231115	Outer	TS	324
HM	231115		HM231115	Outer	TS	326
HM	231115		HM231115	Outer	TS	328
HM	231116	D	HM231116D	Outer	TNA	644
HM	231132		HM231132	Inner	TDO	550
HM	231132		HM231132	Inner	TS	324
HM	231132		HM231132	Inner	TSF	480
HM	231136		HM231136	Inner	TS	326
HM	231136		HM231136	Inner	TSF	482
HM	231140	NA	HM231140NA	Inner	TNA	644
HM	231140		HM231140	Inner	TDO	552
HM	231140		HM231140	Inner	TS	328

Prefix	Base	Suffix	Part Number Prefix + Base + Suffix	Part Type	Type	Page No.
HM	231140		HM231140	Inner	TSF	482
HM	231148	XB	HM231148XB	Spacer	2TS-IM	678
HM	231148	XE	HM231148XE	Spacer	2TS-IM	678
HM	231148		HM231148	Inner	2TS-IM	678
HM	231148		HM231148	Inner	TDO	552
HM	231148		HM231148	Inner	TS	328
HM	231149	NA	HM231149NA	Inner	TNA	644
HM	231149	XC	HM231149XC	Spacer	2TS-IM	678
HM	231149		HM231149	Inner	2TS-DM	702
HM	231149		HM231149	Inner	2TS-IM	678
HM	231149		HM231149	Inner	TDO	552
HM	231149		HM231149	Inner	TS	328
HM	231149		HM231149	Inner	TSF	482
EE	231400		EE231400	Inner	TDO	578
EE	231400		EE231400	Inner	TDO	580
EE	231400		EE231400	Inner	TS	374
NA	231400		NA231400	Inner	TNA	646
EE	231401	D	EE231401D	Inner	TDI	618
EE	231462		EE231462	Inner	TDO	580
EE	231462		EE231462	Inner	TS	376
EE	231462		EE231462	Inner	TSF	488
EE	231475	D	EE231475D	Inner	TDI	618
EE	231475	D	EE231475D	Inner	TDI	620
HH	231610		HH231610	Outer	TS	320
HH	231610		HH231610	Outer	TS	326
M	231610	CD	M231610CD	Outer	TDO	552
M	231610		M231610	Outer	2TS-DM	702
HH	231615		HH231615	Outer	2TS-IM	676
HH	231615		HH231615	Outer	TS	320
HH	231615		HH231615	Outer	TS	326
M	231616	XD	M231616XD	Outer	TNA	644
HH	231637		HH231637	Inner	TS	320
M	231647		M231647	Inner	TNA	644
HH	231649	XB	HH231649XB	Spacer	2TS-IM	676
HH	231649		HH231649	Inner	2TS-IM	676
HH	231649		HH231649	Inner	TS	326
M	231649		M231649	Inner	2TS-DM	702
M	231649		M231649	Inner	TDO	552
	231975		231975	Outer	TDI	618
	231975		231975	Outer	TS	374
	231975		231975	Outer	TS	376
	231976	CD	231976CD	Outer	TDO	578
	231976	CD	231976CD	Outer	TDO	580
	232000	-B	232000-B	Outer	TSF	488
	232025		232025	Outer	TDI	618
	232025		232025	Outer	TDI	620
	232025		232025	Outer	TS	374
	232025		232025	Outer	TS	376
	232026	D	232026D	Outer	TDO	580
	232026	D	232026D	Outer	TNA	646
HH	234010	EC	HH234010EC	Spacer	2TS-DM	702
HH	234010		HH234010	Outer	2TS-DM	702
HH	234010		HH234010	Outer	2TS-IM	676
HH	234010		HH234010	Outer	TS	326
HH	234010		HH234010	Outer	TS	328
HH	234010		HH234010	Outer	TS	330

TAPERED ROLLER BEARINGS

INDEX

Prefix	Base	Suffix	Part Number Prefix + Base + Suffix	Part Type	Type	Page No.
HH	234011	CD	HH234011CD	Outer	TDO	550
HH	234011	CD	HH234011CD	Outer	TDO	554
HH	234018		HH234018	Outer	TS	332
HH	234031	XA	HH234031XA	Spacer	2TS-IM	676
HH	234031		HH234031	Inner	2TS-IM	676
HH	234031		HH234031	Inner	TDO	550
HH	234031		HH234031	Inner	TS	326
HH	234032		HH234032	Inner	TDO	550
HH	234032		HH234032	Inner	TS	326
HH	234040		HH234040	Inner	TS	328
HH	234048		HH234048	Inner	2TS-DM	702
HH	234048		HH234048	Inner	TDO	554
HH	234048		HH234048	Inner	TS	330
HH	234049		HH234049	Inner	TDO	554
HH	234049		HH234049	Inner	TS	330
HH	234049		HH234049	Inner	TS	332
EE	234154		EE234154	Inner	TDO	582
EE	234154		EE234154	Inner	TS	378
EE	234156		EE234156	Inner	TDO	582
EE	234156		EE234156	Inner	TS	378
EE	234157	D	EE234157D	Inner	TDI	620
EE	234160	A	EE234160A	Inner	TS	378
EE	234160		EE234160	Inner	TDO	582
EE	234160		EE234160	Inner	TS	378
EE	234160		EE234160	Inner	TS	380
EE	234161	D	EE234161D	Inner	TDI	620
	234213	CD	234213CD	Outer	TDO	582
	234215	X	234215X	Outer	TS	378
	234215		234215	Outer	TDI	620
	234215		234215	Outer	TS	378
	234216	D	234216D	Outer	TDO	582
	234220		234220	Outer	TDI	620
	234220		234220	Outer	TS	378
	234220		234220	Outer	TS	380
	234221	D	234221D	Outer	TDO	582
M	235113	CD	M235113CD	Outer	TDO	554
M	235113		M235113	Outer	TS	334
M	235145		M235145	Inner	TDO	554
M	235149		M235149	Inner	TDO	554
M	235149		M235149	Inner	TS	334
LM	236710	A	LM236710A	Outer	TS	338
LM	236710		LM236710	Outer	TS	338
LM	236749		LM236749	Inner	TS	338
M	236810		M236810	Outer	TS	336
M	236845		M236845	Inner	TS	336
M	236848		M236848	Inner	TS	336
M	236849		M236849	Inner	TS	336
HM	237510	-B	HM237510-B	Outer	TSF	482
HM	237510	-B	HM237510-B	Outer	TSF	484
HM	237510	CA	HM237510CA	Spacer	2TS-IM	680
HM	237510	CD	HM237510CD	Outer	TDO	554
HM	237510	CD	HM237510CD	Outer	TDO	556
HM	237510	ED	HM237510ED	Spacer	2TS-DM	704
HM	237510		HM237510	Outer	2TS-DM	704
HM	237510		HM237510	Outer	2TS-IM	680
HM	237510		HM237510	Outer	TDI	604

Prefix	Base	Suffix	Part Number Prefix + Base + Suffix	Part Type	Type	Page No.
HM	237510		HM237510	Outer	TS	332
HM	237510		HM237510	Outer	TS	334
HM	237510		HM237510	Outer	TS	336
HM	237532		HM237532	Inner	TDO	554
HM	237532		HM237532	Inner	TS	332
HM	237532		HM237532	Inner	TSF	482
HM	237535		HM237535	Inner	TDO	554
HM	237535		HM237535	Inner	TS	334
HM	237536		HM237536	Inner	TS	334
HM	237542	D	HM237542D	Inner	TDI	604
HM	237542		HM237542	Inner	TDO	556
HM	237542		HM237542	Inner	TSF	484
HM	237545	H	HM237545H	Inner	TDO	556
HM	237545	XC	HM237545XC	Spacer	2TS-IM	680
HM	237545		HM237545	Inner	2TS-DM	704
HM	237545		HM237545	Inner	2TS-IM	680
HM	237545		HM237545	Inner	TDO	556
HM	237545		HM237545	Inner	TS	336
HM	237546	D	HM237546D	Inner	TDI	604
H	238110	EA	H238110EA	Spacer	2TS-DM	702
H	238110		H238110	Outer	2TS-DM	702
H	238110		H238110	Outer	2TS-IM	680
H	238110		H238110	Outer	TS	334
H	238110		H238110	Outer	TS	336
H	238140		H238140	Inner	2TS-DM	702
H	238140		H238140	Inner	TS	334
H	238148	XA	H238148XA	Spacer	2TS-IM	680
H	238148		H238148	Inner	2TS-IM	680
H	238148		H238148	Inner	TS	336
M	238810	CD	M238810CD	Outer	TDO	556
M	238810	CD	M238810CD	Outer	TDO	558
M	238810		M238810	Outer	TS	336
M	238810		M238810	Outer	TS	340
M	238840		M238840	Inner	TDO	556
M	238840		M238840	Inner	TS	336
JM	238848		JM238848	Inner	TS	340
M	238849		M238849	Inner	TDO	558
M	238849		M238849	Inner	TS	340
EE	239171	D	EE239171D	Inner	TDI	620
EE	239173	D	EE239173D	Inner	TDI	622
	239225		239225	Outer	TDI	620
	239225		239225	Outer	TDI	622
H	239610		H239610	Outer	TDI	604
H	239610		H239610	Outer	TS	338
H	239612	CD	H239612CD	Outer	TDO	556
H	239612	CD	H239612CD	Outer	TDO	558
H	239612		H239612	Outer	TDI	604
H	239612		H239612	Outer	TS	338
H	239612		H239612	Outer	TS	340
H	239640		H239640	Inner	TDO	556
H	239640		H239640	Inner	TS	338
H	239649	D	H239649D	Inner	TDI	604
H	239649		H239649	Inner	TDO	558
H	239649		H239649	Inner	TS	340
LM	241110	D	LM241110D	Outer	TNASWE	656
LM	241110		LM241110	Outer	TS	344

Prefix	Base	Suffix	Part Number Prefix + Base + Suffix	Part Type	Type	Page No.
LM	241149	NW	LM241149NW	Inner	TNASWE	656
LM	241149		LM241149	Inner	TS	344
M	241510	CD	M241510CD	Outer	TDO	558
M	241510	CD	M241510CD	Outer	TDO	560
M	241510	EC	M241510EC	Spacer	2TS-DM	706
M	241510		M241510	Outer	2TS-DM	706
M	241510		M241510	Outer	TS	342
M	241510		M241510	Outer	TS	344
JM	241511		JM241511	Outer	2TS-IM	680
M	241511	EA	M241511EA	Spacer	2TS-IM	680
JM	241538		JM241538	Inner	2TS-IM	680
M	241543		M241543	Inner	TDO	558
M	241543		M241543	Inner	TS	342
M	241547	C	M241547C	Inner	TS	344
M	241547	H	M241547H	Inner	TDO	558
M	241547		M241547	Inner	TDO	558
M	241547		M241547	Inner	TS	344
M	241549		M241549	Inner	2TS-DM	706
M	241549		M241549	Inner	TDO	560
M	241549		M241549	Inner	TS	344
EE	241693		EE241693	Inner	TDO	584
EE	241693		EE241693	Inner	TS	380
EE	241701		EE241701	Inner	TDO	584
EE	241701		EE241701	Inner	TS	382
	242375		242375	Outer	TS	380
	242375		242375	Outer	TS	382
	242376	D	242376D	Outer	TDO	584
	242377	CD	242377CD	Outer	TDO	584
H	242610	CD	H242610CD	Outer	TDO	560
H	242610		H242610	Outer	2TS-DM	706
H	242610		H242610	Outer	2TS-IM	682
H	242610		H242610	Outer	TDI	606
H	242610		H242610	Outer	TDIT	630
H	242610		H242610	Outer	TS	346
H	242649	D	H242649D	Inner	TDI	606
H	242649	TD	H242649TD	Inner	TDIT	630
H	242649		H242649	Inner	2TS-DM	706
H	242649		H242649	Inner	2TS-IM	682
H	242649		H242649	Inner	TDO	560
H	242649		H242649	Inner	TS	346
EE	243190		EE243190	Inner	TDO	586
EE	243190		EE243190	Inner	TDO	588
EE	243190		EE243190	Inner	TS	384
EE	243190		EE243190	Inner	TSF	490
EE	243192		EE243192	Inner	TDO	588
EE	243192		EE243192	Inner	TS	384
EE	243192		EE243192	Inner	TSF	490
EE	243193	D	EE243193D	Inner	TDI	624
EE	243196		EE243196	Inner	TDO	588
EE	243196		EE243196	Inner	TS	384
EE	243196		EE243196	Inner	TSF	490
EE	243197		EE243197	Inner	TS	384
	243250	-B	243250-B	Outer	TSF	490
	243250		243250	Outer	TDI	624
	243250		243250	Outer	TS	384
	243251	CD	243251CD	Outer	TDO	586

Prefix	Base	Suffix	Part Number Prefix + Base + Suffix	Part Type	Type	Page No.
	243251	CD	243251CD	Outer	TDO	588
	243251	D	243251D	Outer	TDO	588
EE	244180		EE244180	Inner	TDO	586
EE	244180		EE244180	Inner	TS	384
EE	244180		EE244180	Inner	TSF	490
EE	244181	D	EE244181D	Inner	TDI	622
M	244210	-B	M244210-B	Outer	TSF	484
M	244210	-B	M244210-B	Outer	TSF	486
M	244210	CD	M244210CD	Outer	TDO	562
M	244210	ER	M244210ER	Spacer	2TS-IM	682
M	244210		M244210	Outer	2TS-IM	682
M	244210		M244210	Outer	TDI	606
M	244210		M244210	Outer	TDIT	630
M	244210		M244210	Outer	TS	348
	244235	-B	244235-B	Outer	TSF	490
	244235		244235	Outer	TDI	622
	244235		244235	Outer	TS	384
	244236	CD	244236CD	Outer	TDO	586
M	244246	TD	M244246TD	Inner	TDIT	630
M	244249	A	M244249A	Inner	TS	348
M	244249	A	M244249A	Inner	TSF	486
M	244249	D	M244249D	Inner	TDI	606
M	244249	XA	M244249XA	Spacer	2TS-IM	682
M	244249		M244249	Inner	2TS-IM	682
M	244249		M244249	Inner	TDO	562
M	244249		M244249	Inner	TS	348
M	244249		M244249	Inner	TSF	484
LL	244510		LL244510	Outer	TS	350
LL	244549		LL244549	Inner	TS	350
H	244810		H244810	Outer	TDI	606
H	244810		H244810	Outer	TDIT	630
H	244848	TD	H244848TD	Inner	TDIT	630
H	244849	D	H244849D	Inner	TDI	606
LM	246310	D	LM246310D	Outer	TNASW	650
LM	246349	NW	LM246349NW	Inner	TNASW	650
M	246910		M246910	Outer	TS	346
M	246910		M246910	Outer	TS	352
M	246910		M246910	Outer	TS	354
M	246932		M246932	Inner	TS	346
M	246942		M246942	Inner	TS	352
M	246947	AA	M246947AA	Inner	TS	354
M	246947		M246947	Inner	TS	354
M	246948		M246948	Inner	TS	354
M	246949		M246949	Inner	TS	354
H	247510	CD	H247510CD	Outer	TDO	558
H	247510	CD	H247510CD	Outer	TDO	564
H	247510	EB	H247510EB	Spacer	2TS-DM	708
H	247510	EF	H247510EF	Spacer	2TS-IM	682
H	247510		H247510	Outer	2TS-DM	708
H	247510		H247510	Outer	2TS-IM	682
H	247510		H247510	Outer	TDI	608
H	247510		H247510	Outer	TS	342
H	247510		H247510	Outer	TS	348
H	247510		H247510	Outer	TS	352
H	247535		H247535	Inner	TDO	558
H	247535		H247535	Inner	TS	342

TAPERED ROLLER BEARINGS

INDEX

Prefix	Base	Suffix	Part Number Prefix + Base + Suffix	Part Type	Type	Page No.
H	247536		H247536	Inner	TDO	558
H	247540		H247540	Inner	TS	348
H	247548		H247548	Inner	TDO	564
H	247548		H247548	Inner	TS	352
H	247549	D	H247549D	Inner	TDI	608
H	247549	XE	H247549XE	Spacer	2TS-IM	682
H	247549		H247549	Inner	2TS-DM	708
H	247549		H247549	Inner	2TS-IM	682
H	247549		H247549	Inner	TDO	564
H	247549		H247549	Inner	TS	352
LM	247710		LM247710	Outer	TDI	608
LM	247710		LM247710	Outer	TDIT	630
LM	247747	TD	LM247747TD	Inner	TDIT	630
LM	247748	D	LM247748D	Inner	TDI	608
H	249111	CD	H249111CD	Outer	TDO	566
H	249148		H249148	Inner	TDO	566
LM	249710	CD	LM249710CD	Outer	TDO	566
LM	249710	CD	LM249710CD	Outer	TNASWE	656
M	249710	-B	M249710-B	Outer	TSF	486
M	249710	CD	M249710CD	Outer	TDO	564
M	249710	CD	M249710CD	Outer	TDO	568
M	249710	EW	M249710EW	Spacer	2TS-IM	684
M	249710	EX	M249710EX	Spacer	2TS-IM	684
M	249710	X	M249710X	Outer	TS	352
M	249710	X	M249710X	Outer	TS	358
M	249710		M249710	Outer	2TS-IM	684
M	249710		M249710	Outer	TDI	608
M	249710		M249710	Outer	TDIT	630
M	249710		M249710	Outer	TS	350
M	249710		M249710	Outer	TS	354
M	249710		M249710	Outer	TS	358
M	249711	-B	M249711-B	Outer	TSF	486
JM	249712		JM249712	Outer	TDI	608
M	249732		M249732	Inner	TDO	564
M	249732		M249732	Inner	TS	350
M	249734	H	M249734H	Inner	TS	352
M	249734		M249734	Inner	TDO	564
M	249734		M249734	Inner	TS	350
M	249736		M249736	Inner	TDO	564
M	249736		M249736	Inner	TS	354
M	249746	TD	M249746TD	Inner	TDIT	630
LM	249747	NW	LM249747NW	Inner	TNASWE	656
M	249747	XB	M249747XB	Spacer	2TS-IM	684
M	249747		M249747	Inner	2TS-IM	684
LM	249748		LM249748	Inner	TDO	566
M	249748	D	M249748D	Inner	TDI	608
M	249749	AH	M249749AH	Inner	2TS-IM	684
M	249749	AH	M249749AH	Inner	TSF	486
M	249749	H	M249749H	Inner	TS	358
M	249749	X	M249749X	Inner	TS	358
M	249749	XS	M249749XS	Spacer	2TS-IM	684
M	249749		M249749	Inner	TDO	568
M	249749		M249749	Inner	TS	358
M	249749		M249749	Inner	TSF	486
HH	249910	CD	HH249910CD	Outer	TDO	566
HH	249910	ES	HH249910ES	Spacer	2TS-DM	708

Prefix	Base	Suffix	Part Number Prefix + Base + Suffix	Part Type	Type	Page No.
HH	249910		HH249910	Outer	2TS-DM	708
HH	249910		HH249910	Outer	2TS-IM	684
HH	249910		HH249910	Outer	TDI	608
HH	249910		HH249910	Outer	TS	356
HH	249949	D	HH249949D	Inner	TDI	608
HH	249949	H	HH249949H	Inner	2TS-IM	684
HH	249949	H	HH249949H	Inner	TS	356
HH	249949	XA	HH249949XA	Spacer	2TS-IM	684
HH	249949		HH249949	Inner	2TS-DM	708
HH	249949		HH249949	Inner	TDO	566
HH	249949		HH249949	Inner	TS	356
EE	251001		EE251001	Inner	TS	358
	251575		251575	Outer	TS	358
LM	251610	D	LM251610D	Outer	TNASWE	656
LM	251649	NW	LM251649NW	Inner	TNASWE	656
HM	252310	CD	HM252310CD	Outer	TDO	568
HM	252310	CD	HM252310CD	Outer	TDO	570
HM	252310		HM252310	Outer	TDI	610
HM	252310		HM252310	Outer	TS	358
HM	252310		HM252310	Outer	TS	360
M	252310	CD	M252310CD	Outer	TDO	566
M	252310	CD	M252310CD	Outer	TDO	570
M	252310	X	M252310X	Outer	TS	364
M	252310		M252310	Outer	TDI	612
M	252310		M252310	Outer	TDIT	630
M	252310		M252310	Outer	TS	352
M	252310		M252310	Outer	TS	356
M	252310		M252310	Outer	TS	364
HM	252311	D	HM252311D	Outer	TDO	568
HM	252311	D	HM252311D	Outer	TDO	570
HM	252311	D	HM252311D	Outer	TNA	646
HM	252312	D	HM252312D	Outer	TDO	570
HM	252315	CD	HM252315CD	Outer	TNA	646
HM	252315	D	HM252315D	Outer	TDO	568
HM	252315	D	HM252315D	Outer	TDO	570
HM	252315		HM252315	Outer	TDI	610
HM	252315		HM252315	Outer	TS	358
HM	252315		HM252315	Outer	TS	360
M	252330		M252330	Inner	TS	352
M	252337		M252337	Inner	TDO	566
M	252337		M252337	Inner	TS	356
HM	252343	D	HM252343D	Inner	TDI	610
HM	252343	NA	HM252343NA	Inner	TNA	646
HM	252343		HM252343	Inner	TDO	568
HM	252343		HM252343	Inner	TS	358
HM	252344	NA	HM252344NA	Inner	TNA	646
HM	252344		HM252344	Inner	TDO	568
HM	252344		HM252344	Inner	TS	358
HM	252347	D	HM252347D	Inner	TDI	610
HM	252348	D	HM252348D	Inner	TDI	610
HM	252348	NA	HM252348NA	Inner	TNA	646
HM	252348		HM252348	Inner	TDO	570
HM	252348		HM252348	Inner	TS	360
HM	252349	NA	HM252349NA	Inner	TNA	646
HM	252349		HM252349	Inner	TDO	570
HM	252349		HM252349	Inner	TS	360

Prefix	Base	Suffix	Part Number Prefix + Base + Suffix	Part Type	Type	Page No.
M	252349	D	M252349D	Inner	TDI	612
M	252349	H	M252349H	Inner	TS	364
M	252349	TD	M252349TD	Inner	TDIT	630
M	252349		M252349	Inner	TDO	570
M	252349		M252349	Inner	TS	364
HH	255110		HH255110	Outer	TDI	612
HH	255149	D	HH255149D	Inner	TDI	612
M	255410	CD	M255410CD	Outer	TDO	572
M	255410		M255410	Outer	2TS-IM	684
M	255410		M255410	Outer	TDI	612
M	255410		M255410	Outer	TDIT	632
M	255410		M255410	Outer	TS	366
M	255449	D	M255449D	Inner	TDI	612
M	255449	H	M255449H	Inner	TDO	572
M	255449	H	M255449H	Inner	TS	366
M	255449	TD	M255449TD	Inner	TDIT	632
M	255449	XB	M255449XB	Spacer	2TS-IM	684
M	255449		M255449	Inner	2TS-IM	684
M	255449		M255449	Inner	TS	366
HM	256810	CD	HM256810CD	Outer	TDO	574
HM	256810	D	HM256810D	Outer	TDO	574
HM	256810		HM256810	Outer	TDI	614
HM	256810		HM256810	Outer	TDIT	632
HM	256810		HM256810	Outer	TS	368
HM	256846	TD	HM256846TD	Inner	TDIT	632
HM	256849	D	HM256849D	Inner	TDI	614
HM	256849	DA	HM256849DA	Inner	TDI	614
HM	256849		HM256849	Inner	TDO	574
HM	256849		HM256849	Inner	TS	368
M	257110		M257110	Outer	TDI	614
M	257149	D	M257149D	Inner	TDI	614
M	257210		M257210	Outer	TDI	614
M	257248	D	M257248D	Inner	TDI	614
HH	258210	CD	HH258210CD	Outer	TDO	574
HH	258210		HH258210	Outer	TDI	614
HH	258210		HH258210	Outer	TDIT	632
HH	258210		HH258210	Outer	TS	360
HH	258210		HH258210	Outer	TS	368
JHH	258211	CD	JHH258211CD	Outer	TDO	574
HH	258232		HH258232	Inner	TS	360
JHH	258247		JHH258247	Inner	TDO	574
HH	258248		HH258248	Inner	TDO	574
HH	258248		HH258248	Inner	TS	368
HH	258249	D	HH258249D	Inner	TDI	614
HH	258249	TD	HH258249TD	Inner	TDIT	632
LM	258610		LM258610	Outer	TDI	616
LM	258649	D	LM258649D	Inner	TDI	616
HM	258910		HM258910	Outer	TDI	614
HM	258949	D	HM258949D	Inner	TDI	614
HM	259010	CD	HM259010CD	Outer	TDO	576
HM	259010	D	HM259010D	Outer	TDO	576
HM	259010		HM259010	Outer	TDI	616
HM	259010		HM259010	Outer	TDIT	632
HM	259010		HM259010	Outer	TS	370
HM	259045	TD	HM259045TD	Inner	TDIT	632
HM	259048		HM259048	Inner	TS	370

Prefix	Base	Suffix	Part Number Prefix + Base + Suffix	Part Type	Type	Page No.
HM	259049	D	HM259049D	Inner	TDI	616
HM	259049		HM259049	Inner	TDO	576
HM	259049		HM259049	Inner	TS	370
L	259710		L259710	Outer	TDI	616
L	259749	D	L259749D	Inner	TDI	616
HM	261010	CD	HM261010CD	Outer	TDO	578
HM	261010		HM261010	Outer	TDI	616
HM	261010		HM261010	Outer	TDIT	632
HM	261010		HM261010	Outer	TS	372
HM	261049	D	HM261049D	Inner	TDI	616
HM	261049	H	HM261049H	Inner	TDO	578
HM	261049	TD	HM261049TD	Inner	TDIT	632
HM	261049		HM261049	Inner	TDO	578
HM	261049		HM261049	Inner	TS	372
M	262410		M262410	Outer	TDI	618
M	262410		M262410	Outer	TDIT	632
M	262448	TD	M262448TD	Inner	TDIT	632
M	262449	D	M262449D	Inner	TDI	618
HM	262710	CD	HM262710CD	Outer	TDO	578
HM	262710		HM262710	Outer	TDI	618
HM	262710		HM262710	Outer	TDIT	632
HM	262710		HM262710	Outer	TS	374
HM	262748		HM262748	Inner	TDO	578
HM	262748		HM262748	Inner	TS	374
HM	262749	D	HM262749D	Inner	TDI	618
HM	262749	TD	HM262749TD	Inner	TDIT	632
HM	262749		HM262749	Inner	TDO	578
HM	262749		HM262749	Inner	TS	374
NP	262883		NP262883	Inner	TDO	580
LM	263110		LM263110	Outer	TDI	618
LM	263110		LM263110	Outer	TDIT	632
LM	263112		LM263112	Outer	TDI	618
LM	263145	TD	LM263145TD	Inner	TDIT	632
LM	263149	D	LM263149D	Inner	TDI	618
M	263310		M263310	Outer	TDI	618
M	263349	D	M263349D	Inner	TDI	618
NP	263541		NP263541	Outer	TS	378
H	263910	D	H263910D	Outer	TDO	578
H	263949		H263949	Inner	TDO	578
HH	264110	CD	HH264110CD	Outer	TDO	578
HH	264149		HH264149	Inner	TDO	578
LL	264610		LL264610	Outer	TS	376
LL	264648		LL264648	Inner	TS	376
HM	265010	CD	HM265010CD	Outer	TDO	580
HM	265010		HM265010	Outer	TDI	618
HM	265010		HM265010	Outer	TDIT	632
HM	265010		HM265010	Outer	TS	376
HM	265032	TD	HM265032TD	Inner	TDIT	632
HM	265049	D	HM265049D	Inner	TDI	618
HM	265049	TD	HM265049TD	Inner	TDIT	632
HM	265049		HM265049	Inner	TDO	580
HM	265049		HM265049	Inner	TS	376
NP	266377		NP266377	Inner	TS	386
HM	266410	CD	HM266410CD	Outer	TDO	580
HM	266410	CD	HM266410CD	Outer	TDO	582
HM	266410		HM266410	Outer	TDI	618

TAPERED ROLLER BEARINGS

INDEX

Prefix	Base	Suffix	Part Number Prefix + Base + Suffix	Part Type	Type	Page No.
HM	266410		HM266410	Outer	TDI	620
HM	266410		HM266410	Outer	TDIT	632
HM	266410		HM266410	Outer	TS	376
HM	266410		HM266410	Outer	TS	378
HM	266445	D	HM266445D	Inner	TDI	618
HM	266446		HM266446	Inner	TDO	580
HM	266446		HM266446	Inner	TS	378
HM	266447		HM266447	Inner	TDO	580
HM	266447		HM266447	Inner	TS	376
HM	266448	D	HM266448D	Inner	TDI	620
HM	266448		HM266448	Inner	TDO	580
HM	266448		HM266448	Inner	TS	378
HM	266449	D	HM266449D	Inner	TDI	620
HM	266449	TD	HM266449TD	Inner	TDIT	632
HM	266449		HM266449	Inner	TDO	582
HM	266449		HM266449	Inner	TS	378
NP	267201		NP267201	Inner	TS	386
HH	267610	D	HH267610D	Outer	TDO	580
HH	267648		HH267648	Inner	TDO	580
M	268710	CD	M268710CD	Outer	TDO	580
M	268710	CD	M268710CD	Outer	TDO	584
M	268710	D	M268710D	Outer	TDO	580
M	268710	D	M268710D	Outer	TDO	584
M	268710		M268710	Outer	TDI	620
M	268710		M268710	Outer	TDIT	632
M	268710		M268710	Outer	TS	378
M	268710		M268710	Outer	TS	380
M	268730		M268730	Inner	TDO	580
M	268730		M268730	Inner	TS	378
M	268742		M268742	Inner	TS	380
M	268743	TD	M268743TD	Inner	TDIT	632
M	268748	D	M268748D	Inner	TDI	620
M	268749	TD	M268749TD	Inner	TDIT	632
M	268749		M268749	Inner	TDO	584
M	268749		M268749	Inner	TS	380
L	269110		L269110	Outer	TS	380
L	269110		L269110	Outer	TS	382
L	269140		L269140	Inner	TS	380
L	269143		L269143	Inner	TS	382
M	270410		M270410	Outer	TDI	622
M	270449	DA	M270449DA	Inner	TDI	622
M	270710	CD	M270710CD	Outer	TDO	584
M	270710	CD	M270710CD	Outer	TDO	586
M	270710		M270710	Outer	TDI	622
M	270710		M270710	Outer	TDIT	632
M	270710		M270710	Outer	TS	382
M	270720	D	M270720D	Outer	TDO	586
M	270730		M270730	Inner	TDO	584
M	270744		M270744	Inner	TS	382
M	270749	D	M270749D	Inner	TDI	622
M	270749	TD	M270749TD	Inner	TDIT	632
M	270749		M270749	Inner	TDO	586
M	270749		M270749	Inner	TS	382
M	271610	D	M271610D	Outer	TDO	586
M	271648		M271648	Inner	TDO	586
LM	272210	CD	LM272210CD	Outer	TDO	586

Prefix	Base	Suffix	Part Number Prefix + Base + Suffix	Part Type	Type	Page No.
LM	272210	D	LM272210D	Outer	TDO	586
LM	272210		LM272210	Outer	TDI	624
LM	272210		LM272210	Outer	TS	384
LM	272235		LM272235	Inner	TDO	586
LM	272235		LM272235	Inner	TS	384
LM	272249	D	LM272249D	Inner	TDI	624
LM	272249		LM272249	Inner	TDO	586
LM	272249		LM272249	Inner	TS	384
M	272710	CD	M272710CD	Outer	TDO	586
M	272710	D	M272710D	Outer	TDO	586
M	272710		M272710	Outer	TDI	624
M	272710		M272710	Outer	TDIT	634
M	272710		M272710	Outer	TS	384
M	272749	D	M272749D	Inner	TDI	624
M	272749	TD	M272749TD	Inner	TDIT	634
M	272749		M272749	Inner	TDO	586
M	272749		M272749	Inner	TS	384
M	274110	CD	M274110CD	Outer	TDO	588
M	274110		M274110	Outer	TDI	624
M	274110		M274110	Outer	TDIT	634
M	274110		M274110	Outer	TS	386
M	274147	TD	M274147TD	Inner	TDIT	634
M	274149	D	M274149D	Inner	TDI	624
M	274149	TD	M274149TD	Inner	TDIT	634
M	274149		M274149	Inner	TDO	588
M	274149		M274149	Inner	TS	386
LM	274410		LM274410	Outer	TDI	624
LM	274449	D	LM274449D	Inner	TDI	624
EE	275095		EE275095	Inner	TDO	566
EE	275095		EE275095	Inner	TS	356
EE	275100		EE275100	Inner	TDO	568
EE	275100		EE275100	Inner	TS	358
EE	275100		EE275100	Inner	TSF	486
EE	275105		EE275105	Inner	TDO	570
EE	275105		EE275105	Inner	TS	362
EE	275105		EE275105	Inner	TSF	486
EE	275106	D	EE275106D	Inner	TDI	610
EE	275108		EE275108	Inner	TDO	570
EE	275108		EE275108	Inner	TDO	572
EE	275108		EE275108	Inner	TS	364
EE	275108		EE275108	Inner	TSF	486
EE	275109	D	EE275109D	Inner	TDI	612
	275155		275155	Outer	TDI	610
	275155		275155	Outer	TDI	612
	275155		275155	Outer	TS	356
	275155		275155	Outer	TS	358
	275155		275155	Outer	TS	362
	275155		275155	Outer	TS	364
	275156	CD	275156CD	Outer	TDO	570
	275156	D	275156D	Outer	TDO	566
	275156	D	275156D	Outer	TDO	568
	275156	D	275156D	Outer	TDO	570
	275158	-B	275158-B	Outer	TSF	486
	275158		275158	Outer	TDI	610
	275158		275158	Outer	TDI	612
	275158		275158	Outer	TS	356

Prefix	Base	Suffix	Part Number Prefix + Base + Suffix	Part Type	Type	Page No.
	275158		275158	Outer	TS	358
	275158		275158	Outer	TS	362
	275158		275158	Outer	TS	364
	275160		275160	Outer	TDI	610
	275160		275160	Outer	TS	356
	275160		275160	Outer	TS	358
	275160		275160	Outer	TS	362
	275160		275160	Outer	TS	364
	275161	D	275161D	Outer	TDO	566
	275161	D	275161D	Outer	TDO	568
	275161	D	275161D	Outer	TDO	570
	275161	D	275161D	Outer	TDO	572
M	275310		M275310	Outer	TDI	624
M	275310		M275310	Outer	TDIT	634
M	275348	D	M275348D	Inner	TDI	624
M	275349	D	M275349D	Inner	TDI	624
M	275349	TD	M275349TD	Inner	TDIT	634
M	276410	CD	M276410CD	Outer	TDO	590
M	276410		M276410	Outer	TDI	624
M	276410		M276410	Outer	TS	386
M	276448	D	M276448D	Inner	TDI	624
M	276449	D	M276449D	Inner	TDI	624
M	276449		M276449	Inner	TDO	590
M	276449		M276449	Inner	TS	386
EE	277455		EE277455	Inner	2TS-IM	686
EE	277455		EE277455	Inner	TS	396
X2S-	277455		X2S-277455	Spacer	2TS-IM	686
Y1S-	277565		Y1S-277565	Spacer	2TS-IM	686
	277565		277565	Outer	2TS-IM	686
	277565		277565	Outer	TS	396
M	278710	CD	M278710CD	Outer	TDO	592
M	278710		M278710	Outer	TDI	626
M	278710		M278710	Outer	TDIT	634
M	278710		M278710	Outer	TS	388
M	278748	TD	M278748TD	Inner	TDIT	634
M	278749	D	M278749D	Inner	TDI	626
M	278749		M278749	Inner	TDO	592
M	278749		M278749	Inner	TS	388
LM	278810	CD	LM278810CD	Outer	TDO	592
LM	278810		LM278810	Outer	TDI	626
LM	278848	D	LM278848D	Inner	TDI	626
LM	278849	D	LM278849D	Inner	TDI	626
LM	278849		LM278849	Inner	TDO	592
M	280310		M280310	Outer	TDI	626
M	280349	D	M280349D	Inner	TDI	626
EE	280626		EE280626	Inner	TS	332
EE	280700	D	EE280700D	Inner	TDI	604
LM	281010	CD	LM281010CD	Outer	TDO	594
LM	281010		LM281010	Outer	TS	390
M	281010		M281010	Outer	TDI	626
LM	281049		LM281049	Inner	TDO	594
LM	281049		LM281049	Inner	TS	390
M	281049	D	M281049D	Inner	TDI	626
L	281110	CD	L281110CD	Outer	TDO	594
L	281110		L281110	Outer	TDI	626
L	281110		L281110	Outer	TS	390

Prefix	Base	Suffix	Part Number Prefix + Base + Suffix	Part Type	Type	Page No.
L	281146		L281146	Inner	TS	390
L	281147		L281147	Inner	TDO	594
L	281147		L281147	Inner	TS	390
L	281148		L281148	Inner	TDO	594
L	281148		L281148	Inner	TS	390
L	281149	D	L281149D	Inner	TDI	626
	281200		281200	Outer	TDI	604
	281200		281200	Outer	TS	332
M	281610	CD	M281610CD	Outer	TDO	592
M	281610		M281610	Outer	TS	390
M	281635		M281635	Inner	TDO	592
M	281635		M281635	Inner	TS	390
LM	281810	CD	LM281810CD	Outer	TDO	594
LM	281810		LM281810	Outer	TS	390
LM	281849		LM281849	Inner	TDO	594
LM	281849		LM281849	Inner	TS	390
M	282210	CD	M282210CD	Outer	TDO	594
M	282210		M282210	Outer	TDI	626
M	282210		M282210	Outer	TS	390
M	282249	D	M282249D	Inner	TDI	626
M	282249		M282249	Inner	TDO	594
M	282249		M282249	Inner	TS	390
LM	282510		LM282510	Outer	TDI	626
LM	282549	D	LM282549D	Inner	TDI	626
M	283410		M283410	Outer	TDI	628
M	283449	D	M283449D	Inner	TDI	628
LM	283610	CD	LM283610CD	Outer	TDO	594
LM	283610		LM283610	Outer	TS	392
LM	283649	H	LM283649H	Inner	TS	392
LM	283649		LM283649	Inner	TDO	594
LM	283649		LM283649	Inner	TS	392
M	284210		M284210	Outer	TDI	628
M	284249	D	M284249D	Inner	TDI	628
EE	285160		EE285160	Inner	TDO	582
EE	285160		EE285160	Inner	TS	380
NA	285160		NA285160	Inner	TNA	646
EE	285161	D	EE285161D	Inner	TDI	620
EE	285162		EE285162	Inner	TDO	584
EE	285162		EE285162	Inner	TS	380
	285226		285226	Outer	TDI	620
	285226		285226	Outer	TS	380
	285228	D	285228D	Outer	TDO	582
	285228	D	285228D	Outer	TDO	584
	285228	D	285228D	Outer	TNA	646
M	285810		M285810	Outer	TDI	628
M	285848	D	M285848D	Inner	TDI	628
LM	286210	CD	LM286210CD	Outer	TDO	596
LM	286210		LM286210	Outer	TDI	628
LM	286210		LM286210	Outer	TS	394
LM	286249	AA	LM286249AA	Inner	TDO	596
LM	286249	D	LM286249D	Inner	TDI	628
LM	286249		LM286249	Inner	TS	394
JL	286910		JL286910	Outer	TS	394
JL	286948	H	JL286948H	Inner	TS	394
JL	286948		JL286948	Inner	TS	394
JL	286949	H	JL286949H	Inner	TS	394

TAPERED ROLLER BEARINGS

INDEX

Prefix	Base	Suffix	Part Number Prefix + Base + Suffix	Part Type	Type	Page No.
JL	286949		JL286949	Inner	TS	394
LM	287610		LM287610	Outer	TDI	628
LM	287649	D	LM287649D	Inner	TDI	628
LM	287810		LM287810	Outer	TDI	628
LM	287849	AD	LM287849AD	Inner	TDI	628
LM	287849	D	LM287849D	Inner	TDI	628
LM	288910		LM288910	Outer	TDI	628
LM	288949	D	LM288949D	Inner	TDI	628
EE	291175		EE291175	Inner	TDO	574
EE	291175		EE291175	Inner	TS	368
EE	291175		EE291175	Inner	TSF	488
EE	291176	D	EE291176D	Inner	TDI	614
EE	291200	D	EE291200D	Inner	TDI	614
EE	291201		EE291201	Inner	TDO	574
EE	291201		EE291201	Inner	TS	368
EE	291201		EE291201	Inner	TSF	488
EE	291250		EE291250	Inner	2TS-IM	684
EE	291250		EE291250	Inner	TDO	576
EE	291250		EE291250	Inner	TS	370
EE	291250		EE291250	Inner	TSF	488
X1S-	291250		X1S-291250	Spacer	2TS-IM	684
	291749		291749	Outer	TDI	614
	291749		291749	Outer	TS	368
	291749		291749	Outer	TS	370
Y7S-	291750		Y7S-291750	Spacer	2TS-IM	684
	291750	-B	291750-B	Outer	TSF	488
	291750		291750	Outer	2TS-IM	684
	291750		291750	Outer	TDI	614
	291750		291750	Outer	TS	368
	291750		291750	Outer	TS	370
	291751	CD	291751CD	Outer	TDO	574
	291751	CD	291751CD	Outer	TDO	576
	291753	CD	291753CD	Outer	TDO	574
EE	292548		EE292548	Inner	TDO	596
EE	292550		EE292550	Inner	TDO	596
	292668	CD	292668CD	Outer	TDO	596
	292668	D	292668D	Outer	TDO	596
EE	295102		EE295102	Inner	TDO	570
EE	295102		EE295102	Inner	TS	362
EE	295106	D	EE295106D	Inner	TDI	612
EE	295110		EE295110	Inner	TDO	572
EE	295110		EE295110	Inner	TS	364
	295192	CD	295192CD	Outer	TDO	570
	295192	CD	295192CD	Outer	TDO	572
	295192	D	295192D	Outer	TDO	566
	295192	D	295192D	Outer	TDO	570
	295192	D	295192D	Outer	TDO	572
	295193		295193	Outer	TDI	612
	295193		295193	Outer	TS	356
	295193		295193	Outer	TS	362
	295193		295193	Outer	TS	364
DX	295661		DX295661	Outer	TDO	580
EE	295950		EE295950	Inner	TDO	566
EE	295950		EE295950	Inner	TS	356
EE	299615		EE299615	Inner	2TS-IM	686
EE	299615		EE299615	Inner	TS	396

Prefix	Base	Suffix	Part Number Prefix + Base + Suffix	Part Type	Type	Page No.
X2S-	299615		X2S-299615	Spacer	2TS-IM	686
Y3S-	299711		Y3S-299711	Spacer	2TS-IM	686
	299711	X	299711X	Outer	2TS-IM	686
	299711		299711	Outer	TS	396
LM	300811		LM300811	Outer	TS	162
LM	300848		LM300848	Inner	TS	162
LM	300849		LM300849	Inner	TS	162
K	302667		K302667	Outer	TNASW	650
L	305610	-B	L305610-B	Outer	TSF	450
L	305610	-B	L305610-B	Outer	TSF	454
L	305610	D	L305610D	Outer	TDO	514
L	305610		L305610	Outer	TS	198
L	305610		L305610	Outer	TS	200
L	305611		L305611	Outer	TS	198
L	305648		L305648	Inner	TS	198
L	305648		L305648	Inner	TSF	450
L	305649		L305649	Inner	TDO	514
L	305649		L305649	Inner	TS	200
L	305649		L305649	Inner	TSF	454
DX	307395		DX307395	Outer	TDO	576
H	307710	ER	H307710ER	Spacer	SR	716
H	307710	ES	H307710ES	Spacer	SR	716
JH	307710		JH307710	Outer	SR	716
JH	307710		JH307710	Outer	TS	220
H	307749	XR	H307749XR	Spacer	SR	716
H	307749	XS	H307749XS	Spacer	SR	716
JH	307749		JH307749	Inner	SR	716
JH	307749		JH307749	Inner	TS	220
HM	318410	EA	HM318410EA	Spacer	2TS-DM	696
HM	318410	ES	HM318410ES	Spacer	2TS-IM	670
HM	318410	ES	HM318410ES	Spacer	SR	718
JHM	318410		JHM318410	Outer	2TS-DM	696
JHM	318410		JHM318410	Outer	2TS-IM	670
JHM	318410		JHM318410	Outer	SR	718
JHM	318410		JHM318410	Outer	TS	294
HM	318448	XA	HM318448XA	Spacer	2TS-IM	670
HM	318448	XS	HM318448XS	Spacer	SR	718
JHM	318448		JHM318448	Inner	2TS-DM	696
JHM	318448		JHM318448	Inner	2TS-IM	670
JHM	318448		JHM318448	Inner	SR	718
JHM	318448		JHM318448	Inner	TS	294
L	319210	D	L319210D	Outer	TDO	538
L	319210		L319210	Outer	TS	296
L	319210		L319210	Outer	TS	298
L	319245		L319245	Inner	TS	296
L	319249		L319249	Inner	TDO	538
L	319249		L319249	Inner	TS	298
EE	321145		EE321145	Inner	TS	376
EE	321146	D	EE321146D	Inner	TDI	618
HM	321210	EB	HM321210EB	Spacer	2TS-DM	696
HM	321210		HM321210	Outer	2TS-DM	696
	321240		321240	Outer	TDI	618
	321240		321240	Outer	TS	376
HM	321245		HM321245	Inner	2TS-DM	696
	321245		321245	Outer	TDI	618
	321245		321245	Outer	TS	376

Prefix	Base	Suffix	Part Number Prefix + Base + Suffix	Part Type	Type	Page No.
EE	323166	D	EE323166D	Inner	TDI	620
	323290		323290	Outer	TDI	620
EE	324103	D	EE324103D	Inner	TDI	610
	324160		324160	Outer	TDI	610
EE	325296	D	EE325296D	Inner	TDI	628
	325420		325420	Outer	TDI	628
K	326056	R	K326056R	Spacer	2S	714
K	326057	R	K326057R	Spacer	2S	714
LL	327010		LL327010	Outer	TS	322
LL	327049		LL327049	Inner	TS	322
L	327210	D	L327210D	Outer	TDO	548
L	327210		L327210	Outer	TS	322
EE	327220		EE327220	Inner	TDO	590
EE	327220		EE327220	Inner	TS	388
L	327249		L327249	Inner	TDO	548
L	327249		L327249	Inner	TS	322
M	327349		M327349	Inner	2TS-DM	700
	327355		327355	Outer	TS	388
	327357	D	327357D	Outer	TDO	590
EE	328167	D	EE328167D	Inner	TDI	620
EE	328167		EE328167	Inner	TDO	584
EE	328167		EE328167	Inner	TS	380
EE	328172	D	EE328172D	Inner	TDI	622
	328268	D	328268D	Outer	TDO	584
	328269		328269	Outer	TDI	620
	328269		328269	Outer	TDI	622
	328269		328269	Outer	TS	380
LM	328410		LM328410	Outer	TS	324
LM	328448		LM328448	Inner	TS	324
NA	329115		NA329115	Inner	TNA	646
NA	329116		NA329116	Inner	TNA	646
EE	329117	D	EE329117D	Inner	TDI	614
EE	329118	D	EE329118D	Inner	TDI	612
NA	329120		NA329120	Inner	TNA	646
NA	329121		NA329121	Inner	TNA	646
	329172		329172	Outer	TDI	612
	329172		329172	Outer	TDI	614
	329172		329172	Outer	TDIT	632
	329173	CD	329173CD	Outer	TNA	646
	329176	D	329176D	Outer	TNA	646
EE	330116	D	EE330116D	Inner	TDI	612
	330166		330166	Outer	TDI	612
LM	330410	D	LM330410D	Outer	TDO	552
LM	330410		LM330410	Outer	TS	330
LM	330448		LM330448	Inner	TDO	552
LM	330448		LM330448	Inner	TS	330
EE	333137		EE333137	Inner	TDO	578
EE	333137		EE333137	Inner	TS	374
EE	333137		EE333137	Inner	TSF	488
EE	333140		EE333140	Inner	TDO	580
EE	333140		EE333140	Inner	TS	374
	333197	-B	333197-B	Outer	TSF	488
	333197		333197	Outer	TS	374
	333203	CD	333203CD	Outer	TDO	578
	333203	CD	333203CD	Outer	TDO	580
M	348410		M348410	Outer	TS	356

Prefix	Base	Suffix	Part Number Prefix + Base + Suffix	Part Type	Type	Page No.
M	348449		M348449	Inner	TS	356
M	349510	EA	M349510EA	Spacer	2TS-IM	684
M	349510		M349510	Outer	2TS-IM	684
M	349510		M349510	Outer	TS	360
M	349549	A	M349549A	Inner	TS	360
M	349549	XA	M349549XA	Spacer	2TS-IM	684
M	349549		M349549	Inner	2TS-IM	684
M	349549		M349549	Inner	TS	360
EE	350701		EE350701	Inner	2TS-DM	704
EE	350701		EE350701	Inner	2TS-IM	680
EE	350701		EE350701	Inner	TS	338
X2S-	350701		X2S-350701	Spacer	2TS-IM	680
EE	350750		EE350750	Inner	2TS-DM	706
EE	350750		EE350750	Inner	2TS-IM	682
EE	350750		EE350750	Inner	TS	342
X3S-	350750		X3S-350750	Spacer	2TS-IM	682
Y1S-	351687		Y1S-351687	Spacer	2TS-DM	704
Y1S-	351687		Y1S-351687	Spacer	2TS-DM	706
Y2S-	351687		Y2S-351687	Spacer	2TS-IM	680
Y2S-	351687		Y2S-351687	Spacer	2TS-IM	682
	351687		351687	Outer	2TS-DM	704
	351687		351687	Outer	2TS-DM	706
	351687		351687	Outer	2TS-IM	680
	351687		351687	Outer	2TS-IM	682
	351687		351687	Outer	TS	338
	351687		351687	Outer	TS	342
KLL	352110		KLL352110	Outer	TS	364
LL	352110		LL352110	Outer	TS	364
KLL	352149		KLL352149	Inner	TS	364
LL	352149		LL352149	Inner	TS	364
DX	355312		DX355312	Inner	TDO	580
L	357010	CD	L357010CD	Outer	TDO	574
L	357010	CD	L357010CD	Outer	TNASWE	656
L	357010		L357010	Outer	TS	366
L	357010		L357010	Outer	TS	368
L	357019	-B	L357019-B	Outer	TSF	488
L	357040		L357040	Inner	TS	366
L	357040		L357040	Inner	TSF	488
L	357049	NW	L357049NW	Inner	TNASWE	656
L	357049		L357049	Inner	TDO	574
L	357049		L357049	Inner	TS	368
L	357049		L357049	Inner	TSF	488
NP	357825		NP357825	Outer	TDI	624
NP	360973		NP360973	Outer	TDI	626
LM	361610		LM361610	Outer	TS	372
LM	361649	A	LM361649A	Inner	TS	372
LM	361649		LM361649	Inner	TS	372
LL	365310		LL365310	Outer	TS	378
LL	365348		LL365348	Inner	TS	378
DX	371163		DX371163	Outer	TDO	576
LM	377410	CD	LM377410CD	Outer	TDO	590
LM	377410		LM377410	Outer	2TS-IM	686
LM	377410		LM377410	Outer	TDI	626
LM	377410		LM377410	Outer	TS	388
LM	377448		LM377448	Inner	TDO	590
LM	377449	D	LM377449D	Inner	TDI	626

TAPERED ROLLER BEARINGS

INDEX

Prefix	Base	Suffix	Part Number Prefix + Base + Suffix	Part Type	Type	Page No.
LM	377449	H	LM377449H	Inner	2TS-IM	686
LM	377449	XB	LM377449XB	Spacer	2TS-IM	686
LM	377449		LM377449	Inner	TDO	590
LM	377449		LM377449	Inner	TS	388
NP	378108		NP378108	Inner	2TS-DM	710
EE	380080		EE380080	Inner	2TS-IM	682
EE	380080		EE380080	Inner	TS	344
EE	380081		EE380081	Inner	TS	346
X1S-	380081		X1S-380081	Spacer	2TS-IM	682
Y1S-	380190		Y1S-380190	Spacer	2TS-IM	682
Y2S-	380190		Y2S-380190	Spacer	2TS-DM	706
	380190		380190	Outer	2TS-DM	706
	380190		380190	Outer	2TS-IM	682
	380190		380190	Outer	TS	344
	380190		380190	Outer	TS	346
	380190		380190	Outer	TS	348
LL	380810	-B	LL380810-B	Outer	TSF	490
LL	380849		LL380849	Inner	TSF	490
EE	380875		EE380875	Inner	2TS-DM	706
EE	380875		EE380875	Inner	TS	348
LL	382110		LL382110	Outer	TS	392
LL	382149		LL382149	Inner	TS	392
NP	384818		NP384818	Outer	TS	388
NP	385417		NP385417	Inner	TDI	628
EE	390090		EE390090	Inner	2TS-DM	708
EE	390090		EE390090	Inner	TS	350
EE	390095		EE390095	Inner	TS	356
Y1S-	390200		Y1S-390200	Spacer	2TS-DM	708
	390200		390200	Outer	2TS-DM	708
	390200		390200	Outer	TS	350
	390200		390200	Outer	TS	356
LL	408010	-B	LL408010-B	Outer	TSF	458
LL	408049		LL408049	Inner	TSF	458
H	414210	-B	H414210-B	Outer	TSF	460
H	414210	-B	H414210-B	Outer	TSF	466
H	414210	EA	H414210EA	Spacer	2TS-DM	692
H	414210		H414210	Outer	2TS-DM	692
H	414210		H414210	Outer	TS	246
H	414210		H414210	Outer	TS	254
H	414210		H414210	Outer	TS	258
H	414210		H414210	Outer	TS	266
H	414235		H414235	Inner	TS	246
H	414235		H414235	Inner	TSF	460
H	414236		H414236	Inner	TS	246
H	414242		H414242	Inner	TS	254
H	414245	X	H414245X	Inner	TS	258
H	414249		H414249	Inner	2TS-DM	692
H	414249		H414249	Inner	TS	266
H	414249		H414249	Inner	TSF	466
H	415610	ES	H415610ES	Spacer	SR	718
JH	415610		JH415610	Outer	SR	718
JH	415610		JH415610	Outer	TS	270
H	415647	XS	H415647XS	Spacer	SR	718
JH	415647		JH415647	Inner	SR	718
JH	415647		JH415647	Inner	TS	270
DX	418857		DX418857	Inner	TDO	580

Prefix	Base	Suffix	Part Number Prefix + Base + Suffix	Part Type	Type	Page No.
L	420410		L420410	Outer	TS	306
L	420449		L420449	Inner	TS	306
LL	420510		LL420510	Outer	TS	306
LL	420549		LL420549	Inner	TS	306
EE	420651		EE420651	Inner	TS	334
EE	420701		EE420701	Inner	TS	338
EE	420750	D	EE420750D	Inner	TDI	606
EE	420751		EE420751	Inner	TDO	558
EE	420751		EE420751	Inner	TS	342
EE	420793		EE420793	Inner	TS	344
EE	420800	D	EE420800D	Inner	TDI	606
EE	420801		EE420801	Inner	2TS-DM	706
EE	420801		EE420801	Inner	TDO	560
EE	420801		EE420801	Inner	TS	344
EE	420804	D	EE420804D	Inner	TDI	606
EE	420812	X	EE420812X	Inner	TS	346
EE	420850		EE420850	Inner	TDO	562
EE	420850		EE420850	Inner	TS	348
HH	421210	EB	HH421210EB	Spacer	2TS-DM	696
HH	421210		HH421210	Outer	2TS-DM	696
HH	421210		HH421210	Outer	TS	302
HH	421246	C	HH421246C	Inner	2TS-DM	696
HH	421246	C	HH421246C	Inner	TS	302
	421417		421417	Outer	TS	338
	421417		421417	Outer	TS	342
	421417		421417	Outer	TS	344
	421417		421417	Outer	TS	346
	421417		421417	Outer	TS	348
Y2S-	421437		Y2S-421437	Spacer	2TS-DM	706
	421437		421437	Outer	2TS-DM	706
	421437		421437	Outer	TDI	606
	421437		421437	Outer	TS	334
	421437		421437	Outer	TS	338
	421437		421437	Outer	TS	342
	421437		421437	Outer	TS	344
	421437		421437	Outer	TS	348
	421450		421450	Outer	TDI	606
	421450		421450	Outer	TS	338
	421450		421450	Outer	TS	342
	421450		421450	Outer	TS	344
	421451	CD	421451CD	Outer	TDO	558
	421451	CD	421451CD	Outer	TDO	560
	421462	XD	421462XD	Outer	TDO	562
NP	422278		NP422278	Outer	2S	714
EE	423181	D	EE423181D	Inner	TDI	622
	423300		423300	Outer	TDI	622
EE	424257	D	EE424257D	Inner	TDI	626
	424405		424405	Outer	TDI	626
EE	425176	D	EE425176D	Inner	TDI	622
	425299		425299	Outer	TDI	622
EE	426198	D	EE426198D	Inner	TDI	624
EE	426200		EE426200	Inner	TDO	588
EE	426200		EE426200	Inner	TS	386
	426330		426330	Outer	TDI	624
	426330		426330	Outer	TS	386
	426331	CD	426331CD	Outer	TDO	588

Prefix	Base	Suffix	Part Number Prefix + Base + Suffix	Part Type	Type	Page No.
K	426891	R	K426891R	Spacer	2S	712
K	426892	R	K426892R	Spacer	2S	712
K	426900	R	K426900R	Spacer	2TS-IM	662
EE	428262	D	EE428262D	Inner	TDI	626
LL	428310	EA	LL428310EA	Spacer	2TS-DM	700
LL	428310		LL428310	Outer	2TS-DM	700
LL	428349		LL428349	Inner	2TS-DM	700
	428420		428420	Outer	TDI	626
EE	430888		EE430888	Inner	TDO	562
EE	430888		EE430888	Inner	TS	348
EE	430900		EE430900	Inner	TDO	564
EE	430900		EE430900	Inner	TS	350
EE	430901	D	EE430901D	Inner	TDI	608
	431575		431575	Outer	TDI	608
	431575		431575	Outer	TS	348
	431575		431575	Outer	TS	350
	431576	CD	431576CD	Outer	TDO	562
	431576	CD	431576CD	Outer	TDO	564
L	432310		L432310	Outer	TS	332
L	432348		L432348	Inner	TS	332
H	432510		H432510	Outer	TDI	604
H	432549	D	H432549D	Inner	TDI	604
L	433710		L433710	Outer	TS	332
L	433749		L433749	Inner	TS	332
EE	435102		EE435102	Inner	TDO	568
EE	435102		EE435102	Inner	TDO	570
EE	435102		EE435102	Inner	TS	360
EE	435103	D	EE435103D	Inner	TDI	610
	435165	CD	435165CD	Outer	TDO	568
	435165	D	435165D	Outer	TDO	570
	435165		435165	Outer	TDI	610
	435165		435165	Outer	TS	360
HH	437510	EA	HH437510EA	Spacer	2TS-DM	702
HH	437510		HH437510	Outer	2TS-DM	702
HH	437510		HH437510	Outer	2TS-IM	678
HH	437510		HH437510	Outer	TS	334
HH	437549	XA	HH437549XA	Spacer	2TS-IM	678
HH	437549		HH437549	Inner	2TS-DM	702
HH	437549		HH437549	Inner	2TS-IM	678
HH	437549		HH437549	Inner	TS	334
NP	439444		NP439444	Outer	TDI	628
NP	442420		NP442420	Inner	TDO	596
K	444653	R	K444653R	Snap Ring	SR	716
K	444667	R	K444667R	Spacer	2S	714
K	444668	R	K444668R	Spacer	2S	714
LM	446310	D	LM446310D	Outer	TDO	564
LM	446310	D	LM446310D	Outer	TNASWE	656
LM	446310		LM446310	Outer	TS	352
LM	446349	NW	LM446349NW	Inner	TNASWE	656
LM	446349		LM446349	Inner	TDO	564
LM	446349		LM446349	Inner	TS	352
NP	446605		NP446605	Inner	TNASW	652
EE	450577		EE450577	Inner	TS	328
EE	450601		EE450601	Inner	TDO	554
EE	450601		EE450601	Inner	TS	330
LL	450748	A	LL450748A	Inner	TS	362

Prefix	Base	Suffix	Part Number Prefix + Base + Suffix	Part Type	Type	Page No.
LL	450749	AA	LL450749AA	Inner	TS	362
	451212		451212	Outer	TS	328
	451212		451212	Outer	TS	330
	451215	CD	451215CD	Outer	TDO	554
LM	451310	-B	LM451310-B	Outer	TSF	486
LM	451310	CD	LM451310CD	Outer	TDO	570
LM	451310	EC	LM451310EC	Spacer	2TS-DM	708
LM	451310		LM451310	Outer	2TS-DM	708
LM	451310		LM451310	Outer	TDI	610
LM	451310		LM451310	Outer	TDIT	630
LM	451310		LM451310	Outer	TS	362
LM	451345		LM451345	Inner	TDO	570
LM	451345		LM451345	Inner	TS	362
LM	451347		LM451347	Inner	2TS-DM	708
LM	451347		LM451347	Inner	TS	362
LM	451349	A	LM451349A	Inner	TS	362
LM	451349	AX	LM451349AX	Inner	TS	362
LM	451349	D	LM451349D	Inner	TDI	610
LM	451349	TD	LM451349TD	Inner	TDIT	630
LM	451349		LM451349	Inner	TDO	570
LM	451349		LM451349	Inner	TS	362
LM	451349		LM451349	Inner	TSF	486
HM	456910	CD	HM456910CD	Outer	TDO	572
HM	456949		HM456949	Inner	TDO	572
L	467510	-B	L467510-B	Outer	TSF	490
L	467510		L467510	Outer	2TS-IM	684
L	467510		L467510	Outer	TS	378
L	467549		L467549	Inner	2TS-IM	684
L	467549		L467549	Inner	TS	378
L	467549		L467549	Inner	TSF	490
LL	469910		LL469910	Outer	TS	382
LL	469949		LL469949	Inner	TS	382
EE	470073		EE470073	Inner	TS	338
EE	470075		EE470075	Inner	TS	340
EE	470078	X	EE470078X	Inner	TS	338
	470128		470128	Outer	TS	338
	470128		470128	Outer	TS	340
	470130		470130	Outer	TS	338
Y1S-	470132		Y1S-470132	Spacer	2TS-DM	706
	470132		470132	Outer	2TS-DM	706
	470132		470132	Outer	2TS-IM	682
	470132		470132	Outer	TS	338
	470132		470132	Outer	TS	340
	470975		470975	Inner	2TS-DM	706
	470975		470975	Inner	2TS-IM	682
LL	475010	D	LL475010D	Outer	TDO	590
LL	475011	D	LL475011D	Outer	TDO	590
LL	475048		LL475048	Inner	TDO	590
L	476510	CD	L476510CD	Outer	TDO	590
L	476510		L476510	Outer	TS	386
L	476548		L476548	Inner	TS	386
L	476549		L476549	Inner	TDO	590
L	476549		L476549	Inner	TS	386
EE	480181	D	EE480181D	Inner	TDI	622
	480340		480340	Outer	TDI	622
LL	481411	EB	LL481411EB	Spacer	2TS-IM	686

TAPERED ROLLER BEARINGS

INDEX

Prefix	Base	Suffix	Part Number Prefix + Base + Suffix	Part Type	Type	Page No.
LL	481411		LL481411	Outer	2TS-IM	686
LL	481411		LL481411	Outer	TS	390
LL	481448	XA	LL481448XA	Spacer	2TS-IM	686
LL	481448		LL481448	Inner	2TS-IM	686
LL	481448		LL481448	Inner	TS	390
LL	483418	EA	LL483418EA	Spacer	2TS-IM	686
LL	483418		LL483418	Outer	2TS-IM	686
LL	483418		LL483418	Outer	TS	392
LL	483448		LL483448	Inner	TS	392
LL	483449	XA	LL483449XA	Spacer	2TS-IM	686
LL	483449		LL483449	Inner	2TS-IM	686
LL	483449		LL483449	Inner	TS	392
NP	490062		NP490062	Outer	TDO	566
LM	501310	ES	LM501310ES	Spacer	2TS-IM	660
LM	501310		LM501310	Outer	2TS-IM	660
LM	501310		LM501310	Outer	2S	712
LM	501310		LM501310	Outer	TS	162
LM	501311		LM501311	Outer	TS	162
LM	501314		LM501314	Outer	TS	162
LM	501349	A	LM501349A	Inner	TS	162
LM	501349		LM501349	Inner	2TS-IM	660
LM	501349		LM501349	Inner	2S	712
LM	501349		LM501349	Inner	TS	162
LM	503310		LM503310	Outer	TS	188
LM	503349	A	LM503349A	Inner	TS	188
LM	503349		LM503349	Inner	TS	188
HH	506310		HH506310	Outer	TS	196
HH	506311		HH506311	Outer	TS	196
HH	506311		HH506311	Outer	TS	198
HH	506348		HH506348	Inner	TS	196
HH	506349		HH506349	Inner	TS	198
JLM	506810		JLM506810	Outer	2TS-DM	688
JLM	506810		JLM506810	Outer	2TS-IM	664
JLM	506810		JLM506810	Outer	SR	716
JLM	506810		JLM506810	Outer	TS	220
LM	506810	ES	LM506810ES	Spacer	2TS-IM	664
LM	506810	ES	LM506810ES	Spacer	SR	716
LM	506810	EX	LM506810EX	Spacer	2TS-DM	688
JLM	506811		JLM506811	Outer	TS	220
JLM	506849	A	JLM506849A	Inner	TS	220
JLM	506849		JLM506849	Inner	2TS-DM	688
JLM	506849		JLM506849	Inner	2TS-IM	664
JLM	506849		JLM506849	Inner	SR	716
JLM	506849		JLM506849	Inner	TS	220
LM	506849	XS	LM506849XS	Spacer	SR	716
L	507910	-B	L507910-B	Outer	TSF	458
L	507910		L507910	Outer	TS	214
L	507910		L507910	Outer	TS	224
L	507914	D	L507914D	Outer	TDO	518
L	507945		L507945	Inner	TS	214
L	507949		L507949	Inner	TDO	518
L	507949		L507949	Inner	TS	224
L	507949		L507949	Inner	TSF	458
NP	508551		NP508551	Outer	TDO	596
JLM	508710		JLM508710	Outer	2TS-IM	664
JLM	508710		JLM508710	Outer	SR	716

Prefix	Base	Suffix	Part Number Prefix + Base + Suffix	Part Type	Type	Page No.
JLM	508710		JLM508710	Outer	TS	232
LM	508710	ES	LM508710ES	Spacer	2TS-IM	664
LM	508710	ES	LM508710ES	Spacer	SR	716
JLM	508748		JLM508748	Inner	2TS-IM	664
JLM	508748		JLM508748	Inner	SR	716
JLM	508748		JLM508748	Inner	TS	232
LM	508748	XA	LM508748XA	Spacer	2TS-IM	664
LM	508748	XS	LM508748XS	Spacer	SR	716
LL	510710		LL510710	Outer	TS	240
LL	510749		LL510749	Inner	TS	240
JM	511910		JM511910	Outer	2TS-DM	690
JM	511910		JM511910	Outer	2TS-IM	666
JM	511910		JM511910	Outer	SR	716
JM	511910		JM511910	Outer	TS	248
M	511910	ES	M511910ES	Spacer	2TS-IM	666
M	511910	ES	M511910ES	Spacer	SR	716
JM	511945		JM511945	Inner	TS	248
JM	511946		JM511946	Inner	2TS-DM	690
JM	511946		JM511946	Inner	2TS-IM	666
JM	511946		JM511946	Inner	SR	716
JM	511946		JM511946	Inner	TS	248
M	511946	XA	M511946XA	Spacer	2TS-IM	666
M	511946	XS	M511946XS	Spacer	SR	716
JM	515610		JM515610	Outer	2TS-DM	694
JM	515610		JM515610	Outer	2TS-IM	668
JM	515610		JM515610	Outer	SR	718
JM	515610		JM515610	Outer	TS	280
M	515610	ES	M515610ES	Spacer	2TS-IM	668
M	515610	ES	M515610ES	Spacer	SR	718
JM	515649		JM515649	Inner	2TS-DM	694
JM	515649		JM515649	Inner	2TS-IM	668
JM	515649		JM515649	Inner	SR	718
JM	515649		JM515649	Inner	TS	280
M	515649	XC	M515649XC	Spacer	2TS-IM	668
M	515649	XS	M515649XS	Spacer	SR	718
HM	515714		HM515714	Outer	TS	278
HM	515716		HM515716	Outer	TS	272
HM	515716		HM515716	Outer	TS	278
HM	515745		HM515745	Inner	TS	272
HM	515749		HM515749	Inner	TS	278
HM	516410	A	HM516410A	Outer	TS	280
HM	516410	EA	HM516410EA	Spacer	2TS-DM	694
HM	516410		HM516410	Outer	2TS-DM	694
HM	516410		HM516410	Outer	TS	272
HM	516410		HM516410	Outer	TS	280
HM	516410		HM516410	Outer	TS	282
HM	516442		HM516442	Inner	TS	272
HM	516447		HM516447	Inner	TS	280
HM	516448		HM516448	Inner	TS	282
HM	516449	A	HM516449A	Inner	TS	282
HM	516449	C	HM516449C	Inner	2TS-DM	694
HM	516449	C	HM516449C	Inner	TS	282
K	516778	R	K516778R	Snap Ring	SR	716
K	516800	R	K516800R	Snap Ring	SR	718
HM	516810	EB	HM516810EB	Spacer	SR	718
HM	516810	ES	HM516810ES	Spacer	2TS-IM	670

Prefix	Base	Suffix	Part Number Prefix + Base + Suffix	Part Type	Type	Page No.
HM	516810	ES	HM516810ES	Spacer	SR	718
JHM	516810		JHM516810	Outer	2TS-IM	670
JHM	516810		JHM516810	Outer	SR	718
JHM	516810		JHM516810	Outer	TS	286
HM	516849	XB	HM516849XB	Spacer	SR	718
HM	516849	XS	HM516849XS	Spacer	SR	718
JHM	516849		JHM516849	Inner	2TS-IM	670
JHM	516849		JHM516849	Inner	SR	718
JHM	516849		JHM516849	Inner	TS	286
K	518333	R	K518333R	Snap Ring	SR	718
K	518334	R	K518334R	Snap Ring	SR	718
K	518335	R	K518335R	Snap Ring	SR	720
HM	518410		HM518410	Outer	TS	292
K	518419	R	K518419R	Snap Ring	SR	716
HM	518445		HM518445	Inner	TS	292
K	518771	R	K518771R	Snap Ring	SR	716
K	518771	R	K518771R	Snap Ring	SR	718
K	518773	R	K518773R	Snap Ring	SR	718
K	518779	R	K518779R	Snap Ring	SR	716
K	518781	R	K518781R	Snap Ring	SR	716
LM	520310	D	LM520310D	Outer	TDO	542
LM	520349		LM520349	Inner	TDO	542
LL	521810		LL521810	Outer	TS	308
LL	521810		LL521810	Outer	TS	310
LL	521811	EA	LL521811EA	Spacer	2TS-IM	672
LL	521811		LL521811	Outer	2TS-IM	672
LL	521845		LL521845	Inner	TS	308
LL	521849	C	LL521849C	Inner	2TS-IM	672
LL	521849	C	LL521849C	Inner	TS	310
LL	521849	XB	LL521849XB	Spacer	2TS-IM	672
L	521910	D	L521910D	Outer	TDO	540
L	521910	D	L521910D	Outer	TDO	544
L	521910		L521910	Outer	TS	306
L	521910		L521910	Outer	TS	310
L	521914		L521914	Outer	TS	306
L	521914		L521914	Outer	TS	310
L	521945		L521945	Inner	TDO	540
L	521945		L521945	Inner	TS	306
L	521949		L521949	Inner	TDO	544
L	521949		L521949	Inner	TS	310
EE	522102		EE522102	Inner	TDO	590
EE	522102		EE522102	Inner	TS	386
EE	522126	D	EE522126D	Inner	TDI	624
LM	522510	D	LM522510D	Outer	TDO	544
LM	522510		LM522510	Outer	2TS-IM	672
LM	522510		LM522510	Outer	TS	310
LM	522510		LM522510	Outer	TS	312
LM	522546		LM522546	Inner	TDO	544
LM	522546		LM522546	Inner	TS	310
LM	522548		LM522548	Inner	2TS-IM	672
LM	522548		LM522548	Inner	TDO	544
LM	522548		LM522548	Inner	TS	312
LM	522549	XA	LM522549XA	Spacer	2TS-IM	672
LM	522549		LM522549	Inner	TDO	544
LM	522549		LM522549	Inner	TS	312
HM	522610	ES	HM522610ES	Spacer	2TS-IM	672

Prefix	Base	Suffix	Part Number Prefix + Base + Suffix	Part Type	Type	Page No.
HM	522610	ES	HM522610ES	Spacer	SR	718
JHM	522610		JHM522610	Outer	2TS-IM	672
JHM	522610		JHM522610	Outer	SR	718
JHM	522610		JHM522610	Outer	TS	312
HM	522649	XA	HM522649XA	Spacer	2TS-IM	672
HM	522649	XE	HM522649XE	Spacer	SR	718
HM	522649	XS	HM522649XS	Spacer	SR	718
JHM	522649	A	JHM522649A	Inner	TS	312
JHM	522649	AC	JHM522649AC	Inner	2TS-IM	672
JHM	522649		JHM522649	Inner	2TS-IM	672
JHM	522649		JHM522649	Inner	SR	718
	523087		523087	Outer	TDI	624
	523087		523087	Outer	TS	386
	523088	D	523088D	Outer	TDO	590
K	523966	R	K523966R	Spacer	2TS-IM	660
K	523970	R	K523970R	Snap Ring	SR	718
K	524105	R	K524105R	Snap Ring	SR	716
K	524112	R	K524112R	Snap Ring	SR	718
K	524653	R	K524653R	Snap Ring	SR	718
K	524660	R	K524660R	Snap Ring	SR	718
K	524667	R	K524667R	Spacer	2S	712
EE	525183	D	EE525183D	Inner	TDI	622
	525320		525320	Outer	TDI	622
K	525362	R	K525362R	Snap Ring	SR	718
K	525377	R	K525377R	Snap Ring	SR	720
K	525378	R	K525378R	Snap Ring	SR	720
EE	526130		EE526130	Inner	TDO	576
EE	526130		EE526130	Inner	TS	372
EE	526130		EE526130	Inner	TSF	488
EE	526131	D	EE526131D	Inner	TDI	616
EE	526132		EE526132	Inner	TDO	576
EE	526132		EE526132	Inner	TS	372
	526190	-B	526190-B	Outer	TSF	488
	526190		526190	Outer	TDI	616
	526190		526190	Outer	TS	372
	526190		526190	Outer	TS	372
	526191	CD	526191CD	Outer	TDO	576
	526191	D	526191D	Outer	TDO	576
K	527327	R	K527327R	Snap Ring	SR	716
K	527332	R	K527332R	Snap Ring	SR	718
K	528895	R	K528895R	Spacer	2S	712
LL	529710		LL529710	Outer	TS	326
LL	529749		LL529749	Inner	TS	326
EE	531201	D	EE531201D	Inner	TDI	624
	531300		531300	Outer	TDI	624
HM	534110	EB	HM534110EB	Spacer	2TS-DM	704
HM	534110	ES	HM534110ES	Spacer	2TS-IM	678
JHM	534110		JHM534110	Outer	2TS-DM	704
JHM	534110		JHM534110	Outer	2TS-IM	678
JHM	534110		JHM534110	Outer	TS	334
HM	534149	XA	HM534149XA	Spacer	2TS-IM	678
JHM	534149		JHM534149	Inner	2TS-DM	704
JHM	534149		JHM534149	Inner	2TS-IM	678
JHM	534149		JHM534149	Inner	TS	334
HM	535310	-B	HM535310-B	Outer	TSF	484
HM	535310	EA	HM535310EA	Spacer	2TS-DM	704
HM	535310	EE	HM535310EE	Spacer	2TS-IM	680

TAPERED ROLLER BEARINGS

INDEX

Prefix	Base	Suffix	Part Number Prefix + Base + Suffix	Part Type	Type	Page No.
HM	535310	ES	HM535310ES	Spacer	2TS-IM	678
HM	535310	EW	HM535310EW	Spacer	2TS-IM	680
HM	535310	EX	HM535310EX	Spacer	2TS-IM	680
HM	535310		HM535310	Outer	2TS-DM	704
HM	535310		HM535310	Outer	2TS-IM	678
HM	535310		HM535310	Outer	2TS-IM	680
HM	535310		HM535310	Outer	TS	336
HM	535347	XA	HM535347XA	Spacer	2TS-IM	678
HM	535347		HM535347	Inner	2TS-DM	704
HM	535347		HM535347	Inner	2TS-IM	678
HM	535349	XB	HM535349XB	Spacer	2TS-IM	680
HM	535349	XE	HM535349XE	Spacer	2TS-IM	680
HM	535349	XS	HM535349XS	Spacer	2TS-IM	680
HM	535349		HM535349	Inner	2TS-IM	680
HM	535349		HM535349	Inner	TS	336
HM	535349		HM535349	Inner	TSF	484
NA	537075		NA537075	Inner	TNA	646
	537103	D	537103D	Outer	TNA	646
LL	537610		LL537610	Outer	TS	338
LL	537649		LL537649	Inner	TS	338
EE	538260		EE538260	Inner	TS	390
EE	538261		EE538261	Inner	TS	390
	538370		538370	Outer	TS	390
L	540010	EA	L540010EA	Spacer	2TS-DM	706
L	540010		L540010	Outer	2TS-DM	706
L	540049		L540049	Inner	2TS-DM	706
M	541310	CD	M541310CD	Outer	TDO	558
M	541349		M541349	Inner	TDO	558
EE	542215		EE542215	Inner	TDO	590
EE	542215		EE542215	Inner	TS	386
EE	542220		EE542220	Inner	TDO	590
EE	542220		EE542220	Inner	TS	386
	542290		542290	Outer	TS	386
	542291	CD	542291CD	Outer	TDO	590
	543085		543085	Inner	2TS-DM	706
	543085		543085	Inner	TDO	562
	543085		543085	Inner	TS	348
	543086		543086	Inner	TDO	562
	543086		543086	Inner	TS	348
Y2S-	543114		Y2S-543114	Spacer	2TS-DM	706
	543114		543114	Outer	2TS-DM	706
	543114		543114	Outer	TS	348
	543115	D	543115D	Outer	TDO	562
	543116		543116	Outer	TS	348
NP	543910		NP543910	Outer	TS	386
X1S-	544090		X1S-544090	Spacer	2TS-IM	682
	544090		544090	Inner	2TS-DM	708
	544090		544090	Inner	2TS-IM	682
	544090		544090	Inner	TS	350
	544091		544091	Inner	TS	352
	544116		544116	Outer	TS	350
	544116		544116	Outer	TS	352
Y3S-	544118		Y3S-544118	Spacer	2TS-IM	682
Y4S-	544118		Y4S-544118	Spacer	2TS-DM	708
	544118		544118	Outer	2TS-DM	708
	544118		544118	Outer	2TS-IM	682

Prefix	Base	Suffix	Part Number Prefix + Base + Suffix	Part Type	Type	Page No.
	544118		544118	Outer	TS	350
	544118		544118	Outer	TS	352
NP	544119		NP544119	Inner	TS	356
	545112		545112	Inner	2TS-DM	708
	545112		545112	Inner	TDO	572
	545112		545112	Inner	TS	366
	545139		545139	Outer	TS	366
Y2S-	545141		Y2S-545141	Spacer	2TS-DM	708
	545141		545141	Outer	2TS-DM	708
	545141		545141	Outer	TS	366
	545142	CD	545142CD	Outer	TDO	572
LM	545810		LM545810	Outer	TS	352
LM	545812		LM545812	Outer	TS	352
LM	545847		LM545847	Inner	TS	352
LM	545849	A	LM545849A	Inner	TS	352
LM	545849	E	LM545849E	Inner	TS	352
LM	545849		LM545849	Inner	TS	352
EE	546220	D	EE546220D	Inner	TDI	624
	546355		546355	Outer	TDI	624
EE	547341	D	EE547341D	Inner	TDI	628
NP	547476		NP547476	Outer	TDO	592
	547480		547480	Outer	TDI	628
NP	552714		NP552714	Thrust	TTHDFL	729
L	555210	D	L555210D	Outer	TDO	572
L	555210		L555210	Outer	TS	364
L	555210		L555210	Outer	TS	366
L	555233		L555233	Inner	TDO	572
L	555233		L555233	Inner	TS	364
L	555249		L555249	Inner	TS	366
L	558510		L558510	Outer	TS	370
L	558548		L558548	Inner	TS	370
LM	559010		LM559010	Outer	TS	370
LM	559048		LM559048	Inner	TS	370
NP	562053		NP562053	Outer	2TS-DM	710
LL	562710	EB	LL562710EB	Spacer	2TS-IM	684
LL	562710		LL562710	Outer	2TS-IM	684
LL	562710		LL562710	Outer	TS	376
LL	562749	XB	LL562749XB	Spacer	2TS-IM	684
LL	562749		LL562749	Inner	2TS-IM	684
LL	562749		LL562749	Inner	TS	376
LM	565910	-B	LM565910-B	Outer	TSF	488
LM	565910	-B	LM565910-B	Outer	TSF	490
LM	565910		LM565910	Outer	TS	376
LM	565943		LM565943	Inner	TS	376
LM	565943		LM565943	Inner	TSF	488
LM	565946		LM565946	Inner	TS	376
LM	565946		LM565946	Inner	TSF	490
LM	565949		LM565949	Inner	TS	376
LM	565949		LM565949	Inner	TSF	490
LL	566810	-B	LL566810-B	Outer	TSF	490
LL	566810		LL566810	Outer	TS	378
LL	566848		LL566848	Inner	TS	378
LL	566848		LL566848	Inner	TSF	490
LM	567910	-B	LM567910-B	Outer	TSF	490
LM	567910	EA	LM567910EA	Spacer	2TS-DM	710
LM	567910		LM567910	Outer	2TS-DM	710

Prefix	Base	Suffix	Part Number Prefix + Base + Suffix	Part Type	Type	Page No.
LM	567910		LM567910	Outer	TS	378
LM	567943		LM567943	Inner	TSF	490
LM	567949		LM567949	Inner	2TS-DM	710
LM	567949		LM567949	Inner	TS	378
LM	567949		LM567949	Inner	TSF	490
L	570610		L570610	Outer	TS	382
L	570648		L570648	Inner	TS	382
L	570649		L570649	Inner	TS	382
EE	571602		EE571602	Inner	TDO	584
EE	571602		EE571602	Inner	TS	380
EE	571703		EE571703	Inner	TDO	584
EE	571703		EE571703	Inner	TS	382
	572650		572650	Outer	TS	380
	572650		572650	Outer	TS	382
	572651	CD	572651CD	Outer	TDO	584
	572651	D	572651D	Outer	TDO	584
LL	575310	EA	LL575310EA	Spacer	2TS-IM	686
LL	575310		LL575310	Outer	2TS-IM	686
LL	575310		LL575310	Outer	TS	386
LL	575343		LL575343	Inner	TS	386
LL	575349	XA	LL575349XA	Spacer	2TS-IM	686
LL	575349		LL575349	Inner	2TS-IM	686
LL	575349		LL575349	Inner	TS	386
NP	578395		NP578395	Inner	TDO	596
LL	579710	D	LL579710D	Outer	TDO	592
LL	579749		LL579749	Inner	TDO	592
L	580010		L580010	Outer	TS	388
LL	580010		LL580010	Outer	TS	390
L	580049		L580049	Inner	TS	388
LL	580049		LL580049	Inner	TS	390
JL	580914		JL580914	Outer	TS	390
JL	580946		JL580946	Inner	TS	390
LL	582910	-B	LL582910-B	Outer	TSF	492
LL	582910		LL582910	Outer	2TS-IM	686
LL	582910		LL582910	Outer	TS	392
LL	582949		LL582949	Inner	2TS-IM	686
LL	582949		LL582949	Inner	TS	392
LL	582949		LL582949	Inner	TSF	492
LL	584410		LL584410	Outer	TS	392
LL	584449		LL584449	Inner	TS	392
NP	585761		NP585761	Outer	TDO	590
NP	588721		NP588721	Outer	2TS-DM	710
DX	596094		DX596094	Inner	TDO	562
LM	603011	EX	LM603011EX	Spacer	2TS-IM	662
LM	603011		LM603011	Outer	2TS-IM	662
LM	603011		LM603011	Outer	2S	714
LM	603011		LM603011	Outer	TS	188
LM	603012		LM603012	Outer	TS	188
LM	603014		LM603014	Outer	TS	188
LM	603015		LM603015	Outer	TS	188
LM	603049	AS	LM603049AS	Inner	2S	714
LM	603049	AS	LM603049AS	Inner	TS	188
LM	603049	XB	LM603049XB	Spacer	2TS-IM	662
LM	603049	XF	LM603049XF	Spacer	2TS-IM	662
LM	603049		LM603049	Inner	2TS-IM	662
LM	603049		LM603049	Inner	TS	188

Prefix	Base	Suffix	Part Number Prefix + Base + Suffix	Part Type	Type	Page No.
EE	607070		EE607070	Inner	2TS-DM	704
EE	607070		EE607070	Inner	2TS-IM	680
X2S-	607070		X2S-607070	Spacer	2TS-IM	680
Y1S-	607140		Y1S-607140	Spacer	2TS-DM	704
Y4S-	607140		Y4S-607140	Spacer	2TS-IM	680
	607140		607140	Outer	2TS-DM	704
	607140		607140	Outer	2TS-IM	680
NP	609202		NP609202	Inner	TDI	624
L	610510	D	L610510D	Outer	TDO	522
L	610510		L610510	Outer	TS	240
L	610549		L610549	Inner	TDO	522
L	610549		L610549	Inner	TS	240
JM	612910		JM612910	Outer	2TS-IM	668
JM	612910		JM612910	Outer	SR	716
JM	612910		JM612910	Outer	TS	262
M	612910	EA	M612910EA	Spacer	2TS-DM	692
M	612910	ES	M612910ES	Spacer	2TS-IM	668
M	612910	ES	M612910ES	Spacer	SR	716
JM	612949		JM612949	Inner	2TS-IM	668
JM	612949		JM612949	Inner	SR	716
JM	612949		JM612949	Inner	TS	262
M	612949	XA	M612949XA	Spacer	2TS-IM	668
M	612949	XS	M612949XS	Spacer	SR	716
LM	613410	-B	LM613410-B	Outer	TSF	464
LM	613410		LM613410	Outer	TS	258
LM	613449		LM613449	Inner	TS	258
LM	613449		LM613449	Inner	TSF	464
HM	617010		HM617010	Outer	TS	282
HM	617010		HM617010	Outer	TS	288
HM	617045		HM617045	Inner	TS	282
HM	617048		HM617048	Inner	TS	288
HM	617049		HM617049	Inner	TS	288
EE	620100		EE620100	Inner	2TS-DM	708
EE	620100		EE620100	Inner	TS	360
Y1S-	620220		Y1S-620220	Spacer	2TS-DM	708
	620220		620220	Outer	2TS-DM	708
	620220		620220	Outer	TS	360
L	623110	EA	L623110EA	Spacer	2TS-IM	672
L	623110		L623110	Outer	2TS-IM	672
L	623110		L623110	Outer	TS	312
L	623149	XB	L623149XB	Spacer	2TS-IM	672
L	623149		L623149	Inner	2TS-IM	672
L	623149		L623149	Inner	TS	312
L	624510	-B	L624510-B	Outer	TSF	480
L	624510	EE	L624510EE	Spacer	2TS-IM	674
L	624510		L624510	Outer	2TS-IM	674
L	624514	D	L624514D	Outer	TDO	546
L	624514		L624514	Outer	TS	316
L	624549	XS	L624549XS	Spacer	2TS-IM	674
L	624549		L624549	Inner	2TS-IM	674
L	624549		L624549	Inner	TDO	546
L	624549		L624549	Inner	TS	316
L	624549		L624549	Inner	TSF	480
JM	624610	-B	JM624610-B	Outer	TSF	478
JM	624610		JM624610	Outer	TS	316
JM	624649		JM624649	Inner	TS	316

TAPERED ROLLER BEARINGS

INDEX

Prefix	Base	Suffix	Part Number Prefix + Base + Suffix	Part Type	Type	Page No.
JM	624649		JM624649	Inner	TSF	478
HM	624710		HM624710	Outer	TS	316
HM	624716	EA	HM624716EA	Spacer	2TS-DM	698
HM	624716		HM624716	Outer	2TS-DM	698
HM	624716		HM624716	Outer	TS	316
HM	624749		HM624749	Inner	2TS-DM	698
HM	624749		HM624749	Inner	TS	316
EE	626210		EE626210	Inner	TDO	590
	626321	CD	626321CD	Outer	TDO	590
	626321	D	626321D	Outer	TDO	590
EE	627260	D	EE627260D	Inner	TDI	626
	627435		627435	Outer	TDI	626
L	630310	-B	L630310-B	Outer	TSF	482
L	630310		L630310	Outer	TS	330
L	630349		L630349	Inner	TS	330
L	630349		L630349	Inner	TSF	482
EE	631307	D	EE631307D	Inner	TDI	628
EE	631311	D	EE631311D	Inner	TDI	628
	631480		631480	Outer	TDI	628
	631484		631484	Outer	TDI	628
NP	633856		NP633856	Inner	TNASW	652
EE	634356	D	EE634356D	Inner	TDI	628
	634510		634510	Outer	TDI	628
LM	637310	D	LM637310D	Outer	TNASWE	656
LM	637349	NW	LM637349NW	Inner	TNASWE	656
EE	640191		EE640191	Inner	TDO	588
EE	640191		EE640191	Inner	TS	384
EE	640192		EE640192	Inner	TDO	588
EE	640192		EE640192	Inner	TS	384
EE	640192		EE640192	Inner	TSF	490
EE	640193	D	EE640193D	Inner	TDI	624
	640260	-B	640260-B	Outer	TSF	490
	640260		640260	Outer	TDI	624
	640260		640260	Outer	TS	384
	640261	CD	640261CD	Outer	TDO	588
	640261	XD	640261XD	Outer	TDO	588
	640262	D	640262D	Outer	TDO	588
LL	641110		LL641110	Outer	TS	344
LL	641110		LL641110	Outer	TS	346
LL	641149	A	LL641149A	Inner	TS	346
LL	641149		LL641149	Inner	TS	344
DX	641856		DX641856	Inner	TDO	560
EE	647220		EE647220	Inner	TS	386
	647285		647285	Outer	TS	386
LL	648415	-B	LL648415-B	Outer	TSF	486
LL	648415		LL648415	Outer	TS	356
LL	648415		LL648415	Outer	TS	358
LL	648416		LL648416	Outer	TS	358
LL	648434		LL648434	Inner	TS	356
LL	648449		LL648449	Inner	TS	358
LL	648449		LL648449	Inner	TSF	486
EE	649236	X	EE649236X	Inner	TDO	592
EE	649237		EE649237	Inner	TDO	592
EE	649237		EE649237	Inner	TS	388
EE	649238		EE649238	Inner	TS	388
EE	649239		EE649239	Inner	TDO	592

Prefix	Base	Suffix	Part Number Prefix + Base + Suffix	Part Type	Type	Page No.
EE	649239		EE649239	Inner	TS	388
EE	649240	H	EE649240H	Inner	TDO	592
EE	649240	H	EE649240H	Inner	TS	388
EE	649240		EE649240	Inner	TDO	592
EE	649240		EE649240	Inner	TS	388
EE	649241	D	EE649241D	Inner	TDI	626
	649310		649310	Outer	TDI	626
	649310		649310	Outer	TS	388
	649311	CD	649311CD	Outer	TDO	592
	649313	D	649313D	Outer	TDO	592
EE	650170		EE650170	Inner	TDO	584
EE	650170		EE650170	Inner	TS	382
EE	650171	D	EE650171D	Inner	TDI	622
	650270	D	650270D	Outer	TDO	584
	650270		650270	Outer	TDI	622
	650270		650270	Outer	TS	382
NP	652808		NP652808	Outer	TDI	624
LM	654610	-B	LM654610-B	Outer	TSF	488
LM	654610	CD	LM654610CD	Outer	TDO	572
LM	654610		LM654610	Outer	TDI	612
LM	654610		LM654610	Outer	TS	366
LM	654611	EA	LM654611EA	Spacer	2TS-IM	684
LM	654611		LM654611	Outer	2TS-IM	684
LM	654611		LM654611	Outer	TS	364
LM	654642	XA	LM654642XA	Spacer	2TS-IM	684
LM	654642		LM654642	Inner	2TS-IM	684
LM	654642		LM654642	Inner	TDO	572
LM	654642		LM654642	Inner	TS	364
LM	654644	D	LM654644D	Inner	TDI	612
LM	654649		LM654649	Inner	TDO	572
LM	654649		LM654649	Inner	TS	366
LM	654649		LM654649	Inner	TSF	488
EE	655270		EE655270	Inner	TDO	594
EE	655270		EE655270	Inner	TS	392
	655345		655345	Outer	TS	392
	655346	CD	655346CD	Outer	TDO	594
NP	655864		NP655864	Inner	2TS-IM	676
LL	660711		LL660711	Outer	TS	372
LL	660749	A	LL660749A	Inner	TS	372
EE	662303		EE662303	Inner	TDO	592
EE	662303		EE662303	Inner	TS	388
	663550		663550	Outer	TS	388
	663551	CD	663551CD	Outer	TDO	592
	663551	D	663551D	Outer	TDO	592
LM	665910	CD	LM665910CD	Outer	TDO	582
LM	665910		LM665910	Outer	TS	378
LM	665949	A	LM665949A	Inner	TDO	582
LM	665949		LM665949	Inner	TDO	582
LM	665949		LM665949	Inner	TS	378
M	667911	D	M667911D	Outer	TDO	582
M	667911		M667911	Outer	TDI	620
M	667911		M667911	Outer	TS	378
M	667911		M667911	Outer	TS	380
M	667935		M667935	Inner	TDO	582
M	667935		M667935	Inner	TS	378
M	667944		M667944	Inner	TDO	582

Prefix	Base	Suffix	Part Number Prefix + Base + Suffix	Part Type	Type	Page No.
M	667944		M667944	Inner	TS	378
M	667947	D	M667947D	Inner	TDI	620
M	667948		M667948	Inner	TS	380
LL	669810	XD	LL669810XD	Outer	TDO	586
LL	669849		LL669849	Inner	TDO	586
EE	671798	D	EE671798D	Inner	TDI	622
EE	671801		EE671801	Inner	TDO	586
EE	671801		EE671801	Inner	TS	384
	672873		672873	Outer	TDI	622
	672873		672873	Outer	TS	384
	672875	D	672875D	Outer	TDO	586
NP	676901		NP676901	Outer	2TS-DM	710
	680235		680235	Inner	TS	388
	680235		680235	Inner	TSF	490
	680270	-B	680270-B	Outer	TSF	490
	680270		680270	Outer	TS	388
LL	686910	D	LL686910D	Outer	TDO	596
LL	686947		LL686947	Inner	TDO	596
LL	687910	D	LL687910D	Outer	TDO	596
LL	687910		LL687910	Outer	TS	394
LL	687949		LL687949	Inner	TDO	596
LL	687949		LL687949	Inner	TS	394
NP	689200		NP689200	Inner	TDI	626
EE	690296	D	EE690296D	Inner	TDI	628
	690465		690465	Outer	TDI	628
EE	700090	D	EE700090D	Inner	TDI	608
EE	700091		EE700091	Inner	TDO	564
EE	700091		EE700091	Inner	TS	350
	700167		700167	Outer	TDI	608
	700167		700167	Outer	TS	350
	700168	D	700168D	Outer	TDO	564
JLM	704610		JLM704610	Outer	TS	198
JLM	704649		JLM704649	Inner	TS	198
NP	710048		NP710048	Inner	TDI	622
EE	710905		EE710905	Inner	TS	348
EE	710906		EE710906	Inner	TS	350
JLM	710910		JLM710910	Outer	2TS-DM	690
JLM	710910		JLM710910	Outer	2TS-IM	664
JLM	710910		JLM710910	Outer	2TS-IM	666
JLM	710910		JLM710910	Outer	SR	716
JLM	710910		JLM710910	Outer	TS	248
LM	710910	ES	LM710910ES	Spacer	2TS-IM	664
LM	710910	ES	LM710910ES	Spacer	SR	716
JLM	710949	C	JLM710949C	Inner	2TS-DM	690
JLM	710949	C	JLM710949C	Inner	2TS-IM	664
JLM	710949	C	JLM710949C	Inner	2TS-IM	666
JLM	710949	C	JLM710949C	Inner	SR	716
JLM	710949	C	JLM710949C	Inner	TS	248
LM	710949	XA	LM710949XA	Spacer	2TS-IM	664
LM	710949	XS	LM710949XS	Spacer	SR	716
	711600		711600	Outer	TS	348
	711600		711600	Outer	TS	350
L	713010		L713010	Outer	TS	258
LL	713010		LL713010	Outer	TS	258
L	713049		L713049	Inner	TS	258
LL	713049		LL713049	Inner	TS	258

Prefix	Base	Suffix	Part Number Prefix + Base + Suffix	Part Type	Type	Page No.
LL	713110		LL713110	Outer	TS	258
LL	713149		LL713149	Inner	TS	258
JLM	714110		JLM714110	Outer	2TS-DM	692
JLM	714110		JLM714110	Outer	2TS-IM	668
JLM	714110		JLM714110	Outer	SR	716
JLM	714110		JLM714110	Outer	TS	270
LM	714110	EA	LM714110EA	Spacer	2TS-IM	668
LM	714110	ES	LM714110ES	Spacer	2TS-IM	668
LM	714110	ES	LM714110ES	Spacer	SR	716
JLM	714149		JLM714149	Inner	2TS-DM	692
JLM	714149		JLM714149	Inner	2TS-IM	668
JLM	714149		JLM714149	Inner	SR	716
JLM	714149		JLM714149	Inner	TS	270
LM	714149	XA	LM714149XA	Spacer	2TS-IM	668
LM	714149	XB	LM714149XB	Spacer	2TS-IM	668
LM	714149	XS	LM714149XS	Spacer	SR	716
JM	714210		JM714210	Outer	SR	718
JM	714210		JM714210	Outer	TS	270
M	714210	ES	M714210ES	Spacer	SR	718
JM	714249	A	JM714249A	Inner	TS	270
JM	714249		JM714249	Inner	SR	718
JM	714249		JM714249	Inner	TS	270
M	714249	XS	M714249XS	Spacer	SR	718
LL	714610		LL714610	Outer	TS	270
LL	714649		LL714649	Inner	TS	270
H	715310	-B	H715310-B	Outer	TSF	462
H	715310	-B	H715310-B	Outer	TSF	466
H	715310		H715310	Outer	TS	236
H	715310		H715310	Outer	TS	238
H	715310		H715310	Outer	TS	246
H	715310		H715310	Outer	TS	248
H	715310		H715310	Outer	TS	254
H	715310		H715310	Outer	TS	258
H	715310		H715310	Outer	TS	260
H	715310		H715310	Outer	TS	266
H	715310		H715310	Outer	TS	272
H	715310		H715310	Outer	TS	276
H	715311	A	H715311A	Outer	TS	254
H	715311	EA	H715311EA	Spacer	2TS-IM	666
H	715311	EB	H715311EB	Spacer	2TS-IM	666
H	715311	EE	H715311EE	Spacer	2TS-DM	692
H	715311		H715311	Outer	2TS-DM	692
H	715311		H715311	Outer	2TS-IM	666
H	715311		H715311	Outer	TS	236
H	715311		H715311	Outer	TS	238
H	715311		H715311	Outer	TS	246
H	715311		H715311	Outer	TS	248
H	715311		H715311	Outer	TS	254
H	715311		H715311	Outer	TS	258
H	715311		H715311	Outer	TS	262
H	715311		H715311	Outer	TS	266
H	715311		H715311	Outer	TS	272
H	715311		H715311	Outer	TS	276
H	715332		H715332	Inner	TS	236
H	715334		H715334	Inner	TS	238
H	715336		H715336	Inner	TS	246

TAPERED ROLLER BEARINGS

INDEX

Prefix	Base	Suffix	Part Number Prefix + Base + Suffix	Part Type	Type	Page No.
H	715340	XA	H715340XA	Spacer	2TS-IM	666
H	715340	XB	H715340XB	Spacer	2TS-IM	666
H	715340		H715340	Inner	2TS-IM	666
H	715340		H715340	Inner	TS	248
H	715341	A	H715341A	Inner	TS	254
H	715341	XA	H715341XA	Spacer	2TS-IM	666
H	715341		H715341	Inner	2TS-IM	666
H	715341		H715341	Inner	TS	254
H	715341		H715341	Inner	TSF	462
H	715343		H715343	Inner	TS	258
H	715344		H715344	Inner	TS	260
H	715345		H715345	Inner	TS	266
H	715345		H715345	Inner	TSF	466
H	715346		H715346	Inner	TS	272
H	715347		H715347	Inner	2TS-DM	692
H	715347		H715347	Inner	TS	262
H	715348		H715348	Inner	TS	276
JM	716610	-B	JM716610-B	Outer	TSF	470
JM	716610		JM716610	Outer	2TS-DM	694
JM	716610		JM716610	Outer	2TS-IM	670
JM	716610		JM716610	Outer	SR	718
JM	716610		JM716610	Outer	TS	286
M	716610	EB	M716610EB	Spacer	2TS-DM	694
M	716610	ES	M716610ES	Spacer	2TS-IM	670
M	716610	ES	M716610ES	Spacer	SR	718
JM	716648		JM716648	Inner	TS	286
JM	716649		JM716649	Inner	2TS-DM	694
JM	716649		JM716649	Inner	2TS-IM	670
JM	716649		JM716649	Inner	SR	718
JM	716649		JM716649	Inner	TS	286
JM	716649		JM716649	Inner	TSF	470
M	716649	XB	M716649XB	Spacer	2TS-IM	670
M	716649	XS	M716649XS	Spacer	SR	718
JM	718110		JM718110	Outer	2TS-DM	694
JM	718110		JM718110	Outer	2TS-IM	670
JM	718110		JM718110	Outer	SR	718
JM	718110		JM718110	Outer	TS	294
M	718110	ES	M718110ES	Spacer	2TS-IM	670
M	718110	ES	M718110ES	Spacer	SR	718
JM	718149	A	JM718149A	Inner	TS	294
JM	718149		JM718149	Inner	2TS-DM	694
JM	718149		JM718149	Inner	2TS-IM	670
JM	718149		JM718149	Inner	SR	718
JM	718149		JM718149	Inner	TS	294
M	718149	XA	M718149XA	Spacer	2TS-IM	670
M	718149	XS	M718149XS	Spacer	SR	718
LM	718910		LM718910	Outer	TS	296
LM	718947		LM718947	Inner	TS	296
JM	719113		JM719113	Outer	2TS-DM	696
JM	719113		JM719113	Outer	SR	718
JM	719113		JM719113	Outer	TS	274
JM	719113		JM719113	Outer	TS	288
JM	719113		JM719113	Outer	TS	290
JM	719113		JM719113	Outer	TS	296
JM	719113		JM719113	Outer	TS	298
JM	719113		JM719113	Outer	TS	300

Prefix	Base	Suffix	Part Number Prefix + Base + Suffix	Part Type	Type	Page No.
M	719113	ES	M719113ES	Spacer	SR	718
JM	719149		JM719149	Inner	2TS-DM	696
JM	719149		JM719149	Inner	SR	718
JM	719149		JM719149	Inner	TS	298
M	719149	XS	M719149XS	Spacer	SR	718
EE	720125		EE720125	Inner	TS	370
EE	720128		EE720128	Inner	TS	370
HM	720210	ES	HM720210ES	Spacer	2TS-IM	672
HM	720210	ES	HM720210ES	Spacer	SR	718
JHM	720210		JHM720210	Outer	2TS-DM	696
JHM	720210		JHM720210	Outer	2TS-IM	672
JHM	720210		JHM720210	Outer	SR	718
JHM	720210		JHM720210	Outer	TS	304
JM	720210		JM720210	Outer	2TS-DM	696
JM	720210		JM720210	Outer	2TS-IM	670
JM	720210		JM720210	Outer	SR	718
JM	720210		JM720210	Outer	TS	304
M	720210	EB	M720210EB	Spacer	2TS-DM	696
M	720210	ES	M720210ES	Spacer	2TS-IM	670
M	720210	ES	M720210ES	Spacer	SR	718
	720236		720236	Outer	TS	370
JHM	720249		JHM720249	Inner	2TS-DM	696
JHM	720249		JHM720249	Inner	2TS-IM	672
JHM	720249		JHM720249	Inner	SR	718
JHM	720249		JHM720249	Inner	TS	304
JM	720249		JM720249	Inner	2TS-DM	696
JM	720249		JM720249	Inner	2TS-IM	670
JM	720249		JM720249	Inner	SR	718
JM	720249		JM720249	Inner	TS	304
M	720249	XA	M720249XA	Spacer	2TS-IM	670
M	720249	XB	M720249XB	Spacer	2TS-IM	672
LM	720610		LM720610	Outer	TS	306
LM	720648		LM720648	Inner	TS	306
EE	722110		EE722110	Inner	TDO	572
EE	722110		EE722110	Inner	TS	364
EE	722111	D	EE722111D	Inner	TDI	612
EE	722115		EE722115	Inner	TDO	572
EE	722115		EE722115	Inner	TS	366
	722185		722185	Outer	TDI	612
	722185		722185	Outer	TS	364
	722185		722185	Outer	TS	366
	722186	CD	722186CD	Outer	TDO	572
JLM	722912	-B	JLM722912-B	Outer	TSF	478
JLM	722912		JLM722912	Outer	TS	314
JLM	722948		JLM722948	Inner	TS	314
JLM	722948		JLM722948	Inner	TSF	478
EE	724119		EE724119	Inner	TDO	574
EE	724119		EE724119	Inner	TS	368
EE	724120		EE724120	Inner	TDO	576
EE	724120		EE724120	Inner	TS	368
EE	724121	D	EE724121D	Inner	TDI	614
	724195		724195	Outer	TDI	614
	724195		724195	Outer	TS	368
	724196	CD	724196CD	Outer	TDO	574
	724196	CD	724196CD	Outer	TDO	576
L	724310		L724310	Outer	TS	316

Prefix	Base	Suffix	Part Number Prefix + Base + Suffix	Part Type	Type	Page No.
JL	724314		JL724314	Outer	TS	316
JL	724348		JL724348	Inner	TS	316
L	724349		L724349	Inner	TS	316
L	725311		L725311	Outer	TS	318
JL	725316		JL725316	Outer	TS	318
JL	725346		JL725346	Inner	TS	318
L	725349		L725349	Inner	TS	318
NP	725758		NP725758	Outer	TS	376
EE	726182	TD	EE726182TD	Inner	TDIT	634
	726287		726287	Outer	TDIT	634
NP	726553		NP726553	Inner	TDI	626
L	730610		L730610	Outer	TS	330
JL	730612	-B	JL730612-B	Outer	TSF	482
JL	730612		JL730612	Outer	TS	330
JL	730646		JL730646	Inner	TS	330
JL	730646		JL730646	Inner	TSF	482
L	730649		L730649	Inner	TS	330
JM	734410		JM734410	Outer	2TS-DM	704
JM	734410		JM734410	Outer	2TS-IM	678
JM	734410		JM734410	Outer	2TS-IM	680
JM	734410		JM734410	Outer	SR	720
JM	734410		JM734410	Outer	TS	332
JM	734410		JM734410	Outer	TS	334
M	734410	EB	M734410EB	Spacer	2TS-DM	704
M	734410	ES	M734410ES	Spacer	2TS-IM	678
M	734410	ES	M734410ES	Spacer	2TS-IM	680
M	734410	ES	M734410ES	Spacer	SR	720
JM	734445		JM734445	Inner	TS	332
JM	734449	A	JM734449A	Inner	2TS-DM	704
JM	734449	A	JM734449A	Inner	2TS-IM	680
JM	734449		JM734449	Inner	2TS-IM	678
JM	734449		JM734449	Inner	SR	720
JM	734449		JM734449	Inner	TS	334
M	734449	XB	M734449XB	Spacer	2TS-IM	678
M	734449	XB	M734449XB	Spacer	2TS-IM	680
M	734449	XS	M734449XS	Spacer	SR	720
LL	735410		LL735410	Outer	TS	336
LL	735449		LL735449	Inner	TS	336
JM	736110		JM736110	Outer	2TS-DM	704
JM	736110		JM736110	Outer	2TS-IM	680
JM	736110		JM736110	Outer	SR	720
JM	736110		JM736110	Outer	TS	338
M	736110	ES	M736110ES	Spacer	2TS-IM	680
M	736110	ES	M736110ES	Spacer	SR	720
JM	736149	A	JM736149A	Inner	TS	338
JM	736149		JM736149	Inner	2TS-DM	704
JM	736149		JM736149	Inner	2TS-IM	680
JM	736149		JM736149	Inner	SR	720
JM	736149		JM736149	Inner	TS	338
M	736149	XC	M736149XC	Spacer	2TS-IM	680
M	736149	XS	M736149XS	Spacer	SR	720
EE	736160		EE736160	Inner	TDI	622
EE	736160		EE736160	Inner	TS	380
EE	736173	D	EE736173D	Inner	TDI	622
	736237		736237	Outer	TS	380
	736238		736238	Outer	TDI	622
	736238		736238	Outer	TS	380
	736239	D	736239D	Outer	TDI	622
EE	737173		EE737173	Inner	TDI	610
EE	737173		EE737173	Inner	TS	382
EE	737179	D	EE737179D	Inner	TDI	622
EE	737181	X	EE737181X	Inner	TS	384
EE	737181		EE737181	Inner	TDI	610
EE	737181		EE737181	Inner	TS	384
	737260		737260	Outer	TDI	622
	737260		737260	Outer	TS	382
	737260		737260	Outer	TS	384
	737261	CD	737261CD	Outer	TDI	610
	737261	D	737261D	Outer	TDI	610
	737262		737262	Outer	TS	384
EE	738101	D	EE738101D	Inner	TDI	610
	738172		738172	Outer	TDI	610
JM	738210		JM738210	Outer	2TS-DM	704
JM	738210		JM738210	Outer	2TS-IM	680
JM	738210		JM738210	Outer	SR	720
JM	738210		JM738210	Outer	TS	340
M	738210	ES	M738210ES	Spacer	2TS-IM	680
M	738210	ES	M738210ES	Spacer	SR	720
JM	738249		JM738249	Inner	2TS-DM	704
JM	738249		JM738249	Inner	2TS-IM	680
JM	738249		JM738249	Inner	SR	720
JM	738249		JM738249	Inner	TS	340
M	738249	XB	M738249XB	Spacer	2TS-IM	680
M	738249	XS	M738249XS	Spacer	SR	720
LM	739710	CD	LM739710CD	Outer	TDI	610
LM	739710	EA	LM739710EA	Spacer	2TS-IM	682
LM	739710		LM739710	Outer	2TS-IM	682
LM	739710		LM739710	Outer	TS	342
LM	739719		LM739719	Outer	TS	342
LM	739749	XE	LM739749XE	Spacer	2TS-IM	682
LM	739749		LM739749	Inner	2TS-IM	682
LM	739749		LM739749	Inner	TDI	610
LM	739749		LM739749	Inner	TS	342
NP	741064		NP741064	Inner	TDI	614
NP	741069		NP741069	Inner	TS	378
LM	742710	-B	LM742710-B	Outer	TSF	484
LM	742710	CD	LM742710CD	Outer	TDI	610
LM	742710		LM742710	Outer	2TS-IM	682
LM	742710		LM742710	Outer	TDI	610
LM	742710		LM742710	Outer	TDIT	630
LM	742710		LM742710	Outer	TS	346
LM	742710		LM742710	Outer	TS	348
LM	742714		LM742714	Outer	TDI	610
LM	742714		LM742714	Outer	TS	348
LM	742745		LM742745	Inner	TDI	610
LM	742745		LM742745	Inner	TDI	610
LM	742745		LM742745	Inner	TDI	610
LM	742745		LM742745	Inner	TS	346
LM	742746	TD	LM742746TD	Inner	TDIT	630
LM	742748		LM742748	Inner	TDI	610
LM	742748		LM742748	Inner	TDI	610
LM	742749	AA	LM742749AA	Inner	TS	348
LM	742749	D	LM742749D	Inner	TDI	610
LM	742749	XE	LM742749XE	Spacer	2TS-IM	682
LM	742749		LM742749	Inner	2TS-IM	682

TAPERED ROLLER BEARINGS

INDEX

Prefix	Base	Suffix	Part Number Prefix + Base + Suffix	Part Type	Type	Page No.
LM	742749		LM742749	Inner	TDO	560
LM	742749		LM742749	Inner	TS	346
LM	742749		LM742749	Inner	TS	348
LM	742749		LM742749	Inner	TSF	484
EE	743240		EE743240	Inner	TDO	592
EE	743240		EE743240	Inner	TS	390
HM	743310	CD	HM743310CD	Outer	TDO	558
HM	743310	CD	HM743310CD	Outer	TDO	560
HM	743310	EB	HM743310EB	Spacer	2TS-DM	706
HM	743310		HM743310	Outer	2TS-DM	706
HM	743310		HM743310	Outer	2TS-IM	682
	743320		743320	Outer	TS	390
	743321	CD	743321CD	Outer	TDO	592
HM	743337	XB	HM743337XB	Spacer	2TS-IM	682
HM	743337		HM743337	Inner	2TS-IM	682
HM	743337		HM743337	Inner	TDO	558
HM	743345		HM743345	Inner	2TS-DM	706
HM	743345		HM743345	Inner	TDO	560
HM	746610	CD	HM746610CD	Outer	TDO	564
HM	746610		HM746610	Outer	TS	350
HM	746646		HM746646	Inner	TDO	564
HM	746646		HM746646	Inner	TS	350
DX	748779		DX748779	Outer	TDO	580
EE	749260		EE749260	Inner	TDO	594
EE	749260		EE749260	Inner	TS	390
	749334		749334	Outer	TS	390
	749335	CD	749335CD	Outer	TDO	594
	749336		749336	Outer	TS	390
EE	750558		EE750558	Inner	2TS-IM	676
X1S-	750558		X1S-750558	Spacer	2TS-IM	676
EE	750576		EE750576	Inner	TS	328
Y5S-	751200		Y5S-751200	Spacer	2TS-IM	676
	751200		751200	Outer	2TS-IM	676
	751200		751200	Outer	TS	328
EE	752295		EE752295	Inner	TDO	594
EE	752295		EE752295	Inner	TS	392
EE	752300		EE752300	Inner	TDO	594
EE	752300		EE752300	Inner	TS	392
EE	752305		EE752305	Inner	TDO	594
EE	752305		EE752305	Inner	TS	392
	752380		752380	Outer	TS	392
	752381	CD	752381CD	Outer	TDO	594
	752381	D	752381D	Outer	TDO	594
EE	755280		EE755280	Inner	TDO	594
EE	755280		EE755280	Inner	TS	392
EE	755281	D	EE755281D	Inner	TDI	628
EE	755282		EE755282	Inner	TDO	594
EE	755285		EE755285	Inner	2TS-DM	710
EE	755285		EE755285	Inner	TDO	594
EE	755285		EE755285	Inner	TS	392
	755358	XD	755358XD	Outer	TDO	594
	755360		755360	Outer	2TS-DM	710
	755360		755360	Outer	TDI	628
	755360		755360	Outer	TS	392
	755361	CD	755361CD	Outer	TDO	594
	755367	CD	755367CD	Outer	TDO	594

Prefix	Base	Suffix	Part Number Prefix + Base + Suffix	Part Type	Type	Page No.
LM	757010	-B	LM757010-B	Outer	TSF	488
LM	757010	EC	LM757010EC	Spacer	2TS-IM	684
LM	757010	ES	LM757010ES	Spacer	2TS-DM	708
LM	757010		LM757010	Outer	2TS-DM	708
LM	757010		LM757010	Outer	2TS-IM	684
LM	757010		LM757010	Outer	TDIT	632
LM	757010		LM757010	Outer	TS	368
LM	757010		LM757010	Outer	TS	370
LM	757043	TD	LM757043TD	Inner	TDIT	632
LM	757049	A	LM757049A	Inner	TS	370
LM	757049	AA	LM757049AA	Inner	TS	368
LM	757049	XC	LM757049XC	Spacer	2TS-IM	684
LM	757049		LM757049	Inner	2TS-DM	708
LM	757049		LM757049	Inner	2TS-IM	684
LM	757049		LM757049	Inner	TS	368
LM	757049		LM757049	Inner	TSF	488
M	757410		M757410	Outer	TDI	614
M	757447	D	M757447D	Inner	TDI	614
LL	758715		LL758715	Outer	TS	370
LL	758744		LL758744	Inner	TS	370
DX	760136		DX760136	Inner	TDO	576
LM	761610		LM761610	Outer	TDI	616
LM	761649	D	LM761649D	Inner	TDI	616
EE	762320		EE762320	Inner	TDO	596
	762401	D	762401D	Outer	TDO	596
	762420	XD	762420XD	Outer	TDO	596
EE	763325		EE763325	Inner	TS	394
EE	763329		EE763329	Inner	TS	394
EE	763330		EE763330	Inner	TDO	596
EE	763330		EE763330	Inner	TS	394
LM	763410		LM763410	Outer	TDI	618
	763410	D	763410D	Outer	TDO	596
	763410		763410	Outer	TS	394
LM	763449	D	LM763449D	Inner	TDI	618
LM	765110		LM765110	Outer	TDI	618
LM	765149	D	LM765149D	Inner	TDI	618
LM	767710		LM767710	Outer	TDI	620
LM	767745	D	LM767745D	Inner	TDI	620
LM	767748	D	LM767748D	Inner	TDI	620
LM	769310	D	LM769310D	Outer	TDO	584
LM	769310		LM769310	Outer	TDIT	632
LM	769349	TD	LM769349TD	Inner	TDIT	632
LM	769349	X	LM769349X	Inner	TDO	584
L	770810		L770810	Outer	TDI	622
L	770849	D	L770849D	Inner	TDI	622
LM	770910	-B	LM770910-B	Outer	TSF	490
LM	770910		LM770910	Outer	TS	382
LM	770910		LM770910	Outer	TS	384
LM	770945		LM770945	Inner	TS	382
LM	770945		LM770945	Inner	TSF	490
LM	770949		LM770949	Inner	TS	384
LM	770949		LM770949	Inner	TSF	490
NP	771673		NP771673	Inner	TS	376
LL	771911	CD	LL771911CD	Outer	TDO	586
LL	771911	EA	LL771911EA	Spacer	2TS-DM	710
LL	771911	EB	LL771911EB	Spacer	2TS-IM	684

Prefix	Base	Suffix	Part Number Prefix + Base + Suffix	Part Type	Type	Page No.
LL	771911	EC	LL771911EC	Spacer	2TS-IM	684
LL	771911		LL771911	Outer	2TS-DM	710
LL	771911		LL771911	Outer	2TS-IM	684
LL	771911		LL771911	Outer	TS	384
LL	771948	XA	LL771948XA	Spacer	2TS-IM	684
LL	771948	XB	LL771948XB	Spacer	2TS-IM	684
LL	771948		LL771948	Inner	2TS-DM	710
LL	771948		LL771948	Inner	2TS-IM	684
LL	771948		LL771948	Inner	TDO	586
LL	771948		LL771948	Inner	TS	384
LM	772710	CD	LM772710CD	Outer	TDO	588
LM	772710		LM772710	Outer	2TS-IM	686
LM	772710		LM772710	Outer	TS	384
LM	772748	XR	LM772748XR	Spacer	2TS-IM	686
LM	772748	XS	LM772748XS	Spacer	2TS-IM	686
LM	772748		LM772748	Inner	2TS-IM	686
LM	772748		LM772748	Inner	TDO	588
LM	772748		LM772748	Inner	TS	384
EE	776420		EE776420	Inner	TS	394
EE	776430		EE776430	Inner	TS	396
	776520		776520	Outer	TS	394
	776520		776520	Outer	TS	396
L	778110		L778110	Outer	TS	388
LL	778110	EA	LL778110EA	Spacer	2TS-IM	686
LL	778110		LL778110	Outer	2TS-IM	686
LL	778110		LL778110	Outer	TS	388
L	778149		L778149	Inner	TS	388
LL	778149	XA	LL778149XA	Spacer	2TS-IM	686
LL	778149		LL778149	Inner	2TS-IM	686
LL	778149		LL778149	Inner	TS	388
LM	778510	D	LM778510D	Outer	TDO	592
LM	778549		LM778549	Inner	TDO	592
EE	780705		EE780705	Inner	TS	338
	781400		781400	Outer	TS	338
LL	788310	-B	LL788310-B	Outer	TSF	492
LL	788310		LL788310	Outer	TS	394
LL	788345		LL788345	Inner	TS	394
LL	788345		LL788345	Inner	TSF	492
LL	788349		LL788349	Inner	TS	394
LL	788349		LL788349	Inner	TSF	492
NP	789786		NP789786	Outer	TDO	580
LL	789810	D	LL789810D	Outer	TDO	596
LL	789849		LL789849	Inner	TDO	596
LL	789910	XD	LL789910XD	Outer	TDO	596
LL	789949		LL789949	Inner	TDO	596
EE	790114		EE790114	Inner	TDO	574
EE	790114		EE790114	Inner	TS	366
EE	790116		EE790116	Inner	TS	366
EE	790119	D	EE790119D	Inner	TDI	614
EE	790120		EE790120	Inner	TDO	576
EE	790120		EE790120	Inner	TS	368
	790221		790221	Outer	TDI	614
	790221		790221	Outer	TS	366
	790221		790221	Outer	TS	368
	790223	D	790223D	Outer	TDO	574
	790223	D	790223D	Outer	TDO	576

Prefix	Base	Suffix	Part Number Prefix + Base + Suffix	Part Type	Type	Page No.
NP	794398		NP794398	Inner	TS	388
HM	801310		HM801310	Outer	2TS-IM	660
HM	801310		HM801310	Outer	TS	152
HM	801310		HM801310	Outer	TS	162
HM	801311		HM801311	Outer	TS	152
HM	801346	X	HM801346X	Inner	TS	152
HM	801346		HM801346	Inner	TS	152
HM	801349	XA	HM801349XA	Spacer	2TS-IM	660
HM	801349		HM801349	Inner	2TS-IM	660
HM	801349		HM801349	Inner	TS	162
M	802011		M802011	Outer	2TS-IM	660
M	802011		M802011	Outer	TS	164
M	802047		M802047	Inner	TS	164
M	802048		M802048	Inner	2TS-IM	660
M	802048		M802048	Inner	TS	164
HM	803110	EB	HM803110EB	Spacer	2TS-DM	688
HM	803110		HM803110	Outer	2TS-DM	688
HM	803110		HM803110	Outer	TS	166
HM	803110		HM803110	Outer	TS	176
HM	803111		HM803111	Outer	TS	176
HM	803112		HM803112	Outer	TS	168
HM	803145		HM803145	Inner	TS	166
HM	803145		HM803145	Inner	TS	168
HM	803146		HM803146	Inner	TS	166
HM	803146		HM803146	Inner	TS	168
HM	803149		HM803149	Inner	2TS-DM	688
HM	803149		HM803149	Inner	TS	176
M	804010		M804010	Outer	TS	192
M	804048		M804048	Inner	TS	192
M	804049		M804049	Inner	TS	192
HM	804810	EE	HM804810EE	Spacer	2TS-DM	688
HM	804810		HM804810	Outer	2TS-DM	688
HM	804810		HM804810	Outer	TS	168
HM	804810		HM804810	Outer	TS	178
HM	804810		HM804810	Outer	TS	192
HM	804810		HM804810	Outer	TS	196
HM	804811	-B	HM804811-B	Outer	TSF	450
HM	804811		HM804811	Outer	TS	178
HM	804840		HM804840	Inner	TS	168
HM	804842		HM804842	Inner	TS	178
HM	804843		HM804843	Inner	TS	178
HM	804846		HM804846	Inner	TS	192
HM	804846		HM804846	Inner	TSF	450
HM	804848	A	HM804848A	Inner	TS	196
HM	804848		HM804848	Inner	2TS-DM	688
HM	804848		HM804848	Inner	TS	196
HM	804849		HM804849	Inner	TS	196
LM	806610		LM806610	Outer	2S	714
LM	806610		LM806610	Outer	TS	214
LM	806649		LM806649	Inner	2S	714
LM	806649		LM806649	Inner	TS	214
HM	807010	-B	HM807010-B	Outer	TSF	452
HM	807010	EC	HM807010EC	Spacer	2TS-IM	664
HM	807010	EE	HM807010EE	Spacer	2TS-DM	688
HM	807010		HM807010	Outer	2TS-DM	688
HM	807010		HM807010	Outer	2TS-IM	664

TAPERED ROLLER BEARINGS

INDEX

Prefix	Base	Suffix	Part Number Prefix + Base + Suffix	Part Type	Type	Page No.
HM	807010		HM807010	Outer	TS	168
HM	807010		HM807010	Outer	TS	182
HM	807010		HM807010	Outer	TS	196
HM	807010		HM807010	Outer	TS	208
HM	807010		HM807010	Outer	TS	216
HM	807010		HM807010	Outer	TS	220
HM	807011		HM807011	Outer	TS	208
HM	807011		HM807011	Outer	TS	216
HM	807012	ES	HM807012ES	Spacer	2TS-IM	662
HM	807012	ES	HM807012ES	Spacer	SR	716
JHM	807012		JHM807012	Outer	2TS-IM	662
JHM	807012		JHM807012	Outer	SR	716
JHM	807012		JHM807012	Outer	TS	182
JHM	807012		JHM807012	Outer	TS	200
JHM	807012		JHM807012	Outer	TS	208
HM	807035		HM807035	Inner	TS	168
HM	807040		HM807040	Inner	TS	182
HM	807044		HM807044	Inner	TS	196
HM	807045	XA	HM807045XA	Spacer	2TS-IM	662
HM	807045	XS	HM807045XS	Spacer	SR	716
JHM	807045		JHM807045	Inner	2TS-IM	662
JHM	807045		JHM807045	Inner	SR	716
JHM	807045		JHM807045	Inner	TS	200
HM	807046	XA	HM807046XA	Spacer	2TS-IM	664
HM	807046		HM807046	Inner	2TS-IM	664
HM	807046		HM807046	Inner	TS	208
HM	807046		HM807046	Inner	TSF	452
HM	807048		HM807048	Inner	TS	220
HM	807049	A	HM807049A	Inner	TS	216
HM	807049		HM807049	Inner	2TS-DM	688
HM	807049		HM807049	Inner	TS	216
L	812111		L812111	Outer	TS	248
L	812111		L812111	Outer	TS	250
L	812147		L812147	Inner	TS	248
L	812148		L812148	Inner	TS	250
JLM	813010		JLM813010	Outer	SR	716
JLM	813010		JLM813010	Outer	TS	262
LM	813010	ES	LM813010ES	Spacer	SR	716
JLM	813049		JLM813049	Inner	SR	716
JLM	813049		JLM813049	Inner	TS	262
LM	813049	XS	LM813049XS	Spacer	SR	716
HM	813810	EB	HM813810EB	Spacer	2TS-DM	692
HM	813810		HM813810	Outer	2TS-DM	692
HM	813810		HM813810	Outer	TS	210
HM	813810		HM813810	Outer	TS	222
HM	813810		HM813810	Outer	TS	232
HM	813810		HM813810	Outer	TS	236
HM	813810		HM813810	Outer	TS	238
HM	813810		HM813810	Outer	TS	244
HM	813810		HM813810	Outer	TS	254
HM	813810		HM813810	Outer	TS	260
HM	813810		HM813810	Outer	TS	264
HM	813811	EB	HM813811EB	Spacer	2TS-IM	666
HM	813811		HM813811	Outer	2TS-IM	666
HM	813811		HM813811	Outer	TS	222
HM	813811		HM813811	Outer	TS	236

Prefix	Base	Suffix	Part Number Prefix + Base + Suffix	Part Type	Type	Page No.
HM	813811		HM813811	Outer	TS	244
HM	813811		HM813811	Outer	TS	254
HM	813811		HM813811	Outer	TS	260
HM	813811		HM813811	Outer	TS	264
HM	813815	-B	HM813815-B	Outer	TSF	462
HM	813836		HM813836	Inner	TS	210
HM	813839		HM813839	Inner	TS	232
HM	813840		HM813840	Inner	TS	222
HM	813841	A	HM813841A	Inner	TS	236
HM	813841		HM813841	Inner	TS	236
HM	813842	A	HM813842A	Inner	TS	244
HM	813842		HM813842	Inner	TS	244
HM	813843		HM813843	Inner	TS	238
HM	813844		HM813844	Inner	TS	254
HM	813844		HM813844	Inner	TSF	462
HM	813846	XA	HM813846XA	Spacer	2TS-IM	666
HM	813846		HM813846	Inner	2TS-DM	692
HM	813846		HM813846	Inner	2TS-IM	666
HM	813846		HM813846	Inner	TS	260
HM	813849		HM813849	Inner	TS	264
NP	813945		NP813945	Inner	TS	390
HH	814510		HH814510	Outer	TS	230
HH	814510		HH814510	Outer	TS	236
HH	814510		HH814510	Outer	TS	256
HH	814540		HH814540	Inner	TS	230
HH	814542		HH814542	Inner	TS	236
HH	814547		HH814547	Inner	TS	256
L	814710	D	L814710D	Outer	TDO	530
L	814710		L814710	Outer	TS	270
L	814749		L814749	Inner	TDO	530
L	814749		L814749	Inner	TS	270
LM	814810	-B	LM814810-B	Outer	TSF	466
LM	814810	-B	LM814810-B	Outer	TSF	468
LM	814810	EA	LM814810EA	Spacer	2TS-DM	694
LM	814810		LM814810	Outer	2TS-DM	694
LM	814810		LM814810	Outer	TS	266
LM	814810		LM814810	Outer	TS	276
LM	814814		LM814814	Outer	TS	276
LM	814845		LM814845	Inner	TS	266
LM	814845		LM814845	Inner	TSF	466
LM	814849		LM814849	Inner	2TS-DM	694
LM	814849		LM814849	Inner	TS	276
LM	814849		LM814849	Inner	TSF	468
H	816210		H816210	Outer	TS	276
H	816249		H816249	Inner	TS	276
JL	819310		JL819310	Outer	TS	298
JL	819349		JL819349	Inner	TS	298
JLM	820012		JLM820012	Outer	TS	304
JLM	820048		JLM820048	Inner	TS	304
EE	820085		EE820085	Inner	TDO	562
EE	820085		EE820085	Inner	TSF	484
	820160	-B	820160-B	Outer	TSF	484
	820161	CD	820161CD	Outer	TDO	562
EE	821096	D	EE821096D	Inner	TDI	608
	821165		821165	Outer	TDI	608
HM	821511	D	HM821511D	Outer	TDO	540

Prefix	Base	Suffix	Part Number Prefix + Base + Suffix	Part Type	Type	Page No.
HM	821547		HM821547	Inner	TDO	540
JM	822010		JM822010	Outer	2TS-DM	698
JM	822010		JM822010	Outer	2TS-IM	672
JM	822010		JM822010	Outer	SR	718
JM	822010		JM822010	Outer	TS	312
M	822010	EA	M822010EA	Spacer	2TS-DM	698
M	822010	ES	M822010ES	Spacer	2TS-IM	672
M	822010	ES	M822010ES	Spacer	SR	718
JM	822049		JM822049	Inner	2TS-DM	698
JM	822049		JM822049	Inner	2TS-IM	672
JM	822049		JM822049	Inner	SR	718
JM	822049		JM822049	Inner	TS	312
M	822049	XA	M822049XA	Spacer	2TS-IM	672
EE	822100		EE822100	Inner	TDO	568
EE	822100		EE822100	Inner	TS	358
EE	822101	D	EE822101D	Inner	TDI	610
	822175		822175	Outer	TDI	610
	822175		822175	Outer	TS	358
	822176	D	822176D	Outer	TDO	568
EE	823103	D	EE823103D	Inner	TDI	610
	823175		823175	Outer	TDI	610
NP	830348		NP830348	Inner	TDO	592
EE	833161	XD	EE833161XD	Inner	TDI	620
	833232		833232	Outer	TDI	620
NP	837820		NP837820	Inner	2TS-DM	710
HH	840210	EA	HH840210EA	Spacer	2TS-DM	706
HH	840210	EB	HH840210EB	Spacer	2TS-IM	680
HH	840210		HH840210	Outer	2TS-DM	706
HH	840210		HH840210	Outer	2TS-IM	680
HH	840210		HH840210	Outer	TS	340
HH	840249	XA	HH840249XA	Spacer	2TS-IM	680
HH	840249		HH840249	Inner	2TS-DM	706
HH	840249		HH840249	Inner	2TS-IM	680
HH	840249		HH840249	Inner	TS	340
HM	840410	EA	HM840410EA	Spacer	2TS-IM	682
JHM	840410		JHM840410	Outer	2TS-IM	682
JHM	840410		JHM840410	Outer	TS	342
HM	840449	XA	HM840449XA	Spacer	2TS-IM	682
JHM	840449		JHM840449	Inner	2TS-IM	682
JHM	840449		JHM840449	Inner	TS	342
EE	843220		EE843220	Inner	TDO	590
EE	843220		EE843220	Inner	TS	388
EE	843221	D	EE843221D	Inner	TDI	626
	843290		843290	Outer	TDI	626
	843290		843290	Outer	TS	388
	843291	CD	843291CD	Outer	TDO	590
	843292	D	843292D	Outer	TDO	590
LM	844010		LM844010	Outer	TS	348
LM	844049		LM844049	Inner	TS	348
JL	848815	-B	JL848815-B	Outer	TSF	486
L	848849		L848849	Inner	TSF	486
NP	852610		NP852610	Inner	2TS-DM	710
H	852810	EA	H852810EA	Spacer	2TS-IM	684
H	852810	EB	H852810EB	Spacer	2TS-DM	708
H	852810		H852810	Outer	2TS-DM	708
H	852810		H852810	Outer	2TS-IM	684

Prefix	Base	Suffix	Part Number Prefix + Base + Suffix	Part Type	Type	Page No.
H	852810		H852810	Outer	TS	362
H	852849	XA	H852849XA	Spacer	2TS-IM	684
H	852849		H852849	Inner	2TS-DM	708
H	852849		H852849	Inner	2TS-IM	684
H	852849		H852849	Inner	TS	362
L	853010	W	L853010W	Outer	TS	364
L	853010		L853010	Outer	TS	364
L	853011	-B	L853011-B	Outer	TSF	486
L	853011	-B	L853011-B	Outer	TSF	488
L	853042		L853042	Inner	TSF	486
L	853048		L853048	Inner	TS	364
L	853049		L853049	Inner	TS	364
L	853049		L853049	Inner	TSF	488
HM	855419	D	HM855419D	Outer	TDO	572
HM	855449		HM855449	Inner	TDO	572
HM	858511		HM858511	Outer	TDI	616
HM	858548	D	HM858548D	Inner	TDI	616
H	859010		H859010	Outer	TS	370
H	859049		H859049	Inner	TS	370
L	860010	CD	L860010CD	Outer	TDO	576
L	860010		L860010	Outer	TS	372
L	860048		L860048	Inner	TDO	576
L	860048		L860048	Inner	TS	372
L	860049	A	L860049A	Inner	TS	372
L	860049	AA	L860049AA	Inner	TS	372
L	860049		L860049	Inner	TDO	576
L	860049		L860049	Inner	TS	372
L	865512	-B	L865512-B	Outer	TSF	490
L	865512	EA	L865512EA	Spacer	2TS-DM	708
L	865512		L865512	Outer	2TS-DM	708
L	865512		L865512	Outer	2TS-IM	684
L	865512		L865512	Outer	TS	376
L	865547	XA	L865547XA	Spacer	2TS-IM	684
L	865547		L865547	Inner	2TS-DM	708
L	865547		L865547	Inner	2TS-IM	684
L	865547		L865547	Inner	TS	376
L	865547		L865547	Inner	TSF	490
L	865548		L865548	Inner	TS	376
NP	868174		NP868174	Inner	TDIT	632
LM	869410	CD	LM869410CD	Outer	TDO	584
LM	869410	EB	LM869410EB	Spacer	2TS-DM	710
LM	869410		LM869410	Outer	2TS-DM	710
LM	869410		LM869410	Outer	TS	382
LM	869448		LM869448	Inner	2TS-DM	710
LM	869448		LM869448	Inner	TDO	584
LM	869448		LM869448	Inner	TS	382
LL	876410		LL876410	Outer	TDI	624
LL	876449	D	LL876449D	Inner	TDI	624
NP	876612		NP876612	Outer	TS	386
L	879910		L879910	Outer	TS	388
L	879946		L879946	Inner	TS	388
L	879947		L879947	Inner	TS	388
LM	881214		LM881214	Outer	TDI	626
LM	881245	D	LM881245D	Inner	TDI	626
L	882410	CD	L882410CD	Outer	TDO	594
L	882449		L882449	Inner	TDO	594

TAPERED ROLLER BEARINGS

INDEX

Prefix	Base	Suffix	Part Number Prefix + Base + Suffix	Part Type	Type	Page No.
LL	889010	-B	LL889010-B	Outer	TSF	492
LL	889010	D	LL889010D	Outer	TDO	596
LL	889010		LL889010	Outer	TS	396
LL	889049		LL889049	Inner	TDO	596
LL	889049		LL889049	Inner	TS	396
LL	889049		LL889049	Inner	TSF	492
HM	903210	ES	HM903210ES	Spacer	2TS-DM	688
HM	903210		HM903210	Outer	2TS-DM	688
HM	903210		HM903210	Outer	2TS-IM	662
HM	903210		HM903210	Outer	TS	168
HM	903210		HM903210	Outer	TS	178
HM	903210		HM903210	Outer	TS	180
HM	903210		HM903210	Outer	TS	184
HM	903216		HM903216	Outer	TS	168
HM	903216		HM903216	Outer	TS	180
HM	903244		HM903244	Inner	TS	168
HM	903245		HM903245	Inner	TS	168
HM	903247		HM903247	Inner	TS	180
HM	903248		HM903248	Inner	TS	184
HM	903249	A	HM903249A	Inner	TS	180
HM	903249	XC	HM903249XC	Spacer	2TS-IM	662
HM	903249		HM903249	Inner	2TS-DM	688
HM	903249		HM903249	Inner	2TS-IM	662
HM	903249		HM903249	Inner	TS	178
HM	903249		HM903249	Inner	TS	180
M	903310		M903310	Outer	TS	168
M	903345		M903345	Inner	TS	168
HM	905810		HM905810	Outer	2TS-IM	662
HM	905843	XA	HM905843XA	Spacer	2TS-IM	662
HM	905843		HM905843	Inner	2TS-IM	662
HM	907614		HM907614	Outer	TS	182
HM	907614		HM907614	Outer	TS	194
HM	907614		HM907614	Outer	TS	208
HM	907616		HM907616	Outer	TS	182
HM	907616		HM907616	Outer	TS	194
HM	907635		HM907635	Inner	TS	182
HM	907639		HM907639	Inner	TS	194
HM	907643		HM907643	Inner	TS	208
HM	911210	-B	HM911210-B	Outer	TSF	458
HM	911210	-B	HM911210-B	Outer	TSF	460
HM	911210	EC	HM911210EC	Spacer	2TS-DM	690
HM	911210		HM911210	Outer	2TS-DM	690
HM	911210		HM911210	Outer	TS	218
HM	911210		HM911210	Outer	TS	232
HM	911210		HM911210	Outer	TS	236
HM	911210		HM911210	Outer	TS	238
HM	911216		HM911216	Outer	TS	218
HM	911216		HM911216	Outer	TS	232
HM	911242		HM911242	Inner	TS	218
HM	911243		HM911243	Inner	TS	218
HM	911244		HM911244	Inner	TS	232
HM	911244		HM911244	Inner	TSF	458
HM	911245		HM911245	Inner	2TS-DM	690
HM	911245		HM911245	Inner	TS	236
HM	911245		HM911245	Inner	TSF	460
HM	911249		HM911249	Inner	TS	238

Prefix	Base	Suffix	Part Number Prefix + Base + Suffix	Part Type	Type	Page No.
HM	911249		HM911249	Inner	TSF	460
NP	911398		NP911398	Inner	TDO	574
EE	911600		EE911600	Inner	TDO	582
EE	911600		EE911600	Inner	TS	380
EE	911603	D	EE911603D	Inner	TDI	620
EE	911618		EE911618	Inner	TDO	584
EE	911618		EE911618	Inner	TS	380
	912400		912400	Outer	TDI	620
	912400		912400	Outer	TS	380
	912401	D	912401D	Outer	TDO	582
	912401	D	912401D	Outer	TDO	584
H	913810	EA	H913810EA	Spacer	2TS-DM	690
H	913810	EA	H913810EA	Spacer	2TS-DM	692
H	913810	EE	H913810EE	Spacer	2TS-IM	666
H	913810	ES	H913810ES	Spacer	2TS-IM	666
H	913810		H913810	Outer	2TS-DM	690
H	913810		H913810	Outer	2TS-DM	692
H	913810		H913810	Outer	2TS-IM	666
H	913810		H913810	Outer	TS	232
H	913810		H913810	Outer	TS	238
H	913810		H913810	Outer	TS	260
H	913840		H913840	Inner	TS	232
H	913842		H913842	Inner	2TS-DM	690
H	913842		H913842	Inner	TS	238
H	913843		H913843	Inner	TS	238
H	913849	XA	H913849XA	Spacer	2TS-IM	666
H	913849	XC	H913849XC	Spacer	2TS-IM	666
H	913849	XE	H913849XE	Spacer	2TS-IM	666
H	913849		H913849	Inner	2TS-DM	692
H	913849		H913849	Inner	2TS-IM	666
H	913849		H913849	Inner	TS	260
HH	914412	EA	HH914412EA	Spacer	2TS-DM	690
HH	914412	EB	HH914412EB	Spacer	2TS-IM	666
HH	914412		HH914412	Outer	2TS-DM	690
HH	914412		HH914412	Outer	2TS-IM	666
HH	914412		HH914412	Outer	TS	246
HH	914412		HH914412	Outer	TS	256
HH	914447		HH914447	Inner	TS	246
HH	914449	XA	HH914449XA	Spacer	2TS-IM	666
HH	914449		HH914449	Inner	2TS-DM	690
HH	914449		HH914449	Inner	2TS-IM	666
HH	914449		HH914449	Inner	TS	256
HM	914510		HM914510	Outer	TS	260
HM	914545		HM914545	Inner	TS	260
H	914811		H914811	Outer	TS	258
H	914841		H914841	Inner	TS	258
NP	915736		NP915736	Inner	TDO	590
H	916610		H916610	Outer	TS	262
H	916642		H916642	Inner	TS	262
H	917810	EA	H917810EA	Spacer	2TS-IM	668
H	917810		H917810	Outer	2TS-IM	668
H	917810		H917810	Outer	TS	276
H	917810		H917810	Outer	TS	284
H	917840	XA	H917840XA	Spacer	2TS-IM	668
H	917840		H917840	Inner	2TS-IM	668
H	917840		H917840	Inner	TS	276

Prefix	Base	Suffix	Part Number Prefix + Base + Suffix	Part Type	Type	Page No.
H	917849		H917849	Inner	TS	284
M	919010	D	M919010D	Outer	TDO	536
M	919048		M919048	Inner	TDO	536
NP	920752		NP920752	Outer	TDO	590
EE	921124		EE921124	Inner	TDO	572
EE	921124		EE921124	Inner	TS	366
EE	921150	D	EE921150D	Inner	TDI	612
HM	921310	D	HM921310D	Outer	TDO	536
HM	921343		HM921343	Inner	TDO	536
LM	921810		LM921810	Outer	TS	306
LM	921845		LM921845	Inner	TS	306
	921850		921850	Outer	TDI	612
	921850		921850	Outer	TS	366
	921851	D	921851D	Outer	TDO	572
	921875		921875	Outer	TDI	612
	921875		921875	Outer	TS	366
	921876	D	921876D	Outer	TDO	572
EE	923095		EE923095	Inner	TDO	566
EE	923095		EE923095	Inner	TS	356
	923175		923175	Outer	TS	356
	923176	D	923176D	Outer	TDO	566
HH	923610	EA	HH923610EA	Spacer	2TS-DM	696
HH	923610	ES	HH923610ES	Spacer	2TS-IM	672
HH	923610		HH923610	Outer	2TS-DM	696
HH	923610		HH923610	Outer	2TS-IM	672
HH	923611		HH923611	Outer	TS	308
HH	923649	XA	HH923649XA	Spacer	2TS-IM	672
HH	923649	XC	HH923649XC	Spacer	2TS-IM	672
HH	923649		HH923649	Inner	2TS-DM	696
HH	923649		HH923649	Inner	2TS-IM	672
HH	923649		HH923649	Inner	TS	308
H	924010	D	H924010D	Outer	TDO	542
H	924010	EA	H924010EA	Spacer	2TS-DM	698
H	924010		H924010	Outer	2TS-DM	698
H	924010		H924010	Outer	TS	308
H	924010		H924010	Outer	TS	312
H	924033		H924033	Inner	TDO	542
H	924033		H924033	Inner	TS	308
H	924043		H924043	Inner	TS	312
H	924045		H924045	Inner	2TS-DM	698
H	924045		H924045	Inner	TS	312
EE	925179	D	EE925179D	Inner	TDI	622
	925295		925295	Outer	TDI	622
HH	926710	EA	HH926710EA	Spacer	2TS-IM	674
HH	926710	EB	HH926710EB	Spacer	2TS-DM	698
HH	926710	EX	HH926710EX	Spacer	2TS-IM	674
HH	926710		HH926710	Outer	2TS-DM	698
HH	926710		HH926710	Outer	2TS-IM	674
HH	926710		HH926710	Outer	TS	314
HH	926710		HH926710	Outer	TS	318
HM	926710	CD	HM926710CD	Outer	TDO	548
HM	926710	CD	HM926710CD	Outer	TNA	644
HM	926710	EB	HM926710EB	Spacer	2TS-IM	674
HM	926710	EB	HM926710EB	Spacer	2TS-IM	676
HM	926710	EE	HM926710EE	Spacer	2TS-DM	698
HM	926710	EE	HM926710EE	Spacer	2TS-DM	700

Prefix	Base	Suffix	Part Number Prefix + Base + Suffix	Part Type	Type	Page No.
HM	926710	ER	HM926710ER	Spacer	2TS-IM	674
HM	926710		HM926710	Outer	2TS-DM	698
HM	926710		HM926710	Outer	2TS-DM	700
HM	926710		HM926710	Outer	2TS-IM	674
HM	926710		HM926710	Outer	2TS-IM	676
HM	926710		HM926710	Outer	TS	314
HM	926710		HM926710	Outer	TS	318
HM	926710		HM926710	Outer	TS	320
HH	926716	EB	HH926716EB	Spacer	2TS-IM	674
HH	926716	EC	HH926716EC	Spacer	2TS-DM	698
HH	926716		HH926716	Outer	2TS-DM	698
HH	926716		HH926716	Outer	2TS-IM	674
HH	926716		HH926716	Outer	TS	314
HM	926740	NA	HM926740NA	Inner	TNA	644
HM	926740	XE	HM926740XE	Spacer	2TS-IM	674
HM	926740		HM926740	Inner	2TS-DM	698
HM	926740		HM926740	Inner	2TS-IM	674
HM	926740		HM926740	Inner	TS	314
HH	926744	XB	HH926744XB	Spacer	2TS-IM	674
HH	926744	XE	HH926744XE	Spacer	2TS-IM	674
HH	926744		HH926744	Inner	2TS-DM	698
HH	926744		HH926744	Inner	2TS-IM	674
HH	926744		HH926744	Inner	TS	314
HM	926745	XA	HM926745XA	Spacer	2TS-IM	674
HM	926745		HM926745	Inner	2TS-DM	700
HM	926745		HM926745	Inner	2TS-IM	674
HM	926745		HM926745	Inner	TS	318
HM	926747	XE	HM926747XE	Spacer	2TS-IM	676
HM	926747		HM926747	Inner	2TS-DM	700
HM	926747		HM926747	Inner	2TS-IM	676
HM	926747		HM926747	Inner	TDO	548
HM	926747		HM926747	Inner	TS	320
HH	926749	XA	HH926749XA	Spacer	2TS-IM	674
HH	926749		HH926749	Inner	2TS-DM	698
HH	926749		HH926749	Inner	2TS-IM	674
HH	926749		HH926749	Inner	TS	318
HM	926749	XE	HM926749XE	Spacer	2TS-IM	676
HM	926749		HM926749	Inner	2TS-DM	700
HM	926749		HM926749	Inner	2TS-IM	676
HM	926749		HM926749	Inner	TS	320
EE	929225		EE929225	Inner	TDO	590
	929341	D	929341D	Outer	TDO	590
NP	930308		NP930308	Outer	TNASW	652
EE	931170	D	EE931170D	Inner	TDI	622
	931250		931250	Outer	TDI	622
HH	932110	EA	HH932110EA	Spacer	2TS-IM	676
HH	932110	EB	HH932110EB	Spacer	2TS-IM	678
HH	932110	EC	HH932110EC	Spacer	2TS-DM	700
HH	932110	EC	HH932110EC	Spacer	2TS-DM	702
HH	932110		HH932110	Outer	2TS-DM	700
HH	932110		HH932110	Outer	2TS-DM	702
HH	932110		HH932110	Outer	2TS-IM	676
HH	932110		HH932110	Outer	2TS-IM	678
HH	932110		HH932110	Outer	TS	320
HH	932110		HH932110	Outer	TS	328
HH	932115	EC	HH932115EC	Spacer	2TS-IM	678

TAPERED ROLLER BEARINGS

INDEX

Prefix	Base	Suffix	Part Number Prefix + Base + Suffix	Part Type	Type	Page No.
HH	932115		HH932115	Outer	2TS-IM	678
HH	932115		HH932115	Outer	TS	320
HH	932115		HH932115	Outer	TS	328
HH	932132	XA	HH932132XA	Spacer	2TS-IM	676
HH	932132		HH932132	Inner	2TS-DM	700
HH	932132		HH932132	Inner	2TS-IM	676
HH	932132		HH932132	Inner	TS	320
HH	932145	XA	HH932145XA	Spacer	2TS-IM	678
HH	932145	XE	HH932145XE	Spacer	2TS-IM	678
HH	932145		HH932145	Inner	2TS-DM	702
HH	932145		HH932145	Inner	2TS-IM	678
HH	932145		HH932145	Inner	TS	328
NP	934748		NP934748	Inner	TDO	590
H	936310	EA	H936310EA	Spacer	2TS-DM	702
H	936310	EC	H936310EC	Spacer	2TS-IM	678
H	936310	EE	H936310EE	Spacer	2TS-IM	678
H	936310	EG	H936310EG	Spacer	2TS-IM	678
H	936310		H936310	Outer	2TS-DM	702
H	936310		H936310	Outer	2TS-IM	678
H	936310		H936310	Outer	TS	332
H	936310		H936310	Outer	TS	334
H	936313		H936313	Outer	TS	332
H	936316	EG	H936316EG	Spacer	2TS-IM	678
H	936316		H936316	Outer	2TS-IM	678
H	936316		H936316	Outer	TS	332
H	936316		H936316	Outer	TS	334
H	936340	XA	H936340XA	Spacer	2TS-IM	678
H	936340	XE	H936340XE	Spacer	2TS-IM	678
H	936340		H936340	Inner	2TS-DM	702
H	936340		H936340	Inner	2TS-IM	678
H	936340		H936340	Inner	TS	332
H	936349	XB	H936349XB	Spacer	2TS-IM	678
H	936349	XC	H936349XC	Spacer	2TS-IM	678
H	936349	XS	H936349XS	Spacer	2TS-IM	678
H	936349		H936349	Inner	2TS-DM	702
H	936349		H936349	Inner	2TS-IM	678
H	936349		H936349	Inner	TS	334
EE	941002		EE941002	Inner	TDO	568
EE	941002		EE941002	Inner	TS	360
EE	941205	X	EE941205X	Inner	TS	368
EE	941205		EE941205	Inner	TDO	574
EE	941205		EE941205	Inner	TS	368
	941950		941950	Outer	TS	360
	941950		941950	Outer	TS	368
	941951	XD	941951XD	Outer	TDO	568
	941951	XD	941951XD	Outer	TDO	574
	941953	D	941953D	Outer	TDO	568
	941953	D	941953D	Outer	TDO	574
DX	948645		DX948645	Thrust	TTHDFL	729
HH	949510	D	HH949510D	Outer	TDO	564
HH	949510		HH949510	Outer	2TS-DM	708
HH	949510		HH949510	Outer	TS	350
HH	949549		HH949549	Inner	2TS-DM	708
HH	949549		HH949549	Inner	TDO	564
HH	949549		HH949549	Inner	TS	350
HH	953710	D	HH953710D	Outer	TDO	568

Prefix	Base	Suffix	Part Number Prefix + Base + Suffix	Part Type	Type	Page No.
HH	953710	X	HH953710X	Outer	TS	360
HH	953710		HH953710	Outer	2TS-DM	708
HH	953710		HH953710	Outer	TS	360
HH	953749		HH953749	Inner	2TS-DM	708
HH	953749		HH953749	Inner	TDO	568
HH	953749		HH953749	Inner	TS	360
LL	957010		LL957010	Outer	TS	370
LL	957049		LL957049	Inner	TS	370
NP	957630		NP957630	Inner	TS	394
M	959410	EB	M959410EB	Spacer	2TS-DM	708
M	959410		M959410	Outer	2TS-DM	708
M	959410		M959410	Outer	TS	368
M	959442		M959442	Inner	2TS-DM	708
M	959442		M959442	Inner	TS	368
HM	959618		HM959618	Outer	TDI	616
HM	959649	D	HM959649D	Inner	TDI	616
NP	961009		NP961009	Outer	TDO	596
LM	961510		LM961510	Outer	TS	372
LM	961511	CD	LM961511CD	Outer	TDO	578
LM	961511	D	LM961511D	Outer	TDO	578
LM	961511		LM961511	Outer	TDI	616
LM	961511		LM961511	Outer	TS	372
LM	961548	D	LM961548D	Inner	TDI	616
LM	961548		LM961548	Inner	TDO	578
LM	961548		LM961548	Inner	TS	372
H	961610	CD	H961610CD	Outer	TDO	576
H	961610	EB	H961610EB	Spacer	2TS-IM	684
H	961610		H961610	Outer	2TS-IM	684
H	961610		H961610	Outer	TS	370
H	961649	XA	H961649XA	Spacer	2TS-IM	684
H	961649		H961649	Inner	2TS-IM	684
H	961649		H961649	Inner	TDO	576
H	961649		H961649	Inner	TS	370
H	969210	D	H969210D	Outer	TDO	584
H	969210		H969210	Outer	TS	380
H	969249		H969249	Inner	TDO	584
H	969249		H969249	Inner	TS	380
EE	971298		EE971298	Inner	TDO	576
EE	971298		EE971298	Inner	TS	370
EE	971354		EE971354	Inner	TDO	578
EE	971354		EE971354	Inner	TS	372
EE	971355	D	EE971355D	Inner	TDI	616
	972100		972100	Outer	TDI	616
	972100		972100	Outer	TS	370
	972100		972100	Outer	TS	372
	972102	CD	972102CD	Outer	TDO	578
	972103	D	972103D	Outer	TDO	576
	972103	D	972103D	Outer	TDO	578
	972151	D	972151D	Outer	TDO	576
	972151	D	972151D	Outer	TDO	578
DX	979640		DX979640	Outer	TDO	560
NP	980281		NP980281	Outer	TS	394
EE	982003		EE982003	Inner	TDO	588
EE	982003		EE982003	Inner	TS	386
EE	982028		EE982028	Inner	TDO	588
EE	982028		EE982028	Inner	TS	386

Prefix	Base	Suffix	Part Number Prefix + Base + Suffix	Part Type	Type	Page No.
EE	982051		EE982051	Inner	TDO	588
EE	982051		EE982051	Inner	TS	386
	982900		982900	Outer	TS	386
	982901	CD	982901CD	Outer	TDO	588
NP	985601		NP985601	Inner	TDO	566
LM	986910	D	LM986910D	Outer	TDO	596
LM	986949		LM986949	Inner	TDO	596
EE	991201		EE991201	Inner	TS	368
EE	991251		EE991251	Inner	TS	370
	992550		992550	Outer	TS	368
	992550		992550	Outer	TS	370
NP	993155		NP993155	Outer	TDO	574
NP	995051		NP995051	Inner	TDO	562

AUXILIARY

Base	Suffix	Part Number Prefix + Base + Suffix	Part Type	Type	Page No.
K20605		K20605	Auxiliary	Cup Shims	744
K20607		K20607	Auxiliary	Cup Shims	744
K20620		K20620	Auxiliary	Cup Shims	744
K20705		K20705	Auxiliary	Cup Shims	744
K20707		K20707	Auxiliary	Cup Shims	744
K20720		K20720	Auxiliary	Cup Shims	744
K20805		K20805	Auxiliary	Cup Shims	744
K20807		K20807	Auxiliary	Cup Shims	744
K20820		K20820	Auxiliary	Cup Shims	744
K20905		K20905	Auxiliary	Cup Shims	744
K20907		K20907	Auxiliary	Cup Shims	744
K20920		K20920	Auxiliary	Cup Shims	744
K21005		K21005	Auxiliary	Cup Shims	744
K21007		K21007	Auxiliary	Cup Shims	744
K21020		K21020	Auxiliary	Cup Shims	744
K21105		K21105	Auxiliary	Cup Shims	744
K21107		K21107	Auxiliary	Cup Shims	744
K21120		K21120	Auxiliary	Cup Shims	744
K21205		K21205	Auxiliary	Cup Shims	744
K21207		K21207	Auxiliary	Cup Shims	744
K21220		K21220	Auxiliary	Cup Shims	744
K21405		K21405	Auxiliary	Cup Shims	744
K21407		K21407	Auxiliary	Cup Shims	744
K21420		K21420	Auxiliary	Cup Shims	744
K21505		K21505	Auxiliary	Cup Shims	744
K21507		K21507	Auxiliary	Cup Shims	744
K21520		K21520	Auxiliary	Cup Shims	744
K21605		K21605	Auxiliary	Cup Shims	744
K21607		K21607	Auxiliary	Cup Shims	744
K21620		K21620	Auxiliary	Cup Shims	744
K21705		K21705	Auxiliary	Cup Shims	744
K21707		K21707	Auxiliary	Cup Shims	744
K21720		K21720	Auxiliary	Cup Shims	744
K21805		K21805	Auxiliary	Cup Shims	744
K21807		K21807	Auxiliary	Cup Shims	744
K21820		K21820	Auxiliary	Cup Shims	744
K21905		K21905	Auxiliary	Cup Shims	744
K21907		K21907	Auxiliary	Cup Shims	744
K21920		K21920	Auxiliary	Cup Shims	744
K22005		K22005	Auxiliary	Cup Shims	744
K22007		K22007	Auxiliary	Cup Shims	744
K22020		K22020	Auxiliary	Cup Shims	744
K22205		K22205	Auxiliary	Cup Shims	744
K22207		K22207	Auxiliary	Cup Shims	744
K22220		K22220	Auxiliary	Cup Shims	744
K22405		K22405	Auxiliary	Cup Shims	744
K22407		K22407	Auxiliary	Cup Shims	744
K22420		K22420	Auxiliary	Cup Shims	744
K22505		K22505	Auxiliary	Cup Shims	744
K22507		K22507	Auxiliary	Cup Shims	744
K22520		K22520	Auxiliary	Cup Shims	744
K22605		K22605	Auxiliary	Cup Shims	744
K22607		K22607	Auxiliary	Cup Shims	744
K22620		K22620	Auxiliary	Cup Shims	744

TAPERED ROLLER BEARINGS

INDEX

Base	Suffix	Part Number Prefix + Base + Suffix	Part Type	Type	Page No.
K22705		K22705	Auxiliary	Cup Shims	744
K22707		K22707	Auxiliary	Cup Shims	744
K22720		K22720	Auxiliary	Cup Shims	744
K22905		K22905	Auxiliary	Cup Shims	744
K22907		K22907	Auxiliary	Cup Shims	744
K22920		K22920	Auxiliary	Cup Shims	744
K23005		K23005	Auxiliary	Cup Shims	744
K23007		K23007	Auxiliary	Cup Shims	744
K23020		K23020	Auxiliary	Cup Shims	744
K23205		K23205	Auxiliary	Cup Shims	744
K23207		K23207	Auxiliary	Cup Shims	744
K23220		K23220	Auxiliary	Cup Shims	744
K23405		K23405	Auxiliary	Cup Shims	744
K23407		K23407	Auxiliary	Cup Shims	744
K23420		K23420	Auxiliary	Cup Shims	744
K23605		K23605	Auxiliary	Cup Shims	744
K23607		K23607	Auxiliary	Cup Shims	744
K23620		K23620	Auxiliary	Cup Shims	744
K23805		K23805	Auxiliary	Cup Shims	744
K23807		K23807	Auxiliary	Cup Shims	744
K23820		K23820	Auxiliary	Cup Shims	744
K24005		K24005	Auxiliary	Cup Shims	744
K24007		K24007	Auxiliary	Cup Shims	744
K24020		K24020	Auxiliary	Cup Shims	744
K24105		K24105	Auxiliary	Cup Shims	744
K24107		K24107	Auxiliary	Cup Shims	744
K24120		K24120	Auxiliary	Cup Shims	744
K24205		K24205	Auxiliary	Cup Shims	744
K24207		K24207	Auxiliary	Cup Shims	744
K24220		K24220	Auxiliary	Cup Shims	744
K24405		K24405	Auxiliary	Cup Shims	744
K24407		K24407	Auxiliary	Cup Shims	744
K24420		K24420	Auxiliary	Cup Shims	744
K24605		K24605	Auxiliary	Cup Shims	744
K24607		K24607	Auxiliary	Cup Shims	744
K24620		K24620	Auxiliary	Cup Shims	744
K24805		K24805	Auxiliary	Cup Shims	744
K24807		K24807	Auxiliary	Cup Shims	744
K24820		K24820	Auxiliary	Cup Shims	744
K25005		K25005	Auxiliary	Cup Shims	744
K25007		K25007	Auxiliary	Cup Shims	744
K25020		K25020	Auxiliary	Cup Shims	744
K25205		K25205	Auxiliary	Cup Shims	744
K25207		K25207	Auxiliary	Cup Shims	744
K25220		K25220	Auxiliary	Cup Shims	744
K91500		K91500	Auxiliary	Tonguewasher	740
K91501		K91501	Auxiliary	Tonguewasher	740
K91502		K91502	Auxiliary	Tonguewasher	740
K91503		K91503	Auxiliary	Tonguewasher	740
K91504		K91504	Auxiliary	Tonguewasher	740
K91505		K91505	Auxiliary	Tonguewasher	740
K91506		K91506	Auxiliary	Tonguewasher	740
K915065		K915065	Auxiliary	Tonguewasher	740
K91507		K91507	Auxiliary	Tonguewasher	740
K91508		K91508	Auxiliary	Tonguewasher	740
K91509		K91509	Auxiliary	Tonguewasher	740

Base	Suffix	Part Number Prefix + Base + Suffix	Part Type	Type	Page No.
K91510		K91510	Auxiliary	Tonguewasher	740
K91511		K91511	Auxiliary	Tonguewasher	740
K91512		K91512	Auxiliary	Tonguewasher	740
K91513		K91513	Auxiliary	Tonguewasher	740
K91514		K91514	Auxiliary	Tonguewasher	740
K91515		K91515	Auxiliary	Tonguewasher	740
K91516		K91516	Auxiliary	Tonguewasher	740
K91517		K91517	Auxiliary	Tonguewasher	740
K91518		K91518	Auxiliary	Tonguewasher	740
K91519		K91519	Auxiliary	Tonguewasher	740
K91520		K91520	Auxiliary	Tonguewasher	740
K91521		K91521	Auxiliary	Tonguewasher	740
K91522		K91522	Auxiliary	Tonguewasher	740
K91524		K91524	Auxiliary	Tonguewasher	740
K91526		K91526	Auxiliary	Tonguewasher	740
K91528		K91528	Auxiliary	Tonguewasher	740
K91530		K91530	Auxiliary	Tonguewasher	740
K91532		K91532	Auxiliary	Tonguewasher	740
K91534		K91534	Auxiliary	Tonguewasher	740
K91536		K91536	Auxiliary	Tonguewasher	740
K91538		K91538	Auxiliary	Tonguewasher	740
K91540		K91540	Auxiliary	Tonguewasher	740
KM16		KM16	Auxiliary	Locknut	739
KM17		KM17	Auxiliary	Locknut	739
KM18		KM18	Auxiliary	Locknut	739
KM19		KM19	Auxiliary	Locknut	739
KM20		KM20	Auxiliary	Locknut	739
KM21		KM21	Auxiliary	Locknut	739
KM22		KM22	Auxiliary	Locknut	739
KM23		KM23	Auxiliary	Locknut	739
KM24		KM24	Auxiliary	Locknut	739
KM25		KM25	Auxiliary	Locknut	739
KM26		KM26	Auxiliary	Locknut	739
KMH10		KMH10	Auxiliary	Locknut	739
KMH11		KMH11	Auxiliary	Locknut	739
KMH12		KMH12	Auxiliary	Locknut	739
KMH13		KMH13	Auxiliary	Locknut	739
KMH14		KMH14	Auxiliary	Locknut	739
KMH15		KMH15	Auxiliary	Locknut	739
KMH2		KMH2	Auxiliary	Locknut	739
KMH3		KMH3	Auxiliary	Locknut	739
KMH4		KMH4	Auxiliary	Locknut	739
KMH4.4		KMH4.4	Auxiliary	Locknut	739
KMH5		KMH5	Auxiliary	Locknut	739
KMH5.6		KMH5.6	Auxiliary	Locknut	739
KMH6		KMH6	Auxiliary	Locknut	739
KMH6.4		KMH6.4	Auxiliary	Locknut	739
KMH7		KMH7	Auxiliary	Locknut	739
KMH8		KMH8	Auxiliary	Locknut	739
KMH9		KMH9	Auxiliary	Locknut	739
MBB10		MBB10	Auxiliary	Lockwasher	739
MBB11		MBB11	Auxiliary	Lockwasher	739
MBB12		MBB12	Auxiliary	Lockwasher	739
MBB13		MBB13	Auxiliary	Lockwasher	739
MBB14		MBB14	Auxiliary	Lockwasher	739
MBB15		MBB15	Auxiliary	Lockwasher	739

Base	Suffix	Part Number Prefix + Base + Suffix	Part Type	Type	Page No.
MBB16		MBB16	Auxiliary	Lockwasher	739
MBB17		MBB17	Auxiliary	Lockwasher	739
MBB18		MBB18	Auxiliary	Lockwasher	739
MBB19		MBB19	Auxiliary	Lockwasher	739
MBB2		MBB2	Auxiliary	Lockwasher	739
MBB20		MBB20	Auxiliary	Lockwasher	739
MBB21		MBB21	Auxiliary	Lockwasher	739
MBB22		MBB22	Auxiliary	Lockwasher	739
MBB23		MBB23	Auxiliary	Lockwasher	739
MBB24		MBB24	Auxiliary	Lockwasher	739
MBB25		MBB25	Auxiliary	Lockwasher	739
MBB26		MBB26	Auxiliary	Lockwasher	739
MBB3		MBB3	Auxiliary	Lockwasher	739
MBB4		MBB4	Auxiliary	Lockwasher	739
MBB4.4		MBB4.4	Auxiliary	Lockwasher	739
MBB5		MBB5	Auxiliary	Lockwasher	739
MBB5.6		MBB5.6	Auxiliary	Lockwasher	739
MBB6		MBB6	Auxiliary	Lockwasher	739
MBB6.4		MBB6.4	Auxiliary	Lockwasher	739
MBB7		MBB7	Auxiliary	Lockwasher	739
MBB8		MBB8	Auxiliary	Lockwasher	739
MBB9		MBB9	Auxiliary	Lockwasher	739
MW10		MW10	Auxiliary	Tonguewasher	739
MW11		MW11	Auxiliary	Tonguewasher	739
MW12		MW12	Auxiliary	Tonguewasher	739
MW13		MW13	Auxiliary	Tonguewasher	739
MW14		MW14	Auxiliary	Tonguewasher	739
MW15		MW15	Auxiliary	Tonguewasher	739
MW16		MW16	Auxiliary	Tonguewasher	739
MW17		MW17	Auxiliary	Tonguewasher	739
MW18		MW18	Auxiliary	Tonguewasher	739
MW19		MW19	Auxiliary	Tonguewasher	739
MW2		MW2	Auxiliary	Tonguewasher	739
MW20		MW20	Auxiliary	Tonguewasher	739
MW21		MW21	Auxiliary	Tonguewasher	739
MW22		MW22	Auxiliary	Tonguewasher	739
MW23		MW23	Auxiliary	Tonguewasher	739
MW24		MW24	Auxiliary	Tonguewasher	739
MW25		MW25	Auxiliary	Tonguewasher	739
MW26		MW26	Auxiliary	Tonguewasher	739
MW3		MW3	Auxiliary	Tonguewasher	739
MW4		MW4	Auxiliary	Tonguewasher	739
MW4.4		MW4.4	Auxiliary	Tonguewasher	739
MW5		MW5	Auxiliary	Tonguewasher	739
MW5.6		MW5.6	Auxiliary	Tonguewasher	739
MW6		MW6	Auxiliary	Tonguewasher	739
MW6.4		MW6.4	Auxiliary	Tonguewasher	739
MW7		MW7	Auxiliary	Tonguewasher	739
MW8		MW8	Auxiliary	Tonguewasher	739
MW9		MW9	Auxiliary	Tonguewasher	739
N-00		N-00	Auxiliary	Locknut	740
N-01		N-01	Auxiliary	Locknut	740
N-02		N-02	Auxiliary	Locknut	740
N-03		N-03	Auxiliary	Locknut	740
N-04		N-04	Auxiliary	Locknut	740
N-05		N-05	Auxiliary	Locknut	740

Base	Suffix	Part Number Prefix + Base + Suffix	Part Type	Type	Page No.
N-06		N-06	Auxiliary	Locknut	740
T45882		T45882	Auxiliary	Cone Shims	745
T45884		T45884	Auxiliary	Cone Shims	745
T45885		T45885	Auxiliary	Cone Shims	745
T45887		T45887	Auxiliary	Cone Shims	745
T50605		T50605	Auxiliary	Cone Shims	745
T50606		T50606	Auxiliary	Cone Shims	745
T50607		T50607	Auxiliary	Cone Shims	745
T50608		T50608	Auxiliary	Cone Shims	745
T50609		T50609	Auxiliary	Cone Shims	745
T50610		T50610	Auxiliary	Cone Shims	745
T50611		T50611	Auxiliary	Cone Shims	745
T50612		T50612	Auxiliary	Cone Shims	745
T50613		T50613	Auxiliary	Cone Shims	745
T50614		T50614	Auxiliary	Cone Shims	745
T50615		T50615	Auxiliary	Cone Shims	745
T50616		T50616	Auxiliary	Cone Shims	745
T50617		T50617	Auxiliary	Cone Shims	745
T50618		T50618	Auxiliary	Cone Shims	745
T50619		T50619	Auxiliary	Cone Shims	745
T50620		T50620	Auxiliary	Cone Shims	745
T50621		T50621	Auxiliary	Cone Shims	745
T50622		T50622	Auxiliary	Cone Shims	745
T50623		T50623	Auxiliary	Cone Shims	745
T50624		T50624	Auxiliary	Cone Shims	745
T50625		T50625	Auxiliary	Cone Shims	745
T50626		T50626	Auxiliary	Cone Shims	745
T50627		T50627	Auxiliary	Cone Shims	745
T50628		T50628	Auxiliary	Cone Shims	745
T50633		T50633	Auxiliary	Cone Shims	745
T50634		T50634	Auxiliary	Cone Shims	745
TAN-128		TAN-128	Auxiliary	Locknut	740
TAN-130		TAN-130	Auxiliary	Locknut	740
TAN-132		TAN-132	Auxiliary	Locknut	740
TAN-134		TAN-134	Auxiliary	Locknut	740
TAN-136		TAN-136	Auxiliary	Locknut	740
TAN-138		TAN-138	Auxiliary	Locknut	740
TAN-140		TAN-140	Auxiliary	Locknut	740
TAN-15		TAN-15	Auxiliary	Locknut	740
TAN-16		TAN-16	Auxiliary	Locknut	740
TAN-17		TAN-17	Auxiliary	Locknut	740
TAN-18		TAN-18	Auxiliary	Locknut	740
TAN-19		TAN-19	Auxiliary	Locknut	740
TAN-20		TAN-20	Auxiliary	Locknut	740
TAN-21		TAN-21	Auxiliary	Locknut	740
TAN-22		TAN-22	Auxiliary	Locknut	740
TAN-24		TAN-24	Auxiliary	Locknut	740
TAN-26		TAN-26	Auxiliary	Locknut	740
TN-065		TN-065	Auxiliary	Locknut	740
TN-07		TN-07	Auxiliary	Locknut	740
TN-08		TN-08	Auxiliary	Locknut	740
TN-09		TN-09	Auxiliary	Locknut	740
TN-10		TN-10	Auxiliary	Locknut	740
TN-11		TN-11	Auxiliary	Locknut	740
TN-12		TN-12	Auxiliary	Locknut	740
TN-13		TN-13	Auxiliary	Locknut	740

TAPERED ROLLER BEARINGS

Base	Suffix	Part Number Prefix + Base + Suffix	Part Type	Type	Page No.
TN-14		TN-14	Auxiliary	Locknut	740
TW065		TW065	Auxiliary	Lockwasher	740
TW100		TW100	Auxiliary	Lockwasher	740
TW101		TW101	Auxiliary	Lockwasher	740
TW102		TW102	Auxiliary	Lockwasher	740
TW103		TW103	Auxiliary	Lockwasher	740
TW104		TW104	Auxiliary	Lockwasher	740
TW105		TW105	Auxiliary	Lockwasher	740
TW106		TW106	Auxiliary	Lockwasher	740
TW107		TW107	Auxiliary	Lockwasher	740
TW108		TW108	Auxiliary	Lockwasher	740
TW109		TW109	Auxiliary	Lockwasher	740
TW110		TW110	Auxiliary	Lockwasher	740
TW111		TW111	Auxiliary	Lockwasher	740
TW112		TW112	Auxiliary	Lockwasher	740
TW113		TW113	Auxiliary	Lockwasher	740
TW114		TW114	Auxiliary	Lockwasher	740
TW115		TW115	Auxiliary	Lockwasher	740
TW116		TW116	Auxiliary	Lockwasher	740
TW117		TW117	Auxiliary	Lockwasher	740
TW118		TW118	Auxiliary	Lockwasher	740
TW119		TW119	Auxiliary	Lockwasher	740
TW120		TW120	Auxiliary	Lockwasher	740
TW121		TW121	Auxiliary	Lockwasher	740
TW122		TW122	Auxiliary	Lockwasher	740
TW124		TW124	Auxiliary	Lockwasher	740
TW126		TW126	Auxiliary	Lockwasher	740
TW128		TW128	Auxiliary	Lockwasher	740
TW130		TW130	Auxiliary	Lockwasher	740
TW132		TW132	Auxiliary	Lockwasher	740
TW134		TW134	Auxiliary	Lockwasher	740
TW136		TW136	Auxiliary	Lockwasher	740
TW138		TW138	Auxiliary	Lockwasher	740
TW140		TW140	Auxiliary	Lockwasher	740

TIMKEN

The Timken team applies their know-how to improve the reliability and performance of machinery in diverse markets worldwide. The company designs, makes and markets high-performance mechanical components, including bearings, gears, chain and related mechanical power transmission products and services.

www.timken.com

Price: USD \$75

Stronger Commitment. Stronger Value. Stronger Worldwide. Stronger Together. | Stronger By Design.